

Ethnic constructs in antiquity: the role of power and tradition

Derks, Ton (Ed.); Roymans, Nico (Ed.)

Veröffentlichungsversion / Published Version

Sammelwerk / collection

Zur Verfügung gestellt in Kooperation mit / provided in cooperation with:

OAPEN (Open Access Publishing in European Networks)

Empfohlene Zitierung / Suggested Citation:

Derks, T., & Roymans, N. (Eds.). (2009). *Ethnic constructs in antiquity: the role of power and tradition* (Amsterdam Archaeological Studies, 13). Amsterdam: Amsterdam Univ. Press. <https://nbn-resolving.org/urn:nbn:de:0168-ssoar-271832>

Nutzungsbedingungen:

Dieser Text wird unter einer CC BY-NC-ND Lizenz (Namensnennung-Nicht-kommerziell-Keine Bearbeitung) zur Verfügung gestellt. Nähere Auskünfte zu den CC-Lizenzen finden Sie hier:

<https://creativecommons.org/licenses/by-nc-nd/4.0/deed.de>

Terms of use:

This document is made available under a CC BY-NC-ND Licence (Attribution-Non Commercial-NoDerivatives). For more information see:

<https://creativecommons.org/licenses/by-nc-nd/4.0>

Ton Derks & Nico Roymans [eds]
Archaeological Studies

13
Amsterdam

AMSTERDAM UNIVERSITY PRESS

THE ROLE OF
POWER AND TRADITION

Ethnic Constructs in Antiquity



Ethnic Constructs in Antiquity

AMSTERDAM ARCHAEOLOGICAL STUDIES 13

Editorial Board:

Prof. dr. E.M. Moormann

Prof. dr. W. Roebroeks

Prof. dr. N. Roymans

Prof. dr. F. Theuvs

Other titles in the series:

N. Roymans (ed.): *From the Sword to the Plough*
Three Studies on the Earliest Romanisation of Northern Gaul
ISBN 90 5356 237 0

T. Derks: *Gods, Temples and Ritual Practices*
The Transformation of Religious Ideas and Values in Roman Gaul
ISBN 90 5356 254 0

A. Verhoeven: *Middeleeuws gebruiksraadewerk in Nederland (8e – 13e eeuw)*
ISBN 90 5356 267 2

F. Theuvs / N. Roymans (eds): *Land and Ancestors*
Cultural Dynamics in the Urnfield Period and the Middle Ages in the Southern Netherlands
ISBN 90 5356 278 8

J. Bazelmans: *By Weapons made Worthy*
Lords, Retainers and Their Relationship in Beowulf
ISBN 90 5356 325 3

R. Corbey / W. Roebroeks (eds): *Studying Human Origins*
Disciplinary History and Epistemology
ISBN 90 5356 464 0

M. Diepeveen-Jansen: *People, Ideas and Goods*
New Perspectives on 'Celtic barbarians' in Western and Central Europe (500-250 BC)
ISBN 90 5356 481 0

G. J. van Wijngaarden: *Use and Appreciation of Mycenaean Pottery in the Levant, Cyprus and Italy*
(ca. 1600-1200 BC)
The Significance of Context
ISBN 90 5356 482 9

F.A. Gerritsen: *Local Identities*
Landscape and community in the late prehistoric Meuse-Demer-Scheldt region
ISBN 90 5356 588 4

N. Roymans: *Ethnic Identity and Imperial Power*
The Batavians in the Early Roman Empire
ISBN 90 5356 705 4

J.A.W. Nicolay: *Armed Batavians*
Use and significance of weaponry and horse gear from non-military contexts in the Rhine delta (50 bc to ad 450)
ISBN 978 90 5356 253 6

M. Groot: *Animals in ritual and economy in a Roman frontier community*
Excavations in Tiel-Passewaaij
ISBN 978 90 8964 0 222

Ethnic Constructs in Antiquity

THE ROLE OF POWER AND TRADITION

EDITORS

TON DERKS & NICO ROYMANS

AMSTERDAM UNIVERSITY PRESS



ISO 9706

This book meets the requirements of ISO 9706: 1994, Information and documentation – Paper for documents – Requirements for permanence.

Cover illustration: Reverse of an Augustan *denarius* (RIC 201a), showing a barbarian in Germanic dress who hands over a child as hostage to emperor Augustus (cf. Roymans this volume fig. 9).

Cover design: Kok Korpershoek, Amsterdam

Lay-out: Bert Brouwenstijn, ACVU Amsterdam

ISBN 978 90 8964 078 9

NUR 682

© Amsterdam University Press, Amsterdam, 2009

All rights reserved. Without limiting the rights under copyright reserved above, no part of this book may be reproduced, stored in or introduced into a retrieval system, or transmitted, in any form or by any means (electronic, mechanical, photocopying, recording, or otherwise), without the written permission of both the copyright owner and the editors of this book.

IN MEMORY OF

DICK WHITTAKER

(25 OCTOBER 1929 - 28 NOVEMBER 2008)

C O N T E N T S

Introduction <i>Ton Derks / Nico Roymans</i>	I
Ethnic expression on the Early Iron Age and Early Archaic Greek mainland Where should we be looking? <i>Catherine Morgan</i>	11
The Ionians in the Archaic period. Shifting identities in a changing world <i>Jan Paul Crielaard</i>	37
From Athenian identity to European ethnicity. The cultural biography of the myth of Marathon <i>Hans-Joachim Gehrke</i>	85
Multi-ethnicity and ethnic segregation in Hellenistic Babylon <i>Bert van der Spek</i>	101
The Galatians in the Roman Empire. Historical tradition and ethnic identity in Hellenistic and Roman Asia Minor <i>Karl Strobel</i>	117
Material culture and plural identity in early Roman Southern Italy <i>Douwe Yntema</i>	145
Foundation myths in Roman Palestine. Traditions and reworkings <i>Nicole Belayche</i>	167
Ethnic discourses on the frontiers of Roman Africa <i>Dick Whittaker</i>	189
Cruptorix and his kind. Talking ethnicity on the middle ground <i>Greg Woolf</i>	207
Hercules and the construction of a Batavian identity in the context of the Roman empire <i>Nico Roymans</i>	219
Ethnic identity in the Roman frontier. The epigraphy of Batavi and other Lower Rhine tribes <i>Ton Derks</i>	239
Grave goods, ethnicity, and the rhetoric of burial rites in Late Antique Northern Gaul <i>Frans Theuvs</i>	283
The early-medieval use of ethnic names from classical antiquity. The case of the Frisians <i>Jos Bazelmans</i>	321
Index of names and places	339
List of contributors	343

Introduction

Ton Derks / Nico Roymans

The present volume derives from two meetings that were organised in the framework of the research programme entitled *The Batavians. Ethnic identity in a frontier situation*. This programme, launched by the Archaeological Centre of the VU University Amsterdam, was funded by the Netherlands Organisation for Scientific Research (NWO) and ran between 1999 and 2005. Both at the beginning and the end of the project's term, small-scale expert meetings were organised in order to present the results of the research group to an international audience. The first meeting was a two-day round table discussion held under the title of the present volume at the VU University Amsterdam in December 2001. Its chronological and thematic scope ranged from Archaic Greece to Early Mediaeval Western Europe. In December 2004, on the occasion of a large temporary exhibition focussing on the history and archaeology of the Batavi, as well as on the impact of the 'Batavian myth' on Dutch national history and popular culture from the 16th century onwards, the Museum Het Valkhof at Nijmegen hosted a one-day workshop on *Tribal identities in the frontier provinces of the Roman empire*. Papers were read by Karl Strobel, Dick Whittaker and Greg Woolf as well as the present authors. All papers presented at these three days have been gathered in the present volume. A further article, written by Bert van der Spek, was added in the editorial process.

Both the round table discussion and the workshop aimed for an interdisciplinary, comparative exploration of the complex themes of ethnicity and ethnogenesis in the ancient world, such with reference to recent discussions in the social and historical disciplines. The volume's starting point is the current view of ethnicity as a subjective, dynamic construct that is shaped through interaction with an ethnic 'other'. If ethnicity was the central focus of both meetings, we were well aware that ethnic identities cannot be studied in isolation from other forms of identity. The thirteen case studies collected in this volume demonstrate that ethnic identity is often related to questions of power, religion, law, class and gender. Ethnicity may be expressed through language, material culture or social practices. Given these complex interrelationships, it will come as no surprise that, despite shared views on the concept of ethnicity and fruitful exchanges of ideas during each of the meetings, some areas of disagreement between the individual contributors have remained. The following pages aim to draw some general conclusions whilst making explicit and bringing up for discussion the most important differences of opinion or approach. It is hoped that these lines may thus serve not just as a general introduction to the volume, but as a stimulus for further discussion in the future.

ETHNIC CONSTRUCTS, POWER AND TRADITION

Ethnic identities are always constructed in close association with political systems. It is politics that define ethnicity, not vice versa. Ethnic affiliation may be expressed at different scales of social organisation. At the highest level, there are macro-ethnic formations (*Großstämme*) such as Ionians and Achaians, or Gauls and Germans. At a local or regional level, smaller social groups may be discerned that coincide with localised political communities (e.g. *poleis*, *civitates*, or tribes). Despite frequent claims by ethnic groups to the contrary, all ethnic formations are intrinsically unstable and dynamic over time. Much of this dynamism is to be understood in close association with conflict, violence and changing constellations

of power. Expanding or collapsing empires, for instance, create new – or bring an end to old – ethnic groups. But smaller formations such as tribes too, are continuously subject to ethnic change. In this context, Reinhard Wenskus' concept of a *Traditionskern* ('nucleus of tradition') still seems valuable today. Essentially, the model assumes the hand of the political elite in conferring ethnic traditions onto a much larger, and sometimes quite heterogeneous, population group. However, as Roymans has argued earlier,¹ besides the small aristocratic group that Wenskus wanted to see as the sole keepers and propagators of the group's core values, other social agents may be important contributors to the group's ethnicity as well (e.g. encroaching empires or lower social groups within the tribe). With this qualification in mind, we still believe the model has strong explanatory power. Hence the title of the first symposium and the present volume.

ETHNICITY AND LANGUAGE

Communication is essential for the continued existence of any community; ethnic communities are no exception. Communities can call on different media in order to convey their messages: the language of the spoken or written word, other sets of symbolic codes and/or collective rituals.² In studies of ethnicity, particular weight is often attributed to language. An example from this volume is Strobel's contribution on the Galatians of Central Asia Minor. His paper revolves around the central argument that a common and distinct language was the key to the perseverance of the Galatians' self-consciousness as an ethnic group. His contribution invites a few comments on the importance of language for ethnic constructs. Firstly, we have to acknowledge that, if we did not have the literary evidence at our disposal, we would probably not have been able to identify the Galatians as an ethnic group at all. As it happens, their aristocratic leaders quickly adopted a Hellenistic lifestyle, learned Greek as a second language and became full members of the Hellenistic koine that characterised the period. As archaeologists have been unable to identify items of La Tène style material culture typical of the immigrants' supposed homeland in the Galatian area, the Galatians have remained invisible in the material record. Secondly, without wanting to detract from the importance of a shared language for the reproduction of group identity, the extreme example of the Galatians should not lead us to conclude that language always played a critical role in the self-consciousness of ethnic communities. Ethnic groups may change their language without affecting the group's ethnic identity. In the frontier zone of the Roman empire, the Batavians provide an example of this. In their correspondence with family and friends at home, Batavian auxiliary soldiers, we have argued elsewhere,³ used the *lingua franca* of the Roman army rather than their native tongue. We cannot exclude, of course, that the switch to Latin was made only for communication in writing. But given the large scale recruitment for the Roman auxilia, the extraordinarily long term of service in the Roman army, and the high proportion of veterans who, after completion of their stipendia, returned home,⁴ we expect the impact on the spoken word within the receiving communities to have been dramatic and the erosion of the native language quick and radical. What these examples may prove is that as far as language is concerned, two opposing scenarios are equally possible: whereas enclaves of ethnic groups with a mother tongue different from their social environment may strive to preserve their language as a sign of their ethnic identity (Galatians), for other ethnic groups preservation of their mother tongue may be secondary to the reproduction of their ethnic identity (Batavi).

¹ Roymans 2004, esp. 3 and 258 f.

² Cohen 1985.

³ Derks/Roymans 2002.

⁴ Derks/Roymans 2006; Nicolay 2007.

Archaeology's primary object of research is material culture. If the discipline has seen a long tradition of interpreting types of material culture as cultural markers of ethnic groups, thanks to the work of Siân Jones and Sebastian Brather amongst others,⁵ today most archaeologists are well aware of the inherent problems associated with such direct lines of thinking. However, the contributions gathered in this volume also show that opinions still differ widely on the important question of what the study of material culture has to contribute to our reconstructions of ethnic identities. While some authors are skeptical or markedly negative about its potential, others take a more optimistic stance.

If we have to believe Strobel and Whittaker, archaeologists have little to contribute to the study of ethnicity. Arguing from the example of the Galatians, Strobel pleads for a strict distinction between ethnic and cultural identity. According to Strobel, '[b]oundaries of culture and ethnic identity do not coincide. Just as ethnic identity can be preserved in spite of cultural changes and dominating cultural influences, cultural contents can vary without any critical consequence for the maintenance of the ethnic group and its defining boundaries. Continuity of ethnic identity is not to be equated with a continuity of culture or even material culture.' Whittaker, for his part, goes one step further and claims, looking back at recent discussions on the issue of Romanisation, that '[a]rchaeology cannot dig up ethnicity'.

Theuws's contribution on grave inventories from 4th- and 5th-century Northern Gaul fits in well with recent critical approaches. His paper is foremost an attempt to debunk some of the deeply rooted ethnic interpretations of Late Roman and Early Mediaeval funerary archaeology. He concludes that the objects found in grave assemblages of the allegedly 'Germanic' invaders of Late Antique and Early Mediaeval Northern Gaul must relate to age, gender or lifestyle rather than ethnicity. According to him, '[w]ritten and spoken language is not the only medium for constructing identities; others are gestures and material culture. The way that people dress in specific situations, that pots are shaped, food is eaten, houses are built, settlements are organised and landscape is shaped may convey messages about the identity – including the ethnic identity – of a person, a family, or a group. However, the symbolism is complex and, by definition, open to multiple interpretations, in both the past and the present.' In conclusion he states that '[t]rying to understand the rhetoric of material culture in relation to the creation of identities is a hazardous undertaking'.

Morgan and Crielaard are more optimistic about what studies of material culture have to offer to reconstructions of group identities. Much of the material culture that is the subject of their studies is seen as an expression of a particular lifestyle (*habitus* for Morgan) that is part of a group identity, where ethnic and other forms of social status interplay. Following changing views of state formation in the Archaic Eastern Mediterranean, they recognise that political communities were in practice tiered rather than mutually exclusive forms of association and so their papers focus on 'multiple registers in which the *habitus* was constructed in many areas of Greece' (Morgan). As they deal with periods and places where there was no overarching bureaucracy to provide classifications of groups, Morgan recognises, 'much depends on modern assessments of diverse source material'. Under these circumstances, the approach adopted as it is described by Morgan, comes down to 'an unpacking of certain forms of regional complexity' and 'seeking case by case to identify and predict points of tension where *identity* would be likely to have become a particularly important issue' (our emphasis). Noteworthy here is the deliberate omission of the distinction between 'cultural' and 'ethnic' identity.

Our own position would be more in line with Jonathan Hall's, who argued that 'there can be no archaeology of ethnicity among societies who have left us no record',⁶ or with Koen Goudriaan's, who, in his study of Greek communities in Ptolemaic Egypt, stated that '[e]thnicity and culture are two different things'

⁵ Jones 1997; Brather 2000, 2004.

⁶ Hall 2002, 24.

and concluded that for ‘the perpetuation of ethnic boundaries the maintenance of only a few culture differences suffices’.⁷ If ethnicity is a form of *self*-ascription that may vary across time and space, and that may be foregrounded only during particular forms of social interaction, some sort of linguistic evidence seems to be a pre-requisite for accessing the emic viewpoint. The challenge for the archaeologist lies in trying to assess exactly which tokens were ethnically laden and under what circumstances precisely. The cases presented by Theuws and Strobel, however, may serve as warnings of the traps and pitfalls we may come across when trying to talk about ethnicity on the (sole) basis of material culture.

ETHNICITY AND EMPIRES

Empires produce and cultivate new ethnic communities, while denying, marginalising or even destroying existing ones. The engine behind these processes may be different. Firstly, ‘on the violent edge of empire’, existing ethnic groups may be annihilated or split up by the imperial power, while among the people in the frontier zones themselves, in reaction to the imperial presence, ethnic consciousness may be enhanced and new forms of ethnic self-ascription aroused.⁸ Secondly, the conquest of new territories always asks for some form of physical presence by the empire’s centre of power. This gives rise to the coming into being of expatriate communities of the invading power in the frontier zones of the empire. Conversely, the subsequent integration of the autochthonous population into the framework of empire and the social mobility that goes with it, ultimately creates other pockets of ethnic groups across the imperial territory. The modalities and the scale with which this happens varies according to historical context. Finally, next to some form of physical presence, empires also need a central bureaucracy that inventories the imperial territory and its resources, including the subject population. In the process of categorisation, existing ethnic groups may be ‘forbidden to exist’, whereas conversely new ethnic identities may be imposed on others.

The dynamism of ethnicity in the frontier zones of empires is perhaps best exemplified by the number and bewildering array of ethnonyms that have been preserved for the frontiers of the Roman empire.⁹ The rationale behind the disappearing and appearing of tribes during the centuries of its existence is not always clear, but informed by anthropological models Whittaker argues that in most cases this may be best explained by changing ethnic self-ascription. Concrete examples of imperial destruction of ethnic names are few, of which the North African Nassamones and the Lower Rhine Eburones are two.

Examples of small-scale diaspora spread across empires are discussed by Van der Spek and Derks. In his survey of Hellenistic Mesopotamia, Van der Spek draws our attention to pieces of evidence which offer rare glimpses of the living conditions of ethnic enclaves in the empires of Alexander the Great and the Seleucids. In the Alexandrian colony of Charax, at the head of the Persian Gulf, so Pliny tells us, Alexander ordered that one district of the town – called Pellaeum, after his native town Pella – be reserved exclusively for Macedonians. And although even under his immediate successors the Macedonians who lived in Babylon were deported to Seleucia on the Tigris, the new ‘town of kingship’ of the Seleucid empire, a Greek community was established again at Babylon in the early 2nd century BC. As these examples show, the development of ethnic enclaves is often directly related to violent military conquest rather than to spontaneous individual action and free will. The boundaries between the ethnic enclaves and the hosting urban communities may have been physical, legal or political. In the borough of Pella at Charax, spatial separation of the Macedonian settlers from the rest of the town may have ultimately resulted in ethnic segregation. In Seleucid Babylon on the other hand, a Greek community was set apart

⁷ Goudriaan 1988, ii.

⁹ Cf. Roymans 2004, ch. 3; Whittaker this volume.

⁸ Cf. Ferguson/Whitehead 1992.

first of all politically, by admission to the local community of *politai* through the granting of citizenship. If, in contrast to the Macedonians, the Greeks in Babylon did not form an ethnic township but were living across the town (something we do not know as the living quarters of the city are hardly excavated), the Babylonian sources suggest they were easily recognisable by different habits, the practice of anointing the body with oil when visiting the gymnasium being mentioned as a case in point.

Ethnic communities of expatriates are also a regular phenomenon in the Roman empire. Well represented are groups of tradesmen and soldiers, for whom the diaspora was a kind of natural habitat. Until well into the 2nd century AD, members of these ethnic associations were often *peregrini* (non-citizens). Derks cites the example of the *cives Remi* originating from the area around modern Reims and living at Xanten on the Rhine. After having survived some unidentified troubles, they joined together to consecrate a temple to one of their patron gods, whilst thanking the emperor for their protection. Ethnic groups in the auxiliary units of the Roman army were more constrained. Although they were perfectly integrated into the Roman military community at large and participated in the official army religion, as Derks and Whittaker show, they occasionally joined together to act on their own behalf, especially for the worship of the patron deities of their ethnic communities. Following Rome's general attitude towards religious affairs, Roman army authorities allowed such collective acts of worship by ethnic sections of the Roman auxilia as an addition to official army religion rather than as a replacement of it. Within the army (and especially within the auxilia) ethnic sentiments were thus inevitably always present in the background and, in times of crisis, could be easily mobilised against the empire. To what this could lead, is clearly exemplified by the revolts of Batavi and Mauri.

To put the above in a slightly larger context, it may be useful to briefly focus our attention on one particular form of ethnic club which has not been discussed in this volume, namely that of the *conventus civium Romanorum*, the associations of Roman citizens in a particular town or province of the empire.¹⁰ These associations, predominantly consisting of, again, tradesmen and businessmen, were intended for defending their interests and privileges in interactions with the host communities and protecting them against potential attacks. While their privileged position was perhaps comparable to that of the Macedonian communities in the Alexandrian empire, they differed fundamentally regarding their frames of reference. The citizenship of the *politai* in Babylon was strictly local and confined to the town of Babylon itself. The *cives Romani*, however, whilst being organised as local clubs, symbolically referred to a community that was scattered across the entire Roman empire. Judging by their legal position and its frame of reference rather than their (sometimes very heterogeneous) geographical backgrounds, such 'communities of Roman citizens' are not essentially different from other ethnic diaspora. As Whittaker points out, such a conceptualisation of Roman ethnicity may be of the highest importance for the ongoing debate on the issue of Romanisation: it takes us beyond the polemics of the cultural implications of Romanisation and focuses again on the question of how such a huge and ethnically heterogeneous empire managed to function as a successful symbolic community over such a long timespan.

Several papers in the volume discuss the impact of imperial categorisation on the ethnic map of the frontier zones of empires (Derks, Whittaker, Bazelmans). The Frisian case, presented by Bazelmans, provides the most extreme example. Bazelmans argues strongly for an archaeological discontinuity in the habitation of present-day Friesland between the 3rd and 5th centuries. Since there is also a gap of about three centuries between the latest Roman and earliest mediaeval sources that mention Frisians, he concludes that in the Merovingian period there would have been no groups left in the area who called themselves Frisians, and suggests that the name Frisia was re-introduced in the area when it became part of the frontier of the Frankish empire in the 7th century AD. Drawing on the traditions of classical Roman ethnography, the Frankish imperial elite was thus able to bridge a gap of several hundreds of years and, as an external power,

¹⁰ Van Andringa 2003

succeeded in re-vitalising an old ethnonym with a new content. The initiative may have been part of a conscious Merovingian strategy to reintroduce Roman names to enforce their claims on landed property which originally belonged to the Roman state. Paradoxically, the externally imposed ethnic self-identification ultimately became entrenched among inhabitants of present-day Friesland to such an extent that in the popular press Bazelmans's recently published Dutch-language article has become most controversial!

As the Frisian case demonstrates, continuity of ethnic names does not necessarily coincide with an unbroken tradition of habitation. Whittaker presents other examples of this from the Roman frontier of North Africa, where in large areas nomadism was the rule rather than habitation in permanent settlements. The Romans 'had no understanding of the nomadic concept of possession of *terre de parcours* nor of territory as "the science of movement"', he writes, and continues 'I am not sure that modern historians of Roman Africa have done much better'. According to Whittaker, this particular way of life may explain the occurrence of one and the same ethnonym at places that sometimes lie at enormous distances in time and space from each other. The examples also underline that, determined by modes of existence, the association of ethnic groups with a particular territory may be looser than is commonly assumed on the basis of nation-state models.

MULTIPLE ETHNIC IDENTITIES AND THE INDIVIDUAL

As we saw earlier, ethnic affiliation may be expressed at different scales of social organisation. According to context, individuals may thus identify with different ethnic groups of varying amplitude. Such identifications were tiered rather than mutually exclusive. Greeks, for instance, 'had many different loyalties, of which being a Hellene was only one, and usually less important than loyalty to family, village, polis or to wider, ethnic groups (such as Arcadians)', as Whittaker reminds us. 'Context was all important as to which label was claimed', he continues. The issue of multiple ethnic identity and the individual is raised in several papers.

In his discussion of a rich grave inventory from Mesagne in the Southern Italian district of Salento, tentatively dated to the 170s BC, Yntema tries to unravel the distinct group networks to which the deceased may have belonged. Drawing on Ennius, the famous contemporary Salentine poet who described his membership of multiple overlapping identity groups with the famous words 'he had three hearts (*tria corda*) since he spoke Greek, Oscan and Latin', Yntema concludes that the various sets of objects that accompanied the anonymous deceased (Rhodian wine amphorae, golden funerary crown and black gloss dinner set of Brindisi ware) are strong pointers of his reception in social networks of varying amplitude, only some of which may be described as ethnic. Given the choice of the location for the grave in the small, declining settlement of Mesagne rather than in boomtown Brundisium, the springboard to Greece, Yntema assumes that in the rapidly changing world of the time the deceased and his relatives deliberately stressed the family's local roots in the Salentine peninsula.

Yntema's 'thick description' of the Mesagne burial is valuable in itself, but (as the papers by Morgan and Crielaard show), also exceptional: in most other cases historical information of comparable detail is missing. For the issue of multiple ethnic identity more potential is to be expected from epigraphic data, as inscriptions can provide an unparalleled source for research into subjective and context based constructions of ethnicity at the level of the individual. As the papers by Crielaard and Derks show, the individual abroad identified himself above all with his local home community, i.e. the polis or the *civitas*. In the 6th century BC, East Greeks visiting temples in Egypt at Abu Simbel or in Naucratis in the Nile delta left their names, followed by references to their polis, on statues and small votive objects. Similarly, Roman auxiliary soldiers from the Lower Rhine who died abroad, normally referred to their home *civitas* (*natione Batavus, Ubius*) rather than the province (*Germanus*). A point of discussion is to what extent the overarching labels of an Ionian or Germanic identity were used in a self-ascriptive sense: while Derks presents some evidence for its adoption among *Germani* in Rome and Britain, apart from the Homeric Hymn,

all references to an Ionian identity are made by non-Ionian contemporaries, such as those from Anatolia. Perhaps one of the conclusions we may draw is that since the political aspect of these macro-groups was weakly developed and only marginally present in the everyday experiences of most individuals, ethnic identity on the highest scale of identification was much less important to the people concerned.

The evidence presented by Crielaard and Derks is significant in at least one more sense: it points out, if necessary, that ethnicity is not just a matter of the aristocratic core of politicised groups such as *poleis* and *civitates*. Lower strata in society comprising mercenaries or tradesmen in the Egyptian case or auxiliary soldiers of the Roman army in the Lower Rhineland, were no less active agents in the continuous negotiation of ethnic identities. Their involvement contributed no less to the creation and reproduction of ethnic stereotypes.

ETHNICITY AND CLASSICAL ETHNOGRAPHY

Research on ethnicity in the ancient world tends to be textually driven, and, in our view, rightly so. This does not preclude, however, that the way in which such textual evidence is incorporated in the analysis may become a matter of concern, as it has indeed to several authors in this volume. In her strongly methodological paper on the Archaic Greek mainland, Morgan rightly observes that ‘attention has focused less on ethnicity as the *process* of situational identity creation and negotiation (...), and more on the *outcomes* of that process’ (our emphasis). Taking the rich documentation for Roman North Africa as an example (for which more than 400 ethnic names have been registered!), it becomes abundantly clear that, with the same tribal names disappearing and popping up again at huge distances in time and space from each other, a simple reliance on the outcome, i.e. on the recorded names, will not suffice. As Whittaker said, pinpointing names onto a map: that is not how ethnicity works.

Several complementary ways forward have been suggested. Morgan forces us ‘to re-examine past assumptions about the complex of relations from which individual communities were constituted’ and suggests examining the longer term history of identity construction. Woolf calls for a re-appreciation of ancient ethnographic accounts. Regarding their truth-value, scholars have taken widely differing positions, treating them as essentially fictional at one end of the spectrum, to assuming a broad veracity at the other. In the wake of postcolonial thinking, recent decades have seen the development of a strong current of cultural constructionist readings of ancient ethnography. With a certain amount of scepticism and inspired by parallels with early modern ethnographic writing in the New World, Woolf instead argues against such deprecation of classical ethnographic writing and draws our attention to ‘the concept of the middle ground, a particular form of stable co-existence in a colonial situation.’ Archaeologists will know these fields as the places of creative hybridisation, but for the generation of ancient ethnographic knowledge ‘the processes of investigation, documentation and systematisation that lie behind our largely classical accounts of ethnic identity in temperate Europe’ have hardly been explored, and certainly far less than the texts that resulted from them. In trying to form an image of these processes, Woolf focuses on men like the Frisian Cruptorix, a returned veteran of the Roman army who ‘passed back and forward between societies, becoming to some extent bi-cultural as well as bi-lingual’. As the ethnographer’s informants, these transcultural mediators translate the details of the local culture to the world of the ethnographer and his audience.

ETHNICITY, FOUNDATION MYTHS AND SANCTUARIES

All authors in the volume agree that ethnic communities cannot exist without tracing their origins back to some point in the past. However, this mythical origin of a society’s core group is no fixed given, but is subject to manipulation in the service of the present. As a result of changing constellations of power,

it can be changed and accommodated according to the new circumstances. This is what Gehrke calls 'intentional history' (*intentionale Geschichte*). Such accommodations of the origin myths of ethnic groups are discussed by Gehrke, Belayche, Roymans and Derks. Thanks to the rich documentation for the construction of Athenian identity in the aftermath of the Persian wars, Gehrke is able to present a detailed example of how communities, through ingenious interweaving of mythological and historical information, may have succeeded in the endeavour to present convincingly an account of the past that suited the needs of the present. For the Roman East, Belayche draws the attention to the different ways in which urban communities in Judaea re-shaped their past in a reaction to Roman imperialism: following the foundation of Colonia Aelia Capitolina, the town's traditional myths were relegated to the margin to make way for Rome's classical myths of origin, now prominently displayed on local coin emissions, whereas Judaeian towns with municipal status largely kept their Hellenistic myths of origin. Similarly, Derks assumes that in the colonies of the Roman West (Cologne, Xanten) mythical cycles of the former tribal groups were marginalised and in the end made way for the imperial ideology of descent associated with the foundation of Rome.

To the archaeologist, the great sanctuaries of civic religion, as well as the meeting places of 'international' cult communities (*koina*), offer perhaps the best possibilities for gaining access to ethnic constructs of the past at different scales of social organisation. These sites constitute the concrete anchoring points in the landscape where the polity's core values – as exemplified in its tradition of origin – were transmitted to the wider community through recitals, dramatic performances and collective rituals. Judging by the widespread phenomenon of large scale public investment in the monumentalisation and embellishment of civic sanctuaries and their amenities, they functioned as embodiments of the local identity par excellence. This, however, also made them vulnerable to manipulation by those wanting to rewrite history. The most extreme form of this are attempts by warring parties to assault and destroy the enemy's most important sanctuaries, examples of which are cited by Crielaard.

The role of sanctuaries in the construction of ethnic identity is explicitly discussed by Crielaard, Strobel and Roymans. By placing the waxing and waning of local and supra-local sanctuaries in East Ionia in the context of regional political developments, Crielaard concludes that, after an initial dominance of local over supra-local or regional identity, a nascent East Ionian identity gained importance in the 6th century BC, especially in the time of the Lydian and Persian expansions. The Persian wars brought a dramatic shift in the balance of power, which, according to Crielaard, must have forced the East Ionians to rigorously rewrite their tradition. The introduction of the Roman imperial cult at Galatian sanctuaries in Pessinous, Ankyra and Tavium in the Early Imperial period provides another example of the important role of sanctuaries in the reproduction of local and supra-local identities, as well as their flexible accommodation to changed balances of power. In his final discussion of the Hercules cult of the Lower Rhine area, Roymans points out the importance of rites associated with the human life cycle. The initiation rites of young males, partly fulfilled within the precincts of the Batavian sanctuaries such as that at Empel and archaeologically visible in the prominent deposition of weaponry and coins, provided an important stage for the transmission of the core values to the entire male population of Batavian society.

ETHNICITY AND GENDER

The papers gathered in this volume give remarkably little attention to the role of women in the construction of ethnic identities. If authors are explicit about gender, it is males who dominate the discussion. Warriors and mercenaries figure in the papers by Crielaard, Strobel and Roymans, whereas their 'civilised' counterparts, the ethnic soldiers of the Roman army, are prominently present as agents of ethnicity in those by Whittaker and Derks. If the battlefield may be associated with men, women play important binding roles in terms of procreation and marriage. This is true in mythology as much as in

real life. There is, for instance, a striking difference between the sexes in origin myths: whereas founding heroes or ancestor gods of ethnic communities are generally male, females, especially kings' daughters, often play an important role in constructing new lines of descent or explaining fusion between ethnic groups. According to the standard pattern in origin myths of royal lineages in the frontier of the Roman North, for instance, Hercules, writes Roymans, sires a son by the daughter of a local king, and the son subsequently becomes eponymous for a city or ancestor of a people. In real life, in situations of ethnic polarisation between groups, women may play a similar diplomatic function. According to Whittaker, 'exogamy is the most effective destroyer of ethnic boundaries, even if it also encourages greater strategic manipulation of ethnicity'. If ethnicity is particularly relevant in politicised contexts, the centrality of such contexts in much research may explain why the role of women has been underrepresented so far. In line with their different gender roles, we would expect men and women to have different ethnic markers.¹¹ Engendering ethnicity may be one of the tasks for future research on the topic.

We wish to express our gratitude to all authors for their contribution to what have been two most inspiring meetings. All discussions took place in a pleasant, open-minded and constructive atmosphere. Although we initially planned to publish the papers in the short term, things developed differently. As a result of the first author of these lines acquiring a permanent position at VU University, the editorial process had to be drawn out over a much longer period of time than had been foreseen. We are convinced, however, that the volume has not lost its topicality and wish to thank the authors for their patience and, in many cases, their willingness to update their papers.

Finally, it is our pleasant duty to hereby thank all who have contributed to the success of this project. The Netherlands Organisation for Scientific Research and VU University facilitated the first meeting in Amsterdam. The Valkhof Museum in Nijmegen, and especially its director Marijke Brouwer, deserves our gratitude for hosting the second meeting. Annelies Koster and Louis Swinkels were most helpful in ensuring the smooth and successful running of this event. Our gratitude also goes to Luuk de Blois, who willingly accepted the invitation to chair the discussions. In preparing the papers for the press, the help and professional experience of Bert Brouwenstijn, who was responsible for the final layout of the volume, has been indispensable. Paul Beliën (Geld- en Bankmuseum, Utrecht) and Louis Swinkels helped us out with literature and images we would have been unable to find otherwise. Annette Visser (Auckland, New Zealand) undertook the painful task of translating or correcting the English of most of the contributions by non-English speaking authors. Finally, we thank the staff of Amsterdam University Press, in particular Jeroen Sondervan, for their patience and help in the final stage of production. We would like to devote the last lines of this introduction to our academic colleague and friend Dick Whittaker. While wrapping up the editing of this volume, we received the sad news of the fatal illness which had struck him in his country home in Southern France. On November 28, 2008, Dick Whittaker passed away. We deeply regret that he did not survive to see the final publication of this volume. The academic world has lost in him a great scholar and a most congenial colleague. This volume is dedicated to his memory.

Amsterdam
December 2008

¹¹ Hodder 1982.

REFERENCES

- Brather, S., 2000: Ethnische Identitäten als Konstrukte der frühgeschichtlichen Archäologie, *Germania* 78, 139-177.
- Brather, S., 2004: *Ethnische Interpretationen in der frühgeschichtlichen Archäologie. Geschichte, Grundlagen und Alternativen*, Berlin (Ergänzungsbände zum Reallexikon der Germanischen Altertumskunde 42).
- Cohen, A.P., 1985: *The symbolic construction of community*, Chichester/London.
- Derks, T./N. Roymans, 2002: Seal-boxes and the spread of Latin literacy in the Rhine delta, in A.E. Cooley (ed.), *Becoming Roman, writing Latin? Literacy and epigraphy in the Roman west*, Portsmouth RI (Journal of Roman Archaeology, suppl. ser. 48), 87-134.
- Ferguson, R.B./N.L. Whitehead, 1992: The violent edge of empire, in N.L. Whitehead/R.B. Ferguson (eds), *War in the tribal zone. Expanding states and indigenous warfare*, Santa Fe (NM).
- Goudriaan, K., 1988: *Ethnicity in Ptolemaic Egypt*, Amsterdam (Dutch monographs on ancient history and archaeology 5).
- Hall, J., 2002: *Hellenicity. Between ethnicity and culture*, Chicago/London.
- Hodder, I.R., 1982: *Symbols in action. Ethnoarchaeological studies of material culture*, Cambridge.
- Jones, S., 1997: *The archaeology of ethnicity. Constructing identities in the past and present*, London/New York.
- Roymans, N., 2004: *Ethnic identity and imperial power. The Batavians in the Early Roman empire*, Amsterdam (Amsterdam Archaeological Studies 10).
- Van Andringa, W., 2003: Cités et communautés d'expatriés installées dans l'empire romain. Le cas des *cives Romani consistentes*, in N. Belayche/S.J. Mimouni (eds), *Les communautés religieuses dans le monde gréco-romain. Essais de définition*, Turnhout, 49-60.
- Wenskus, R., 1977² (1961): *Stammesbildung und Verfassung. Das Werden der frühmittelalterlichen gentes*, Köln/Wien.

Ethnic expression on the Early Iron Age and early Archaic Greek mainland. Where should we be looking?

Catherine Morgan

- 1 Introduction
- 2 Mediterranean interconnections
- 3 Reading the expression of ethnic identity
- 4 Formulating a research design
- 5 Conclusion

Abbreviations

References

I INTRODUCTION

The construction and expression of individual and group identity has been one of the most extensively explored aspects of the history and archaeology of Early Iron Age and Archaic Greece in the past few years.¹ Particular attention has been directed towards ethnic identity, and especially the ways in which political communities and sub-groups drew upon the great ‘tribal’ identities of the Greek world (Dorian, Ionian, Achaian etc.) as part of the wider discourses through which social proximity or distance were articulated.² Considerable progress has also been made in understanding the more general role of ethnic claims of all kinds in the rhetoric of political association within and beyond the old Greek world, emphasising that in the open, interconnected Mediterranean prior to 480, the language of association was more powerful than that of exclusivity, let alone ethnic purity.³

Yet if there is broad consensus on the importance of ethnicity, the kind of situations in which it came into play, and its basic nature as a process of identity construction, there is less agreement about how the process and its outcomes should be traced and interpreted in the record. This is not wholly a reflection of different historical circumstances. This article focuses on the neglected area of research strategy with particular reference to the early Greek mainland. I have chosen this period and area partly because, by

¹ I am grateful to Ton Derks and Nico Roymans for their hospitality at a most stimulating round table discussion. I thank my fellow participants, Sofia Voutsakis and Thomas Heine Nielsen, for valuable discussion of issues raised. This article was prepared when my book, *Early Greek states beyond the polis* (published in 2003) was at press. Its aim was to emphasise key issues addressed in that book and to focus on methodology. Five years on, were I to write afresh under the same title the results would

be very different – both my own work and the field in general have moved in a variety of new directions. Yet there seems still to be merit in summarising the main issues addressed in *Early Greek states* and considering the rationale for the book. It is in this spirit that this chapter is presented with minimal updating.

² See, for example, Crielaard in this volume; Hall 1997.

³ Hall 1997, chapter 3; Horden/Purcell 2000, 396–400; Morgan 2003, 1–4.

contrast with other cases discussed in this volume, the limited and specific role of writing throws into particularly sharp relief the role of material objects as a means of communication. More particularly, however, changing views of state formation, a major framework around which ethnicity may operate, are of particular importance. In this context, the political dimension of ethnicity should be conceived both in terms of the process of making claims to a particular stake in a community and in the way in which particular forms of discourse may become the dominant mode of authority. Indeed, recognition that political communities defined primarily in ethnic or the polis/place terms were in practice tiered rather than mutually exclusive forms of association begs the question of the processes by which political salience came to be accorded to a particular set of associations in each local set of circumstances.

In this article, I follow Orlando Patterson's definition of ethnicity as, 'that condition wherein certain members of a society, in a given social context, choose to emphasise as their most meaningful basis of primary, extrafamilial identity certain assumed cultural, national or somatic traits.'⁴ Ethnicity is a continuing process of choice, manipulation and politicisation, highlighting traits accorded active importance (either by the group themselves or in response to outsider perceptions) in the structuring and expression of socio-political relations within the community and in relation to outsiders. The aim should therefore be to move beyond outcome to trace process, emphasising the strategy of definition according to context rather than on the precise criteria chosen (indeed, ethnically salient criteria are rarely objectively definable).⁵ While Patterson's approach has been criticised as instrumentalist, it seems inevitable that ethnic identity will be claimed or exploited to mask some other political and/or economic purpose. One should not be surprised to find that groups sometimes consciously or unconsciously obscure certain intentions to reach particular goals, or if unforeseen benefits or consequences resulted. More seriously, it is misleading to separate and privilege other explanations (economics or gender, for example), not least since ethnic discourse generally draws on whatever is seen (by insiders or outsiders) best to articulate the distinctive nature of the group concerned in the social context in which it operates. As this observation highlights, ethnic identities can arise both from insider perceptions and from the views of outsiders subsequently internalised. But especially under circumstances such as those of early Greece, where there was no overarching bureaucracy to provide classifications of groups distinct both from asserted ethnicities and localised political organisations (even though there are strong hints of the existence of such groups in a tantalisingly fragmentary epigraphical record), and where much depends on modern assessments of diverse source material, the question of 'cultural' as opposed to 'ethnic' identity is highly problematic. Since modern analytical perceptions are fundamental to the etic aspects of ethnic construction, we should at least be aware of the much-debated issue of the extent to which 'cultural identity' is a product of modern classification with no intrinsic explanatory power, leaving strong expressions in the record to be explained in other terms. We will return to these questions later.

2 MEDITERRANEAN INTERCONNECTIONS

It may seem strange to begin an article on the Greek mainland by focusing on the western colonial world. But this is done partly because innovative research in this area is directly relevant to my approach to the old Greek world, and partly because the extent and complexity of long-term interconnections make it hard to justify treating the two regions as fundamentally different. These connections beg assessment of the contexts and social registers in which various forms of relationship were expressed, and ethnicity thus created and enacted.

⁴ Patterson 1975, 308; cf. Barth 1970. For critique: Smith 1986, 9-10.

⁵ Morgan 2001b, 76-77; Morgan 2003, 10-11.

In Sicily and Magna Graecia new communities, more or less directly derived from one or (frequently) more differently constituted mother cities or ethnē scattered across the old Greek world,⁶ were forced to define and redefine themselves in relation to their Greek and native neighbours as well to as their mainland geographical, political and ethnic heritages.⁷ This process certainly exploited old Greek ‘tribal’ affiliations, which thus acquired new associations and meanings. Irad Malkin has emphasised the way in which the migratory nature of Sparta’s Dorian ‘charter myth’, centred on the return of the Herakleidai, served both as a paradigm and a rich source of imagery for her real or claimed colonising ventures in the varied circumstances of Sicily and South Italy, North Africa, the Peloponnese and the islands.⁸ Achaian identity is even more complex, encompassing as it did a range of evocative and variously emphasised epic, North Peloponnesian and Achaian colonial geographical associations which could be developed in different ways according to context.⁹ Affiliations of this kind were from time to time explicitly expressed via a wide variety of civic material statements, ranging from coin imagery¹⁰ to the development of particular cults. Indeed, despite long-standing scholarly emphasis on metropolitan origins, certain cults which achieved prominence in western cities drew on a range of ethnic, geographical and political associations wider than those offered by the mother city alone. In the case of Hera, for example, one should note in addition to local cults, her wider Peloponnesian role and the epic Achaian connections of the Argolid, home to one of her most renowned sanctuaries.¹¹ Equally, the myth charter of Metapontine Artemis owes less to metropolitan Achaia (where Artemis was worshipped from the mid-8th century onwards at Ano Mazaraki) than to Artemis’ place in epic tradition.¹² Bacchylides’ epinikian X (XI) for Alexidamos of Metapontion places the immediate origins of the cult in Azanian Lousoi, at a sanctuary established by Proteus during his successful endeavour to be reunited with his daughters, who had wandered for thirteen months through Arkadia after their flight from Argos to Tiryns.

Investigation of the material expression of ethnic identity has certainly not been confined to purely public contexts. Potential for the material expression of group identity has increasingly been recognised in diverse aspects of lifestyle – choice of food products, for example, and the manner of their preparation and presentation.¹³ Here one might cite the circulation of the distinctive indigenous Sicilian amphora types which probably held honey or the native drink hydromele, shape preferences in cooking vessels which relate closely to the manner of food preparation.¹⁴ Likewise, imported tablewares may, in addition to expressing wealth and status, affect behavioural matters like portion size, what is served communally or individually, or how provision is made for individual foods. Attic serving and drinking shapes in the context of Black Sea colonial domestic assemblages and local elite graves are such a case.¹⁵ Such forms of shared conduct contribute to perceptions of communal traditions just as much as the kinds of public monument and ritual (notably tomb cults) on which attention has often focused (see further below). But since both private and public manifestations of this kind can operate in a variety of social registers,

⁶ For a recent critique of state focused interpretations of early colonial settlement, stressing private enterprise, mixed groups, and the diversity of claims for settlement origins, see Osborne 1998, and compare the fuller archaeological picture presented by Yntema 2000.

⁷ For a review with bibliography, see Morgan 1999a.

⁸ Malkin 1994.

⁹ Morgan 2002; Giangliulo 1989, 161–171.

¹⁰ Parise 2002. One does not have to follow the wider economic arguments of Papadopoulos 2002 to appreciate the use of specific imagery.

¹¹ Giangliulo 1989, 174–181; Giangliulo 2002; Osanna 2002.

¹² Giangliulo 2002, 290–294. Achaian cults are reviewed by Osanna 1996; for Ano Mazaraki, Petropoulos 2002.

¹³ For a much later illustration of this point, see Joyner 1997.

¹⁴ Albanese Procelli 1996, esp. 125–126; Albanese Procelli 1997, 14–15; Antonaccio 2001, 130 and note 98.

¹⁵ Morgan 2004; Morgan forthcoming a.

from family to ethnos or polis,¹⁶ it is essential to understand both the specific local context and the wider patterns of behaviour within which it fits.

By contrast, the long-standing focus on typology, reading ethnic significance into the forms and styles of buildings and artefacts, has rightly come under critical scrutiny as the various interconnected aspects of the origin, reception and adaptation of particular forms and designs, the location and mode of production, the identity of producers and the nature and source of the materials used have been disentangled and reappraised.¹⁷ Radically different interpretations may result, as the case of the indigenous settlement at Morgantina in the eastern Sicilian interior well illustrates. Here a 6th-century phase of construction, in mud brick but featuring tiled roofs with architectural terracottas, succeeded (and in places overlapped chronologically with) 'indigenous' Early Iron Age longhouses.¹⁸ Together with the popularity of Greek imports, especially pottery, in contemporary graves and in the settlement on and around the Citadella acropolis, this change (characterised as 'urbanisation') was long taken as evidence of Greek settlement, with an accelerated process of 'Hellenisation' enhanced by contact with the Greek colony at Gela. Yet consideration of the individual contexts involved produces a more complex picture. The public buildings which featured so-called Greek-style roofs, and on occasion terracotta moulded frieze decoration, accommodated not only cults accessible to all elements of the population, but also in the case of the so-called Four Room Building, long-established local institutions (such as elite dining). In form, these buildings owe as much to other parts of Italy, Etruria in particular, as the Greek world. Equally, the burial record shows strong continuity in grave offerings and tomb types (favouring chamber tombs). Imported fine pottery reinforced established shape preferences (symposium equipment for use in communal dining for example), whereas cooking pots and vessels closely linked with food preparation remained predominantly local.¹⁹

As both Claire Lyons and Carla Antonaccio have emphasised, the limited nature of the behavioural changes implied by the use to which imports and local copies were put at Morgantina hardly implies a change in population. Rather, the site is typical of a number of inland indigenous centres in adopting a range of material goods (apparently an eclectic range, although that may be a hellenocentric perception) in a general context of elite aggrandisement. Imports formed part of a prestige goods economy whereby local chiefs exploited connections with a Greek colony such as Gela to acquire the material trappings with which they could enhance their own status. That they asserted control over trade in some way seems uncontroversial, although the exact mechanisms employed are harder to reconstruct. Equally, one might debate the extent of direct elite intervention in the production and distribution of the local commodities used in this exchange. At Morgantina, as elsewhere, there are clear links between wealth, status and a construction of identity which plays on both Greek and Sikel affiliations – in language for example,²⁰ as well as the kind of material statements noted above. Indeed, this interplay between ethnic claims and social status serves to reinforce my introductory remarks about the general unhelpfulness of over-precise classification of behaviours. The basic point is that a local hierarchy asserted its power by reference to its ability to exploit, and likely command and control, connections with the colonial world. Under such circumstances, it is hardly surprising to find that what has been seen as 'Hellenisation' (although might better be described as *bricolage*) and the beginnings of assertion of indigenous identities emerged at much the same time.²¹

¹⁶ The issue of the social register(s) in which Thessalian funerary cults operated is discussed by Morgan 2003, 192–195.

¹⁷ See, for example, papers in Crielaard/Stissi/Van Wijngaarden 1999. Papadopoulos 1997 raises important issues while focusing strongly on producer mobility.

¹⁸ Evidence and arguments are summarised by Antonaccio 1997; see also Leighton 1993, chapter 5.

¹⁹ Neils 1991; Lyons 1996 chapters 3, 8; summarised by Morgan 1999a, 97–114.

²⁰ Antonaccio/Neils 1995.

²¹ Albanese Procelli 1991; Lyons 1996, chapter 6; Antonaccio 2001, 127–133; Leighton 1999, chapter 6; Morgan 1999a, 97–115; Terrenato 1998 makes many analogous points on *bricolage*.

The innovative work done in many parts of Early Iron Age and Archaic Italy rests not only on recognition of the pragmatic and ideological issues surrounding the definition of personal and group status which flowed from the mixing and juxtaposition of populations, but also on critical historiographical approaches to the retrospective (and outsider) ethnographical narratives of Thucydides and Herodotus in particular.²² With the significant exception of Crete, the remainder of the Greek world has rarely been problematised in the same way. Yet connections between different parts of the Mediterranean operated on such a complex range of social, political and economic levels that it is hard not to see the different kinds of group identity, constructed on the basis of more or less shared social, political and economic referents, as part of a single spectrum. This is not to suggest that any wider Hellenic identity resulted from 8th-century colonisation. Whatever sense of Greekness emerged in the colonial west at this stage was neither strong enough nor construed so as to be useful back on the mainland: nor was it sufficiently distinct to serve as a mirror in which settlers could contemplate their shared identity.²³

Despite substantial evidence for the role of private (even anti-establishment) enterprise in early colonisation, in Robin Osborne's words, 'the model of a human colony remains tied up with states'.²⁴ It is not necessary to infer any direct transfer of political organisation between colony and mother-city to understand that early settlers in the west brought with them a diversity of experience in the construction and complexity of political identity, and the role of what have come to be seen as key elements of it (such as city life). Consideration of just two of the regions particularly prominent in 8th-century western colonisation, Corinth and Achaia, supports this point. By the time of colonisation, both had long been engaged in a complex network of interconnections along the Gulf, in the Ionian Islands and Italy (albeit in the case of Achaia not specifically with the areas later colonised). These connections certainly expanded and shifted in geographical focus during the 8th century, but they date back at least to Protogeometric times in the case of Corinthian links with Otranto, and for Achaia into the Late Bronze Age.²⁵ The extent of the material debt of the Achaian colonies to Peloponnesian Achaia and the wider Gulf milieu has convincingly been shown to be much greater than previously thought, with attention focusing both on the stylistic similarity of the earliest colonial pottery to that of the northern Peloponnese (which was already in circulation in various parts of the west), and on the variety of stylistic influences and connections evident in homeland Achaian production.²⁶

But if Corinth and Achaia were more or less equally engaged in international navigation and trade well before the establishment of settlements abroad, greater contrasts are evident in their domestic social

²² Antonaccio 2001; Morgan 1999a, 87–92, noting extensive previous bibliography. On the colonies within the later Bosphoran Kingdom, see Morgan 2004, chapter 3 (on tablewares); Morgan forthcoming a.

²³ Hall 2002, chapter 4; Hall 2003.

²⁴ Osborne 1998, 252.

²⁵ For a general review, see Morgan 2003, 213–222. Eder 2003 discusses Late Bronze Age connections; for Corinth: D'Andria 1995; Yntema 2000, 23–32, considers the evidence in the wider context of Salentine settlement development; Morgan 1998 on patterns of Corinthian contact, with full bibliography. Dehl 1984 remains a fundamental study of the distribution of 8th-century Corinthian fineware in Italy, although one should allow the likelihood of an admix of Ithakan and perhaps Corfiote Corinthianising among supposedly Corinthian imports.

²⁶ Coldstream 1998; Tomay 2002. Papadopoulos 2001 is both broader in scope and more questionable, since the catalogue (not always based on autopsy) conflates under the heading of Achaian or Achaianising stylistically similar vases of various dates locally produced in different parts of the Gulf and with clear local stylistic pedigrees (a point also emphasised by Tomay 2002, 350). The notion of a single style source for this pottery is in itself highly problematic, privileging as it does what we now choose to perceive as the most important centre(s) – a risky exercise especially at a time when archaeology in the north west in particular is producing a wealth of new evidence. The primacy which Papadopoulos accords to ('Magna') Achaia is reminiscent of older assessments of Corinth, and a retrograde step in evaluating the true complexity of interactions.

and political organisation, and thus in the experience of group affiliations and identity expression which colonists might carry with them. Of all Greek states constructed simply as poleis, Corinth saw perhaps the closest and most consistent association of a territory, a single dominant settlement centre, and identification with the regional ethnic. ‘Qorinthios’ is first attested as the name of the dedicator of a wooden votive plaque at Pitsa in the latter part of the 6th century, but it should probably also be read on a local plate from Megara Hyblaea around a century earlier.²⁷ Even though a number of important secondary settlements outside the city centre of Corinth were established or expanded markedly through the late Archaic and Classical period,²⁸ sub-regional ethnics remain rare. The earliest individual to describe himself in these terms, En[t]imidas Solygeatas, dedicated a bronze bowl to Poseidon at Isthmia at some point during the Archaic period, but we have to wait until the second half of the 4th century for the next secure instance (Agathon Kromnites).²⁹ In Achaia, the coastal zone has produced evidence of large settlements (such as Aigion)³⁰ which, even allowing for problems of preservation and the limitations of rescue archaeology, appear similar to contemporary centres within poleis. In many respects, a settler from this area would carry with him much the same practical experience of ‘city life’ as a contemporary Corinthian. Taking Achaia as a whole, however, very different local trajectories in the *mesogeia*, the north coast, the area of Patras, and Dyme, contribute to a much more complex regional picture.³¹ But while this might lead us to expect that local affiliations would predominate, colonial identity was in fact constructed in the regional ethnic register, even though there is scant evidence to suggest that this was politically salient in any other context at this time (when only the frontier with Arkadian Azania was strongly marked). Indeed, sources linking specific sites in mainland Achaia with colonial myth-histories tend to be late and inconsistent.³² Various (mutually compatible) explanations may be advanced. Mixed groups of colonists might have found common ground only at this level, epic connotations may have been attractive from the start, or in a context of intensive maritime activity, Achaia could already have come to serve as a general shorthand description, perhaps initiated by outsiders, for this part of the north Peloponnesian coast.

Clearly, the experiences brought by Achaians and Corinthians to their new colonial foundations must be set within a longer and more complex history of interactions between Italian and old Greek communities. While this is often considered in terms of commodity exchange and movement of people, it is also important to consider the frameworks of (usually elite) shared behaviour which arose through the 8th century, and fostered traits such as the adaptation of imagery, affectation of foreign dress, ritualised friendship, or the use of overseas contexts to heighten established behaviour patterns.³³ A good illustration of this can be found in the 8th-/early 7th-century votive deposit at the sanctuary at Aetos on Ithaca, located in the middle of what appears to be an elite residential area, beside an important longhouse. Portable dedications, which are mostly either personal ornaments or small bronzes, reflect connections and ideas about status display drawn from a wide arc of contacts, from southern Italy through Macedonia,

²⁷ Wachter 2001, 156–157, COP App1Ad (Pitsa), 200–201, DOC 3 (Megara Hyblaea, c. 625–600).

²⁸ E.g. by modern Perachora, Kromna, and the large sherd scatter present on Rachi Boska: Wiseman 1976, 36, 66–70; Tartaron et al. 2006, 494–513.

²⁹ Raubitschek 1998, cat.48; Wiseman 1976, 10. The one possible instance in the intervening period, an inscription naming Timos Teneos on the lip of an Attic black-figure band cup of ca. 540–530 from Sellada on Thera, could be a genitive patronymic, and the identification of the script as Corinthian is controversial: *To Έργον της Αρχαιολογικής Έταιρείας* 1961, 209, fig. 224; Wiseman 1976, 14, note 8.

³⁰ Papakosta 1991, 236–237.

³¹ Morgan/Hall 1996, 166–199. Compare, for example, Morgan 2003, 55–61 and Papakosta 1991, 236–237.

³² Morgan/Hall 1996, 199–213; Morgan 2002; Morgan 2003, 176–187.

³³ Malkin 2002 offers analogous reflections. This phenomenon has been most fully evaluated in the context of later Archaic and Classical Athens: see among extensive literature Cohen 2001 on dress; Miller 1991, chapter 7 on dress and personal ornament, noting also her more general discussion of reception in chapter 10.

central Greece and the Peloponnese, and out to Crete and Cyprus. Ithacan figurative iconography, found almost exclusively at this sanctuary, includes a unique body of highly ritualised imagery on vessels likely used in cult activities. This incorporates traits from a range of Italian, mainland Greek (Corinthian, Attic and Euboian) and Near Eastern sources, and include depictions of chariots, side-saddle male riders, and long robes worn by male participants in ritual events – all traits which could themselves be deployed in the expression of a variety of personal identities – involving a complex of social connotations which may or may not have been transferred with the image.³⁴ Ritualised friendship was not an exclusively Greek institution: it merely required that the partners involved were of equal status, and early instances involve non-Greeks with great frequency.³⁵ It is therefore interesting to speculate about the origin of the ‘guest-friend, personal friend, and faithful companion’ greeted in an inscription of c. 700 (the earliest so far attested in Achaean script) on a long-necked conical oinochoe from Aetos.³⁶

The appearance of non-Greek objects in Greek ritual contexts has frequently given rise to debate about the identity of their dedicators and the rationale for their deposition. Lavish Italian, and especially Sicilian, metal dedication at Olympia from the late 9th- (and especially the mid-8th) century onwards is such a case, and one of particular interest given the later history of Italian dedication (notably of treasuries) and, especially in the case of Sicily, often highly successful participation in the Olympic games.³⁷ Explanations range from offerings by elite Italian voyagers to dedications by colonial Greeks at a prestigious old world sanctuary which lay conveniently outside the territory of their motherlands, or the gifts of Greek traders or pirates (noting the high proportion of weapons involved). Weapons could be practically connected with the violence often associated with colonialism, yet their display, as that of metal resources in general, was of growing importance to the expression of elite (‘princely’) male status in burials in several parts of Italy, especially the broader Tyrrhenian region encompassing the Bay of Naples, Campania and Latium, from the late 8th century onwards, coincident with the greatest volume of dedications at Olympia.³⁸ In other words, this is exactly how one would expect an Italian aristocrat to express his status should he choose to do so in the heightened context of an overseas sanctuary (and the importance of the *agon* at Olympia in particular is crucial). These explanations are not mutually exclusive, and it is likely that Olympia was an institution meaningful in different ways within a range of different social and political systems.

Bridge-building behaviours and mechanisms of this kind, while prominent in the colonial world, are hardly confined to it, and instances elsewhere in Greece should be seen as part of a continuum. They often draw upon ethnic language and connections. Thus, for example, *xenos*-derived names include regional ethnics,³⁹ here too used at a time when they are unlikely to have had more than a limited state-political salience. Peisistratos’ choice of the name Thessalos for his son⁴⁰ reflects a focus on the regional level of identity (via Thessaly’s eponymous hero) presumably shared by those with whom he had close ties of friendship, and it is tempting to suggest that the same was true of Ptoiodoros of Corinth, whose son Thessalos won the Olympic *diaulos* in 504.⁴¹

³⁴ Morgan 2001a (noting that the single exception is a kantharos exported to Pithekoussai, and that no such evidence has been found elsewhere on Ithaca); Morgan 2006. The wider cult and material connections of the sanctuary at Aetos are fully assessed by Symeonoglou 2002; Morgan forthcoming b.

³⁵ Herman 1987, 10–13 (see also appendix A).

³⁶ Robertson 1948, 80–82; Wachter 2001, 168–169, ITH 1: ξένος τε φίλος και πιστός έταίρος.

³⁷ Evidence is summarised and analysed by Philipp 1992, 36–44 and Philip 1994, 82–85; Shepherd 1995, 73–76;

Antonaccio 2001, 133–135; Antonaccio 2007.

³⁸ Cinquantaquattro 2001, 123–130; d’Agostino 1999; *Principi*, see esp. 225–227 with associated catalogue references.

The extent to which this escalation reflects local entry into wider aristocratic value-schemes centred on honour and valour is well discussed by Crielaard 2000.

³⁹ The phenomenon is discussed in the wider context of *xenia* and naming by Herman 1987, 19–22.

⁴⁰ Thucydides 1.20.2, 6.55.1.

⁴¹ Pindar, *Ol.* 13.35.

How, then, may we approach issues of this kind in the specific circumstances of the early Greek mainland? Problems surrounding the material and historical analysis of ethnic identity as constructed and expressed on a supra-state level are considered in Jan Paul Crielaard's discussion of the Panionion in this volume. Rich and important as this level of analysis is, especially when it also gives a place to some of the comparatively poorly understood associations that self-consciously constituted themselves in such terms, it is not the focus of this present paper. In recent years, a number of studies have been devoted to ethnē – to those states primarily defined, at least by the 5th century, in terms of a regional, rather than the city (polis), identity. These cover a wide spectrum of development, ranging from that of Phokis, where the 6th-century emergence of a *koinon* followed the violent end of the Thessalian occupation,⁴² to Arkadia, where the politicisation of the regional ethnic proceeded slowly and in parallel with that of city and sub-regional ('tribal') ethnics,⁴³ or Triphylia, created wholly anew from an early 4th-century association of local poleis,⁴⁴ and the elusive Archaic Azanes of northern Arkadia.⁴⁵ These studies focus on more local salience, with the aim of tracing the circumstances (place, location and actors) under which an ethnic (usually regional) was deployed with active political intent. As is plain from this now extensive body of work, on a variety of levels beneath that of the great panhellenic 'tribal' identities, ethnic expression was crucial to the construction and subsequent definition and redefinition of the various identities to which an individual might subscribe under different circumstances.

At the heart of the discussion, therefore, is the issue of when and how social groups opened and closed, with particular kinds of identity created and deployed, and how this changed over time. Reconstructing the contexts which frame and determine the form of such behaviour is a substantially (although far from exclusively) archaeological issue, but it demands a more sophisticated approach to the material record than has often been adopted. Drawing on the work of Bourdieu and Bentley, Siân Jones has emphasised the need to explore more fully the relationship between ethnicity and culture. Rather than resorting to the uninformative notion of cultural identity, she sees ethnic expression grounded in what, to use Bourdieu's term, may be called the *habitus* (i.e. the 'principles of generation and structuring of practices and representations which can be objectively 'regulated' and 'regular' without in any way being the product of rules').⁴⁶ Intersubjectivity is crucial here; the *habitus* does not merely define the contexts of ethnic expression and provide the pool of signifiers on which it draws, but shapes and is shaped by the form and effects of that expression.⁴⁷ But before considering the archaeological implications of these propositions, it is worth pausing to assess how they compare with recent approaches to the process of defining ethnic identity in the early Greek world.

Social science literature reveals a considerable diversity of approaches to the definition of ethnicity, and especially to the range of personal or group identities to which the term may be applied (or with which ethnicity may be from time to time become so entwined as to make them an integral part of a specific investigation).⁴⁸ This is echoed in recent work on early Greek ethnicity which raises various issues of considerable importance to the formulation of the kind of research designs discussed in this article. Perhaps the strongest recent advocate of a very restricted definition, Jonathan Hall, follows Max Weber in defining ethnicity strictly in terms of kinship (accepting that this may be fictive, and including also consubstantiality). Hall's objection to polythetic definitions rests on what he sees as the limited heuristic potential of a concept defined by different means in different situations. To be useful in any comparative

⁴² McNerney 1999, chapter 7.

2003, 176–186.

⁴³ Heine Nielsen 2002, esp. chapters 2–4.

⁴⁶ Bourdieu 1977, 72.

⁴⁴ Heine Nielsen 1997.

⁴⁷ Jones 1997, 87–100.

⁴⁵ Petropoulos 1985; Heine Nielsen/Roy 1998; Morgan

⁴⁸ Jones 1997, 56–83.

analysis, ethnicity must have a universal fundamental meaning. The social context in which it operates may vary, but the definition of the concept will not.⁴⁹ One might reasonably doubt whether the impact of variation in social context upon ethnic expression would have been so slight as to make a monothetic definition of ethnicity automatically an effective (let alone the best) entrée to identification and analysis in all cases. If, as Frederick Barth argues, ‘ethnic categories provide an organizational vessel that may be given varying amounts and forms of content in different socio-cultural systems’,⁵⁰ is the existence of an ethnic category more important than its content? A monothetic definition certainly facilitates broad, (often) cross-cultural comparisons as Hall rightly emphasises. And indeed, the existence of a number of common frames of reference (the pantheon,⁵¹ for example, or the swift spread of a common alphabet)⁵² in the otherwise highly diverse Archaic Greek world is itself striking. But as the local variations, accretions of meaning and patterns of deployment traceable in each case highlight, it is a significant step to infer conceptual centrality and uniformity of meaning of a criterion such as kinship simply from its ubiquity, especially as non-Greek peoples were included within the same frame of reference. In short, even if one broadly accepts Hall’s observations about the primacy of kinship, it remains only a part of the story. If ethnic identity is to have any historical import, the entire context of action must be reconstructed – in any case an essential step to a ‘thicker’ understanding of the rhetoric of kinship in each case.

Preference for a monothetic definition of ethnicity also has significant implications for our contemporary engagement with the ancient record in all its forms. It is undoubtedly true that Archaic Greeks used the language of kinship widely to describe a variety of key associations and relationships. But we are hardly bound to limit ourselves to accepting their conceptualisations at face value – that would be to risk self-fulfilling argument. The result may not be ‘wrong’, but it will be partial at best, and more importantly, deliberately or not, it downplays the critical input of the modern analyst. There are obvious (if usually unavoidable) risks in defining the generally recognised, empirical criteria required if we reject the relativist position of treating equally a plurality of perspectives on the past, and seek to evaluate competing interpretations. Especially in a field like ethnicity, the extent to which such judgements implicate scholars as arbitrators in contemporary political debate should not be underrated.⁵³ In practice, most commentators are only too well aware of the implications of the extremes of empiricism and relativism, not least because both in their different ways limit personal responsibility. Either sound argument using correctly identified criteria must produce ‘correct’ results, making different interpretations automatically less valued, or the analyst’s standpoint is so fully integrated into the argument that different views cannot be independently evaluated. Most seek some kind of middle ground, accepting to varying degrees the existence of, and need to document plurality, with all that that implies for innovation in research design, but recognising the importance of critical evaluation. How this may be achieved is, of course, a much debated matter which could fill more than one further chapter. None of this negates Hall’s argument, nor is it intended to do so. But from a historiographical point of view, it is important to locate one’s chosen approach within the empirical-relativist spectrum and to recognise its consequences.

One important consequence of treating kinship as the sole criterion defining ethnicity is the specific nature of the media (i.e. written sources) from which it can be read directly. As Hall puts it, ‘ethnicity can be communicated archaeologically, but there can be no archaeology of ethnicity among societies who have left us no record.’⁵⁴ At first sight, this conclusion casts into doubt the possibility of investigating an

⁴⁹ Hall 2002, 11-12.

⁵⁰ Introduction to Barth 1969, 14 (F. Barth).

⁵¹ Schachter 2000; Polignac 1998.

⁵² See e.g. Johnston 1999.

⁵³ Jones 1997, 10-12, 61-62. Childe 1933 illustrates the severity of such concerns in the past. It is worth recalling

the formative role of Classical scholarship in anthropological analysis of kin-based social and political systems from the 19th century onwards: see e.g. Morgan 2003, 12-16, for a summary of approaches to tribalism with bibliography.

⁵⁴ Hall 2002, 24.

important social phenomenon (to judge from the very diverse usage of the word *ethnos* and its cognates in pre-Classical written sources)⁵⁵ before the adoption of alphabetic writing in the 8th century. It also risks sidelining the behaviour of a significant sector of the population who did not have access to (let alone control of) the genealogical discourse reported in written sources, or the skills and means of writing.⁵⁶ It is not simply that relatively little contemporary written evidence survives. Early writing is a distinctive kind of artefact deployed for particular purposes, and only occasionally on the stone and pottery which survive archaeologically. It represents one register of communication, and we have only hints of the oral context within which it developed and functioned⁵⁷ (for example in the construction of personal names, where the occasional use of regional ethnics has already been noted,⁵⁸ or the oral histories which informed the great narrative syntheses of the 5th and 4th centuries).⁵⁹ Graffiti in particular continue to be discovered, and it is certainly true that close examination of certain types of medium (notably rock outcrops in pasturelands) is now proving fruitful. But whether such evidence will radically change our current understanding remains debatable. Clearly, though, the overall pattern of deployment of written language in Archaic Greece is so different from the Hellenistic and Roman evidence discussed elsewhere in this volume, that unless major areas of early response to thought about identity are to remain an intellectual void, research designs must be shaped accordingly.

Hall's observation does, however, reveal a perception of archaeological analysis which should give pause for thought within the discipline. I have considerable sympathy for the implicit criticism of programmatic 'archaeologies' which is echoed in Nicholas Purcell's review of *The archaeology of Greek colonisation* that 'the heavier the load of cultural ideology in the phenomenon, the stranger it sounds to have an archaeology of it'. As Purcell continues, this is 'not to doubt, of course, that there is a material record relating to the contexts of ... political manifestations, or that one could quite legitimately set out to investigate the ties and dissonances between the material record and the cultural history of politics in such a case. One would, however, expect to identify the delicacy of such a task in a programmatic statement of considerable sensitivity'.⁶⁰ Without wishing to be unduly dismissive, many discussions of ethnicity in the old Greek world have tended to be rather narrowly channeled – even more so than in Ionia, the west, and in a somewhat different way, the Black Sea. By this I mean that they have generally emphasised the interaction of written and material evidence, with less attention paid to the more fundamental questions of the intellectual construction of the archaeological 'record' and the implications of shifts in our understanding of the socio-political construction of early Greek communities for the investigation of ethnic expression.⁶¹

It is now generally accepted that a straightforwardly typological approach to reading ethnic expression in material data does not work. Indeed, it is unfortunate that so much time has had to be devoted to setting out what was wrong with past 'ethnic' readings of the Greek record, rejecting the idea of fixed

⁵⁵ Smith 1986, 21; Hall 1997, 34–35; Morgan 2003, 9–10.

⁵⁶ A point made strongly by Antonaccio 2001, 115–116.

⁵⁷ For a full summary of the arguments, see Thomas 1992, 56–73.

⁵⁸ The fact that ethnically based names are relatively rare raises the question of the circumstances of their use: Morgan 2003, 207–211. In the early Archaic period, before the accrual of any substantial prosopographical record, script remains the more common means of detecting the presence of foreigners. A case in point is the relatively large collection of late 8th- and 7th-century graffiti on local pots (and thus presumably written *in*

situ) from Kommos on Crete: Csapo/Johnston/Geagan 2000, cat.nos 11 (Euboian, dedicatory?), 17 (probably Attic rather than Euboian or Cycladic, owner's mark), 19 (probably Boiotian, cf. Thessaly, Phokis or less likely Euboia, owner's mark), 27 (probably Lokrian, Phokian or northern Boiotian, owner's mark). See Csapo 1991 and 1993 for an overview.

⁵⁹ Lasserre 1976.

⁶⁰ Purcell 1997, 500.

⁶¹ The chief exceptions to the latter cluster in the colonial west: see e.g. Antonaccio 2001; Van Dommelen 2002; Yntema 2000.

cultural-material indicia to identify ethnic groups,⁶² since ultimately this adds little to the much broader debate about the nature, contemporary political exploitation, and analytical utility of archaeological ‘cultures’.⁶³ This is not to suggest that the act of classifying artefacts and mapping the distributions which form the palimpsests which we rationalise as cultures does not raise important questions about the behaviours underlying these patterns (i.e. the *habitus*). How do the various different territories of action add up to the political territory of a community (be it one which defined itself primarily as a polis or an ethnos)?⁶⁴ And while it is tempting to focus on areas of confluence, where are the dissonances in each case? To cite but one example, the regional distinctions in fine pottery styles which were particularly evident in southern Greece during the 8th century have often been seen, implicitly or explicitly, as having political significance.⁶⁵ This is certainly not an uncritical perception, nor is it generally construed in terms of individual state formation, as the correspondence between style and state political territories varies considerably, as does the extent of internal stylistic variation within regional schools. Such style groups could as well cover a single polis (as Corinth) as a region with several poleis (the Argolid) or a much wider area, like the western mainland (which thus came to be termed a *koine*). But political explanations must surely be underpinned by an understanding of attitudes to style and how these played out in context, as well the practical processes surrounding the creation and distribution of these vessels. How were particular shapes and types of decoration deployed in context, how did markets operate, and did producers specialise, have equal access to markets (a question also applicable to consumers), share facilities like kilns, or travel around?⁶⁶

A further major area of concern is how we conceive the political frameworks which form particularly potent contexts for the development and expression of ideas about ethnic identity (although they are far from the only such contexts).⁶⁷ Put crudely, we form the picture of ethnicity which best fits our understanding of political organisation – and here the fundamental differences between the various Roman and Greek situations discussed in this book cannot be too strongly emphasised. Through much of the 19th and 20th centuries, scholarly interest focused on the autonomous polis as the *telos* of Greek state formation, and conceptions of ethnicity closely tied to the modern nation state suited this well. Hence the popularity of work such as that of Anthony Smith, which is deeply entwined with a modern nationalist agenda.⁶⁸ Smith’s six criteria for the identification of an ethnic group (a collective name, shared history, common myth of descent, distinctive shared culture, association with a specific territory, and a sense of communal solidarity) echo the terms in which Anthony Snodgrass sought to trace the emergence of the polis from the 8th century onwards.⁶⁹ Both isolate politicised social entities, but neither explore their precise nature in any given case. Such approaches do not cope well with nested political structures⁷⁰ or with the phenomenon of transitory ethnicities and the loss of political salience: the implication of progress to nationhood should also be treated with great caution. Under certain circumstances, they may have heuristic value. Thus, for example, the Copenhagen Polis Centre’s collective study of Arkadia⁷¹

⁶² Most fully by Hall 1997, chapter 5.

⁶³ Among numerous such discussions, see e.g.: Jones 1997, chapter 2; McNairn 1980, 46–73; Shennan 1989; Veit 1989; and with particular relevance to the present discussion, Antonaccio 2003.

⁶⁴ See Morgan 2003, chapter 4 for a fuller summary of this discussion, with bibliography, in relation to the Early Iron Age and Archaic Greek mainland.

⁶⁵ See e.g. Coldstream 1983; Snodgrass 1999.

⁶⁶ Approaches are reviewed in Morgan 2003, 165–167.

⁶⁷ For analogous reflections focused on approaches to the

polis, see Davies 1997.

⁶⁸ Smith 1986.

⁶⁹ Smith 1986, 22–32; Snodgrass 1980, especially chapters 1–3; see also Snodgrass 1993.

⁷⁰ Smith 1986, 84 does distinguish between ethnic identity, sub-ethnic identity and more localised loyalties, but this disguises the conceptual similarity implied by the Greek use of ethnos for groups constituted at all levels of integration.

⁷¹ Heine Nielsen/Roy 1999.

opens with Thomas Heine Nielsen's application of Smith's criteria to determine whether the Classical Arkadians could constitute an ethnic group.⁷² Subsequent contributors then proceeded to investigate the processes by which Arkadian identity evolved, when and how it was expressed, and how the overall ethnic affiliation compared with other forms of local, sub-regional and regional identity (settlements, cult communities, or networks of relations facilitating various subsistence and trading activities) over time.⁷³ The book did not depend on Heine Nielsen's conclusions, but the basic exercise was valuable. But in many other regions, the full implications of the problems raised by identification of the existence of ethnic groups, both in terms of the reading of archaeological evidence and our changing understanding of the structure of early Greek political communities, have yet to be explored.

Following from this polis-centred perspective, one approach to finding the material assertions of distinctiveness which may betoken ethnic expression involves establishing dominant group identity, perhaps the composition of the population, and the ground rules of social behaviour to which a 'citizen' would normally subscribe according to age, gender and status, and then looking for breaks in these rules.⁷⁴ We seek regularities in the record which are interpreted as representing the norms of conduct by which citizens of a political community organise their lives – burying their dead, organising their cults and rituals, obtaining and use tools and utensils, or arranging their settlements. Deviance is assessed against this normative background, and these norms also enable us to evaluate the potential raw materials to which special cultural-political significance may be assigned as and when groups chose to assert an ethnic identity. This approach has indeed highlighted interesting situations. For example, Nicolas Coldstream, in comparing the nature and context of imported Attic pottery at Knossos and Lefkandi, showed how Knossians used imports to enhance established dining and funerary practices, whilst at Lefkandi, their appearance within distinctive and unusual burials following Athenian custom establishes a much stronger case for an assertively marked Athenian presence.⁷⁵ In theoretical terms, however, this does not take us much beyond the historical-behaviourism of Gordon Childe,⁷⁶ even if we tend to pay greater attention to the archaeology of 'deviance' (for want of a better term). In part this reflects the growing battery of scientific data that bring hitherto less accessible topics, such as attitudes to disease, disability and treatment of the body, within our purview. Hence work on subjects as diverse as attitudes to epilepsy in 9th-century Athens,⁷⁷ or post-mortem treatment of the body.⁷⁸ Yet such advances as have been made in these areas stem more from changes in the case material that can now be handled than from any increase in theoretical sophistication.

The same could be said of approaches to new kinds of site and context. The 8th-century settlement at Pithekoussai is such a case. Initially, it fostered considerable debate about its proper description within long-established categories (Phoenician or Euboian, colony or trading post).⁷⁹ Only later did it prompt re-evaluation of such issues as attitudes to artefact style and the use and the role of imports which has had a considerable impact in other parts of the Greek world too (the presence and significance of imports in reconstructing putative pre-8th century Euboian settlement in Macedonia, for example).⁸⁰ But the opposition between normal conduct and deviance upon which most such reconstructions rest is one-dimensional, and implies a degree of coherence and relative stability which is not always evident. Where circumstances are more complex, it does little to tease out the diverse ways in which the material record can reflect ethnicity. These objections do not apply to the concept of the *habitus* outlined above.

⁷² Heine Nielsen 1999, 18–46 (restated in Heine Nielsen 2002, 48–88).

⁷³ See, for example, Voyatzis 1999; Forsén/Forsén/Østby 1999; Jost 1999; Roy 1999; Morgan 1999c.

⁷⁴ As explored in Morgan 2001b, esp. 84–92.

⁷⁵ Coldstream 1996.

⁷⁶ McNairn 1980, 70–73.

⁷⁷ Little/Papadopoulos 1998.

⁷⁸ Evidence from Elateia, studied by Profs. E and S. Reuer, will be of considerable interest in this respect.

⁷⁹ Ridgway 1992, 108–111, offers a valuable review; see papers in d'Agostino/Ridgway 1994, and more recently Ridgway 2000, 183–186, addressing subsequent debate.

⁸⁰ Contrast Snodgrass 1994 and Papadopoulos 1996.

The problem of assumed coherence leads us back to the issues raised earlier in this article, and to consideration of the implications of more recent research into the nature of, and relationship between, poleis and ethne in early Greece. The programme of the Copenhagen Polis Centre (CPC), while much debated, has resulted in two solidly documented conclusions of particular significance for the present discussion. First, communities which called themselves poleis were not always the autonomous, politically independent entities commonly assumed on the nation-state model.⁸¹ They frequently existed within ethne and in dependent relationships to each other (as is clear in many regions from Lakonia to Crete).⁸² As I put it in 2003,⁸³ ‘far from being distinct and alternative forms of state, poleis and ethne (operative at regional, supra-regional or sub-regional level, as exemplified by the Arkadian ‘tribes’)⁸⁴ were thus nested tiers of identity with which groups could identify with varying enthusiasm and motivation at different times’. I further commented on the way in which individuals’ social identities consisted of a palimpsest of inherited and ascribed traits which were more or less important under different circumstances, and the political identity of individual communities was constructed from a complex of associations, including relationship to a polis, an ethnos or variously constituted groups within these, which could be differently weighted to the perceived advantage of that community. In *Early Greek states* I also explored other forms of (often extra-community) class or interest bond, such as ties of *xenia* or cult communities (certain of which date back in one form or another to the Late Bronze Age–Early Iron Age transition, usually undergoing complex changes of constituency and/or interest representation over time, as illustrated in the case of Kalapodi in Phokis).⁸⁵ With hindsight, I could have paid greater attention to the existence of further forms of association implied by the quite substantial number of epigraphical attestations, even though we generally know little or nothing specific about them other than their name.⁸⁶

The second conclusion from the work of the CPC concerns the correlates of polis status, notably the use of the city ethnic⁸⁷ and a strong association with a dominant settlement centre, which seem to have been in place by the end of the Archaic period at the latest. The term polis was applied to settlements that were also central to a polis as a political community – and it is hard to find secure examples of poleis that lacked such a physical centre.⁸⁸ But it is less clear whether (and how) we can read back into the Early Iron Age the political role (whatever its precise form) of settlements which appear prominent within regional patterns, let alone whether the term polis should be applied (bearing in mind its great antiquity and likely original meaning as an acropolis or stronghold).⁸⁹ In practice, status tends to be judged on the basis of site size,⁹⁰ as while we have a growing body of detailed information on function obtained from large-scale open area excavations like those of the Athenian Agora and Kerameikos, it remains the case that most early big sites are reconstructed to a greater or lesser extent either from rescue excavations (as at Argos, Aigion, Megara or Sparta) or surface remains located via survey. Indeed, most site hierarchies proposed on the basis of survey data rest primarily on surface area, even though the thresholds involved are rarely explicitly defined.⁹¹ But whatever the precise circumstances of each site, the issue of attaching

⁸¹ Hansen 1995a; Hansen 1998, 78–83.

⁸² Hansen 1997b. See e.g. Shipley 1997; Perlman 1996.

⁸³ Morgan 2003, 1.

⁸⁴ For contrasting views, see Heine Nielsen 1996; Roy 1996.

⁸⁵ Summarised in Morgan 1999d, chapter III.1.

⁸⁶ One might, for example, speculate about the nature and function of the ‘chosen’ Thebans mentioned in the inscription Effenterre/Ruzé 1994, no.70.

⁸⁷ Hansen 1996a; Hansen 2004.

⁸⁸ Hansen 1996b; Hansen 1997a; Hansen 2000.

⁸⁹ Hansen 1996b, 34–36.

⁹⁰ Morgan/Coulton 1996, 91–99.

⁹¹ See Morgan/Coulton 1997, 120–129 for a review of these issues with bibliography on individual cases. A rare explicit statement of size categories used to reconstruct a local hierarchy is made in the final publication of the Southern Argolid Survey: Jameson/Runnels/Van Andel 1994, see especially table 4.5.

political significance to big sites raises a wide range of questions, from the specific functions fulfilled by nucleated settlements to more general issues of the impact of proximal residence through the Early Iron Age. One important consequence of accepting tiered political identity is the final abandonment of the much criticised social evolutionary models which had the ethnos as the primitive precursor of the polis.⁹² But a concomitant of this proposition is reappraisal of the supposedly ‘advanced’ developments in city centres by which polis formation is sometimes gauged (town planning, for example, although one might reasonably doubt whether there is any such thing as an ‘unplanned’ settlement), recognising that, with its connotations of social health and progress, the notion of ‘urbanism’ (itself a neologism)⁹³ may create anachronistic expectations.⁹⁴ Indeed, it is important to emphasise that by the 8th century there are striking similarities in the appearance of big sites across the polis-ethnos spectrum as traditionally conceived; compare, for example, Argos with Pherai in Thessaly.⁹⁵ If identification with a settlement centre was one point of articulation for personal or group identity, even if only in the sense of the place of primary residence, what other registers were there and how in practice did they differ? What issues arose from ‘city life’ in terms of the sociology of residence patterns, the maintenance of facilities and access to resources, how do these promote particular forms of identification, and what was conducted elsewhere (physically or in terms of supra-residential association) which could form a focus of identity that under the right circumstances might enter into ethnic discourse?⁹⁶

The Copenhagen programme raised important issues of the multiple registers in which the *habitus* was constructed in many areas of Greece, and thus the extent to which reading of ethnic claims must move beyond finding ‘breakage’ of ‘communal’ rules. This was the impetus behind *Early Greek states beyond the polis*,⁹⁷ and the reason for structuring it as a series of explorations of the main forms of association with which adult males in the Early Iron Age were likely to be involved. I will not here repeat discussion of the case material in the book, but will rather concentrate upon the questions asked. Perhaps because discussions of ethnicity in the ancient world have tended to be textually driven (and it is surely no accident that more work has been done on text-rich later periods, especially state or imperial organisations with extensive bureaucracies), attention has focused less on ethnicity as the process of situational identity creation and negotiation (with all that this implies for understanding of specific context), and more on the outcomes of that process. Beginning from documents containing ethnic statements, one works to explore the situations to which they pertain as examples of ‘ethnicity in action’. The results can be weak in explanatory power, relying rather on contingent circumstances and the notion of *mentalité*. Partly in response to the circumstances of the Peloponnese and central Greece which have rich, understudied and often recently discovered early records, and partly through dissatisfaction with limited theoretical perspectives, I instead chose to work from the premise that ethnicity is a process of identity negotiation – the act of dialogue or argument whereby groups are seen to stake claims to social power usually via politicisation of a particular kind of identity. Since, as emphasised, an effective ethnic claim will draw on whatever is seen (by insiders or outsiders) best to articulate the distinctive and different nature of a particular group in the context in question, this approach avoids the pitfall of compartmentalising status and purpose. Part of the problem of trying to find clearly defined cases of ethnic expression lies with the desire for clarity and exclusivity. That is, if a phenomenon can be otherwise explained, this should take precedence over ethnicity. This is not to suggest that everything be conflated under one vague heading, merely that label-

⁹² Exemplified by Ehrenberg 1969, 9–14.

⁹³ Cerdá 1868–1871; Morgan 2003, 19.

⁹⁴ As shown by Morris 1991.

⁹⁵ Argos: Aupert 1982 (see Morgan 2003, 62–64, fig.2.10 for more recent work). Pherai: for a summary, see Morgan 2003, 92–95.

⁹⁶ For extensive examination of these issues in relation to mainland Greece, see Morgan 2000; Morgan 2003, chapter 2.

⁹⁷ Morgan 2003.

ling is not an end in itself, and as I have emphasised, the kind of politicised situations with which we are concerned should make us wary of empty terms such as ‘cultural identity’.⁹⁸ We cannot fully understand ethnicity as a means of exercising or claiming power (in the widest sense of rights of some kind or access to particular socio-political discourses) without understanding the framework within which each claim is made, recognising that many early Greek communities themselves contained formally defined, usually subordinate groups (the Thessalian *penestai*, for example).⁹⁹ In other words, trying to trace the rationale for, and form of, a particular ethnic claim forces us to re-examine past assumptions about the complex of relations from which individual communities were constituted.

Reconstructing the chronological development of, and balance between, often highly localised ties of place and broader notions of people and/or geography in the construction of political identities is a particularly important challenge. One obvious question is which level of political integration came first in any particular region. Here the literary and epigraphical record offers little help, as both regional and city ethnics are quite rare before the late 6th century, and it is hard to trace any reliable chronological pattern in their use.¹⁰⁰ The main exception, Homer, and especially the *Catalogue of Ships* in *Iliad* 2 with its exceptionally wide geographical coverage, would seem to offer strong evidence for regional ethnic consciousness.¹⁰¹ The date of Homer (let alone whether the *Catalogue* was created for the *Iliad*) is of course much debated, and one might also protest that the simple use of ethnic plurals is not evidence for their political significance. But the *Catalogue* is a muster list, and the way in which contingents are presented reflects opinions (of whom we cannot tell) of what is appropriate in such a context. Within individual regions, however, there is no evidence to prioritise ethnic over place identities. Indeed, with the exception of the Parrhasians, Arkadian contingents are presented exclusively in terms of toponyms. The Arkadian case is unusual, though, and in general regional entries variously combine specific toponyms, wider locations of residence, and regional and sub-regional ethnics, resulting in an overall picture which, as I put it in the case of Thessaly, ‘frames in an highly abbreviated fashion what was probably a dynamic situation in terms of interlocking tiers of political affiliation and identity’.¹⁰² Homer aside, most of the earliest attestations of the regional ethnic (usually attached to a personal name) occur outside the region in question, perhaps as a simple shorthand applied by, or directed to, outsiders uninterested in, or uncomprehending of, the complex identities possible in the home region. Thus, for example, in a likely Archaic instance,¹⁰³ one Echembrotos described himself as Arkas on a tripod dedicated to Herakles at Thebes in celebration of a Pythian victory (and the place of dedication makes it plausible that Echembrotos was resident in Boiotia).¹⁰⁴ Alternatively, there are hints of the later practice of using ethnics of both kinds in the home region in contexts, such as sanctuaries, frequented by foreigners or where locals and foreigners worked together.¹⁰⁵ Hence, for example, the occasional appearance of regional-ethnic names among Archaic potter and painter signatures in the Corinthia (one Lokris and a name ending in –phoke on a pinax dedicated at Penteskouphia), as well as the Qorinthios noted above as a dedicator at Pitsa.¹⁰⁶ If, as this rather fragmentary evidence implies, external perceptions were of particular importance in promoting the deployment of regional ethnics, one should not underrate the consequences for internal perceptions also.

⁹⁸ Jones 1997, 79, 85–87.

⁹⁹ Ducat 1994; Lotze 1959.

¹⁰⁰ On the distinction between the terms, see Hansen 1996a, 174–176, 181–190. The picture presented by Boiotia (Hansen 1995b, 30–34, with app.1) and Arkadia (Heine Nielsen 2002, chapter 5) seems typical.

¹⁰¹ McInerney 1999, 8–9.

¹⁰² Morgan 2003, 102–105 (Thessaly, quotation p. 104), 175 (Arkadia). Even the Arkadian Azanes are ignored – only Pheneos is mentioned and then as an Arkadian settle-

ment: Heine Nielsen/Roy 1998, 13.

¹⁰³ Pausanias 10.7.6.

¹⁰⁴ Heine Nielsen 2002, 55 (see more generally 54–57); Morgan 2003, 210–211.

¹⁰⁵ Hansen 1996a, 179–180.

¹⁰⁶ Wachter 2001, COP 63 (Lokris and –phoke), COP App1Ad (Qorinthios). While much should now be added to the list of ethnic personal names in Bechtel 1917, 536–544, the impression that 6th-century evidence is comparatively slight remains accurate.

Evidence of this kind certainly confirms the plurality of registers in which political decisions were located and personal identity constructed by the end of the 6th century. But the archaeological record offers the best prospect of gaining both chronological depth and an understanding of the full complexity of individual cases. On this basis, we can attempt to trace the emergence of situations where one might expect to find strong marking of identity, in turn introducing the predictive element which has been so lacking in past work. To give but one example, it is easy to envisage circumstances under which the central part of the north coast of the Peloponnese might be subsumed under the general heading of 'Achaia', for example in geographical statements for which this provides the salient level of detail ('beyond Achaia lies Elis', rather than 'beyond Pellene lies Aegira and then Elis'), or (as already noted) by Achaians overseas seeking a basis for their shared identity. But an added dimension to the specific place identities of north coast settlements like Aegira or Aigai derives from the fact that Aigion is one of the finest natural ports along the Gulf. One might therefore predict that certain categories of people would hold specific knowledge of this site – navigators and traders, for example, including those from the Peloponnesian interior seeking access to markets – thus promoting the wider salience of personal identification via the city ethnic. Access to imports also formed a distinctive part of the way in which the city's residents celebrated key aspects of their personal and group identity (in graves and via dedications at the inland sanctuary at Ano Mazaraki).¹⁰⁷ Equally, given the conjunction of the port and a major road leading inland from Aigion which provides rare access through the mountains to northern Arkadia and thence westwards to Patras, one might expect control of this route to be marked and the identity of groups in the area signalled to neighbours and those travelling through. Hence the spectacular 8th-century investment in a temple at Ano Mazaraki and the strong material marking of identity by the Achaian and Azanian-Arkadian communities neighbouring each other in the upland plains. Echoing the emphasis placed on context rather than typology, it is not surprising to find that the exact form taken by this signalling varied over time, but responded to shared frames of reference. It is in this context that we find the short-lived ethnos of the Azanes.¹⁰⁸ It was in order to investigate plurality of this kind at a regional level, and trace how and why supra-polis and/or pan-regional identity could become politically salient, that I chose to focus on identification of the different means by which individuals' activities and associated social personae were articulated, at what level of integration they operated, and how they interrelated. To a great extent this involved using tools and approaches more highly developed in other branches of archaeology, for example in considering the dynamics of settlement growth, the social construction of landscape, sacral economics, and the concept of social boundaries in relation to technology and the chain of consumption.

At least during the Early Iron Age and early Archaic period, social groupings such as those generated by sanctuary activity, various manufacturing and subsistence activities, political and city life, intersected but were not coterminous.¹⁰⁹ There is no strong connection between settlement centres and manufacturing.¹¹⁰ The role of sanctuaries as manufacturing centres meant that they were at least as likely to house activities like metalworking as, for example settlements such as Oropos, or rural locations such as that of the smithy noted by Hesiod.¹¹¹ During the Archaic period, there is an emerging distinction between the production of commodities such as pottery, which integrate resources, manpower and markets across wider areas, and which can be undertaken in a wide variety of contexts, and activities, like quarrying and

¹⁰⁷ Morgan/Hall 1996, 176–179; Gadolou 1996–1997; Petropoulos 2002, 148–150.

¹⁰⁸ Morgan 2003, 176–187, summarising a large body of archaeological research.

¹⁰⁹ For analogous reflections focused on the role of cities, see Horden/Purcell 2000, chapter 4 (esp. 4.3).

¹¹⁰ Morgan 2003, 71–73.

¹¹¹ Hesiod, *Works and Days*, 493–494. Risberg 1992; Blakely 2006. Oropos: Mazarakis Ainian 1998, 196–198, 202–203.

stoneworking, which may have greater value in enhancing the status of those involved in commission and supply, but which are by definition more specifically located.¹¹²

Links between cities and political authority are equally non-exclusive. In particular, the epigraphical record highlights the dependence of 'secular' upon 'divine' authority in the enforcement of state laws and decrees. In rare instances, divine authority is directly involved in the civil process. A late 6th-century inscription from the agora at Mantinea records the judicial procedure used to try thirteen men in a case of murder,¹¹³ with the sentence (loss of property and banishment from the sanctuary) given by 'divine oracle and human judgement', and reinforced by a curse. This is at present a unique procedure, and we have no idea how it operated in practice: its oddity may be explained by the fact that the offence had apparently taken place in the sanctuary. Much more commonly, civil procedures were supported by the threat of divine sanction, often in the form of a curse, with the inscribed texts displayed either in the settlement or the guarantor sanctuary or both, thus adding the authority of place to that of text.¹¹⁴ The relationship between Elis and Olympia is such a case, especially as the view that the shrine served as the political centre of the Elean state before the synoikism of 471 has now been called into question, not least thanks to full presentation of pre-synoikism archaeological evidence from the city.¹¹⁵ Emphasising the very limited extent of excavation at Elis, it is interesting to find one counterpart for the large collection of 6th-century bronze decrees long known from Olympia,¹¹⁶ although we can only speculate about the relationship of display which it represents. Clearly, however, the decision to display decrees and treaties at Olympia was a real choice, and possible factors include the role of Olympian Zeus as guarantor, and the advantage that the use of a long-established and much frequented sanctuary may have conferred in ensuring the compliance of smaller neighbours in Elis' rather predatory attempts to define her boundaries during the 6th century (a prominent theme in these decrees).¹¹⁷ It is, however, important to stress that the choice of a particular deity as a guarantor was not innocent. The fact that every deity had a cult community and a priesthood, who would thus be given a particular importance, made it a social statement in its own right.

In the same vein, we should briefly note two other particularly important forms of association which functioned, at least in part, beyond city centres. Cult organisations were regulated social entities often of long standing, which operated on both a symbolic and practical level, not least as major consumers and producers. Rituals and offerings reflected and reinforced aspects of the social status of participants, and together with the expenses of sanctuary maintenance, provided important opportunities for individuals to display their economic means and gain not merely social standing but the chance to benefit from the by-products of a festival (hides, bone etc.). However, there is no reason to assume that sacral and city economies were coterminous (especially as some sanctuaries served more than one polis). It is the archaeological record which permits detailed documentation of patterns of consumption over time; how much of what was required and when, how were resource provision and storage managed, how were secondary products recycled or disposed of, and how were non-perishable resources, like metal dedications, maintained and treated after they were removed from display?¹¹⁸ Secondly, and perhaps most importantly of all, the definition of group territory reflected a palimpsest of spatial concerns.¹¹⁹ What land was required for what purpose, was it 'owned' by the group or was access negotiated (and if so, how regularly

¹¹² I am grateful to Chris Hayward for discussion of his continuing work on the Corinthian stone industry: Hayward 2003. For a general review, see Osborne 1987, 81-92.

¹¹³ Thür/Taeuber 1994, no. 8; Taeuber 1987-1988, 354-355; Thür 2001, including a review of previous interpretations.

¹¹⁴ Hölkeskamp 2000.

¹¹⁵ Morgan 2003, 75-76, 80. Elis: Eder/Mitsopoulou-Leon 1999.

¹¹⁶ Siewert 2001, 245-249.

¹¹⁷ I owe this observation to Jim Roy; on the form and creation of perioikic relationships, see Roy 1997 and 2002.

¹¹⁸ Morgan 2003, 142-155.

¹¹⁹ Morgan 2003, chapter 4.

and how many other groups were involved), and in what ways and with what frequency were group members thus required to measure the social distance which separated them from the ‘others’ whom they encountered? Within this framework we may also consider archaeological phenomena such as the creation and subsequent interpretation of public monuments (not merely shrines, but also for example the location and monumentalisation of cemeteries, and the erection of isolated reliefs), all of which can serve as vital symbols for the articulation of social memory.¹²⁰

Observations of this kind may seem to be a simple matter of joining up thinking in different areas. Yet by emphasising the equal importance (and potential independence) of these various forms and contexts of association, we may avoid the positivistic tendency to concentrate on what is most visible in the record (hence my earlier emphasis on the problems of reading big sites in later polis terms). Moreover, considering these different kinds and levels of association as palimpsests gives wider scope for investigating how and on what level they were embedded within geographically wider movements, processes and systems – the Corinthian and Achaian connections with the Gulf milieu and different parts of Italy noted at the start of this article being cases in point. Factors affecting the variety of associations and identities within regions include the nature and diversity of settlement strategies (i.e. the potential for differently constituted local place identities) and their connection with environmental diversity (i.e. the resulting degree of economic interdependence within and between regions, however constituted in practice). Processes affecting the manner of embedding of particular identities within wider supra-regional associations include geographical expansion of settlement, perhaps involving occupation, as that of Phokis by Thessaly,¹²¹ or outright conquest, such as the Spartan subjection of Messenia,¹²² and internal and external demographic mobility via colonisation, warfare etc.¹²³ Likewise, the varying need and potential for definition by opposition with neighbours is clear from the very varied dates at which frontiers were defined.¹²⁴ And the role of communication routes must also be considered. Land routes which connected with major waterways, like the Corinthian Gulf, were especially important in linking coastal and upland settlement, providing access to markets for mountain economies (as those of Arkadia),¹²⁵ and facilitating communication between neighbouring communities often very different in organisation.¹²⁶ Understanding the social contexts so created opens opportunities for a more sophisticated approach to a broad range of issues – artefact style, for example, long linked with group identity. One might cite the brief emergence of elaborately decorated pottery in ‘interstitial’ areas like the major communication routes through inland Achaia, which drew on the style pools of the areas which they connected.¹²⁷ Indeed, a new twist

¹²⁰ Alcock 2002.

¹²¹ See McInerney 1999, chapter 6, for a full discussion of the consequences for the embedding of Thessalian identity within various Phokian and central Greek forms of association.

¹²² Shipley 1997.

¹²³ Morgan 2003, 196–205.

¹²⁴ The frontier zone between Achaia (i.e. Aigion) and northern Arkadia/Azania is one of the earliest to be so marked; see above and Morgan 2002, 108–109. Elis: Roy 2000 for discussion of the Elean–Arkadian frontier; see also Roy 2002 on the formation of the internal and perioikic relationships by which Elis emerged an entity through the 6th century. The frontier between Achaia and Elis was of little salience in the pre-Classical period, not least as little evidence of pre-6th century settlement

has so far been discovered in the Dyme area (Lakaki-Marchetti 2000; Papagiannopoulos/Zachos 2000; Morgan/Hall 1996, 186–189); the ‘Archaic’ temple at Santameri is at present the earliest evidence of symbolic construction in the frontier zone (*Αρχαιολογικόν Δελτίον* 22B, 1967, 216). The impact of external relations on the creation and marking of group identity is particularly clear in Arkadia, where it contributed to the fragmentation of subzones: Morgan 1999c, esp. 425–432.

¹²⁵ Roy 1999.

¹²⁶ The fullest review of the kinds of issues implied in these observations is Horden/Purcell 2000, chapter 5. Morgan 2003, chapters 4 and 5 includes discussion of the factors underlying Peloponnesian and central Greek interconnectivity.

¹²⁷ See above, and Morgan 2003, 181–183.

on the old active versus passive debate surrounding style generation has been given by the application of Darwinian theory, and especially the notion of niche, to material symbolism.¹²⁸

5 CONCLUSION

The kind of observations presented in this article offer scope for reappraisal in a wide variety of early Mediterranean circumstances. A major advantage of such a ‘bottom-up’ approach, accepting as normal the existence of different registers of activity (and related group closure) and the potential for dissonance between them, and seeking case by case to identify and predict points of tension where identity would be likely to have become a particularly important issue, is that it is not limited by the scope of the written record. A variety of issues have been raised which we would not expect to find covered in the available texts. As is evident from the manner in which epigraphic evidence has been cited throughout this article, the actual content of texts is often of less interest than the way in which they relate to the performative aspects of language deployment, as material as much as literary statements. My focus on identifying and predicting points of tension also allows us to move back beyond the adoption of alphabetic writing to examine the longer term history of identity construction. In considering the Bronze Age/Iron Age transition in the western Peloponnese, for example, an important area of investigation concerns transformations in the treatment of certain forms of equipment and the practice of certain activities which had served as symbols of what, from a purely modern perspective, we might term Mycenaean identity.¹²⁹ These include ritual dining and distinctive forms of burnt sacrifice, which during LHIIIB were conducted in the closed and socially exclusive setting of the palace at Pylos,¹³⁰ but which reappeared, perhaps as little as 50 years after the destruction of the palace, in the open air setting of the new sanctuary at Olympia, following a major shift in regional settlement.¹³¹ Furthermore, among the earliest and most elaborate vessels at Olympia are *kylikes*, a shape central to Mycenaean ritual, and perhaps thus carrying a burden of inherited meaning.¹³² In partial contrast, weapons and images of warfare, which were equally central to Mycenaean identity,¹³³ had a more limited survival. There is a striking number of rich warrior graves in LHIIIC Achaia (especially in the west of the region), but the phenomenon did not continue beyond this period.¹³⁴ These two examples well illustrate the questions raised by the fate of politically-charged symbols as the social contexts within which power was expressed were reshaped. Some symbols may simply disappear; but while others retained a basic political charge, the nature of the identity expression in which they were implicated changed. Reading the resulting ‘cultural biographies’ is an important challenge, even if they tend to raise more questions than can currently be answered.

Overall, the wide range of questions and observations presented here add up to a complex analysis which can be approached from a number of different viewpoints. Indeed, it may not seem obvious that what is primarily an unpacking of certain forms of regional complexity has much to do with ethnicity. I would, however, argue that this is the only way forward if we are to understand how the process of ethnicity could operate, why specific ethnic groups gained and lost political salience, and to move beyond the descriptive level of much present work. If I have one major criticism of approaches to ethnicity in Classical scholarship to date, it has been that we have sometimes pursued the quick fix in looking for evidence that can be pinned down rather superficially as ethnic identity pure and simple. Considering

¹²⁸ Maschner/Mithen 1996; Shennan 1996.

¹²⁹ Bennet 1999.

¹³⁰ Isaakidou/Halstead/Davis/Stocker 2002; on dining, see Killen 1994.

¹³¹ Eder 2001a; Eder 2001b; Kyrieleis 2002.

¹³² Eder 2001a, 206–208.

¹³³ Davis/Bennet 1999.

¹³⁴ The evidence is reviewed by Eder 2003; see also Papadopoulos 1999.

the ancient Greek world from the standpoint of what has been achieved in the social sciences, we have far to go in exploring the full potential of the material record in particular.

This article has ranged widely in presenting issues central to the formulation of effective research designs appropriate to the circumstances of the southern and central Greek mainland. While many of these issues are of general relevance, an appropriate design to investigate ethnic expression during the same period in the very different circumstances of, for example, the Cycladic islands, would present a new range of challenges. Equally, while this chapter is different in many respects from other contributions in this volume, there are wider general implications (especially for research design) which need to be worked through as appropriate to each period and region. Ethnic groups, for better or worse, have been an important aspect of the analysis of Greek and Roman political structures for well over a century, and throughout have been entwined with modern political preconceptions. This article continues the process by examining the implications of recent developments in approaches to early Greek political groupings which move beyond the polis-obsession of the later 19th and much of the 20th centuries. These offer hope of real progress because they require research designs which force continuing re-evaluation of the nature of social complexity, and especially issues of group closure, and begin to address problems of prediction and explanation. If this serves to remove theoretical straightjackets while bringing large but neglected bodies of data into prominence, so much the better.

ABBREVIATIONS

BSA *Annual of the British School at Athens*
ZPE *Zeitschrift für Papyrologie und Epigraphik*

REFERENCES

- Albanese Procelli, R.M., 1991: Importazioni greche nei centri interni della Sicilia in età arcaica: aspetti dell' «acculturazione», in *I vasi attici ed altre ceramiche coeve in Sicilia* vol.2, *Cronache di Archeologia* 30, 97-111.
- Albanese Procelli, R.M., 1996: Appunti sulla distribuzione delle anfore commerciali nella Sicilia arcaica, *Kokalos* 42, 91-137.
- Albanese Procelli, R.M., 1997: Echanges dans la Sicilie archaïque: Amphores commerciales, intermédiares, et redistribution en milieu indigène, *Revue Archéologique*, 3-25.
- Alcock, S., 2002: *Archaeologies of the Greek past. Landscape, monuments, and memories*, Cambridge.
- Antonaccio, C.M., 1997: Urbanism at Archaic Morgantina, in H. Damgaard Andersen/H.W. Horsnæs/S. Houby-Nielsen/A. Rathje (eds), *Urbanism in the Mediterranean in the 9th-6th centuries BC*, Copenhagen (Acta Hyperborea 7), 167-193.
- Antonaccio, C.M., 2001: Ethnicity and colonization, in I. Malkin (ed.), 113-157.
- Antonaccio, C.M., 2003: Hybridity and the cultures withi Greek culture, in C. Dougherty/L. Kurke (eds), *The cultures within ancient Greek culture*, Cambridge, 57-74.
- Antonaccio, C.M., 2006: Elite mobility in the west, in S. Hornblower/C. Morgan (eds), *Pindar's poetry, patrons and festivals. From Archaic Greece to the Roman Empire*, Oxford, 265-285.
- Antonaccio, C.M./J. Neils, 1995: A new grafitto from Archaic Morgantina, *ZPE* 101, 261-277.
- Aupert, P., 1982: Argos aux VIIIe-VIIe siècles: bourgade ou métropole?, *Annuario della scuola Archeologica di Atene* 60, 21-32.
- Barth, F. (ed.), 1969: *Ethnic groups and boundaries*, Boston.
- Bats, M./B. d'Agostino (eds), 1998: *Euboica. L'Eubea e la presenza euboica in Calcidia e in Occidente*, Napoli.

- Bechtel, F., 1917: *Die historischen Personennamen des Griechischen bis zur Kaiserzeit*, Halle.
- Bennet, J., 1999. The meaning of 'Mycenaean': speculation on ethnicity in the Aegean Late Bronze Age, *Bulletin of the Institute of Classical Studies* 43, 224.
- Blakely, S., 2006: *Myth, ritual and metallurgy in ancient Greece and recent Africa*, Cambridge.
- Bourdieu, P., 1977: *Outline of a theory of practice*, Cambridge.
- Cerdá, I., 1868-1871: *Teoría general de la urbanización*, Barcelona.
- Childe, V.G., 1933: Is prehistory practical?, *Antiquity* 7, 410-418.
- Cinquantaquattro, T., 2001: *Pontecagnano II.6. L'agro Picentino e la necropoli di località Casella*, Napoli.
- Cohen, B., 2001: Ethnic identity in democratic Athens and the visual vocabulary of male costume, in I. Malkin (ed.), 235-274.
- Coldstream, J.N., 1983: The meaning of the regional styles in the eighth century B.C., in R. Hägg (ed.), *The Greek renaissance of the eighth century B.C.. Tradition and innovation*, Stockholm, 17-25.
- Coldstream, J.N., 1996: Knossos and Lefkandi. The Attic connections, in D. Evely/I. Lemos/S. Sherratt (eds), *Minotaur and centaur*, Oxford, 133-145.
- Coldstream, J.N., 1998: Achaean pottery around 700 B.C., at home and in the colonies, in D. Katsonopoulou/S. Soter/D. Schilardi (eds), *Helike II. Ancient Helike and Aigialeia*, Athens, 323-334.
- Crielaard, J.P., 2000: Honour and valour as discourse for early Greek colonialism (8th-7th centuries B.C.), in F. Krinzinger (ed.), *Die Ägäis und das westliche Mittelmeer. Beziehungen und Wechselwirkungen 8. bis 5. Jh. v. Chr.*, Wien, 499-506.
- Crielaard, J.P./V. Stissi/G.J. van Wijngaarden (eds), 1999: *The complex past of pottery*, Amsterdam.
- Csapo, E., 1991: An international community of traders in late 8th-7th c. B.C. Kommos in southern Crete, *ZPE* 88, 211-216.
- Csapo, E., 1993: A postscript to 'An international community of traders in late 8th-7th c. B.C. Kommos', *ZPE* 96, 235-236.
- Csapo, E./A.W. Johnston/D. Geagan, 2000: The Iron Age inscriptions, in J.W. Shaw/M.C. Shaw (eds), *Kommos IV. The Greek sanctuary*, Princeton, 101-134.
- d'Agostino, B., 1999: I principi dell'Italia centro-tirrenica in epoca orientalizzante, in P. Ruby (ed.), *Les princes de la protohistoire et l'émergence de l'état*, Naples/Rome (Collection du Centre Jean Bérard 17/ Collection de l'École française de Rome 252), 81-88.
- d'Agostino, B./D. Ridgway (eds), 1994: *APOIKIA. Scritti in onore di Giorgio Buchner*, Naples (*AION* n.s. 1).
- D'Andria, F., 1995: Corinto e l'occidente. La costa Adriatica, in *Corinto e l'Occidente. Atti del 34 ° convegno di studi sulla Magna Grecia, Taranto 7-11 ottobre 1994*, Taranto, 457-508.
- Davies, J.K., 1997: The 'origins of the Greek polis'. Where should we be looking?, in L.G. Mitchell/P.J. Rhodes (eds), 24-38.
- Davis, J./J. Bennet, 1999: Making Mycenaeans. Warfare, territorial expansion, and representation of the other in the Pylian kingdom, in R. Laffineur (ed.), 105-120.
- Dehl, C., 1982: *Die korinthische Keramik des 8. und frühen 7. Jh. V. Chr. in Italien. Untersuchungen zu Ihrer Chronologie und Ausbreitung*, Berlin (Athenische Mitteilungen, Beiheft 11).
- Ducat, J., 1994: *Les pénestes de Thessalie*, Besançon (Annales littéraires de l'Université de Besançon 512).
- Eder, B., 2001a: Continuity of Bronze Age cult at Olympia? The evidence of the Late Bronze Age and Early Iron Age pottery, in R. Laffineur/R. Hägg (eds), *POTNIA. Deities and religion in the Aegean Bronze Age. Proceedings of the 8th international Aegean conference, Göteborg 12-15 April 2000*, Liège (Aegaeum 23), 201-219.
- Eder, B., 2001b: Die Anfänge von Elis und Olympia. Zur Siedlungsgeschichte der Landschaft Elis am Übergang von der Spätbronze- zur Früheisenzeit, in V. Mitsopoulos-Leon (ed.), 233-243.
- Eder, B., 2003: Patterns of contact and communication between the regions south and north of the Corinthian Gulf in LHIIIC, in *The periphery of the Mycenaean world: 2nd international interdisciplinary colloquium, Lamia 26-30 Sept. 1999*, Lamia, 37-54.

- Eder, B./V. Mitsopoulos-Leon, 1999: Zur Geschichte der Stadt Elis vor dem Synoikismos von 471 v. Chr., *Österreiches Jahresheft* 68, 1–39.
- Effenterre, H. van/F. Ruzé, 1994: *Nomima. Recueil d'inscriptions politiques et juridiques de l'archaïsme grec I*, Rome.
- Ehrenberg, V., 1969: *The Greek state*, 2nd ed., London.
- Flensted-Jensen, P. (ed.), 2000: *Further studies in the ancient Greek polis*, Stuttgart (Historia Einzelschriften 138).
- Forsén, J./B. Forsén/E. Østby, 1999: The sanctuary of Agios Elias – its significance, and its relations to surrounding sanctuaries and settlements, in T. Heine Nielsen/J. Roy (eds), 169–191.
- Gadolou, A., 1996–1997: Χάλκινα και Σιδερένια όπλα από το Ιερό στο Άνω Μαζαράκι (Ρακίτα) Αχαΐας. Μια Πρώτη Παρουσίαση. *Πρακτικά του Ε' Διεθνούς Συνεδρίου Πελοποννησιακών Σπουδών, 6-10 Σεπτ. 1995*, Athens, 51–72.
- Giangiulio, M., 1989: *Ricerca su Crotone arcaica*, Pisa.
- Giangiulio, M., 2002: I culti delle colonie achee d'occidente. Strutture religiose e matrici metropolitane, in E. Greco (ed.), 283–313.
- Greco, E. (ed.), 2002: *Gli Achei a l'identità etnica degli Achei d'occidente*, Paestum.
- Hall, J.M., 1997: *Ethnic identity in Greek antiquity*, Cambridge.
- Hall, J.M., 2002: *Hellenicity. Between ethnicity and culture*, Chicago/London.
- Hall, J.M., 2003: “Culture” or “cultures”? Hellenism in the late sixth century, in C. Dougherty/L. Kurke (eds), *The cultures within ancient Greek culture*, Cambridge, 23–34.
- Hansen, M.H., 1995a: The “autonomous city-state”. Ancient fact or modern fiction?, in M.H. Hansen/K. Raaflaub (eds), *Studies in the Archaic Greek polis*, Stuttgart (Historia Einzelschriften 95), 21–43.
- Hansen, M.H., 1995b: Boiotian *poleis* – a test case, in M.H. Hansen (ed.), 13–64.
- Hansen, M.H. (ed.), 1995: *Sources for the ancient Greek city-state. Acts of the Copenhagen Polis Centre 2*, Copenhagen.
- Hansen, M.H., 1996a: City-ethnics as evidence for *polis* identity, in M.H. Hansen/K. Raaflaub (eds), 169–196.
- Hansen, M.H., 1996b: ΠΟΛΛΑΧΩΣ ΠΟΛΙΣ ΛΕΓΕΤΑΙ (Arist. Pol. 1267a23). The Copenhagen inventory of *poleis* and the *lex hafniensis de civitate*, in M.H. Hansen (ed.), 7–72.
- Hansen, M.H. (ed.), 1996: *Introduction to an inventory of poleis. Acts of the Copenhagen Polis Centre 3*, Copenhagen.
- Hansen, M.H. (ed.), 1997: *The polis as an urban centre and as a political community. Acts of the Copenhagen Polis Centre 4*, Copenhagen.
- Hansen, M.H., 1997a: The *polis* as an urban centre. The literary and epigraphical evidence, in M.H. Hansen (ed.), 9–86.
- Hansen, M.H., 1997b: A typology of dependent *poleis*, in T. Heine Nielsen (ed.), 29–37.
- Hansen, M.H., 1998: *Polis and city-state. An ancient concept and its modern equivalent. Acts of the Copenhagen Polis Centre 5*, Copenhagen.
- Hansen, M.H., 2000: A survey of the use of the word *polis* in Archaic and Classical sources, in P. Flensted-Jensen (ed.), 173–215.
- Hansen, M.H., 2006: Ethnics as evidence for *polis* identity, in M.H. Hansen/T. Heine Nielsen (eds), *An inventory of Archaic and Classical poleis*, Oxford, 58–69.
- Hansen, M.H./K. Raaflaub (eds), 1996: *More studies in the Archaic Greek polis*, Stuttgart (Historia Einzelschriften 108).
- Hayward, C.L., 2003: Geology of Corinth. Study of a basic resource, in C.K. Williams II/N. Bookidis (eds), *Corinth XX. The centenary, 1896-1996*, Princeton, 15–42.
- Heine Nielsen, T., 1996: Arkadia. City-ethnics and tribalism, in M.H. Hansen (ed.), 117–163.
- Heine Nielsen, T., 1997: *Triphylia*. An experiment in ethnic construction and political organisation, in T. Heine Nielsen (ed.), 129–162.

- Heine Nielsen, T. (ed.), 1997: *Yet more studies in the ancient Greek polis*, Stuttgart (Historia Einzelschriften 117).
- Heine Nielsen, T., 1999: The concept of Arkadia – the people, their land, and their organisation, in T. Heine Nielsen/J. Roy (eds), 16–88.
- Heine Nielsen, T., 2002: *Arkadia and its poleis in the Archaic and Classical periods*, Copenhagen.
- Heine Nielsen, T./J. Roy, 1998: The Azanians of northern Arkadia, *Classica et Mediaevalia* 49, 5–44.
- Heine Nielsen, T./J. Roy (eds), 1999: *Defining ancient Arkadia. Acts of the Copenhagen Polis Centre* 6, Copenhagen.
- Herman, G., 1987: *Ritualised friendship and the Greek city*, Cambridge.
- Hölkeskamp, K.-J., 2000: (In-)Schrift und Monument. Zum Begriff des Gesetzes im archaischen und klassischen Griechenland, *ZPE* 132, 73–96.
- Horden, P./N. Purcell, 2000: *The corrupting sea. A study of Mediterranean history*, Oxford.
- Isaakidou, V./P. Halstead/J. Davis/S. Stocker, 2002: Burnt animal sacrifice at the Mycenaean ‘Palace of Nestor’, Pylos, *Antiquity* 76, 86–92.
- Jameson, M./C., Runnels/T. van Andel, 1994: *A Greek countryside*, Stanford.
- Johnston, A.W., 1999: Epichoric alphabets. The rise of the polis or a slip of the pen?, in N. Dimoudis (ed.), *The history of the Hellenic language and writing*, Altenburg, 419–433.
- Jones, S., 1997: *The archaeology of ethnicity*, London.
- Jost, M., 1999: Les schémas de peuplement de l’Arcadie aux époques archaïque et classique, in T. Heine Nielsen/J. Roy (eds), 192–247.
- Joyner, L., 1997: Byzantine and Frankish cooking wares at Corinth, Greece. Changes in diet, style and raw material exploitation, in A. Sinclair/E. Slater/J. Gowlett (eds), *Archaeological sciences 1995*, Oxford, 82–87.
- Karageorghis, V./N. Stampolidis (eds), 1998: *Eastern Mediterranean. Cyprus-Dodecanese-Crete 16th-6th cent. B.C.*, Athens.
- Killen, J., 1994: Thebes sealings, Knossos tablets, and Mycenaean state banquets, *Bulletin of the Institute of Classical Studies* 39, 67–81.
- Kyrieleis, H., 2002: Zu den Anfängen des Heiligtums von Olympia, in H. Kyrieleis (ed.), *Olympia 1875-2000*, Berlin, 213–220.
- Laffineur, R. (ed.), 1999: *POLEMOS. Le contexte guerrier en Égée à l’Age du Bronze*, Liège (Aegaeum 19).
- Lakaki-Marchetti, M., 2000: Σωστικές Ανασκαφές στην Κάτω Αχαγία, in A.D. Rizakis (ed.), 113–121.
- Lasserre, F., 1976: L’historiographie grecque à l’époque archaïque, *Quaderni di Storia* 4, 113–142.
- Leighton, R., 1993: *Morgantina IV. The protohistorical settlement*, Princeton.
- Leighton, R., 1999: *Sicily before history. An archaeological survey from the Palaeolithic to the Iron Age*, London.
- Little, L.M./J. Papadopoulos, 1998: A social outcast in Early Iron Age Athens, *Hesperia* 67, 375–404.
- Lotze, D., 1959: Μεταξύ Ελευθερών και Δούλων. *Studien zur Rechtsstellung unfreier Landbevölkerungen in Griechenland bis zum 4. Jahrhundert v. Chr.*, Berlin.
- Lyons, C., 1996: *Morgantina V. The Archaic cemeteries*, Princeton.
- Lyons, C./J. Papadopoulos, 2002: *The archaeology of colonialism*, Los Angeles.
- McInerney, J., 1999: *In the folds of Parnassos. Land and ethnicity in ancient Phokis*, Austin.
- McNairn, B., 1980: *The method and theory of V. Gordon Childe*, Edinburgh.
- Malkin, I., 1994: *Myth and territory in the Spartan Mediterranean*, Cambridge.
- Malkin, I. (ed.), 2001: *Ancient perceptions of Greek ethnicity*, Harvard.
- Malkin, I., 2002: A colonial middle ground. Greek, Etruscan, and local elites in the Bay of Naples, in C. Lyons/J. Papadopoulos (eds), 151–181.
- Maschner, H. (ed.), 1996: *Darwinian archaeologies*, New York/London.
- Maschner, H./S. Mithen, 1996: Darwinian archaeologies. An introductory essay, in H. Maschner (ed.), 3–14.
- Mazarakis Ainian, A., 1998: Oropos in the Early Iron Age, in M. Bats/B. d’Agostino (eds), 179–215.

- Miller, M., 1991: *Athens and Persia in the fifth century B.C. A study in cultural receptivity*, Cambridge.
- Mitchell, L.G./P.G. Rhodes (eds), 1997: *The development of the polis in Archaic Greece*, London.
- Mitsopoulos-Leon, V. (ed.), 2001: *Forschungen in der Peloponnes. Akten des Symposions zur 100-Jahr-Feier des Österreichischen Archäologischen Instituts Athen, Athen 5-7.3 1998*, Athens.
- Morgan, C., 1998: Euboians and Corinthians in the area of the Corinthian Gulf?, in M. Bats/B. d'Agostino (eds), 281-302.
- Morgan, C., 1999a: The archaeology of ethnicity in the colonial world of the eighth to sixth centuries BC. Approaches and prospects, in *Confini e frontiere nella grecità d'occidente. Atti del 37° convegno di studi sulla Magna Grecia, Taranto 3-6 Ottobre 1997*, Taranto, 85-145.
- Morgan, C., 1999b: Some thoughts on the production and consumption of Early Iron Age pottery in the Aegean, in J.P. Crielaard/V. Stissi/G.J. van Wijngaarden (eds), 213-259.
- Morgan, C., 1999c: Cultural subzones in Early Iron Age and Archaic Arkadia?, in T. Heine Nielsen/J. Roy (eds), 382-456.
- Morgan, C., 1999d: *Isthmia VIII. The Late Bronze Age settlement and Early Iron Age sanctuary*, Princeton.
- Morgan, C., 2000: Politics without the polis. Cities and the Achaean ethnos, c. 800-500 BC, in R. Brock/S. Hodkinson (eds), *Alternatives to Athens. Varieties of political organization and community in ancient Greece*, Oxford, 190-211.
- Morgan, C., 2001a: Figurative iconography from Corinth, Ithaca and Pithekoussai. Aetos 600 reconsidered, *BSA* 96, 195-227.
- Morgan, C., 2001b: Ethne, ethnicity, and early Greek states, ca.1200-480 B.C. An archaeological perspective, in I. Malkin (ed.), 75-112.
- Morgan, C., 2002: Ethnicity. The example of Achaia, in E. Greco (ed.), 95-116.
- Morgan, C., 2003: *Early Greek states beyond the polis*, London.
- Morgan, C., 2004: *Phanagoria I. Attic finewares of the Archaic to Hellenistic periods*, Leiden.
- Morgan, C., 2006: Ithaca between east and west. Eighth century human figure imagery from the sanctuary at Aetos, in E. Rystedt/B. Wells (eds), *Pictorial Pursuits. Figurative Painting on Mycenaean and Geometric Pottery*, Stockholm, 217-228.
- Morgan, C., forthcoming a: From Ionia to the Bosphorus. Motherland heritage and the material culture of the Bosphoran Kingdom, in P.G. Bilde /J. Hjarl Petersen (eds), *Meetings of Cultures in the Black Sea Region: between Conflict and Coexistence*, Aarhus.
- Morgan, C., forthcoming b: The elite of Aetos. Religion and power in Early Iron Age Ithaca, in A. Mazarakis Ainian (ed.), *The Dark Age Revisited*, Volos.
- Morgan, C./J.J. Coulton, 1997: The polis as a physical entity, in M.H. Hansen (ed.), 87-144.
- Morgan, C./J.M. Hall, 1996: Achaian poleis and Achaian colonisation, in M.H. Hansen (ed.), 164-232.
- Morris, I., 1991: The early polis as city and state, in J. Rich/A. Wallace-Hadrill (eds), *City and country in the ancient world*, London, 25-57.
- Neils, J., 1991: Attic vases from Morgantina, in *I vasi attici ed altre ceramiche coeve in Sicilia vol.2, Cronache di Archeologia* 30, 173-178.
- Osanna, M., 1996: *Santuari e culti dell'Acaia antica*, Perugia/Napoli.
- Osanna, M., 2002: Da Aigialos ad Achaia. Sui culti più antichi della madrepatria delle colonie achee di occidente, in E. Greco (ed.), 271-281.
- Osborne, R., 1987: *Classical landscape with figures*, London.
- Osborne, R., 1998: Early Greek colonization? The nature of Greek settlement in the west, in N. Fisher/H. van Wees (eds), *Archaic Greece: new approaches and new evidence*, London, 251-269.
- Papadopoulos, J., 1996: Euboians in Macedonia? A closer look, *Oxford Journal of Archaeology* 15, 151-181.
- Papadopoulos, J., 1997: Innovations, imitations and ceramic style. Modes of production and modes of dissemination, in *TEXNH. Craftsmen, craftswomen and craftsmanship in the Aegean Bronze Age II*, Liège/Austin (Aegaeum 16), 449-462.

- Papadopoulos, J., 2001: Magna Achaëa. Akhaian Late Geometric and Archaic pottery in South Italy and Sicily, *Hesperia* 70, 373-460.
- Papadopoulos, J., 2002: Minting identity. Coinage, ideology and the economics of colonization in Akhaian Magna Graecia, *Cambridge Archaeological Journal* 12, 21-55.
- Papadopoulos, Th., 1999: Warrior-graves in Achaean Mycenaean cemeteries, in R. Laffineur (ed.), 268-274.
- Papagiannopoulos, K.V./G.A. Zachos, 2000: Εντατική Επιφανειακή Έρευνα στη Δυτική Αχαΐα. Μια άλλη προσέγγιση, in A.D. Rizakis (ed.), 139-153.
- Parakosta, L., 1991: Παρατηρήσεις σχετικά με την Τοπογραφία του Αρχαίου Αιγίου, in A. Rizakis (ed.), *Αρχαία Αχαΐα και Ηλεία*, Athens/Paris, 235-240.
- Parise, N., 2002: Monetazione incusa ed identità politica nelle colonie Achee d'Occidente, in E. Greco (ed.), 389-396.
- Patterson, O., 1975: Context and choice in ethnic allegiance. A theoretical framework and Caribbean case study, in N. Glazer/D. Moynihan (eds), 305-349.
- Pelagatti, P., 1982. I più antichi materiali di importazione a Siracusa, a Naxos e in altri siti della Sicilia Orientale, in G. Vallet (ed.), *La céramique grecque ou de tradition grecque au VIIIe siècle en Italie centrale et méridionale*, Naples, 113-180.
- Perlman, P., 1996: Πόλις Υπήκοος. The dependent polis and Crete, in M.H. Hansen (ed.), 233-287.
- Petropoulos, M., 1985: Τοπογραφικά Βόρειας Αρκαδίας, *HOROS* 3, 63-73.
- Petropoulos, M., 2002: The geometric temple of Ano Mazaraki (Rakita) in Achaia during the period of colonisation, in E. Greco (ed.), 143-164.
- Philipp, H., 1992: Le caratteristiche delle relazioni fra il santuario di Olimpia e la Magna Grecia, in *La Magna Grecia e i grandi santuari della Madrepatria. Atti del 31° convegno di studi sulla Magna Grecia, Taranto Ottobre 1991*, Taranto, 29-51.
- Philipp, H., 1994: Olympia, die Peloponnes und die Westgriechen, *JdI*, 77-92.
- Pikoulas, Y., 1981-1982: Η Αρκαδική Αζάνια, Πρακτικά του Β' Διεθνούς Συνεδρίου Πελοποννησιακών Σπουδών, Πάτρα 25-31 Μαΐου 1980, II, Athens, 269-281.
- Principi: Principi etruschi tra Mediterraneo ed Europa*, Venice 2000.
- Polignac, F. de, 1998: Divinités régionales et divinités communautaires dans les cités archaïques, in V. Pirenne-Delforge (ed.), *Les panthéons des cités des origines à la Périégèse de Pausanias*, Liège, (Kernos, supp.8), 23-34.
- Purcell, N., 1997: Review of G.R. Tsetschladze and F. de Angelis (eds), The archaeology of Greek colonisation. Essays dedicated to Sir John Boardman, *Antiquity* 71, 500-502.
- Raubitschek, I., 1998. *Isthmia VII. The metal objects (1952-1989)*, Princeton.
- Ridgway, D., 1992: *The first western Greeks*, Cambridge.
- Ridgway, D., 2000: The first western Greeks revisited, in D. Ridgway/F. Serra Ridgway/M. Pearce/E. Herring/R.D. Whitehouse/J.B. Wilkins (eds), *Ancient Italy in its Mediterranean setting. Studies in honour of Ellen Macnamara*, London, 179-191.
- Risberg, C., 1992: Metal-working in Greek sanctuaries, in T. Linders/B. Alroth (eds), *Economics of cult in the Greek world*, Uppsala, 33-40.
- Rizakis, A.D. (ed.), 2000: *Paysages d'Achaïe II. Dymé et son territoire*, Athènes/Paris.
- Robertson, G., 1997: Evaluating the citizen in Archaic Greek lyric, elegy and inscribed epigram, in L.G. Mitchell/P.G. Rhodes (eds), 148-157.
- Robertson, M., 1948: Excavations in Ithaca, V. The Geometric and later finds from Aetos. The pottery, *BSA* 43, 9-124.
- Roy, J., 1996: Polis and tribe in Classical Arkadia, in M.H. Hansen/K. Raaflaub (eds), 107-112.
- Roy, J., 1997: The perioikoi of Elis, in M.H. Hansen (ed.), 282-320.
- Roy, J., 1999: The economics of Arkadia, in T. Heine Nielsen/J. Roy (eds), 320-381.

- Roy, J., 2000: The frontier between Arkadia and Elis in Classical antiquity, in P. Flensted-Jensen/T. Heine Nielsen/L. Rubinsten (eds), *Polis and politics. Studies in ancient Greek history presented to Mogens Herman Hansen on his sixtieth birthday, August 20, 2000*, Copenhagen, 133-156.
- Roy, J., 2002: The synoikism of Elis, in T. Heine Nielsen (ed.), *Even more studies in the ancient Greek polis*, Copenhagen (Historia Einzelschriften 162), 249-264.
- Schachter, A., 2000: Greek deities. Local and panhellenic identities, in P. Flensted-Jensen (ed.), 9-17.
- Shennan, S. 1989. Introduction: archaeological approaches to cultural identity, in S. Shennan (ed.), 1-32.
- Shennan, S. (ed.), 1989: *Archaeological approaches to cultural identity*, London.
- Shennan, S., 1996: Foreword, in Maschner (ed.), ix-xiii.
- Shipley, G., 1997: "The other Lakedaimonians". The dependent perioikic *poleis* of Laconia and Messenia, in M.H. Hansen (ed.), 282-320.
- Siewert, P., 2001: Zwei Rechtsaufzeichnungen der Stadt Elis, in V. Mitsopoulos-Leon (ed.), 245-252.
- Smith, A., 1986: *The ethnic origin of nations*, Oxford.
- Snodgrass, A.M., 1980: *Archaic Greece. The age of experiment*, London.
- Snodgrass, A.M. 1993: The rise of the polis. The archaeological evidence, in M.H. Hansen (ed.), *The ancient Greek city-state. Acts of the Copenhagen Polis Centre 1*, Copenhagen, 30-40.
- Snodgrass, A.M., 1994: A new precedent for westward expansion. The Euboeans in Macedonia, in B. d'Agostino/D. Ridgway (eds), 87-93.
- Snodgrass, A.M., 1999: Centres of pottery production in Archaic Greece, in M.-C. Villaneuva Puig/F. Lissarague/P. Rouillard/A. Rouveret (eds), *Céramique et peinture grecques. Modes d'emploi*, Paris, 25-33.
- Symeonoglou, N.E.W., 2002: *The Early Iron Age pottery and development of the sanctuary at Aetos*, PhD diss. Washington University in St Louis.
- Tauber, H., 1987-1988: Arcadian inscriptions as a source for ancient Greek law, *Πρακτικά του Γ' Διεθνούς Συνεδρίου Πελοποννησιακών Σπουδών, Καλαμάτα 8-15 Σεπτεμβρίου 1985 II*, Athens, 353-358.
- Tartaron, T. et al., 2006: The Eastern Korinthia Archaeological Survey. Integrated methods for a dynamic landscape, *Hesperia* 75, 453-523.
- Terrenato, N., 1998: The Romanization of Italy. Global acculturation or cultural *bricolage*?, in C. Forcey/J. Hawthorne/R. Witcher (eds), *Proceedings of the seventh annual theoretical Roman archaeology conference, Nottingham 1997*, Oxford, 20-27.
- Thomas, R., 1992: *Literacy and orality in ancient Greece*, Cambridge.
- Thomas, R., 1996: Written in stone? Liberty, equality, orality and the codification of law, in L. Foxhall/A.D.E. Lewis (eds), *Greek law in its political setting*, Oxford, 9-31.
- Thür, G., 2001: Neues über eine alte Inschrift (*IPArk* 8, *IG V* 2, 262; Mantinea um 460 v. Chr.), in V. Mitsopoulos-Leon (ed.), 207-212.
- Thür, G./H. Tauber, 1994: *Prozessrechtliche Inschriften der Griechischen Poleis. Arkadien*, Wien.
- Tomay, G., 2002: Ceramiche di tradizione achea della Sibaritide, in E. Greco (ed.), 331-355.
- Van Dommelen, P., 2002: Ambiguous matters. Colonialism and local identities in Punic Sardinia, in C. Lyons/J. Papadopoulos (eds), 121-147.
- Veit, U., 1989: Ethnic concepts in German prehistory. A case study on the relationship between cultural identity and archaeological objectivity, in S. Shennan (ed.), 33-56.
- Voyatzis, M., 1999: The role of temple building in consolidating Arkadian communities, in T. Heine Nielsen/J. Roy (eds), 130-168.
- Wachter, R., 2001: *Non-Attic Greek vase inscriptions*, Oxford.
- Williams, R., 1972: *The silver coinage of the Phokians*, London.
- Wiseman, J., 1976: *The land of the ancient Corinthians*, Göteborg.
- Yntema, D., 2000: Mental landscapes of colonization. The ancient written sources and the archaeology of early colonial Greek southeastern Italy, *Bulletin Antieke Beschaving* 75, 1-49.

The Ionians in the Archaic period. Shifting identities in a changing world

Jan Paul Crielaard

- 1 Introduction
- 2 Ethnonyms: self-definition at home and abroad
- 3 Language and dialect
- 4 Myths of common descent
- 5 Common way of life
- 6 Cult: sanctuaries as foci of local and supra-local identities
- 7 Summary and concluding remarks

Abbreviations

References

I INTRODUCTION

In his history of the Persian wars of the 6th and 5th centuries BC, Herodotos of Halikarnassos provides some interesting details about the Ionians of the Dodekapolis, the twelve cities on the west coast of Asia Minor and the offshore islands of Samos and Chios (fig. 1).¹ The Ionians of the Dodekapolis were proud of the name ‘Ionian’, Herodotos tells us, and ‘marked their pride by building a temple for their own use which they called the Panionion, and by excluding from it all the other Ionians’. In revolt against Persian domination, the twelve cities united in a Panionian *koinon* or ‘league’.²

Herodotos suggests that the Ionians of the Dodekapolis possessed some kind of collective identity, which was expressed in religion and cult, and enhanced solidarity in military matters. For previous generations of scholars, there was little need to discuss on what this collective identity was based and how it had come into being. It seemed clear that being Ionian was a matter of ethnic affiliation.³ Such categories as Ionians and Dorians and their subdivisions – *phylai* or ‘tribes’ in English translation – were considered as primordial ethnic entities that were part of a primitive social substructure that had managed to live

¹ The main body of the present paper was written in 2002; a few additions to text and bibliography were made in the Fall of 2008. I wish to thank the participants in the 2001 conference for their comments during the discussions, as well as Filiz Songu, Jonathan Hall and Hans van Wees for reading earlier drafts of this paper, Bert Brouwenstijn for the art work, and Willemijn van Dijk for her help with preparing fig. 2. For quotations from

Archaic lyric poetry, I have used the translation by M.L. West (1993).

² Hdt. 1.141-143 (quote from 143.3); further 1.147-148, 151-152, 170; 5.108-109; 6.7.

³ Herodotos himself uses at least twice kinship terms to describe the collective identity of the Ionians (1.56: *genos*; 1.143: *ethnos*).



Fig. 1. Map of Ionia. Placenames indicated by open circles are member states of the Ionian Dodekapolis

on in historical times.⁴ This way of looking at ethnicity meant that myths about common origins and ethnic identity found in ancient literary sources were believed to contain a kernel of historical truth.⁵ The role that was attributed to archaeology was mainly to furnish evidence that could give credence to the ancient tradition.⁶

Over the last decades, sociologists and anthropologists alike have critically re-examined these kinds of ideas about ethnicity. Their insights have also reached the field of archaeology, not in the least thanks to the work of Stephen Shennan, Siân Jones, Jonathan Hall and others,⁷ who have put ethnicity back

⁴ See e.g. Sakellariou 1958, 47, 255 (Mycenaean origins); Roebuck 1955, 31–36; also 1961, 496 f., 504 f. (Panionian league going back to at least the Ionian migration of the 11th – 9th centuries).

⁵ E.g. Roebuck 1961, 496.

⁶ See e.g. Hanfmann 1948; Cook 1961, 12–14; Huxley 1966, 26; Emlyn-Jones 1980, 25; also remarks in Simon 1997, 140 f.; Cook/Nicholls 1998, 56, 71; I.S. Lemos

2002, 199 f., with note 65; Ayaçlar 2004, 30.

⁷ Shennan 1989; S. Jones 1997; J. Hall 1997; 2002 (67–71: on the Ionians of Asia Minor); Malkin 2001. A distinct, but largely parallel interest in the processual nature of ethnogenesis and in the construction of identities has developed in the German-speaking academic world, see e.g. Ulf 1996a; Brather 2000.

on the archaeological agenda. There are a number of relevant insights we may share with these authors. Ethnicity, they stress, is not of all times. It is a cultural construct, not a biological fact. Ethnicity is only one of many possible forms of group identity. Like other kinds of cultural identity, it is a situational construct. If ethnic consciousness exists, it is not always given prominence but given expression in specific situations. Furthermore, ethnic identity is not a static, ascribed aspect of people's lives, but is contested, negotiable and subject to change.⁸ This means that ethnic and other identities can be expected to be in a state of flux, especially in situations of significant social or political change or tension.⁹ As ethnic identities change, so too do boundaries between ethnic groups.

With these insights in mind, we may return to the passage in Herodotos just referred to. We may re-examine a number of basic questions raised by this passage, such as on what exactly Ionian identity was based, when and why it came into existence, and how it developed over time. Furthermore, we may discuss the circumstances that fostered the construction of Ionian identity and the contexts in which Ionians and others chose to express ethnic or other forms of self-consciousness. The realization that ethnicity is not so much a fixed, biological fact as a mental construct that is likely to change over time, draws our attention to group strategies of inclusion and exclusion, and to the ways in which those who were excluded responded to this. As we saw from Herodotos' description, the Ionians of Asia Minor used exclusive religious gatherings to set themselves apart from their Ionian 'kinsmen' and the other Greeks. A little further on, Herodotos adds that the Ionians of Asia Minor pretended to be 'more truly Ionian, or better born than the other Ionians'.¹⁰ What this statement implies is that ethnic identity could even be a matter of rivalry between competing groups. Herodotos himself argues fiercely against the claims of the Ionians that belonged to the Dodekapolis. This serves to remind us that our source of information is not a distant observer, but a participant in a dispute about contested identities. The background to this dispute and, more generally, the circumstances under which ethnic claims were rhetorically mobilized are also issues that we have to take into account.

In contrast to some previous studies, the approach to literary evidence chosen here will be not to use the ancient tradition to piece together the earlier history of the Ionians and their institutions, or to reconstruct certain 'historical' events, such as the supposed Ionian migration. Instead, our focus will be on what Eric Hobsbawm calls the 'invention of tradition' and what Hans-Joachim Gehrke labels '*geglaubte*' or '*intentionale Geschichte*' to denote the mechanism of creating a mythical past as part of a process of ethnogenesis.¹¹ Literary sources will be used primarily to reconstruct what self-images Ionians sought to create, how they saw themselves in the present and past, and how they were perceived by others. I will try to introduce a temporal dimension and consider how these perceptions changed over the course of time. Archaeology, I believe, can make an important contribution to this type of approach. First of all, archaeological data give us an opportunity to check up on written sources in order to estimate when and how traditions were invented. But an even more significant potential contribution of archaeology concerns the study of material culture and its role in shaping identities. Identities were created not only by means of 'words' but also with the help of 'things'¹² or 'actions' that possibly left traces in the archaeological record. We will see that increasingly intensive communications with entities that were culturally or ethnically different demanded some kind of response. We will also see that material culture was used

⁸ Barth 1969.

⁹ See e.g. contributions in De Vos/Romanucci-Ross 1975; Roussel (1976) stresses this point with respect to tribal subdivisions in ancient Greece.

¹⁰ Hdt. 1.146. Herodotos makes an effort to stress the disunity and internal disunion of the Ionians, see esp. 1.141-143, with Alty 1982, 11 f. This is an example of

an anti-Ionian bias current in the 5th century after the Persian wars, see Roebuck 1953, 15 note 7, and below.

¹¹ Hobsbawm 1983; Gehrke 1994, esp. 247; idem, this volume.

¹² Cf. I. Morris 2000.



Fig. 2. Map of the Aegean and central Mediterranean showing place names mentioned in the text.

in an active manner to formulate responses – responses that varied from opposition on the one hand to integration and accommodation on the other.

In this paper, the term ‘Ionia’ is reserved for the coastal area between the rivers Hermos and Maian-dros, and the off-coast islands of Samos and Chios. To distinguish this region’s inhabitants from the other Ionians, I mostly will refer to them as ‘East Ionians’. The period I will focus on covers the late 8th to the early 5th century BC. Our information about this era comes from a rich variety of literary, epigraphic and archaeological sources. The period under discussion saw the formation of the polis and, in its wake, the articulation of local aristocracies or oligarchies, and the rise of *tyrannoi*.¹³ The Ionian poleis of the Archaic period can be reckoned among the leading centres of the Hellenic world (fig. 2) – culturally, intellectually and, to a certain extent, politically. What makes the East Ionians an interesting case for the study of identity in antiquity is their proximity to and interaction with other entities. These were, first of all, their neighbours – Dorian and Aiolian Greeks, and non-Greek Lydians and Karians.¹⁴ In the second place, the Ionians and, indeed, the East Greeks in general, were in frequent contact with more distant ‘others’ by means of a wide range of overseas activities. They were active as traders and settlers all around the Mediterranean and the Black Sea, and served as mercenaries in the armies of the great kings of Egypt and the Near East.¹⁵

Also of interest in this connection is that during the Archaic period the Ionian cities of Asia Minor were exposed to a number of more powerful entities. Some of the Ionian cities came under almost constant attack from the Lydian kings of the Mermnad dynasty (c. 675 – 546)¹⁶ and were even nominally

¹³ Cook 1982b, 199–201.

¹⁴ Mazzarino (1947) in particular has emphasized that interactions with non-Greek neighbours must have stimulated Ionian self-awareness.

¹⁵ Trade and colonization: Roebuck 1959; Ehrhardt 1983;

Gras 2000; Lombardo/Frisone 2000; Tsetskhladze 2002. Mercenaries: see below.

¹⁶ *Mimn. fr.* 13–13a [West], with Hdt. 1.14–22, 25; Polyain. *Strat.* 7.2.2; Paus. 4.21.5; 9.29.4. Cobet 1997, 256–258 for further references.

subjected by king Kroisos,¹⁷ although the new political constellation did hardly affect the prosperity or military might of the Ionian cities.¹⁸ When the Persians defeated Kroisos, the mainland cities came under Persian rule during the 540s and most of them were governed by pro-Persian tyrants.¹⁹ Many Ionian and other East Greek cities joined in the revolt in 500/499, which the Persians put down in 494.²⁰ In 490 and 480/479 the Persians were defeated twice in mainland Greece, after which the Athenians started to carve out an ‘Ionian’ maritime empire in the Aegean under the guise of an anti-Persian confederacy.²¹ According to some modern scholars, it is especially interaction with empires or expanding states that makes smaller socio-political units more aware of their ethnic identity. The underlying idea is that empires and expanding states favour the establishment of more fixed geographical boundaries between groups of peoples, and that these boundaries foster ethnic self-consciousness.²² One of the matters we will examine in this paper is the effect Lydian and Persian imperial policy had on the construction of Ionian ethnic identity.

2 ETHNONYMS: SELF-DEFINITION AT HOME AND ABROAD

We will start with a brief overview of the occurrence of the terms ‘Ionians’ and ‘Ionia’ in the early Greek literary record. The oldest attestations date to the Late Bronze Age. The ethnicon ‘Ionian’ occurs as *i-ja-wo-ne* on two fragmentary Linear B tablets from Knossos. One of these comes from a context that dates possibly to c. 1400 BC. The tablets presumably list detachments of warriors and their original ethnic designations.²³ Our earliest literary sources for the Iron Age are the Homeric epics. Homer’s poetry stands at the end of a long oral tradition, but – as most scholars see it – the *Iliad* and *Odyssey* were composed and possibly also put down in writing in the second half of the 8th or the first half of the 7th century BC.²⁴ In the Homeric poems Ionians are mentioned only once, in the archaizing form *Iaones*, accompanied by the epithet ‘with their trailing garments’. The context is a battle scene that involves contingents from a number of neighbouring regions. The regions mentioned make clear that the Ionians are West Ionians, i.e. Athenians or, less likely, Euboians.²⁵ The context further indicates that the term *Iaones* does not refer to a supra-regional entity, but to some kind of smaller, regional entity. The *Homeric Hymn to Apollo*, which

¹⁷ Hdt. 1.6.2, 26–28, 141. However, the Lydian kings established with the Ionian islanders friendship relations (ξενίη; 1.27.5), and made the Milesians friends and allies (ξείνους και συμμάχους; 1.22.4, 141.4, with Balcer 1984, 14; Tausend 1992, 95 f.).

¹⁸ See e.g. Anacreon fr. 146 [Page]; Hdt. 3.39.3–4, 122.2 (Samos); 5.28 (Miletos); Thouk. 1.13–14 (Samos, Phokaia and Ionians in general).

¹⁹ Hdt. 1.141–170 (but not Miletos [1.141.4, 169] and the islands [1.155–160, 169.2]); 3.89–90, 120; 4.89 ff., with Georges 2000.

²⁰ Murray 1988.

²¹ Emlyn-Jones 1980, 165–167.

²² Whitehead 1992; also De Vos 1995, 16.

²³ Driessen 1998/1999, 84 f. See also below, note 31. O. Carruba (1995, 13–21) argues, not entirely convincingly, that the terms *Iaones* and *Ahhiyawa* are linguistically connected.

²⁴ References in Crielaard 1995, 201 note 2. In my opinion, the Homeric poems have many links with the Hellenic world of the early 7th century, see Crielaard 1995; 2002; also van Wees 2002.

²⁵ *Il.* 13.685 ff.: ἰάονες ἔλκεχίτωνες. The ‘chosen Athenian men’ mentioned in 689 seem to be the same as the *Iaones* in 685, but W. Burkert (1984, 17 f.) argues that the latter were Euboians. However, in the *Iliad* (2.536; 4.464) inhabitants of Euboia are known as Abantes (see also below, note 80). It is possible that the mention of *Iaones* in this passage is an example of deliberate archaization: the poet knew that Ionians had migrated to Asia Minor only after the Trojan war. Another possibility is that the Athenians already identified themselves as Ionians (cf. Strabo 9.1.5). According to F. Prinz (1979, 364 f.; also Ulf 1996b, 251), on the other hand, *Il.* 13.685 ff. is a later interpolation by which Athenians tried to usurp the name ‘Ionian’.

is dated to the 7th or, more plausibly, the latter half of the 6th century,²⁶ also mentions ‘Ionians with their trailing garments’,²⁷ who gather together on the island of Delos for their religious celebrations. They probably come from the neighbouring islands (the Kyklades, Euboia and, possibly, Attika) and the eastern Aegean (see further below: section 6). The earliest references to the term ‘Ionia’, finally, date to c. 600. In a fragmentary poem Sappho of Lesbos possibly speaks of ‘Ionia’s cities’.²⁸ It may be added that other sources usually refer to the central west coast of Anatolia as *Asië*, which seems to have been used for this part of the coastal region until it became applied more widely.²⁹ Solon, the Athenian statesman and poet who lived around 600 BC, claims in a political poem that Attika is ‘the eldest country of Ionia’. It is unknown what other regions outside Attika he had in mind, but not necessarily the domicile of the East Ionians. In antiquity there was a tradition that in early times ‘Ionia’ included Attika and Megaris, as well as Boiotia and different parts of the Peloponnese (including Achaia of later times).³⁰ It is, thus, possible that Solon intended to say that Attika was founded in the deep, pre-migratory past, and had been preeminent already in the times when Ionians had occupied a much larger part of Hellas.

With respect to ethnonyms and self-identification it is relevant also to consider how Ionians abroad were identified and identified themselves vis-à-vis non-Greeks. In Near Eastern documents in Akkadian, Hebrew and Aramaic we find references to *Yawnaya*, *Yawanaya*, *Yāwān* etc.³¹ Most specialists agree that these are transcriptions of the terms ‘Ionia’ and ‘Ionian(s)’, derived from the archaic form *Iaones* (< **Iawones*). Assyrian and Babylonian documents dating to the 7th and 6th centuries and references in the Old Testament give the impression that *Yaw(a)naya* or *Yāwān* were associated with the Aegean as well as with Cyprus and Cilicia.³² In still later times, when communications became more frequent and geographical knowledge more detailed, the terms were used for the Greeks in general.³³ Taking this broadening of terminology into consideration, it is especially relevant to look at the first attestations of the term. We may assume that the earliest Near Eastern encounters with the ‘original’ *Yaw(a)naya* were with Greeks who identified

²⁶ Janko 1982, 99–115, 200 (c. 660); West 1975, 169 (c. 570 – 547); Burkert 1979, 60 (c. 522, i.e. the Delian part).

²⁷ *Hom. Hymn Ap.* 146–147: ἑλκεχίτωνες ἰάονες.

²⁸ Sappho fr. 98.12 [Voigt]: ...ἰωνιασπολεῖς [... Another reconstruction is ‘[M]aonia’s cities’, instead of ‘[I]aonia’s cities’.

²⁹ *Il.* 2.461; *Archil.* fr. 227 [West]; *Mimn.* fr. 9.2 [West]; Simonides of Keos (c. 500 BC), *el.* 14.7 [West]; also *Hdt.* 1.146; 3.90.1; 4.45.3; *Strabo* 8.7.1; 13.4.8 (Asia=Maonia). Cf. Hippokrates *Aer.* 12. Designation may go back to Bronze Age, see S.P. Morris 2001, 135 f., with refs.

³⁰ Solon fr. 4a [West]: γαῖαν [I]αωνίης. Note that according to Herodotos, Ionians had been living not only in Achaia (1.145, 148; 7.94) and Attika (5.66.2), but also in Boiotia (5.58.2), the Argolid, Kynouria and, more generally, the Peloponnese (8.73.3; cf. Paus. 2.26.1–2; 7.4.2). According to *Strabo* (9.1.5; 10.1.3, 6), also in Euboia and Megaris; cf. 8.6.15, 7.1; 9.1.5: ‘Ionia and Ias’ (Ias may be partly overlapping with Ionia, cf. Piérart 1978; N.E. Jones 1987, 166).

³¹ Discussion of Akkadian texts: Braun 1982a, 1–3, 14–24; Brinkman 1989; Rollinger 2001; Kuhrt 2002. Possibly older still are references to *Yman* (‘Ionia?’) in texts from Late Bronze Age Ugarit, see Dietrich/Loretz 1998.

³² Assyrian and Babylonian sources: Brinkman 1989, 56–61 (Tarsisi=Tarsos?); Helm 1980, 161–166; Lanfranchi 2000. Three ‘Ionian’ artisans and traders in Babylonian texts who have non-Hellenic names may be inhabitants of western Asia Minor or Ionians from Cilicia (?). Old Testament: Ezek. 27.13, 19: Yawan trading bronze goods and slaves (see also Joel 3.6), mentioned together with Tubal (northern Cilicia) and Meshech (Phrygia). Ezekiel lived in the early 6th century, but it is possible that his ‘Lamentation for Tyre’ was based on material of an earlier date, see Liverani 1991, 65–72, 79; Elat 1991, 24. See further the ‘world genealogy’ in Gen. 10.1–4 (also 1. Chron. 1.5, 7): Rhodos referred to in connection with *Yāwān*; this was a 5th-century revision of a probably much earlier genealogy, see West 1985, 14. Isai. 66.19: *Yāwān* and ‘the distant islands’ could refer to the Aegean.

³³ See e.g. Daniel 8.21; 10.20; 11.2; Zech. 9.13. Cf. Latin term *Graeci* for ‘Greeks’ (=Graikoi, inhabitants of Epiros). See further Aeschylus’ *Persai* (178, 563) where, according to Near Eastern practice, *Iōnes* in the mouth of a Persian designates the Greeks in general.

themselves as ‘Ionians’. The earliest mention is in Assyrian texts dated between 735 and 705 BC, where *Yaw(a)naya* are said to have raided the Phoenician coast. They occur as a well-known entity that does not deserve further explanation, indicating that the Assyrians had encountered them before.³⁴ Who were these *Iaones*? Walter Burkert suggests that they were West Ionians from Euboea.³⁵ Archaeology may support this position. The distribution of imported Greek pottery – the only testimony we have for possible activities of Greeks in this period – indicates that Euboians were active in the eastern Mediterranean from the later 10th century onwards, with a peak in the second half of the 8th century. Possible imports from Ionian cities in Asia Minor, on the other hand, gain substance only after 700 BC.³⁶

Greek inscriptions found in Egypt provide testimony of how East Ionians and other East Greeks identified themselves abroad in the Archaic period. Probably during the Nubian expedition of Psammetichos II in 592/1³⁷ Greek and Karian mercenaries visited the ancient temple at Abu Simbel. On the legs of the colossal rock-cut statues they left a memorial inscription in a Doric dialect (but mainly in Ionian script), and some soldiers added their signature together with an ethnic/toponym. We encounter Pa[m]bis the Kolophonian, Elesibios (or: Hegebios?) the Teian and Telephos and Anaxanor of Ialysos (Rhodos).³⁸ In 6th-century inscriptions, graffiti and dipinti found in the Greek sanctuaries at Naukratis in the Egyptian Delta, East Greeks from Chios, Phokaia, Klazomenai, Teos, Mytilene and Rhodos present themselves in a similar fashion (i.e. first name + ethnic/toponym).³⁹ It has been suggested that names without ethnics at Abu Simbel and Naukratis belonged to second-generation Greek mercenaries and local residents.⁴⁰ However that may be, it is striking that in both cases there were individuals that identified themselves by their city of origin and did not refer to themselves by the generic ‘Ionian’, as one would perhaps expect in this situation and context. One possible conclusion is that Ionian identity was not yet strongly articulated. On the other hand, it cannot be ruled out that the above examples of self-identification were specifically aimed at fellow Greeks abroad. If so, this would underline that among the Greeks of the Archaic period polis identity was especially salient. By way of contrast, we may note that 6th-century dedicatory graffiti of East Ionians at Gravisca in Etruria mention neither toponyms nor patronyms.⁴¹

Lastly, we may refer to a palimpsest from Elephantine, Egypt, written in Aramaic. It recounts port duties collected from Ionian and Phoenician ships in 475 BC. Following the date of arrival, each Ionian ship is identified by the Greek name and patronymic of the captain/owner, followed by the word *γῠνῆ* (‘Ionian’). Some of the names and the mention of ‘Ionian’ (*γῠνῆ*) wine suggest that these traders were East Greeks.⁴² In this context, the generic ‘Ionian’ (=Greek) + patronymic was apparently sufficient.

³⁴ Brinkman 1989, 54–56; Haider 1996, 80 note 116; Lanfranchi 2000, 15–16; Rollinger 2001, 237–239; N. Luraghi 2006, 30–33.

³⁵ Burkert 1984, 17 f. Cf. N. Luraghi 2006, 34 f., 41 (Ionians from Euboea, the Kyklades and Asia Minor).

³⁶ Crielaard 1996, 343 Table IX.

³⁷ See Hdt. 2.161–163.

³⁸ Meiggs/Lewis 1969, 12 f.; Jeffery 1990, 314, 340, 344 (38, 56, 58), 355 f., 358 (4a–b, 48), with Haider 1996, 104–109; Pernigotti 1999, 53–74; Vittmann 2003, 200–202. The main inscription also mentions ἀλλόλοσος [ἀλλόλοσσος], ‘those of foreign speech’ (cf. Hdt. 2.154: ἀλλόλωσσοι) led by Potasimto; these may have been Karians (Ray 1990, 79), although in Egyptian inscriptions Potasimto is styled ‘general of the Haunebut’, a term in this period often referring to Greeks (Vittmann 2003, 201). Karian graffiti:

Vittmann 2003, 161 f.

³⁹ Jeffery 1990, 340 f., 344 f. (59, 63–64, 68), 361 (4); also H. Prinz 1908, 118; Möller 2000, 166–177; Wachter 2001, 214–219, esp. 215, 218 (G, K).

⁴⁰ Jeffery 1976, 196; 1990, 355; Boardman 1980, 115 f.; Ehrhardt 1985, 142; Haider 1996, 108 f.; Pernigotti 1999, 62 f.; Vittmann 2003, 202 (also 203, 227 ff.). However, in later graffiti from Egyptian Abydos (c. 500 – 450?) such Greeks identified themselves as Μεμφίτης (‘of Memphis’) or Δαφναίτες (‘of Daphnai’); see Jeffery 1990, 355, 358 f. (51, 54); also Möller 2000, 189: *Ναυκρατίτης* (‘Naukratite’, late 5th century).

⁴¹ Cf. Torelli 1977, 404–408; 1982, 309–321; also Ehrhardt 1985.

⁴² Yardeni 1993, 67–78; only a few of the personal names are preserved: *ibid.*, 69 Table 2.

If we summarize this section, we may say that already during the Bronze Age the term ‘Ionians’ may have existed as an ethnonym. We have noted that the early testimony for the historical period (later 8th to early 6th centuries) – however sparse – tends to place the ‘Ionians’ on the west side of the Aegean (Euboia, Attika) and on the Aegean islands (basically the Kyklades). The name ‘Ionians’ may have applied also to inhabitants of the eastern Aegean, but our sources are less explicit about this.⁴³ The epigraphic evidence from Egypt and the Near East makes it clear that, after the early attestations of probably Euboian *Yaw(a)naya / Iaones*, Ionian Greeks identified themselves by means of place name or patronym. This could be taken as an indication that local or polis identity⁴⁴ was important – apparently more important than other categories, such as ‘Ionian’ or ‘Greek’.

Notwithstanding that, we will try to identify in which ways Ionian identity found expression, and how this changed over the course of time. We start our query from a fictional speech in Herodotos’ *Histories*. In this speech four characteristics are enumerated that Greeks of the 5th century were supposed to hold in common. These were common descent, common language, shared religious practices and a common way of life.⁴⁵ Although it is not clear to what extent these characteristics were generally accepted as criteria of group self-recognition, we have here a useful set of marks of ethnic self-definition that will serve in the following sections (3 – 6) as a guideline to discuss possible aspects of Ionian identity.

3 LANGUAGE AND DIALECT

Language and dialect are a first, potentially distinctive feature that could have helped to shape Ionian identity.⁴⁶ The local Greek dialects of the historical period can be classified within four major dialect groups. The distribution of three of these dialect groups was characterized by a division into zones that stretched west – east across the Aegean (fig. 3). Ionian dialects were spoken in Attika, Euboia and most of the Kyklades (together sometimes designated as ‘West Ionian’ and ‘Central Ionian’), and on Samos, Chios and the central coastline of Asia Minor (so-called East Ionian). Dorian – one of the Western-Greek dialects – was spoken to the south of the Ionian dialect zone, and to the north it was bordered by Aiolian-speaking entities.⁴⁷ Local scripts to some extent followed this division: the East Ionians used a common alphabet that was different from that of the West Ionians of Attika and Euboia; at the same time, this alphabet was distinct from the script used by their Dorian and Aiolian neighbours.⁴⁸

By the 3rd century BC and possibly even earlier, ancient authors tended to equate dialect with *genos*.⁴⁹ Consequently, it was felt that the major Greek dialects overlapped with the traditional ethnic divisions. However, it is far from certain whether in the 8th to 6th centuries the geographical distribution of individual dialect groups was the same or was as sharply defined as in, say, the 5th century.⁵⁰ In fact, it is

⁴³ *Contra* Cassola 1957, 246–256; F. Prinz 1979, 314–376. Both authors believe that the ethnikon ‘Ionian’ originated in Asia Minor.

⁴⁴ In this paper, I use the terms local identity and polis identity alternately as largely overlapping categories.

⁴⁵ Hdt. 8.144.2: αὐτίς δὲ τὸ Ἑλληνικόν, ἐὼν ὁμαιμόν τε καὶ ὁμόγλωσσον, καὶ θεῶν ἰδρύματά τε κοινὰ καὶ θυσίαι ἡθεᾶ τε ὁμότροπα, with useful discussions in Coleman 1997, 177 f.; Hall 1997, 44 f.; Thomas 2001.

⁴⁶ In principle, group identity can even be maintained by minor differences in speech patterns, such as local or regional dialects; see e.g. De Vos 1995, 23. For a more

general discussion of Greek dialects and ethnicity, see J. Hall 1997, esp. 170–181; 2002, 111–117.

⁴⁷ See e.g. Bartoněk 1979.

⁴⁸ Jeffery 1990, 326. Note that Herodotos (5.58–59) distinguishes Ionian script.

⁴⁹ Kearns 1992, 5.

⁵⁰ Huxley (1966, 34), for one, argues that during the Dark Ages the line between the Aiolian and Ionian dialects was further south than in historical times. Bartoněk (1979, 124) stresses the strong influences of Ionian spoken in Asia Minor on the Lesbian dialect. See further J. Hall 1997, 166, 170.

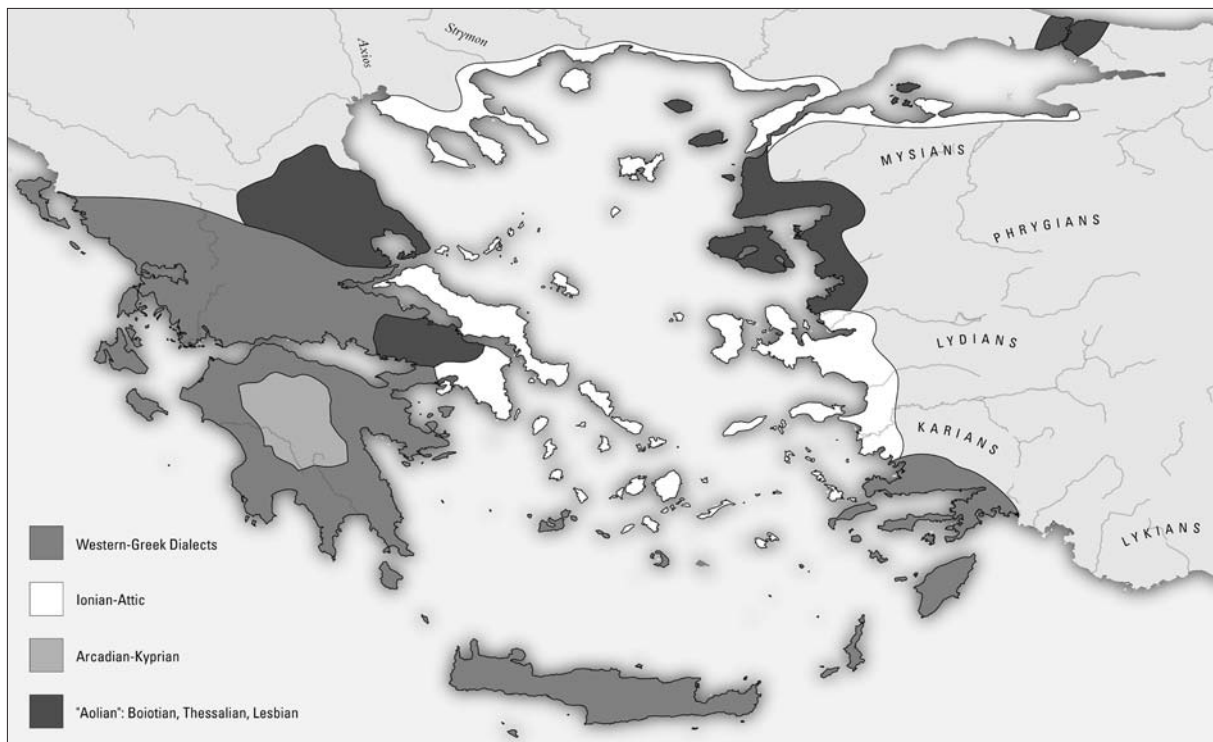

Fig. 3. Map of the Aegean showing the distribution of Greek dialect groups.

questionable whether the regions where these different dialects were spoken during the Archaic period were separated by hard, impermeable boundaries. For this earlier period we have evidence that the linguistic or ethnic situation was in some kind of flux. Halikarnassos, for example, which regarded itself as a Dorian settlement and member of the original Hexapolis of the Dorians,⁵¹ was essentially a Karian-ruled place whose inhabitants frequently bore Karian names but employed – at least in the 5th century – the East Ionian dialect and script.⁵² What is also important to remember is that dialect was sometimes used outside the context of ethnic affiliation. Ionian, for one, was the conventional dialect used for specific poetical, philosophical and literary genres, independent of the origin of the author. Thus, we find that even for a ‘typically’ Dorian poet such as Tyrtaios there was nothing unusual about composing elegies in epic language that was a composite form of Ionian. This ability of dialect switching may have tempered feelings of regional differences. It will have contributed rather to an awareness of the ‘Greekness’ that all dialects had in common.⁵³

‘Tongue differs from tongue among the men from many lands,’ Homer says in the *Iliad* about Troia’s Anatolian allies.⁵⁴ Indeed, a variety of non-Greek peoples living in the interior of Asia Minor and in some coastal areas spoke Karian, Lydian, Phrygian and Lykian. Lydian and Lykian descended from the Indo-European ‘Anatolian’ languages of the Bronze Age and this is probably also true for the language of the Karians, although for Homer their speech was *barbarophonos*.⁵⁵ Although compared to the above dialectal differences, the linguistic boundaries between Greek and non-Greek speaking populations will have been more solid, they were certainly not impermeable. A first indication of this is the use of script.

⁵¹ Later Pentapolis, see Hdt 1.144.2; also 2.178; 7.99.3.

⁵² Bean/Cook 1955, 96; Jeffery 1976, 195; 1990, 353.

⁵³ A point made by Morpurgo Davies 2002, 157 f., 165.

⁵⁴ *Il.* 2.804-805; see also 4.437-438, with Ross 2005.

⁵⁵ *Il.* 2.867, with Georges 1994, 14 f. for comments on this passage. Cf. Prodikos’ qualification of Pittakos’ Lesbian dialect in Plato, *Protagoras* 341c. Karian language: S. Luraghi 1998; Renfrew 1998, 252 f.; Vittmann 2003, 179.

From the 8th century onwards the Greek and non-Greek speaking populations of western Anatolia developed a writing system that was closely interrelated (the so-called ‘Greek’ alphabet).⁵⁶ But there are more compelling indications to think that linguistic differences did not create ‘hard’ ethnic borderlines. Smyrna, for example, has yielded epigraphic evidence to suggest that during the 8th century and later, Karian and Lydian were used next to Greek, which could indicate that it accommodated a multilingual population on a temporal or permanent basis.⁵⁷ Also the satiric poetry of Hipponax, who lived in Ephesos and Klazomenai during the late 6th century, shows that the poet and – presumably – his audience had quite a firm grasp of Lydian and even Phrygian. The many loanwords⁵⁸ create the impression that the demotic vernacular current in the East Greek cities was not pure Greek. Hipponax’ poetry,⁵⁹ combined with evidence from the Homeric *Hymn to Aphrodite*,⁶⁰ even suggest that bilingualism may not have been uncommon in western Asia Minor.

Herodotos tells us that among the East Ionians four regional sub-dialects (*charaktēres glōssēs*) could be distinguished, but he fails to specify on what these differences were based.⁶¹ Although phonological differences are not very obvious in the epigraphic corpus, it is possible that the extant inscriptions render official Ionian, whereas dialectal variation would have been used in colloquial speech. There are indications that the sub-dialects Herodotos alludes to were tinged with a flavour of Karian, Lydian and Aiolian, respectively.⁶² Analysis of the available linguistic evidence leads one modern scholar to the conclusion that a ‘Western Anatolian *Sprachbund*’ existed among a number of cities in Ionia and Lydia.⁶³

Summing up, although linguistic and dialectal differences existed during the late 8th to early 5th centuries, they do not seem to have created ‘hard’ linguistic or ethnic borderlines. We may end this section with a reference to a fragment of another political poem by Solon, in which he says he has brought back the poor peasants of Athens, who had been sold abroad as slaves – ‘their speech no longer Attic’.⁶⁴ This passage is of interest for two reasons. One is that it shows that in Athens at this time we do find pronounced sentiments about the identity of autochthonous inhabitants, the purity of their mother tongue and their link with what Solon calls Athens’ ‘god-founded’ land.⁶⁵ The other interesting aspect is that the native mother tongue is already identified as ‘Attic’ (*attikē*), not as Ionian.

4 MYTHS OF COMMON DESCENT

IONIANS AND DORIANS

The literary sources of the Archaic period provide testimony of a certain interest in ethnic identity. Awareness of ethnic differences and communalities is apparent in so-called theogonic and genealogical poetry.⁶⁶ Hesiod’s *Theogoneia* of the early 7th century presents a first genealogical catalogue of the fami-

⁵⁶ Diffused either from west to east (see references in Boardman 1980, 88 note 228, 98 note 260) or east to west (e.g. Röllig 1992). However this may be, elements adopted from the Phrygian or Karian alphabet are found in some early East Greek inscriptions; see Meiggs/Lewis 1969, 62.

⁵⁷ Gusmani 1975; also Jeffery 1964, 47 f. Cf. Weiß 2006, 282 f.: early 6th-c. Lydian inscription from Miletos; Ehrhardt 2006, 84-86: Karian names in Milesia and Samos.

⁵⁸ See Masson 1962, 16, 31 f.; Kearns 1992, 355, 373.

⁵⁹ Esp. Hipponax fr. 92.1-2 [West].

⁶⁰ *Hom. hymn Aphr.* 113-116.

⁶¹ Hdt. 1.142.3-4.

⁶² Jeffery 1990, 327; Kearns 1992, 8, 368-374.

⁶³ Kearns 1992, 368.

⁶⁴ Solon fr. 36.10 [West].

⁶⁵ Solon fr. 36.7 [West].

⁶⁶ Special place of genealogies: see *Theog.* 44-52; also Hdt. 2.53. Among the pre-5th century genealogical poets from Ionia is Asios, whose interest was his native island Samos, see Paus. 7.4.1 (cf. Athen. 12.525e-f), with West 1985, 4 f.

lies of the gods. Especially relevant in this connection is the Hesiodic *Catalogue of Women*, a posthumous continuation of the *Theogoneia*. It has been fragmentarily preserved, but originally it must have comprised a comprehensive genealogical catalogue of heroes and heroines, bringing together myths concerning the origins of various local populations living in mainland Greece. One of the first genealogies mentioned is that of Hellen, the *Urvater* of the Hellēnes: ‘From Hellen the war-loving king sprang Dōros and Xouthos and Aiolos who fights from the chariot’.⁶⁷ Dōros and Aiolos were the progenitors of the Dorians and Aiolians, respectively. The non-eponymous Xouthos was the father of Iōn (Iaon) and Achaios, who in their turn were the eponymous ancestors of the Ionians and Achaioi (Achaean). The *Catalogue* in its final form can be dated to the 6th century, but it is possible that it evolved by stages from earlier, local or regional genealogies.⁶⁸ Martin West suggests that the passage about Hellen’s offspring is an example of a ‘regional’ genealogy, perhaps going back to the 8th or even 9th century. Originally it may have related to groups of this name living in central mainland Greece. As for the descendants of Xouthos and Iōn, they occupy a marginal place in this genealogy. This can be taken to indicate that they were localized in what from a central mainland perspective was the periphery of the central Greek world. The Ionians of this original genealogy are, then, possibly to be identified with the Ionian inhabitants of Euboa.⁶⁹ West suggests that only at a much later stage – possibly in the final, encyclopaedic version of the 6th century – the genealogies of the Ionians, Dorians, Aiolians and Achaians were extended and elaborated in such a way that they included large parts of the central and southern Greek mainland, including Attika and the Peloponnese.⁷⁰ Christoph Ulf, on the other hand, argues that the myth of Hellen’s offspring had no earlier roots, but was a relatively late construct meant to explain the coexistence of three intra-Hellenic subgroups. Given the fact that the presence of Aiolians, Ionians and Dorians was apparently especially salient in Asia Minor, this is also the region where Ulf locates the origin of these ethnic categories as well as the myth of Hellen.⁷¹

The myth of Xouthos and Iōn shows that the Ionians were an ethnic entity in the sense that their consanguinity was traced back to an eponymic *Urvater*. At the same time, the lack of detail in this story gives the impression that in the 6th century a specific Ionian mythology and hence a well-defined Ionian ethnic identity had not (or not yet) fully crystallized. This idea we will try to elaborate by means of comparing information about the Ionians with what we know from similar sources about the Dorians – the other important ethnic subgroup of Archaic and Classical Greece.

The work of the Spartan poet Tyrtaios, who lived during the late 7th century, contains some of the earliest references to the charter myth of the Dorians. In one of his elegies, he mentions the three Dorian tribes: ‘Pamphyloi, Hylleis and Dymanes, each distinct’.⁷² Interestingly, the broader context of the poem suggests that the ethnic subdivision also embodied a military subdivision. In another poem, Tyrtaios refers to the invasion and conquest of the Peloponnese by Herakleidai and Dorians:

⁶⁷ *Cat. of Women* fr. 9 [Merkelbach/West], with West 1985, 36, 57.

⁶⁸ West 1985, 128, 130–136, 164; also J. Hall 1997, 42–44, 48–50; 2002, 238 f.

⁶⁹ Note on the other hand that the Euboians probably had a place within the genealogy of the *Catalogue* in the person of such figures as Arethousa, Chalkodon and Elephenor (cf. West 1985, 42, 99; also 145 f.).

⁷⁰ West 1985, 57–59, 138–144. In its definitive form, the poem became something approaching a compendium account of the nation’s legendary past. As West remarks

(p. 166) ‘... the initial position of the Deukalionids creates the illusion that Hellen with his sons Dōros, Xouthos, and Aiolos stand over the whole complex, as if they were the ancestors of the entire nation’.

⁷¹ Ulf 1996b, esp. 249–252, 264–271. A weak point in this hypothesis, however, is that the fourth subgroup, the Achaians, did not have a place in Asia Minor.

⁷² Tyrtaios fr. 19 [West]. Hylleis descended from Herakles’ son Hyllos and should, strictly speaking, be a Heraklid. The other two descended from sons of Aigimios, son of Dōros, the mythical ancestor of the Dorians.

*Zeus gave the sons of Herakles this state (polis).
Under their lead we left windswept Erineos
and came to Pelops' broad sea-circled land.*⁷³

Here we have an early attestation of two elements that are typical of the ancient Greek *Ursprungsmythos*. One is that of blood ties going back to a common (eponymous) ancestor. The other is that of a shared non-indigenous, migratory past and association with a specific territory. The latter contributed to the sense of forming a kind of super-family and helped to define the Self in opposition to the (indigenous) Other.

Somewhat earlier in date are two possible references to Dorians that we encounter in the Homeric epics. In the *Odyssey*, Krete is described as an island of linguistically and ethnically mixed composition. Among its inhabitants are the 'three-divided Dorians'.⁷⁴ In the *Iliad*'s 'Catalogue of Ships', the inhabitants of Rhodos are likewise said to be 'ordered in triple division' and to 'have settled there in triple division by tribes'.⁷⁵ The latter reference to three *phylai* can be taken to refer to the Dorian origin of the Rhodians.⁷⁶ What is more, Tlepolemos – the leader of the Rhodian contingent – traces his pedigree back to the mythical hero Herakles, as do his peers from other Dodekanesian islands.⁷⁷ It may be evident that these passages contain a number of elements that betray ethnic consciousness, although it should be acknowledged that there is discussion about the precise interpretation of these passages.⁷⁸ Even if we handle the evidence with utmost care, we are permitted, I think, to observe that Homer is apparently acquainted with migrant Dorians in Krete and, possibly, the Dodekanese, and with local elites on some of the Dodekanesian islands that thought of themselves as Herakleidai. These island communities in the southern Aegean had in common that they were internally divided into three subgroups, which in at least one instance are identified as kinship and descent groups. What knitted some of these communities together was a collective identity based on the belief in a common Dorian origin. The Dorians of Krete are described as living side by side with, inter alia, Eteokretans ('true Kretans'), which shows that they constituted a regional entity of newcomers differentiated from the indigenous Kretans. This in its turn implies two things: firstly, that the Dorians shared a belief in a common migratory past, and, secondly, that these Dorians must have had kinsmen in one or more regions outside Krete. In other words, in the epics the Dorians are presented as a regional as well as a supra-regional ethnic entity. If we are willing to accept a slightly less cautious interpretation, we may envisage kinsmen of the Kretan Dorians living in the Dodekanese. If we consider the foundation myth of Rhodos rendered in the *Iliad*, the most economic interpretation still is that this story is a variation of, or is modelled on, the story of the conquest of the Peloponnese by the Dorian tribes, led by Heraklid kings.⁷⁹

⁷³ Tyrtaios fr. 2 [West]. See also fr. 11.1 [West]: Spartans (or, as Jonathan Hall [2007, 46] suggests, the more noble among them) are of the 'lineage (*genos*) of undefeated Herakles'. Cf. later sources: Simonides, *el.* 13 [West]; Pindar *Pyth.* 1.61–66; 5.69–72; *Isth.* 9.2–3, also Hdt. 1.56. For a different interpretation of these fragments, see Ulf 1996b, 256–260, 264 f.

⁷⁴ *Od.* 19.177: Δωριέες τε τριχάϊκες.

⁷⁵ *Il.* 2.655: διὰ τριχὰ κοσμηθέντες; 668: τριχθὰ δὲ ῥικηθεν καταφυλάδον. See further *Cat. of Women* fr. 233 [Merkelbach/West]: τρισσὴν γαίαν; West (1985, 59, 114) assumes that this refers to the establishment of the three Dorian kingdoms in the Peloponnese.

⁷⁶ Kinship terminology or terms related to that are rare in the Homeric epics; cf. *Il.* 2.362–363 (κατὰ φύλα ['tribes'],

κατὰ φρήτρας ['brotherhoods']), 840 (φύλα), although here these terms are used in a military or even political sense (Kirk 1985, 154); cf. 9.362–363. On these and other possible kinship groups in early Greece, see Gehrke 2000.

⁷⁷ *Il.* 2.653, 658–660, 666, 676–679; 5.638–639. Cf. *Cat. of Women* fr. 232 [Merkelbach/West]; Pindar, *Ol.* 7.27–29.

⁷⁸ See Kirk 1985, 225 f., and Russo *et al.* 1992, 84 f., and different readings by Roussel 1976, 224, and Ulf 1996b, 251 f., 271–273.

⁷⁹ At the same time, the story also contains elements typical of foundation stories known from colonies during the historical period, see esp. *Il.* 2.661–670. Comparable migration stories in *Od.* 6.9 ff. (Phaiakians) and *Il.* 6.150–211 (Lykian elite).

This would then suggest that Homer was even familiar with a supra-regional *Ursprungsmythos* that tied the Dorians together as invaders who had left their common homeland and, as a result of conquest and mass migration, had settled elsewhere. The Herakleidai, as leaders of this migration, were an essential element in this myth. With respect to these Herakleidai, we may observe that within communities that identified themselves as Dorian, local elites set themselves apart from the rest of the population, claiming privileged descent from the ‘original’ Heraklid rulers.

Let us now go back to the Ionians. As we saw earlier, the Ionians are virtually absent in the Homeric epics. What is more, the epics are rather consistent in *not* referring to regions and places that in historical times were inhabited by Ionians. This applies to a certain extent to Athens and Euboeia⁸⁰ and even more to the Kyklades and the islands off the coast of Asia Minor, such as Naxos, Paros, Samos and Chios.⁸¹ In fact, hardly any ethnic entities are mentioned as living on the west coast of Asia Minor south of the Troad and north of Lykia, except for Karians in the region of Miletos and Mykale.⁸²

The near absence in the Homeric epics of Ionians and, especially, East Ionians is conspicuous for more than one reason. Although the *Iliad* and *Odyssey* are truly pan-Hellenic poems, they are essentially an Ionian achievement. Something similar relates to the epic language that the poet uses: it is an artificial language, but the (East) Ionian and, to a lesser degree, Aeolian elements in it are dominant.⁸³ Moreover, later sources record the tradition that the poet of the *Iliad* and *Odyssey* lived in one of the main Ionian cities of East Greece (Chios, Smyrna, Erythrai etc.⁸⁴). The poet’s Ionian background can be detected also in the poems themselves: ‘The *Iliad*,’ says Martin West, ‘shows a knowledge of Asia Minor, from the Hellespont to the Cayster [Kaystros], that strongly suggests that its author lived somewhere between those limits.’⁸⁵

The omission of Ionians and their habitat from the epics requires an explanation. According to a widely accepted view, it is a case of deliberate archaizing. The Ionians and Aeolians of historical times believed that their forebears had migrated to Asia Minor after the Trojan war. In order to create a credible account of this Heroic Era (what we call the Bronze Age), the epic poet had to avoid any hint of the Ionians, Aeolians or migrations of the Iron Age. Instead, pre-Greek, native populations were mentioned as occupying later Ionian sites such as Miletos. This would be an example of ‘constructed history’ intended to further enhance archaizing effects.⁸⁶ However, this explanation is not entirely satisfactory. For one thing, Athens and Naxos play an obscure role in the Homeric poems, although they had important

⁸⁰ Athens: see esp. *Il.* 13.689–691, but also 2.546–556; *Od.* 7.80–81. Euboeia: *Il.* 2.536–545; 4.464; *Od.* 7.321; also 3.175–179. In the *Iliad*, Euboeia’s inhabitants are Abantes; cf. *Cat. of Women* fr. 204.52–53, 244, 296 [Merkelbach/West], with West 1985, 99, and Kallim. *Del.* 20: Abanti(a)s is the ancient name for Euboeia. Note Hdt. 1.146: Abantes took part in the ‘Ionian migration’, but were ‘not even Ionians in name’; cf. Paus. 7.4.8–10; also 2.3–4, with Jeffery 1976, 230: Euboians from Abai settled in Chios.

⁸¹ *Od.* 3.169–172, e.g., mentions Chios and Psyros only in passing; see also *Il.* 24.78: Samos (=Samothrace). This in contrast to Lesbos and Tenedos, which are dependencies of Troia, see *Il.* 24.544–546, with 9.128–129=270–271, 664; 11.624; *Od.* 17.133–135.

⁸² *Il.* 2.867–868. Cf. Strabo 14.3.1 (ref. to Pherekydes=FGH 3 F 102). On the possible reference to the cult of Poseidon Helikonios at Mykale in *Il.* 20.403–405, see section

6 below. Note also the mention of Abydos and Arisbe, 7th-century foundations of Miletos in the Hellespont, which are among Troia’s allies (836).

⁸³ E.g. Horrocks 1997, 212 f. For discussion about West Ionian (*viz.* Euboian) components, see e.g. West 1992; Sherratt 1990, 820.

⁸⁴ E.g. Simonides, *el.* 19 [West] calls Homer ‘the Chian’.

⁸⁵ West 1988, 165; also Starke 1997, esp. 460–466: familiarity with the Anatolian-Luwian world of the 2nd and early 1st millennium.

⁸⁶ See e.g. Kirk 1985, 248, 262; Kullmann 1999, 190, 194 f., 200; van Wees 2002, 110. According to another school of thought, the absence of Ionia shows that the epics basically reflect a Bronze Age situation; see, recently, ‘Response by J. Latacz on Kullmann (*Gnomon* 73 [2001] 657–663)’, *Bryn Mawr Classical Review* 2002.02.15 (<http://ccat.sas.upenn.edu/bmcr/2002/2002-02-15.html>).

settlements not only in the Iron Age but also during the Bronze Age.⁸⁷ What is more, the epic geography of the eastern Aegean and of western Asia Minor has a distinct *post*-Bronze Age and *post*-migratory ring. This is clear from various non-Greek peoples named in the epics, such as Maionians (i.e. Lydians⁸⁸), Mysians and Phrygians⁸⁹ who are known to have occupied western Asia Minor after the collapse of the Hittite empire. An even clearer example is constituted by the inhabitants of the Dodekanese who, as we just saw, were probably of Dorian stock. In marked contrast to the near absence of Ionians and Ionian territories, these Dorian Dodekanesians play a role of some significance among the allied Greek forces before Troia.⁹⁰

The prominent place of the Dorian Dodekanesians in the epics brings us back to the subject of ethnic identity. Earlier we observed that some sort of ethnic consciousness may have existed in Greece already in the 9th or 8th century, but, as the case of the Dorians shows, the earliest unequivocal evidence of ethnic identity is manifest only in the first half of the 7th century. We saw that on both sides of the Aegean there were Dorians who possessed a supra-local or, indeed, supra-regional collective identity based on ethnic affiliation (being Dorian; triple tribal subdivision) and an elaborate, specifically Dorian mythology (*Ursprungsmythos* centring on a migration story). What is important is that our testimony includes the Dodekanesian Dorians who were neighbours of the East Ionians. This fact makes the virtual absence of references to the Ionians and their habitat in the epics even more remarkable. As I see it, this situation may be explained in two ways. A first possible explanation is that we are confronted with a sort of paradoxical situation: the fact that Ionia and the Ionians were banned from the epics so meticulously presupposes that indeed some kind of Ionian self-awareness and Ionian collective identity existed, based *inter alia* on the belief in large-scale migrations *after* the Trojan war. This explanation would be compatible with a suggestion offered some time ago by Barbara Patzek. She supposes that the dating of the story of the Trojan war before the migratory period makes Asia Minor into an apt location where the contrast between early Greeks and Asiatic Orientals could be made visible. By means of this clear west - east scheme - mainland Greeks vs. Oriental Anatolians - the Ionian audience could give substance to its identification with the Hellēnes.⁹¹ This is an interesting suggestion, although the prominent place that the Asiatic Dorians occupy, especially in the *Iliad*, does not fit comfortably with this idea. Moreover, as other authors have argued, we can observe a process of 'othering' in the epics, but this does not yet make use of stereotyped oppositions between Greeks and barbarian non-Greeks.⁹² However this may be, a second explanation for the virtual absence of Ionians and 'Ionian' localities in the epics should be taken into consideration. This explanation is more straightforward and entirely contrary to the first, as it is based on the supposition that Ionian identity - especially when compared to Dorian identity - was still very much unarticulated, in particular on the east side of the Aegean.

It is not easy to decide how we should interpret the absence of Ionians in the epics. In any way it urges us to pose the question whether a communal Ionian identity already existed in the earlier part of the 7th century. An elegy of Mimnermos of Smyrna (late 7th century) may clarify the matter:

⁸⁷ Naxos-Metropolis area: walled city in LH IIIC, continuity into Iron Age; Lambrinouidakis/Philaniotou-Hadjianastasiou 2001.

⁸⁸ Cf. Hdt. 1.6.3.

⁸⁹ E.g. *Il.* 2.858, 862-877; 10.428-31; further 3.184-189, 401; 4.141; 5.43-44; 16.719; 18.291-292; 20.385, 390-392 (Phrygians, Maionians); 5.628 ff.; 6.150-211; 12.310-314 etc. (Lykians). See also Kullmann 1999, 191 f.

⁹⁰ See also Rhodian-Lykian clashes (*Il.* 5.628 ff.), probably reflecting Iron Age realities, with Crielaard 1995, 275, for further references.

⁹¹ Patzek 1992, 154. This view goes back ultimately to Hdt. 1.3-4.

⁹² E. Hall 1989; Cartledge 1993, 38 f. See further below, section 5.

*Aipy we left, and Neleus' city, Pylos,
and came by ship to Asië's lovely coast.
We settled at fair Kolophon with rude
aggression, leaders of harsh insolence;
from there we crossed the river Asteïs
and took Aiolian Smyrna by god's will.*⁹³

Mimnermos was a near contemporary of Tyrtaios and it is instructive to compare this elegy to the one by Tyrtaios quoted above. The content of both elegies is comparable and there are similarities in the phrasing. For example, both actions took place with divine sanction and both poets speak of 'we', although the events clearly occurred before their own time.⁹⁴ Although it cannot be entirely ruled out that the use of first-person plural verbs was related to poetic conventions (viz. to exhortatory elegy), the broader context of the fragments rather indicates that it was linked to the existence of a self-aware collective identity that was based at least partly on a migration story.⁹⁵ But there is one important difference. Tyrtaios focuses on the early 'history' of the Spartan polis but at the same time refers to the Peloponnese as a whole, which is claimed by a pan-regional or even supra-regional ethnic entity. Mimnermos' foundation story, on the other hand, does not relate to a larger region (such as Ionia) but to two specific localities (Kolophon and Smyrna). This suggests that this collective history was first of all a matter of *local* identity. Although the reference to 'Aiolian Smyrna' may indicate a notion of ethnic opposition (Ionians vs. Aioloans),⁹⁶ no reference is made to Ionian identity in more general terms. We may conclude, then, that by the mid-7th century migration stories existed in cities in East Ionia that helped to create or cement a collective identity. As far as we can judge from Mimnermos, this collective identity was probably not defined in terms of being 'Ionian', just as the foundation story of Kolophon/Smyrna fails to support the idea that the concept of an 'Ionian migration' already existed in this early period.

FOUNDATION STORIES AND THE IONIAN MIGRATION

The notion that the Ionian migration was a genuine, historical event goes back to accounts of ancient authors who believed that the clustering of regional Greek dialects was the direct result of ethnic mass migrations.⁹⁷ The ancients agreed that the Ionian migration took place after the Dorian invasions of the Peloponnese and the Aiolian colonization of northwest Asia Minor.⁹⁸ For the rest, their accounts are far

⁹³ Mimn. fr. 9 [West]. Cf. *Il.* 2.592; Hdt. 1.16, 150; Strabo 14.1.4.

⁹⁴ The capture of Smyrna by Kolophonian invaders may have been a relatively recent event, but it must predate the 23rd Olympiad, i.e. 688 BC, cf. Paus. 5.8.7; also 4.21.5, with Jeffery 1976, 225; Boardman 1980, 29; Cook/Nicholls 1998, 57 f.

⁹⁵ Bowie (2001, 47–49, 66) thinks that Mimn. fr. 9 and perhaps Tyrtaios fr. 2 represent narrative elegy dealing with the recent past and earlier history of Smyrna and Sparta, respectively.

⁹⁶ J. Hall 2002, 72 f. On the other hand, there is the possibility that 'Aiolian Smyrna' embraces a sort of standard

epithet (cf. the so-called *Epigrams of Homer* 4.6), whether or not to differentiate it from other localities of that name (such as the neighbourhood of Ephesos of that name, see below note 194) – just as Hesiod speaks of 'Aiolian Kyme' (*W & D.* 636), perhaps to discriminate it from Euboian Kyme or Kyme in Campania. In other words, it is possible that 'Aiolian' is used in a geographical rather than ethnic sense.

⁹⁷ See e.g. Strabo 8.1.2.

⁹⁸ See e.g. Hdt. 5.76; Thouk. 1.12.4; Strabo 14.1.3. Late antique sources (references in Roebuck 1955, 37 note 5) were even able to produce absolute dates in the earlier 11th century.

from unanimous.⁹⁹ We may try to detect some chronological layering in these stories. As we just saw, Mimnermos in the late 7th century speaks of a migration directly from Neleid Pylos. Allegedly, he considered Andraimon of Pylos to be the founder of Kolophon.¹⁰⁰ Strabo mentions that Miletos was founded by Neleus, ‘a Pylian by birth’, while Neleus’ son Aipyptos was known as one of the founders of Priene,¹⁰¹ which presumably preserves a scrap of a similar, early tradition. What we find then is that, according to this tradition and in contrast to later versions of the story,¹⁰² some of the Ionian cities had been founded *directly* from Neleid Pylos and had nothing to do with Athens, the later champion of the Ionians. Interestingly, there is epigraphic evidence to suggest that already in the first half of the 6th century there existed a cult of Neleus on Samos.¹⁰³ For the sake of clarity, it may be noted that Neleus, the founder of Miletos, cannot be identical with Neleus, the legendary son of Poseidon and father of Nestor, who was the founder or conqueror of ‘Neleid Pylos’.¹⁰⁴ Neleus of Miletos and Andraimon who ‘left Neleid Pylos to settle at Kolophon’ were possibly considered to be his descendants. However this may be, we find that by the 5th century at least another version or perhaps even more than one version of the story of the Ionian migration were in circulation. Herodotos is acquainted with a tradition according to which the Ionians of the Dodekapolis originally lived in the northwest Peloponnese, in the twelve cities of Achaia; one of these was Helike, which – claims Herodotos – lent its name to the cult of Poseidon Helikonios celebrated at the Panionion.¹⁰⁵ As we saw in the introduction, Herodotos tells us that the Ionians who founded the twelve cities in *Asiē* pretended to be ‘more truly Ionian, or *better* born than the other Ionians’. What can be deduced from Herodotos’ description is that these Ionians made these claims on account of their association with the original Ionian homeland in the northwest Peloponnese. Further on in the same passage he reports that there was another category of Asiatic Ionians who proclaimed to be of ‘the *best* born of the Ionians’.¹⁰⁶ The Milesians seem to have held this claim, pointing out that they had started out from the *prytaneion* (‘city hall’) in Athens. This claim is possibly connected with another element of the tradition regarding the Ionian migration or, alternatively, a different version of the story that Herodotos was

⁹⁹ For fundamental source criticism, I refer especially to E. Prinz 1979, 314–376; Cobet 2007.

¹⁰⁰ Strabo 14.1.3, referring to Mimnermos’ *Nanno* (=fr. 10 [West]).

¹⁰¹ Strabo 14.1.3; Paus. 7.2.10. Further Paus. 7.2.6 (Neleus’ tomb outside Ephesos); Plut. *Mul.virt.* 16, with Jeffery 1976, 210 (feast).

¹⁰² See Paus. 7.3.3 and also below.

¹⁰³ Inscribed bronze miniature vessel mentioning priest of Neleus from the Heraion; see Lazzarini 1978; Jeffery 1990, 471 C.

¹⁰⁴ *Od.* 11.252–257; see also *Catalogue of Women* fr. 33a [Merkelbach/West]. According to ‘Eumelos’ (fr. 6B, D=Paus. 2.2.2.), Neleus, father of Nestor, died at Korinth and was buried in an unknown grave on the Isthmos.

¹⁰⁵ Hdt. 1.145, 148 (cf. 149: the twelve Aiolian cities); also 7.94: still in Achaia they were called Aigialean Pelasgians (‘P. of the Coast’). After the coming of Xouthos, they took their name from his son Iōn. The same applied to the islanders (95.1; also 8.46.2–3, 48). An Achaian origin is also mentioned by the 4th-century poet Timotheos of Miletos, *Pers.* 246–248. According to Morgan and Hall

(1996; also J. Hall 2000, 389–396, 399; 2007, 64 f.), the Achaian connection was elaborated during the 7th and 6th centuries as a result of Achaian and Ionian colonial rivalries in southern Italy. The story seems to have emphasized that in the past the Achaians had forcibly displaced the Ionians from Achaia, just as they more recently (mid-6th c.) had expelled the Ionians from Siris. But cf. Malkin 1998, 211 f.: founder’s cult of Neleidai at Metapontion serving to stress the commonalities between neighbouring Achaian and Ionian colonies.

¹⁰⁶ Hdt. 1.146.1: ‘... μάλλον οὔτοι Ἴωνές εἰσι τῶν ἄλλων Ἴόνων ἢ κάλλιόν τι γεγόνασι’; 146.2 ‘... καὶ νομίζοντες γενναιότατοι εἶναι Ἴόνων’. These and other claims were refuted by Herodotos. J. McInerney (2001, 57–59) points out that the historian seeks to contest the ethnic unity of the East Ionians and their ethnic identity on the basis of the same essentials that appear in his definition of Greek ethnicity (Hdt. 8.144; see also above, note 45). In Herodotos’ view (1.147), the only real Ionians were those who were of Athenian descent and celebrated the Apatouria. Cf. comments in Thomas 2001, 225 f.

acquainted with. It is not clear from his scattered and allusive account whether he pictured the Ionians expelled from Achaia to have resettled in Attika before migrating to the eastern Aegean, but he states plainly that the Ionian Dodekapolis was founded from Athens. This may be identified as the ‘Athenian’ version of the Ionian migration and its Pylian connection in which Neleus or Neileos, the founder of Miletos, is presented as the son of the mythical Athenian king Kodros, who was made into a descendant of Neleus, king of Pylos.¹⁰⁷ Since Kodros had become king of Athens, the colonization of Ionia from Pylos was then pictured to have taken place indirectly, via an Athenian detour. Later authors, such as Pausanias and Strabo, present the stories in a more elaborated form by incorporating various local and sometimes older versions and making them compatible. In this late, synthesized version, twelve of Kodros’ sons (including bastard sons and a grandson) took the Ionians, who previously had been expelled by the Achaeans and had come to Attika, and led these refugees to Asia Minor where they founded the twelve Ionian cities. The supreme commander was either Neleus, the founder of Ionian Miletos, or Androklos, the founder of Ephesos, depending on the respective claims to primacy of these cities.¹⁰⁸

Thus, we catch a glimpse of how traditions concerning the Ionian migration developed from the 7th to 5th centuries and later. The origin of these traditions perhaps lies in heroic genealogies and ancestor myths of local aristocratic families or royal dynasties wishing to trace back their pedigree to gods, epic figures or other heroic progenitors, as did for example the Neleidai, the *genos basileiōn* at Miletos, and the Aipytidai, the royal clan of Priene.¹⁰⁹ The construction of ancestor myths provided elite families with an illustrious lineage and helped to legitimate their position in society. But they were also a form of ‘intentional history’, as they were intended to explicate the political alliances that existed between some families, or the competition for superior status and more ancient descent taking place between others.¹¹⁰ Significantly, some of these family genealogies are incompatible with divisions that existed later between Ionians and Aiolians, and between Greeks and non-Greeks.¹¹¹ Possibly as a next stage, stories of wandering ‘heroes’ were extrapolated to migratory stories that served as ‘ancestor myths’ for a large part of the polis population. We can read between the lines that in Ionia a great variety of local foundation stories must have existed, involving ‘Pylia’ or ‘Ionian’ settlers, but also a staggering number of other ethnic groups, both Greek and non-Greek.¹¹² These local myths were not necessarily mutually compatible. This relates especially to the Neleus legend that seems to have had a different development on each side of the Aegean. During the 7th

¹⁰⁷ Hdt. 1.147; 5.65; 7.94; 9.97; Hellan. *FGH* 4 F 125, with Heinzl 1999, 3, 9 f. J. Hall (2007, 57) suggests that the tradition that the Ionians were the former residents of Achaia who fled to Attika before setting out to colonize the Anatolian coast is a 5th-c. rationalization to account for the fact that both regions are independently named in earlier sources as the original Ionian homeland. In late 5th-century Attika there existed a chthonic cult of Neleus and Basileia (Lazzarini 1978, 181), which opens up the possibility that a local hero named Neleus was incorporated into the stories of the Kodrid kings and Ionian migration.

¹⁰⁸ Paus. 2.18.7; 7.1–4 (note that Andraimon, who is a Pylian according to Mimnermos, is here made into a son of Athenian Kodros); also 7.6.1–2; Strabo 8.1.2, 7.1–4; 14.1.3 ff. Further Aelian *VH* 8.5; Zenobius *Adag.* 5.17.

¹⁰⁹ Cf. *Il.* 20.307–308, with *Hom. hymn Aphr.* 196 ff. (with Smith 1981): Aineidai at Troia; Hdt. 5.65.3: Peisistratidai

at Athens; also 2.143: Hekataios of Miletos.

¹¹⁰ Agamemnonidai: at Pygela near Mykale (Huxley 1966, 27, with note 56 for references), Kyme and Mytilene (Strabo 9.2.5; 13.1.3); cf. also Sappho fr. 17 [Voigt]. Herakleidai: Sardeis (Hdt. 1.7, 91), Dodekanese (see section 4.1 above).

¹¹¹ In the *Iliad* both Tlepolemos, the Heraklid ruler of Rhodos (2.659), and the Lykian king Glaukos (6.152, 210) have roots in Ephyre on the Peloponnese. What is more, Glaukos was a descendent of Aiolos (6.152 ff.); and yet this did not prevent some of the Ionian ruling families to trace back their pedigree to Glaukos (see Hdt. 1.147).

¹¹² E.g. Hdt. 1.146. Further below, note 142. Note also in this context the strong Boiotian ‘undercurrent’ in the foundation myths of especially Priene, Melie, Kolophon and Teos, see Cook 1961, 12; Huxley 1966, 27 f.; Kleiner *et al.* 1967, 80; Emlyn-Jones 1980, 21, 25, 66) – all with references.

and 6th centuries many local histories were composed which combined local myths with episodes from a more recent past. Semonides' *archaiologia* of the Samians', Mimnermos' *Smyrneis* and Xenophanes' 'foundation of Kolophon' all celebrated local identity.¹¹³ If historiography can be taken as indicative of changes in identity, the 5th century must have been a turning point. We see a shift to overarching narratives tying together traditions of several local communities.¹¹⁴ Examples of this shift are accounts by Pherekydes of Athens¹¹⁵ and Panyassis of Halikarnassos. Both dealt with the early migrations from mainland Greece and testify to a shift in focus towards a communal, Ionian identity. But there is more. From Panyassis' *Iōnika* onwards, Athens started to employ these migration stories for propagandistic purposes, especially to substantiate her leadership within the first Delian–Attic League.¹¹⁶ In ancient Greece, it was not uncommon to refer to the past to underline special relationships between two or more states, and if necessary, traditions were fabricated or reinvented. The more ancient and respectable the relationship, the higher the degree of solidarity and loyalty the parties would experience.¹¹⁷ Athens, however, went one step further by creating a tradition that stressed the ethnic purity of the Athenians and advertised Athens as the most Ionian city of all. By means of elaboration or possibly even appropriation of the Neleus legend, Athens sought to substantiate its claim to be the metropolis of all Ionians. It is probably in this context that we have to put Herodotos' remarks about conflicting traditions that were utilized to claim and contest degrees of purity of Ionian blood.¹¹⁸ At the same time, the Ionian cities seem to have accepted the story of a single organized act of colonization¹¹⁹; their response to Athens' claims was to credit themselves retrospectively with a venerable past that included foundation by one of Kodros' offspring.

TRIBAL SUBDIVISIONS

Like the Dorians, the Ionians were subdivided into *phylai* ('tribes'). In Athens before Kleisthenes four tribes existed (Geleontes, Argadeis, Aigikoreis and Hopletes).¹²⁰ In a number of Ionian cities or their colonies some of these tribal names have been attested, in addition to other names (such as Oinopes and Boreis, after Boros, an ancestor of Neleus). As remarked in the introduction, these subdivisions are generally considered as fossilized relics of a tribal structure that had pertained in the premigratory period, although those employed in Ionia are sometimes considered as local inventions of a later date.¹²¹ More recently, however, the evidence has been more critically appraised. It has been suggested that Ionian tribal names became standardized when the Ionians came to identify themselves as a cult community or as a dialect group during or after the Dark Ages.¹²² Gehrke argues that these groups were created as a cohesive force within the context of the incipient polis. He postulates that – thanks to observable linguistic and religious similarities – groups in the eastern Aegean identified themselves with mainland Ionians.

¹¹³ In comparison to these works, the treatise on the future of Ionia by Bias of Priene (see Diog. Laert. 1.85; cf. Hdt. 1.170) seems conspicuously precocious.

¹¹⁴ Bowie 1986, 27–33; 2001, 49 f.

¹¹⁵ Cf. Strabo 14.1.3.

¹¹⁶ It has been suggested that this happened already during the 7th or 6th century on the initiative of cosmopolitan or politically ambitious elite families, including the Peisistratidai, see J. Hall 1997, 52 f.; I.S. Lemos 2007, 714, both with further refs.

¹¹⁷ Gehrke 1994, 239 f.

¹¹⁸ Hdt. 1.147: there are East Ionians of pure birth (οἱ καθαρῶς

γεγονότες Ἴωνες) and all are Ionians who are of Athenian descent.

¹¹⁹ See e.g. Thouk. 1.12.4 (about early Greeks sending out colonies): '... as Athens did to Ionia and most of the islands, and the Peloponnesians to most of Italy and Sicily'; see further Roebuck 1955, 34.

¹²⁰ Hdt. 5.66.2.

¹²¹ E.g. Sakellariou 1958, 132–135, 278, 396; Roebuck 1961, esp. 499 f.; Huxley 1966, 32.

¹²² Roussel 1976, 215; Piérart 1985, 169–190; Patzek 1992, 112; Cobet 2007, 738.

But whereas the *Ionierbegriff* supposedly spread from east to west (from the Panionion to the islands and then to the mainland), the internal division into *phylai* would have moved in the opposite direction.¹²³ A similar east – west crossing has been suggested for the Apatouria,¹²⁴ the festival marking the admittance of new members to the *phatriai* which Herodotos considers as one of the hallmarks of the true Ionians.¹²⁵

This is not the place to explicate this topic. What should be noted, however, is that cities in Ionia seldom possessed the same set of subdivisions, that is, tribal names that exactly correspond. Where they did possess the same set, we should seriously consider the possibility of borrowing and ‘cross-fertilization’. Moreover, literary testimony is very clear in showing that such subdivisions as *phylai* were highly dynamic entities that could be reinvented unimpededly.¹²⁶ This means that we cannot exclude that tribal subdivisions and ethnonyms – as well as other social institutions such as calendars and festivals – were borrowed rather than inherited¹²⁷ and could be part of ‘invented’ traditions that helped to create supra-local communalities and a common history. At the same time, we may assume that such traditions could be manipulated or appropriated, for instance to substantiate claims to seniority and superiority.

THE IONIAN MIGRATION AND ARCHAEOLOGY

To conclude this section we will look at independent sources outside the ancient migration stories that can shed light on Ionia’s early history. For this we have to go as far back as the fourteenth and thirteenth centuries BC. In this period we find a number of political entities existing in western Asia Minor. Among them are Millawanda, probably the Bronze Age predecessor of Miletos, and Apaša or Ephesos of later times, which during the Bronze Age, however, was the capital of the Luwian kingdom of Arzawa. The region maintained contacts with the inland Hittite empire and, in particular, Ahhiyawa. The latter denotes probably some ‘Achaian’, viz. Mycenaean, centre of power, on either the islands or the Greek mainland. Hittite texts seem to suggest that Millawanda lay under the authority of the Great King of Ahhiyawa.¹²⁸ Excavations at Miletos have yielded architecture, pottery and tomb types indicating that the site was inhabited by Mycenaeans or, at least, that it had very close links with the Mycenaean world.¹²⁹ At Ephesos, the Ayasuluk hill contained a fortified settlement belonging to a population with a mixed Anatolian-Mycenaean material culture. Also below the later Artemision at Ephesos traces of Late Bronze Age occupation were brought to light, including a cult place with Mycenaean traits.¹³⁰ Painted pottery

¹²³ Gehrke 2000, 159 f., 163, 167–171; also Ulf 1996b, esp. 271. J. Hall (2002, 71) that the term Ionia/Ionians originated in coastal Anatolia. On tribal structures, see also J. Hall 2007, 56: “the tribe was a subdivision of – and consequently, subsequent to – the *polis*”.

¹²⁴ Huxley 1966, 31; Connor 1993, 197; J. Hall 2007, 54.

¹²⁵ Hdt. 1.147.2; see also Thouk. 2.15.4.

¹²⁶ See, notably, Kleisthenes’ reforms, but also the so-called ‘Chian Laws’ (c. 575 – 550), discussed in N.F. Jones 1987, 14–17, with 13, 191–193; also Murray 1990, 12–16.

¹²⁷ Connor 1993, 197; *pace* Gorman 2001, 37 ff. J. Hall (2007, 53 f.) points out that the calendars of Athens and Miletos only partly overlapped; perhaps even more significant are correspondences between the names of months used in Ionian Miletos and Dorian Rhodos.

¹²⁸ Discussion of Hittite sources: Bryce 1998, 54–63, 209–

214, 230–234, 336–344; Hawkins 1998, 28, 30; Niemeier 1999a. Interregional relations: Hawkins 1998, 18, 22, 28, 30; Mountjoy 1998, 47 f.; Niemeier 1998, 32–34; 1999a, 144; Niemeier/Niemeier 1997, 205. Recent opinions on Ahhiyawa’s location: Mountjoy 1998, esp. 47, 50 f., 60; Hawkins 1998, 30; Niemeier 1998; Latacz 2004, 121–128 (all with further references).

¹²⁹ Niemeier/Niemeier 1997, esp. 190–200, 219–229, 244 f.; also Bryce 1998, 321, 395; Niemeier 1999a, 152 (Tawagalawa/Eteokles). For Hittite-style of fortification, iconography on LH III B2–III C krater etc., see Niemeier 1999a, 153 f.; Niemeier/Niemeier 1997, 200–205.

¹³⁰ Bammer/Muss 1996, 25–28; Niemeier/Niemeier 1997, 244–248; Mountjoy 1998, 36; Büyükkolancı 2000; S.P. Morris 2001; Muss 2001. Cf. Hanfmann 1962: Hittite priest statuette.

found on the eastern Aegean islands and the west coast of Asia Minor corroborates the picture that intensive communications existed with the Mycenaean world.¹³¹

Like elsewhere in the Aegean, there were violent destructions near the end of the Bronze Age.¹³² More significant, however, is that a number of settlements managed to survive into the post-palatial, LH IIC period.¹³³ Continuity of population is also suggested by the development of a homogeneous pottery style in the southeastern Aegean covering the (palatial) LH IIIB2 as well as the (post-palatial) LH IIC period.¹³⁴ There is ceramic and other archaeological evidence for continuous inhabitation even from the Bronze to the Iron Age in Samos, Klazomenai/Limantepe, Ephesos (both Ayasuluk hill and the Artemision), Miletos, and Assesos and Teichioussa in the area of Miletos, and possibly also at Chios, Erythrai and Kuşadası.¹³⁵ Needless to say, in historical times these places ranked among the most important Ionian cities. In other places the earliest Iron Age material is later (see e.g. Protogeometric at Smyrna, Phokaia, Teos and Klaros), although it should be added that at some of these sites the final Bronze Age or early Iron Age levels have not been reached or they appear to have been destroyed by large-scale building activities of later periods.

Apparently, the settlement history of the east side of the Aegean was rather similar to that of the western part (i.e. fortified LBA settlements, destructions, relatively flourishing IIC coastal sites, continuous inhabitation in some places), and the two regions seem to have enjoyed more or less uninterrupted contacts during the Bronze – Iron Age period. With the archaeological information we have today, it would be overdramatic to cling to the picture of the eastern Aegean as ‘a potentially or actually hostile shore’, separated from mainland Greece by ‘a hundred of miles or more across dangerous seas’.¹³⁶ In fact during the Bronze–Iron transition the western and eastern Aegean were parts of the same cultural area,¹³⁷ and we see that new pottery styles, house types and burial customs were picked up more or less simultaneously on both sides of the Aegean.¹³⁸

¹³¹ Niemeier/Niemeier 1997, 244 f.; Mountjoy 1998, 33 f., 36 f.

¹³² Miletos: Niemeier/Niemeier 1997, 205 f., 216, 218 (either LH IIC Middle or Late). Sardeis: Hanfmann 1983a, 22–25 (destruction: c. 1200).

¹³³ E.g. Panaztepe–Menemen (LH IIC Early); Bademgediği Tepesi–Torbalı (fortified site near classical Metropolis; LH IIC Early); Emporio, Chios (LH IIC Middle–Late); Ephesos (LH IIC); Miletos (LH IIC Middle/Late); see further Troia (LH IIC Early [and: Middle?]), Pitane, Müskebi and Iasos (LH IIC), see Mountjoy 1998, 35 f., 53, 60; 1999, 1147–1155; Greaves/Helwing 2001, 506; Meriç 2002.

¹³⁴ Mountjoy 1998, 51–63; 2005: her late LH IIIB–LH IIC Early–Middle ‘East Aegean Koine’. Not including Rhodos that displays a new, but flourishing material culture, which Mountjoy (1998, 63) is inclined to connect to newcomers (from Krete?). I.S. Lemos (2007, esp. 723 f.) argues that migrations to the eastern Aegean started in LH IIC

¹³⁵ Samos: Milošević 1961, 70; Walter 1968, 11; also Jarosch 1994, 53: evidence of 10th-century cult. Klazomenai/Limantepe: Greaves/Helwing 2001, 505; Aytaçlar 2004,

27–30. Ephesos, Ayasuluk: Büyükkolancı 2000; Artemision: Bammer 1990, 142; also I.S. Lemos 2002, 212; 2007, 720. Miletos, Zeyintepi: Niemeier/Niemeier 1997, 205 f., 216, 218; Greaves 2002, 75; but cf. I.S. Lemos 2002, 212; 2007, 719–724. Assesos (on Mengerevtepe, 7 km SE of Miletos) and Teichioussa (Saplı Adası peninsula, Gulf of Akbüük): Lohmann. 1995, 311–322; 1997, 290; 1999, 446 ff.; also 2007, 364–372. Chios: Boardman 1980, 31 f.; Mountjoy 1999, 1147–1155. Erythrai: Cook 1960, 40; Cook/Blackman 1971, 41; Simon 1997, 128. Kuşadası–Kadı Kalesi: Mercangöz 2002, 274 f. See also Halikarnassos–Mylasa area: Niemeier 2007, 88; Sardeis: Hanfmann 1983a, 22–25.

¹³⁶ Snodgrass 1971, 373.

¹³⁷ Patzek 1992, 11 f. makes a similar point.

¹³⁸ E.g. at Klazomenai/Limantepe: Aytaçlar 2004; Ersoy 2007, 151–153. I am inclined to see the local production of PG finewares and cooking wares at Miletos and Ephesos (Niemeier 2007, 89, with refs.) in the same light. Among archaeologists dealing with the Ionian migrations, there is a tendency to focus on Attic and Atticizing pottery from the PG period found in Ionia (e.g. *ibid.*, 89 f.; Kerschner 2006), but it is important to note that Ath-

It is not easy to reconcile this picture with that of one or more waves of migrants instigating new communities and cultures. In this light it is rather ironical that Miletos and Ephesos – the cities that later claimed to have been the first to receive a large body of Ionian settlers – have produced the best evidence for continuous occupation. Apart from settlements that were inhabited without interruption, archaeology provides evidence of a prolonged process of occupation or reoccupation of sites and more sparsely populated areas – presumably sometimes attended with conquest by force.¹³⁹ Instances of warlike and forceful acquisition of land that have been attested for the 8th and 7th centuries (see also section 5 below) can be considered the final stage of this process that is characterized by the gradual settlement of the coastal landscape of Asia Minor.¹⁴⁰ It is possible that as part of this process new settlers arrived who brought with them the proto-Ionian dialect, although migration is certainly not the only means of diffusion of a language.¹⁴¹

If we adhere to this model of continuous inhabitation and desultory infiltration, the stories of a concerted Ionian migration leading to a massive influx of settlers must be considered as fabrications of a later period. What is compatible with this model, though, are the frequent references to non-Ionian or Anatolian elements in the population in these foundation stories. Herodotos, for example, to support his claim that the Asiatic Ionians were not more truly Ionian than the other Ionians, points out that also Greeks from other regions had settled in Ionian cities, the settlers of Miletos even having taken brides after killing their male relatives; other cities, he says, were ruled by Lykian kings.¹⁴² Although Herodotos presents this information to contest the ethnic identity and ethnic unity of the East Ionians, it is likely that he took this information from local traditions. Another recurrent element in these foundation stories is that of Greeks expelling or killing Karians and other indigenous inhabitants. This can be seen as a form of colonial discourse, similarly known in the West,¹⁴³ that can be interpreted as later attempts to ‘prove’ the community’s homogeneity and ethnic purity.

5 COMMON WAY OF LIFE

WARLIKE BEHAVIOUR AND COLLECTIVE IDENTITY

In the ancient sources, the Greeks living in Ionia are often portrayed as luxury-loving, decadent and effeminate. This can be considered a cliché that became popular especially after the Archaic period (see below). The fact is that a variety of sources show that war, conquest and piracy run like a continuous thread through the history of the Ionian Greeks. It is probably no accident that the first fortified settlements of the Iron Age are found in Ionia and the Kyklades.¹⁴⁴ During the ensuing Archaic period some East Ionian poleis clung to piracy and naval warfare (during the 7th and 6th centuries, in particular

ens is certainly not the only locality responsible for the diffusion of imports and influences and that *koinē* pottery styles ‘crossing’ the Aegean are a phenomenon that includes regions outside later Ionia (see e.g. I.S. Lemos 2002, 212 ff.; 2007, 718 f.; Ersoy 2007, 151 f.), while the distribution of PG pottery within later Ionia does not correspond with those places that later become the major Ionian cities (point made by Lohmann 2004, 32 f.).

¹³⁹ See also Patzek 1992, 111.

¹⁴⁰ Pollen diagrams from SW Anatolia show increase of anthropogenic activity from c. 1450 BC onwards, see

Eastwood *et al.* 1998.

¹⁴¹ Cf. J. Hall 1997, 162-170; also 2007, 56 where he argues against the assumption that dialectal correspondences are due to their shared descent from a protodialect.

¹⁴² Hdt. 1.146-147. See further Hom. *Il.* 2.867-869; Thouk. 1.8.1; Strabo 14.1.3; Paus. 7.2.2-4.6. According to the latter (7.2.5), only Klazomenai and Phokaia were non-existent before the coming of the Ionians. For mixed marriages, see also Coldstream 1993, esp. 96-98.

¹⁴³ Cf. Yntema 2000.

¹⁴⁴ Crielaard 2009, 363.



Fig. 4. Mt. Mykale seen from the island of Samos (photo by the author)

Samos and Phokaia)¹⁴⁵, while other, mainly inland cities were renowned in antiquity for their powerful cavalry (notably Kolophon and Magnesia on the Maiandros).¹⁴⁶ During the 7th and 6th centuries East Ionians fought in the armies of the Babylonians and Persians, and served the Egyptian pharaohs of the 26th Dynasty (between c. 663 and 570) as footsoldiers, marines and bodyguards, often alongside their Aiolian, Dorian and Karian neighbours.¹⁴⁷

I wish to point out that war and violence must be regarded as major cohesive forces.¹⁴⁸ It can be argued that war and warlike behaviour played a significant role in collective identities at both a local and

¹⁴⁵ Samos: e.g. Thouk. 1.13.2-3; Hdt. 3.39 (fleet of tyrant Polykrates, c. 532 - 522 BC); further Hdt. 1.70; 3.47; 6.223. Phokaia: e.g. Hdt. 1.162-167; 6.17 (freebooting); Thouk. 1.13.6; cf. Mele 1979, esp. Ch. 8. Further Hdt. 2.152 (Ionian and Karian marauders in Egypt).

¹⁴⁶ Kolophon: Polyain. *Strat.* 7.2.2; Strabo 14.1.28, with Talamo 1973; Fogazza 1974. Magnesia: Arist. *Pol.* 4.3.1-2.

¹⁴⁷ Hdt. 2.152-154, 161, 163, 169; see further 3.1, 4, 44; Diod. 1.67.1. Aiolians: Alkaios fr. 350 [Voigt]; Hdt. 3.13-15; also Jeffery 1990, 360 f.: 2 (signature by Kaikos of Magnesia at Abydos). Dorians: Jeffery 1990, 348, 354 f., 358 (4, 48, 52). For further evidence of East Greek mercenaries in Egypt and the Near East during the 7th and 6th centuries, see Boardman 1980, 50-52, 114-117, 133-137; Bettalli 1995; Haider 1996; Niemeier 2001;

Vittmann 2003, 197 ff.; also Fantalkin 2001, esp. 74-97, 140 ff.; N. Luraghi 2006. East Greeks possibly serving under the Assyrians: Bettalli 1995, 44-46; Haider 1996, 93 f.; also N. Luraghi 2006, 41; fighting together with Phrygians: Lanfranchi 2000, 17-22; in the army of the Lydian king Kroisos: Roebuck 1955, 38 note 29. Karians: Archil. fr. 216 [West]; Hdt. 2.152-154, 163; 5.110-111; Polyain. *Strat.* 7.3, with Vittmann 2003, 155-179. Karians in 7th- and 6th-century Sardeis: Gusmani 1982, 129; in late 6th-century Babylonia: Fantalkin 2001, 130 note 59; Waerzeggers 2006. Lydians helping Psammetichos I: Niemeier 2001, 17 f., with references; also Tyrus (?): Ezek. 27.10.

¹⁴⁸ For early Greek warfare as a means of interaction and communication, see also Snodgrass 1986, esp. 51 f.

a supra-local level. We may start with the importance of war for collective identity and self-representation at the level of local communities. Earlier I quoted the 7th-century poet Mimnermos. His poetry shows that in the charter myths of Kolophon and Smyrna not only migration, but also conquest and violence (on the verge of communal *hybris*) were presented as elements that unified the inhabitants.¹⁴⁹ Conquest and acquisition of territory were also a way of life for island polities such as Samos and Chios, which during the 8th and 7th centuries were busy carving out territories (*peraia*) on the opposite coast of Asia Minor.¹⁵⁰ On top of that, there were conflicts with equally warlike, non-Greek neighbours, such as Karians, Kimmerians and Lydians.¹⁵¹ Conflicts with these inland peoples seem to have fostered, first of all, a kind of local solidarity focussing on the polis community. This is clear from the martial elegies that the 7th-century poets Kallinos of Ephesos and Mimnermos of Smyrna composed to exhort their fellow citizens to fight to the death against outsiders threatening their polis.¹⁵² Absent in these poems are hints at an antithesis based on ethnic oppositions along the lines of the Greek Self vs. the non-Greek culturally Other. To the contrary, the Lydians, who were the main opponents of the Ionians, were foes and simultaneously role models (see section 5 below). Symptomatic of this situation is also that the Ionian cities never felt induced to operate as one united front against these adversaries;¹⁵³ it is therefore questionable whether this external threat did much to foster a common Ionian identity.

War and violence were important for collective identity and self-representation also at a supra-local level, but this operated differently than one would perhaps expect. Literary information on warlike and diplomatic relationships during the Archaic period creates the strong impression that the East Ionian cities found friends *and* foes first and foremost among their own kind (and hardly among the neighbouring Dorian Dodekanesians, for instance), and secondly among the Ionian cities in the Kyklades and, more incidentally, Euboia.¹⁵⁴ Attika appears to be somewhat outside this orbit of alliances and animosities.¹⁵⁵

¹⁴⁹ The mention of *hybris* in Mimn. fr. 9.4 possibly served to explain the later punishment of Kolophon, presumably in the form of its capture by the Lydian king Gyges, see Hdt. 1.14.4, with Fisher 1992, 213–216; J. Hall 2000, 393.

¹⁵⁰ See Shipley 1987, 30 f., 35, 47; Debord 2001; further Jeffery 1976, 208 f., 221; cf. 89, 237 (Lesbos). Naturally, these acquisitive actions led to conflicts with neighbouring polities.

¹⁵¹ Karians: e.g. Alkaios fr. 388 [Voigt] (c. 600); Anakreon fr. 401 [Page] (6th century), with Snodgrass 1964, 107–118. Kimmerians: Kallinos fr. 5a; also Archil. fr. 20 [West]; cf. Hdt. 1.6.3; Strabo 1.3.21; further references in Cobet 1997, 255 f. Lydians: see above.

¹⁵² See e.g. Kallinos frs. 1; 5a, 4 [West]; Mimn. fr. 14 [West]. For other references to wars between Ionians of Kolophon and Smyrna, and the Lydians under Gyges, see Hdt. 1.14; Paus. 4.21.5; 9.29.2; Strabo 14.1.4.

¹⁵³ For e.g. the different relations that especially Miletos, Priene and Ephesos maintained with Lydia, see Jeffery 1976, 221, 223.

¹⁵⁴ Alliances: Miletos and Chios, vs. Erythrai and Lydia (before c. 600; Hdt. 1.18.3); Miletos and Paros (Archil. fr. 192 [West]); Miletos, Erythrai and Paros jointly colonizing Parion (c. 710 BC; Strabo 13.1.13–14); Miletos and

Erythrai, vs. Naxos (Andrisko *FGH* 500 F 1; Plut. *Mor.* 254b–f; later hostilities: Hdt. 5.30 ff.); Eretria and Miletos vs. Chalkis and Samos (7th century?; Hdt. 5.99.1). See further arbitrations by Paros, Samos and Erythrai in dispute between Andros and Chalkis over Akanthos (mid-7th century; Plut. *QG* 30), and by Paros in Milesian conflict (c. 520; Hdt. 5.28–29). Wars: Kolophon's conquest of Smyrna (Mimn. fr. 9 [West]; Hdt. 1.150); Chios vs. Erythrai (Plut. *Mor.* 244e–245a; Polyain. *Strat.* 8.66; cf. Jeffery 1976, 212, 229 with note 10, 230); Miletos vs. Myous (Plut., *Mor.* 253f.); Ephesos vs. Magnesia (before c. 640; Athen. 12.525c, ref. to Kallinos and Archilochos; cf. Huxley 1966, 83); Samos (and Miletos) vs. Priene (over Mykale's territory, earlier 6th century; Plut. *QG* 20); Miletos vs. Melos, and Miletos vs. Karystos in Euboia (Konon *FGH* 26 F 1, xlv; Nic. *Damasc.* *FGH* 90 F 52–53); Samos vs. Lesbos (ally of Miletos, later 6th century; Hdt. 3.39.4). Tausend 1992, 70–89 provides a sketch of the historical backgrounds.

¹⁵⁵ Aristocratic alliances in Athens, Naxos and Euboia: Hdt. 1.61, 64; Athens, Eretria and Miletos vs. Persians in 498: Hdt. 5.97 ff., with Tausend 1992, 123–126. Wars of Athens vs. Mytilene in Hellespont region (later 7th and 6th centuries), see e.g. Alkaios fr. 401b [Voigt]; Hdt. 5.94–95, with Jeffery 1976, 89–90, 238–239.

Perhaps the most explicit example of the relationship between war and supra-local identity is provided by the fragmentarily preserved story of what Vitruvius calls ‘the war with Melite’. He adds that, ‘because of the arrogance of its people’ this city was destroyed by the Ionian cities jointly.¹⁵⁶ Earlier sources refer to the *Meliakos polemos*, the war about Melie. Melie (or Melia) may have been either a Karian or an Ionian-Karian settlement.¹⁵⁷ Apparently it was powerful and dominated a large territory. Epigraphic evidence of a much later date tells us that Melie’s land was divided up, probably between Samos, Priene, and Miletos, while Kolophon was perhaps also involved in some way.¹⁵⁸ What is particularly important in this context of supra-local, Ionian identity is the date of this conflict, also because the Panionion – the common East Ionian sanctuary of Poseidon Helikonios – was established supposedly after the ‘Meliac war’. This sanctuary lay on the north side of Mykale,¹⁵⁹ the coastal spur that commands the fertile plane to the north as well as the narrow strait between Samos and the mainland (fig. 4). Melie has been identified with the site of Kaletepe near Güzelçamlı. Kaletepe lies two kilometres southwest of the remains of large-scale architecture that have been connected with the Poseidon sanctuary (present-day Otomatik Tepe). The earliest occupation phases at Kaletepe date to Protogeometric and Geometric times. The fortification wall on the acropolis was constructed and reinforced possibly between c. 750 and 650 BC, and a lower enclosure wall was added around 600 BC.¹⁶⁰ On the basis of circumstantial evidence, the destruction and subsequent abandonment of the site are dated for reasons of convenience to c. 700 BC.¹⁶¹ However, the archaeological evidence is generally flimsy, and there are no clear indications of a break in the site’s occupation after 700.¹⁶² It is even doubtful whether Kaletepe can be identified with Melie at all. Hans Lohmann has found a fortified settlement that was seemingly destroyed around 600 BC on the north side of Mykale at Çatallar Tepe, which he identifies as the site of Melie and the Panionion (see section 6 below).¹⁶³ To be brief, the story of the joint destruction of Melie may have served as a kind of charter myth common to the Ionians of Asia Minor. However, if it was based on a historical event at all, this event may be dated closer to 600 than to 700 BC.

MATERIAL CULTURE: LUXURY AS SELF-EXPRESSION

During the 7th and 6th centuries an elitist culture was adopted in Ionia and Aiolis, centring on *habrosynē* and *tryphē*. These two terms can be understood as ‘graciousness’ and ‘hedonistic luxury’, verging on wantonness. They typified the leisure class of the Archaic period and were intimately connected with a specific elitist notion of freedom.¹⁶⁴ Living in luxury was a way of life or, rather, a style of private expenditure that found expression especially in gorgeous attire, perfumes and other forms of personal adornment, as well as

¹⁵⁶ Vitruv. *De arch.* 4.1.3–5.

¹⁵⁷ Kleiner *et al.* 1967, 78–80. Hekataios (*FGH I* 11; c. 500) calls it πόλις Καρίας, ‘Karian city’.

¹⁵⁸ Roebuck 1955, 32 f.; Jeffery 1976, 208 f.; Ragone 1986; Tausend 1992, 70–74 Lohmann 2004, 38 – all with references.

¹⁵⁹ Hdt. 1.148; Diod. 15.49; Strabo 8.7.2, 14.1.19.

¹⁶⁰ Kleiner *et al.* 1967, 81–83, 97–8, 116, 161–170 (PG-G); 97, 116, 133 f., 141–144 (*Oberburg*); 81, 89, 108, 116, 130–132 (*Unterburg*).

¹⁶¹ P. Hommel in Kleiner *et al.* 1967, 91 f.; Jeffery 1967, 208 f.; Simon 1997, 126.

¹⁶² For later finds, in addition to the earlier 7th-century rein-

forcements of the acropolis wall, see the LG-SubG *Grabau* (Kleiner *et al.* 1967, 167–170) and, on the acropolis, later 7th-/earlier 6th-century houses (p. 90, 97, 118–123, 134) and other finds from the early 7th to mid-6th centuries (p. 95, 116; 133–158). Cf. also Tausend 1992, 77.

¹⁶³ Lohmann 2004, 38 f.; Lohmann *et al.* (2007, 80, 102 f.) consider Kaletepe as a *Fluchtburg*, to be identified with Karion Phrourion mentioned in later inscriptions from Priene.

¹⁶⁴ See Diod. 8.20: ‘the Milesians living in luxury’ (Μιλησίων τρυφόντων); a visiting Sybarite reported to his fellow citizens that he had seen but one free Greek city which was the city of the Milesians.

copious food and drink.¹⁶⁵ Ian Morris has pointed out that by means of this type of lifestyle elitists identified themselves with Lydia and the Orient.¹⁶⁶ Although Lydia, which paired wealth and refinement with military strength, served as the principal role model,¹⁶⁷ I would suggest that ‘internationalism’ or ‘cosmopolitanism’ – rather than ‘orientalism’ – is the keyword to characterize East Greek elite culture. To give some examples, members of the Ionian or Aiolian upper class had a liking for Karian-type shields and helmets, and swords made in Chalkis.¹⁶⁸ They campaigned as hereditary guest-friends with the Egyptian pharaoh in Nubia, and in Palestine with the Babylonians.¹⁶⁹ These regions were ‘the world’s end’, from where they would bring back all kinds of goods like ‘an ivory sword-hilt fastened with gold’ as well as stories of duels with huge giants, almost ‘five cubits tall’.¹⁷⁰ It could even happen that these elitist fighters were decorated by the pharaoh, given a city in Egypt to govern and bring back home an inscribed statue as proof of all this.¹⁷¹ In times of peace, they would go to the agora in purple garments, with elegant hairstyles and exquisite scents – ‘useless *habrosynai* (‘luxuries’) learnt from Lydia’, that were criticized sharply by Xenophanes of Kolophon in the mid-6th century.¹⁷² They were slinging cups from Teos, to play ‘the Sicilian *kottabos*’, and long for a Thracian courtesan in Egyptian Naukratis.¹⁷³ Just as male members were dressed in ‘trailing garments’, elite females walked about ‘long-robed’.¹⁷⁴ Like men, they ‘loved *habrosynē*’, such as ‘kerchieves and crimson-dyed aprons ... sent from Phokaia, precious gifts ...’, decorated slippers – ‘lovely piece of Lydian work’ – Skythian cloaks, and many-coloured *mitrai* (‘headbands’ or perhaps ‘turbans’) that ‘only just recently were brought from Sardeis to Ionia’s cities’.¹⁷⁵ For men and women alike, the hallmark of this sophisticated lifestyle was all kinds of fragrances, incense and perfumes, the same ‘as used by Kroisos’.¹⁷⁶ In this manner, they were

¹⁶⁵ Kurke 1992. As De Vos (1995, 22 f.) also stresses, aesthetic traditions, such as tastes in food, styles of clothing and definitions of physical beauty, are often used symbolically as a basis of Self and ethnic identity.

¹⁶⁶ I. Morris 2000, 178 ff.

¹⁶⁷ See e.g. Sappho frs. 16.15, 96.3, 132.4 [Voigt]; Alkaios fr. 69.2 [Voigt]; Alkman fr. 16.5 [West]; also Archil. fr. 19 [West]. For the Lydians’ luxurious lifestyle and martial valour, see also Hdt. 1.55.4, 79.2–3.

¹⁶⁸ Anakreon fr. 401 [Page] (Karian shield); Alkaios frs. 140.10, 388 [Voigt] (Chalkidian swords; Karian helmet).

¹⁶⁹ Herman 1987, 101 f. (discussing the Abu Simbel inscriptions in Nubia); also Helm 1980, 137; Haider 1996, 107 f., 114 (aristocrats).

¹⁷⁰ Alkaios fr. 350 [Voigt], relating his brother Antimenidas’ adventures in Palestine, with Bettalli 1995, 26, 43–49, 54–55, 104, 108 f. (about elite fighters).

¹⁷¹ Masson/Yoyotte 1988; also Vittmann 2003, 203–205: Egyptian ‘block statue’ reportedly found near Priene. The pharaoh in question is either Psammetichos I (c. 665–610; favoured by Haider 2001, 200 f.) or II (c. 595–589; see Pernigotti 1999, 95 f.).

¹⁷² Xenophanes fr. 3 [West]. See also Hippias of Erythrai, *FGH* 421 F 1, with Jeffery 1976, 229: tyrants of Erythrai (7th century?) copying luxurious Lydian habits, such as wearing scarlet, jewellery and false curls, and travelling in litters. On the Samians (6th century?), see *Asios ad*

Douris of Samos, FGH 76 F 60 (=Athen. 12.525f.); also Eratosthenes, *FGH* 241 F 11.

¹⁷³ Alkaios fr. 322 [Voigt] (Teian cups); Anakreon fr. 415 [Page] (‘slinging the Sicilian *kottabos*’). Rhodopis, the *hetaira*: Sappho fr. 15 [Voigt]; cf. Hdt. 2.134, 135.6; Strabo 27.1.33.

¹⁷⁴ Alkaios fr. 130b.18 [Voigt]: ἐλκεσιπεπλοι; cf. *Il.* 13.685; *Hom. hymn Ap.* 146–147 (ἐλκεχίτωνες ἰάονες), with Van Wees 2005.

¹⁷⁵ Sappho fr. 58.25 [Voigt] (ἔγω δὲ φίλημι ἄβροσύναν); cf. Anakreon fr. 373 [Page]. Sappho frs. 101; 39; 98 [Voigt] (Phokaian kerchieves; Lydian slippers; *mitrai* from Sardeis); cf. Alkman, *Partheneion* 1.67–68 (μίτρα Λυδία); Pindar, *Nem.* 8.15 (Λυδίαν μίτραν), more likely to refer to a fillet or ribbon). Skythian cloak: Hipponax fr. 2 [West].

¹⁷⁶ E.g. Sappho frs. 2.4; 44 [Voigt] (frankincense, fragrances and other luxuries); Xenophanes frs. 1, 3 [West] (perfume and frankincense; scented unguents); Alkaios frs. 50; 362 (scent; myrrh); Hipponax fr. 104.12 [West] (perfume as used by Kroisos). As J. de La Genière (1984, 91) puts it aptly: ‘si l’on écoute Aténée [XV.690b–c] en effet, le royaume de Sardes est une province importante du vaste empire des parfums qu’est aux yeux des Grecs le monde oriental’. See Gras 2000, 150 f. for further references to use and production of incense in Ionia and Aiolis.

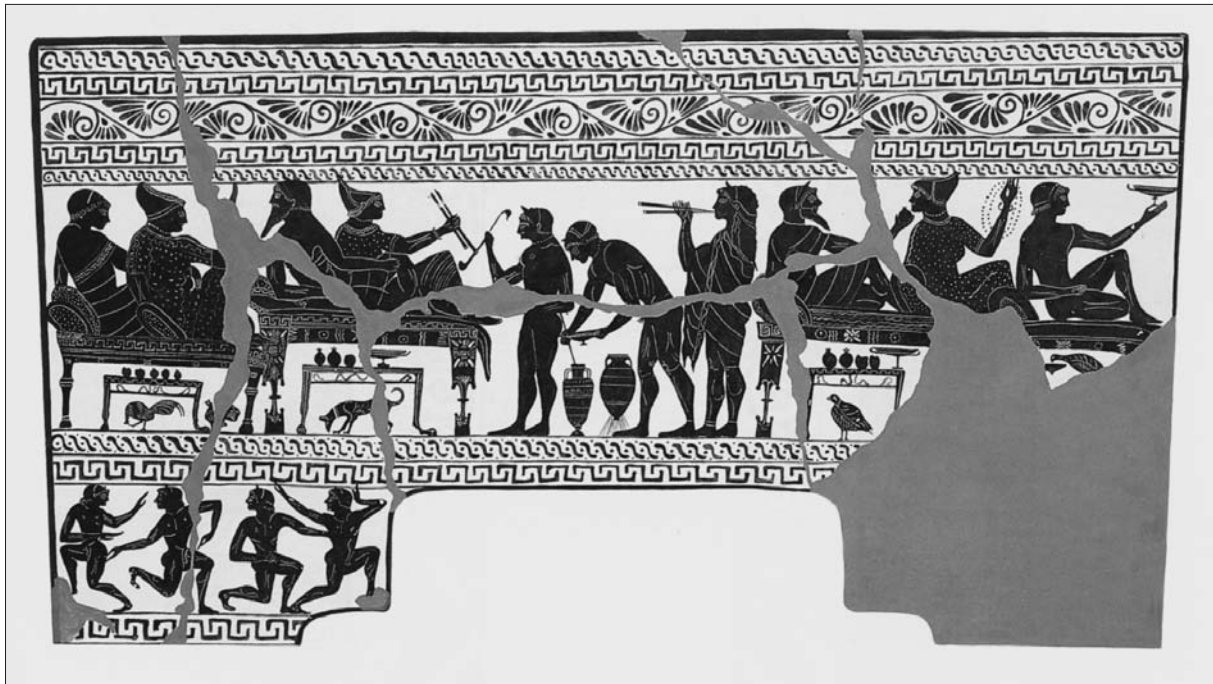

Fig. 5. Klazomenian sarcophagus found at Akanthos (Chalkidike), c. 540–500 BC (= Kaltsas 1996–1997, pl. 15).

cosmopolitans, members of an international elite: East Greeks – especially Milesians and Kolophonians – shared a life of exotic luxury with notably Lydians, Sybarites and Etruscans.¹⁷⁷ In the archaeological record we see a reflection of this lifestyle, for instance, in the wide distribution of *lydia*, unguent flasks of Lydian origin or type,¹⁷⁸ while in the representational art of this period we find, for example, symposiasts and komasts wearing Lydian turbans.¹⁷⁹ A number of these elements come together on a decorated Klazomenian sarcophagus that was discovered not very long ago at Akanthos in Chalkidike (fig. 5).¹⁸⁰ The main panel shows a symposium scene. A variety of unguent flasks can be seen standing on the side tables. Below the bed on the left side are two examples of what the ancient Greeks called the ‘Persian bird’ (cock). Some of the reclining symposiasts wear turbans of Lydian type. But perhaps the most ‘exotic’ of all is that these turbans are worn by women who are reclining together with the men. To many mainland Greeks this would be highly unusual: they would qualify the presence of women at a banquet as an eastern habit that ran counter to Greek customs.¹⁸¹

Initially, foreign contacts, a refined way of life, and love of luxury were not suspect and not considered a sign of weakness.¹⁸² Poets like Mimnermos, Alkaios and Polymnestos (another Kolophonian) embodied two types of men – the brave man fighting on the battlefield and the light one enjoying the pleasures of a sophisticated lifestyle. Martial conduct and love of luxury were two sides of the same, aristocratic

¹⁷⁷ Hdt. 6.21.1; Diod. 8.18, 20; Timaios 12.519 b (=FGH 566 F 50). For Kolophonian colonists at Siris, see Athen. 12.523c, with J. Hall 2000, 389–396, 398.

¹⁷⁸ Gras 2000, 150–155.

¹⁷⁹ E.g. Boardman 1967, 161 fig. 108: 748; 1976, 283–285; 1980, 97 f., with fig. 112; A. Lemos 2000, 389–390 figs. 277–278; also Pipili 2000, 415 f.

¹⁸⁰ Kaltsas 1996–1997, 35–50, pls. 15, 21–22.

¹⁸¹ See Hdt. 5.18.2–3. It is possible that the women depicted on the Akanthos sarcophagus are *hetairai*, although this is not made explicit by specific actions or performances; for this, cf. Kurke 1999, 184 f., 199 ff. A *hetaira* seems to be mentioned in Anakreon fr. 373 [Page]; sometimes also slave girls attended banquets, see Theogn. 1002.

¹⁸² Kurke 1992.

coin.¹⁸³ With Xenophanes' scolding the Kolophonians for submissiveness and love of luxury,¹⁸⁴ the idea was introduced that with pleasure and luxury the masculine vigour of the state had collapsed and that the East Greek cities had been punished for their *hybris*.¹⁸⁵ By the first half of the 5th century the decadence of the East Ionian cities seems to have become proverbial.¹⁸⁶ Moreover, after the Greek victory over the Persians, Greek identity was redefined on the basis of a series of oppositions between independent, courageous and self-disciplined Greeks vs. servile, unrestrained and luxury-loving easterners.¹⁸⁷ Ionia, which during the Archaic period had served as an intermediary between the exotic east and the Greek states to the west and had been subject first to the Lydians and later to the Persians, was considered to share the qualifications of easterners.¹⁸⁸ To some extent this also affected the Ionian Athenians, which may have been the reason why, if we can believe Herodotos,¹⁸⁹ many Athenians were ashamed of their Ionian ancestry. Not surprisingly, during the Peloponnesian war the Spartans eagerly used it as one of the themes in the ethnic rhetoric that was part of their political propaganda.¹⁹⁰

6 CULT: SANCTUARIES AS FOCI OF LOCAL AND SUPRA-LOCAL IDENTITIES

During a large part of the 1st millennium BC the polis was the most important form of socio-political organization on both sides of the Aegean. The polis' three main constituent parts were the city, its territory and its resident community.¹⁹¹ Authority and landownership were, at least formally, located in the citizen community as a whole. The type of constitution and the part of the polis community that performed governmental functions, however, could vary. Archaeological evidence shows that the first signs of community life can be found in the rise of formal sanctuaries and the building of temples during the 8th and 7th centuries.¹⁹² Apparently, this was a formative period in the development of the polis. The emphasis on cult and sanctuaries indicates that the community of the incipient polis regarded itself first of all as a community of cult. Literary sources from Homer onwards substantiate this picture. Communal cult including sacrifices and communal meals were an important aspect of community life. Even when members of the ruling elite fulfilled priestly functions (for instance, the Branchidai at Didyma), there was a strong sense that all citizens collectively formed a cult community and that this community as a whole

¹⁸³ Mimm. frs. 1, 9, 14 [West]; Alkaios fr. 140 [Voigt], with Huxley 1966, 81 f.; Jeffery 1976, 225; Lombardo/Frisone 2000, 207.

¹⁸⁴ Xenophanes fr. 3.4 [West]. He refers to χεῖλιοι ('a thousand'), probably Kolophonian oligarchs.

¹⁸⁵ E.g. Theogn. 1103-1104; Arist. fr. 557 [Rose]=Athen. 12.523e-f; Hippokrates, *Aer.* 16. Even earlier criticism may be found in *Il.* 2.872-873 (Karian from Miletos wearing gold [hair] ornaments, 'like a girl'); see also 17.51-52; *Od.* 11.521. The Lydians were believed to have experienced a similar sort of degeneration, see Hdt. 1.155.4, 157.2, with Kurke 1999, 168.

¹⁸⁶ Timokreon of Rhodos fr. 7=Athen. 12.523f.; also Hdt. 9.122, with Kurke 1992, 101-105; Connor 1993, 199-200.

¹⁸⁷ E. Hall 1989.

¹⁸⁸ Hdt. 1.143.2; 4.142; 5.9.1; 6.12-13.1; 8.22, with Heinrichs 1989; Corsaro 1991.

¹⁸⁹ Hdt. 5.69; but cf. Thouk. 1.6; 8.24.4.

¹⁹⁰ See e.g. Thouk. 1.124; 5.9; 6.77.1, 82; 8.25.3, with Alty 1982.

¹⁹¹ See Sakellariou 1989, 27 ff., 495. These elements are explicitly mentioned in a late Archaic inscription from Teos (see Jeffery 1976, 226 f., with Meiggs/Lewis 1969, 62-66).

¹⁹² See e.g. Artemision, Ephesos: peripteros of c. 750 - 700 (and evidence of still earlier cult building); Bammer 1990; 1991; Bammer/Muss 1996, 33-38; Mazarakis Ainian 1997, 205-207. Heraion, Samos: altar: 8th century, *hekatompedon*: 7th century; Mallwitz 1981, 624-633. More generally on this topic: Snodgrass 1980, 58-60; de Polignac 1995; Mazarakis Ainian 1997.

maintained a reciprocal relationship with its patron deities.¹⁹³ This idea is clearly expressed in a prayer to Zeus composed by Kallinos in the mid-7th century:

*Have mercy on us Smyrnaians [...]
Think of the times Smyrnaians have for thee
burned fine ox-thighbones.*¹⁹⁴

Also individual community members felt a close relationship with the community's patron deity. This is particularly well illustrated by the foundation of cults of specific polis deities in foreign lands or votive offerings made abroad to the polis deity of the individual's home town, such as 6th-century dedications 'to Milesian Apollo' and 'to Apollon Didymeus' found at Naukratis and 'to Apollon Didymeus Milesios' found at Olbia on the Black Sea.¹⁹⁵

The cult of the main patron deity was celebrated in the central polis sanctuary, which usually was located in the polis' civic centre, for example on the acropolis.¹⁹⁶ The Samian Heraion and Ephesian Artemision are exceptions to this rule. The sub-urban Artemision at Ephesos was situated at the foot of a promontory (today's Ayasuluk hill) where during the Late Bronze and Early Iron Age an important settlement nucleus was located. The story of the Lydian siege of Ephesos under Kroisos underscores the strong bond between patron goddess and city.¹⁹⁷ Next to these central polis sanctuaries, there existed important extra-urban sanctuaries that helped to strengthen the link between city and countryside and gave expression to the territorial sovereignty of the polis. Examples of such sanctuaries are the oracular sanctuary of Apollo and Artemis at Didyma (also known as Branchidai) in the territory of Miletos, and the one at Klaros near Kolophon, as well as the smaller rural sanctuaries that were scattered over the countryside.¹⁹⁸

¹⁹³ Already in Homer, see e.g. *Il.* 6.86 ff., 269ff., with Crielaard 1995, 216–217, 242–243, 253. According to Solon, Pallas Athena is 'guardian' (ἐπίσκοπος) of the polis of the Athenians (fr. 4.3 [West]), while the Athenian fatherland is referred to as 'god-founded' (Ἀθήνας πατρίδ' ἐς θεόκτιτον; fr. 36.7). Cult of Athena Poliouchos ('guardian of the polis') at Chios, see Hdt. 1.160. Artemis is 'shepherd of the citizens' of Magnesia, see Anakreon fr. 348.8 (Page). Cf. also Alkaios fr. 129.1–3 [Voigt] (c. 600):]ράα τὸδε Λέσβιοι [...]... εὐδελον τέμενος μέγα ζῦνον κά[τε]σαν, '... the Lesbians founded this great, conspicuous precinct for everybody' (=sanctuary of Zeus, Dionysos and Hera). Hera is addressed as Αἰολίαν [κ]υδαλίαν θεὸν πάντων (fr. 129.6–7), 'Aiolian goddess, proud mother of all', but the context of this poem and of Sappho fr. 17 [Voigt] makes it clear that this is not a regional, Aiolian but a local, Lesbian sanctuary; nevertheless, it may be seen as an expression of the island's Aiolian identity, as Jonathan Hall (2002, 73) points out. At the same time, this Hera 'mother of all' has distinctively Anatolian overtones (cf. Roller 1999, ch. 5).

¹⁹⁴ Kallinos fr. 2, 2a [West]. It is sometimes assumed that the Smyrnaians mentioned here are inhabitants of a neighbourhood of Ephesos named Smyrna, cf. Strabo 14.1.4; also Hipponax fr. 50 [West].

¹⁹⁵ E.g. *temenea* of Samian Hera and Milesian Apollo at Naukratis: Hdt. II.178, with Möller 2000, 94–99, 101. Dedications: Möller 2000, 176–177; Onyshkevych 2002. This is not to say that other Greeks were not making dedications to these gods (see e.g. Möller 2000, 171); see in this connection also cults of Ephesian Artemis and 'Panionian' Apollo Delphinios at Phokaian Massalia, and of Ephesian Artemis in Massalia's colony at Emporion, Spain (Strabo 4.179).

¹⁹⁶ See, for instance, in East Greece the Athena temples at Phokaia, Erythrai (Villing 1998, 154 f.) and Smyrna (Akurgal 1983, 63 ff.; Cook/Nicholls 1998).

¹⁹⁷ Cf. de Polignac 1995, 75–77. For Ephesos' ancient topography, see Kraft *et al.* 2000, esp. 182–186. Lydian siege: Hdt. 1.26. Heraion: below, 6.2.

¹⁹⁸ Didyma: *Sekos* I with *naiskos*, around basins/spring; later 8th century, enlarged *adyton* of Temple II and *Rundbau*: 7th to 6th centuries; Tuchelt 1991b, 86, 90, 95; further Fontenrose 1988; Tuchelt 1991a, 18 ff. Klaros: earlier, mixed deposits: 10th to 8th centuries, altar: c. 650 – 600, temple: mid-6th century; S. Mitchell 1990, 99 f.; 1999, 148 f. See also Simon 1997, 134–137. Rural sanctuaries: e.g. Lohmann 2007, 380 f. (Milesia).

Another phenomenon connected with the development of poleis concerns the rise of inter-state sanctuaries. These fulfilled religious functions, but were also centres of communication and competition. Located outside the control of any single major power, they were neutral meeting places of poleis and their individual members.¹⁹⁹ Religious delegations (*theoriai*) were sent there to bring votive offerings and hold communal celebrations and athletic or musical contests. It was on Delos and at Mykale that the Ionians held their *panēgyris* (religious assemblage).²⁰⁰ Archaeological evidence suggests that only in the second half of the 8th century did Delos achieve broader, supra-regional importance. The first monumental architecture dates to the 7th century.²⁰¹ Present-day Otomatik Tepe near Güzelçamlı and Kaletepe ('Melie') has been identified as the site of the Panionion at Mykale. There are traces of a large altar enclosed on three sides by a substantial terrace wall, and a council 'chamber' in the form of a theatre. The earliest human activity at the site can be attributed to the 6th century on the basis of a few early 6th-century pottery fragments.²⁰² Lohmann, however, points out that the monumental architecture belongs to the 4th century, and attributes it to a phase when the Panionia were re-installed.²⁰³ The question is then where, when and how the Archaic Panionion was established. The *Iliad* mentions the bellowing of bulls that are 'dragged' for Poseidon who is addressed as the 'Helikonion master'. If it is not Poseidon of Helike in Achaia, it may be Poseidon Helikonios of Mykale who is referred to in this simile. Considering that Homer knows Mykale as Karian territory, the poet may have had a non- or pre-Greek cult place in mind (and not necessarily the Panionion, as is sometimes assumed).²⁰⁴ Lohmann has pointed at evidence suggesting that pulling up roaring bulls was indeed an element of some cults in Asia Minor. Perhaps the cult of Poseidon Helikonios of the Panionion was a continuation of an earlier, Karian cult which was connected with Melie. As referred to earlier in section 5, Lohmann claims that he has identified what Herodotos describes as 'a consecrated spot on the north side of Mykale, chosen by common consent of the Ionians and dedicated to Poseidon Helikonios'²⁰⁵ at Çatallar Tepe on Mykale. At an altitude of 780 m he has discovered the remains of a settlement that was fortified by defensive walls built in a non-Greek fashion. Intensive surface surveys of the settlement area have yielded pottery that is confined to the 7th century. Excavations brought to light a small cult building with an offering bench and circular altar of the same period (c. 650/40-600/590 BC). On top of this, a 100-foot-long temple was erected c. 560 BC. It comprised a *pronaos*, *naos* and a room that on the basis of its lay-out can be identified as a *lesche*. This dining room contained much pottery connected with drinking, as well as spear heads and possibly shields found near the walls. Lohmann suggests that the earlier settlement was Melie, which was destroyed together with its defences and sanctuary at the end of the 7th century. The *hekatompedon* built amidst the ruins after a hiatus of some 50 years was the sanctuary of Poseidon Helikonios, with its *lesche* functioning as the council chamber of the *koionon* of the Ionian Dodekapolis.²⁰⁶ Especially the latter element is a strong point in favour of this theory. On the other hand, architectural details of the *hekatompedon* suggest that – measured by standards of contemporary Ionian architecture – it is a 'primitive' and

¹⁹⁹ Snodgrass 1980, 55 f., 60; 1986b, 54 f.; Sourvinou-Inwood 1990; Morgan 1993, esp. 18 f., 34, 36 f.; de Pignac 1994, 11 f.

²⁰⁰ In addition to that, East Greek cities had treasuries at pan-Hellenic sanctuaries, such as Delphi; cf. Hdt. 1.50.

²⁰¹ Morgan 1993, 21, 26–30; Mazarakis Ainian 1997, 45 f., 73 f. (with Blackman 2000, 116), 179–183. Ref. in Homer: *Od.* 6.162–167, with Crielaard 1995, 256 f.

²⁰² Kleiner *et al.* 1967, 22–28; also 75, 96 (pottery frs.).

²⁰³ Lohmann 2004, 36–38.

²⁰⁴ *Il.* 2.869 (Karians holding the peaks of Mykale); 20.403–

405 (Ἑλικώνιον ... ἄνακτα). According to H.T. Wade-Gery (1952, 2 f.) this is an oblique reference to the Panionia; for the Achaian connection: *Il.* 8.200–204; *Hom. hymn Pos.* 3; Paus. 7.24.4, 8.7.2; Strabo. 8.7.2, with Hdt. 1.145, 148, but cf. Lohmann 2004 for further discussion of Poseidon Helikonios and the localization of Melie and the Panionion.

²⁰⁵ Hdt. 1.148: τῆς Μυκάλης χώρος ἰρός; cf. also Diod. 15.49.

²⁰⁶ Lohmann 2004, 40 f.; Lohmann *et al.* 2007, 105 f., 129–141, 142–147 (*naiskos*), 147–157 (*hekatompedon*), 168–176 (site surveys).

‘ambivalent’ building.²⁰⁷ Somewhat problematic also is that it was destroyed by fire only some ten years after its construction, never to be rebuilt again, whereas Herodotos makes it clear that during the second half of the 6th century it still functioned as a meeting place for the Ionians.²⁰⁸ To sum up, the destruction of Melie provides a *post quem* for the installation of a common Ionian festival and sanctuary. In earlier literature this event is usually dated around 700, but this date is probably too high. As argued earlier, close scrutiny of the evidence from Kaletepe could suggest a considerably lower date,²⁰⁹ but it is doubtful whether this site can be linked to Melie. At Çatallar Tepe, which might turn out to be a better candidate, the earliest evidence we have for a common Ionian festival and sanctuary does not pre-date the first half of the 6th century.

Perhaps the establishment of the Panionion should be seen in relation to or even in opposition with the Triopion of the Asiatic Dorians. According to the tradition, the Triopion was the place where the Dorians had first landed in Asia Minor and where the Dorian Pentapolis later celebrated their joint cult of Apollo Triopios. The site of the sanctuary has recently been located on the south side of the Knidos peninsula on a promontory to the south of present-day Emecik Köy. The sanctuary may go back to the later 8th century, but building activities giving it a more ‘monumental’ look date to the later 7th or earlier 6th century.²¹⁰

We will now look in more detail at these two types of sanctuaries. The idea is that, given the centrality of cult in community life, sanctuaries can provide important information about how collective identities were perceived and defined. More in particular, we have the opportunity to examine the importance of local and supra-local identities, as well as ethnic identities and other forms of identity cross-cutting these categories. Furthermore, we will try to determine whether these various identities were marked by ‘hard’ barriers or rather by ‘soft’ boundaries.

LOCAL SANCTUARIES

Evidently, local sanctuaries were in the first place foci of local identity. They were not only centres of local cult, but also places where local memory and history were kept alive with the help of dedications, inscriptions, victory monuments etc. The indissoluble link that existed between cult places and the identity of local polis communities is illustrated, for one, by the frequent attempts warring parties made to burn down the opponent’s main sanctuaries and thus hit the other right in the heart.²¹¹ Local identity often verged on local pride and we see that already at an early stage sanctuaries became arenas of competition between local communities. Thus, during the later 8th and 7th centuries a series of unusually large, 100-foot-long temples were constructed for local patron deities at Eretria, Samos and possibly Teos, which testify to incipient peer-polity rivalry amongst the developing poleis.²¹² Later, in the mid-6th century, the colossal Ionian temple on Samos was almost immediately emulated by similar *dipteroi* at Ephesos and Didyma.²¹³

²⁰⁷ Says H. Büsing in Lohmann *et al.* 2007, 157–167.

²⁰⁸ Lohmann *et al.* 2007, 137–138, 150, 155–157. Herda (2006) argues that Çatallar Tepe is Mykalessos–Mykale with the sanctuary of Zeus Mykaleus, adhering to the traditional idea that Kaletepe is Melie/Panionion.

²⁰⁹ See above, section 5; also Cook 1960, 47; 1982a, 750.

²¹⁰ D. Berges/N. Tuna 2000a; 2000b; Berges 2002.

²¹¹ See e.g. Artemis temples at Ephesos and Magnesia destroyed by Kimmerians (Kallim., *Hymn.* 3.251–258; Athen. 12.525c); Athena temple at Phokaia and Hera temple on Samos by Persians (Paus. 7.5.2; see also Hdt. 3.147.2); Kybebe temple at Sardeis by Milesians, Athe-

nians and Eretrians in 500/499 (Hdt. 5.102; also Paus. 7.5.3); Didyma by Persians in 494 (Hdt. 6.19); temples on Athenian Acropolis in 490 by Persians (8.52, 144.2). More generally, Hdt. 6.13 and 32 but cf. 6.25.2.

²¹² The *hekatompedon* at Eretria (c. 740 – 720) is earlier than the one on Samos (c. 700), see Mazarakis Ainian 1997, 62 f., 199–202. The ashlar building on the acropolis of Teos is not precisely dated; it is just somewhat bigger than the Samian *hekatompedon*; see Tuna 1997, 220 f. See also Ephesos (late 7th/early 6th century): Bammer/Muss 1996, 44; Bammer 1998, 46.

²¹³ Hdt. 2.148; 3.60.4.

The one at Ephesos was bigger and made of marble, but when the original Samian *dipteros* was destroyed by fire later in the 6th century, an even larger temple was planned to surpass the one that was being built at Ephesos. Unquestionably, temple construction remained a vehicle of inter-state competition.²¹⁴ Another phenomenon of the 8th and especially the 7th century concerns the dedication of foreign objects in local sanctuaries. An impressive quantity and variety of such goods came to light in sanctuaries at Ephesos, Miletos and, especially, on Samos, where preservation and recovery conditions are unusually favourable.²¹⁵ Elsewhere in the Greek world such collections are found mostly in inter-state sanctuaries, such as Delphi and Olympia.²¹⁶ I suggest that a large part of these lavish dedications of foreign luxury goods – many of which are specifically related to an elite way of life – had been made by members of the local upper class to underline their special position within the local community. In a previous period tombs were the prime location for conspicuous consumption of exotica and other prestige goods.²¹⁷ However, during the 8th and 7th centuries, when sanctuaries became a new arena for social differentiation and intra-elite competition, similar categories of foreign goods were deposited at cult sites.²¹⁸ At the same time, the accumulation of exotica in local sanctuaries was part of status competition between peer communities. Clearly, sanctuaries were important places to express elite identity, but this happened partly within the context of the local community.

It is likely that, in addition to members of local elites, foreign visitors made exotic dedications and sacrifices.²¹⁹ Foreign rulers, such as Kroisos of Lydia and the Egyptian pharaohs Necho II and Amasis, sent personal items as dedications to Didyma, Ephesos and Samos. Kroisos also sponsored the construction of the Archaic Artemision at Ephesos.²²⁰ This shows that sanctuaries were places of ‘mediation’,²²¹ viz. localities where relationships with the outside world were materialized. It is also clear that by having access to local polis sanctuaries, foreigners in fact had access to the heart of the Ionian poleis.

References to the world beyond are also found in the design of some of these sanctuaries. Early cult buildings in the Artemision at Ephesos and the Heraion on Delos were possibly inspired by Near Eastern prototypes.²²² Intercommunication with the wider world found a particularly clear expression in the new layout of a number of sanctuaries in the course of the 6th century. Egyptian inspiration is detectable in the colossal marble *kouroi* (on Samos and Delos, and at Klaros), seated temple officials and other figures (Samos and Didyma), and rows of couching lions and sphinxes (Didyma and Delos).²²³ The practice of lining the

²¹⁴ Snodgrass 1986, 56; also Tölle-Kastenbein 1994, 41–76. Ephesos: Bammer/Muss 1996, 42–53. Didyma, Temple II: Schattner 1996, 1–23; Schneider 1996.

²¹⁵ Ephesos, Artemision: Hogarth 1908, esp. pls. 21–27, 43–48; Bammer 1990, 150–153; Bammer/Muss 1996, 30–32, 73–90. Miletos, Athena temple: Hölbl 1999, 345–347; Held 2000, 127–137, 167–177. Samos, Heraion: Kilian-Dirlmeier 1985, esp. 235 ff., 248 ff.; Brize 1997. Smaller quantities of exotic goods at Smyrna (Akurgal 1983, pls. 130–136) and Emporio on Chios (Boardman 1967, esp. pls. 87–91, 95–96).

²¹⁶ It is entirely possible that the Samian Heraion fulfilled supra-local and even ‘international’ functions; on the other hand, the sacred road (not later than the early 6th century) leading to the city of Samos forms the materialization of the link that existed between city and sanctuary.

²¹⁷ See e.g. Crielaard 1998a; 2006.

²¹⁸ Cf. de Polignac 1996; Crielaard 1998b. At Samos, for

one, especially various horse-related items and weapons (including exotic specimens) can be considered as votives dedicated by members of the elite.

²¹⁹ Bammer 1985b, 103–108; Bammer/Muss 1996, 84–86: Phoenicians.

²²⁰ Gifts from foreign rulers: Hdt. 1.92; 2.159.3, 182; see also 3.40 ff., 47; 5.36.2–4. Artemision: Hdt. 1.192; *columnae caelatae* etc.: Bammer/Muss 1996, 42–53; also Bammer 1990, 142–144. Cf. Hdt. 1.22.4: Alyattes and Athena temples at Assesos.

²²¹ De Polignac 1994.

²²² Mazarakis Ainian 1997, 278; but cf. Bammer/Muss 1996, 88: Kretan inspiration.

²²³ Colossal *kouroi*: see e.g. Kyrieleis 1996; Haider 1996, 113; S. Mitchell 1999, 149. Seated statues: e.g. Tuchelt 1970, 71–93; 1991b, 91–94; Höckmann 1996; Kopanias 2001. Lions: Haider 1996, 112. More general: Guralnick 1997, esp. 137.

sacred way up to the temple with long rows of such statues was also a clear example of Greek sanctuaries seeking to emulate the great temple precincts of Egypt.²²⁴ Votives from Samos and Ephesos reveal a Kretan connection, while a certain class of ‘*kouroi*’ and ‘*korai*’ from Samos testify to a close link with Cyprus.²²⁵ Apparently, the East Ionian cities wished to put their sanctuaries on a par with those of Egypt and the Near East.

There is one more interesting aspect about ‘foreign’ elements in cult and sanctuaries: their links with the Anatolian milieu. A number of East Ionian cities housed cults of Syro-Phrygian Kubaba/Kybele (e.g. in Chios, Phokaia and Ephesos)²²⁶ or cults of goddesses that otherwise display Anatolian traits.²²⁷ The oracles at Klaros and Didyma most probably had Anatolian roots, and the same seems to apply to Hera’s cult on Samos.²²⁸ As for Didyma, the place name, the name of the clan or association of temple officials called Branchidai (from Βράγχος or Βάραγχος), the layout and nature of the earliest sanctuary and the non-Greek character of the animal sacrifices all point to a Karian origin of this cult site.²²⁹ As archaeology suggests, the cult may have started to function only during the 8th century. In the course of the second half of the 6th century, possibly under tyrannical rule, a number of cult sites in Miletos and on the Milesian peninsula underwent large-scale remodelling. This included the construction of the sacred road linking Miletos and Didyma. Halfway between the two places and overlooking the sacred road, a cult site of an aristocratic clan was founded. This sacred road and the annual procession from the Delphinion (the central polis sanctuary) to Didyma embedded the ‘Karian’ sanctuary even more firmly in the cultic infrastructure of the Milesian polis.²³⁰

SUPRA-LOCAL SANCTUARIES

The interstate sanctuary of Apollo on Delos held special importance for the supra-local, collective identity of the Ionians, as made clear by a passage in the *Homeric Hymn to Apollo*:

*Many temples and wooded groves are yours [. . .]
But it is in Delos, O Phoibos, that your heart delights the most,
for Ionians with trailing garments gather there
in your honour, together with their children and modest wives.
And with boxing matches, dancing and song,
they delight you and remember you whenever they hold the contests.*²³¹

²²⁴ Tuchelt 1970, 93–98; also 1991a, 38 ff., 44 ff.; Boardman 1980, 144.

²²⁵ Kretan connection: Bammer 1991–’92, 19–26; Bammer/Muss 1996, 87 f.; Lembesi 1999. Cypriot link: Schmidt 1968; Bammer 1972, 720 (Ephesos). See now also Karageorghis 2002.

²²⁶ Boardman 1980, 93 f.; Naumann 1983; S. Mitchell 1999, 143; Roller 1999, esp. Ch. 5; Soykal 2002, 274 f.; also Hanfmann 1983a, 90–96, 128–136. Cf. Hipponax fr. 127 [West]: Κυβήβη.

²²⁷ See e.g. Cook 1958–1959, 12 note 4; Jeffery 1964, 39 (Artemis at Smyrna); Mellink 1981/1983 (Hera of Samos, Artemis of Ephesos); Bammer 1985a; 1985b, 107 f. (Artemis of Ephesos); Villing 1998, 154–159 (Athena at Erythrai); Parke 1988, 51–70 (Sibyls at Erythrai, Ephesos

and Samos, who – like the one at Sardeis – were possibly of Phrygian origin).

²²⁸ Parke 1985; also Ohly 1953, 77–83, esp. 82 (Samos).

²²⁹ Fontenrose 1988, 3–5, 77 f., 172; Tuchelt 1988, 432; 1991b, 86, 90, 95–98; Ehrhardt 2006, 85 f. Branchidai: also Graf 1985, 104; Ehrhardt 1998, 15, 19. Βάραγχος: Hipponax fr. 105 [West]. Animal (incl. dog) sacrifices: Tuchelt 1992, with refs. Also at Ephesos: Bammer 1985b, 106, with note 21; Bammer/Muss 1996, 81; cf. Bammer 1998, 38–40; Hägg 1998, 50, 52, 54.

²³⁰ Ehrhardt 1998, 11–20; Niemeier 1999b, 396–409. Both authors argue against K. Tuchelt’s earlier view (1988, 430–433; 1991b, 91–96) that Didyma for a long time was independent from Miletos. Aristocratic cult site: see now also Tuchelt 1991a, 40 ff.; Tuchelt *et al.* 1996.

Here, the Ionians are identified as a religious group. A second passage underlines the special relationship between Apollo and Delos (the god's birthplace), in opposition to Apollo sanctuaries in individual cities and neighbouring non-Greek communities:

*O Lord, yours is Lykia and lovely Maionia [i.e. Lydia]
and Miletos, too, enchanting city by the sea,
but over wave-girt Delos you greatly reign your own self.*²³²

The writer of the *Hymn to Apollo* – or at least of its first, Delian part – claims to be a native of Chios.²³³ His outlook is Aegean.²³⁴ A catalogue that begins as a survey of Apollo's worshippers covers the Aegean and its shores, with special emphasis on the eastern side.²³⁵ The Apollo sanctuary on Delos probably catered for a relatively large region. Thουκυδίδης, who quotes passages from the hymn, tells us that in the old days 'the Ionians and the neighbouring islanders used to come to the festival at Delos'.²³⁶ Pottery brought by votaries during the 8th to 6th centuries confirms that the island sanctuary attracted visitors especially from the Kyklades, the eastern Aegean islands, the coast of Asia Minor and, to a lesser extent, Euboiia and Attika.²³⁷ There is a tradition that Messenians sent sacrifices to Apollo at Delos with a chorus of men, singing a Prosodion, a processional hymn composed by the Korinthian poet Eumelos.²³⁸ Moreover, according to the *Hymn to Apollo* the so-called Delian maidens, after singing hymns to the gods and heroes, skilfully mimicked 'the tongues of all men and their clattering speech'.²³⁹ These were probably the various local dialects and perhaps also the non-Greek languages of pilgrims coming to Delos.²⁴⁰ This implies that the sanctuary attracted visitors from a much wider variety of regions. The message of the above passage in the *Hymn to Apollo* can thus be summarized as follows: of all places sacred to Apollo, Delos is dearest to the god, while of all who visit this most revered sanctuary, the Ionians are closest to him.

By means of their special relationship to Delian Apollo that is proclaimed in this hymn, the Ionians define themselves as a supra-local community of cult. In this connection we may note that no reference is made to aspects of a collective identity that we may label as strictly 'ethnic'. Among the things that the gathered Ionians have in common, apart from religious ties, are a shared lifestyle and a 'proximity' to the deity that gives them a god-like appearance.²⁴¹ These things find expression in their way of dressing and in such activities as boxing, dancing and singing. Moreover, we are told that whoever sees the grace of the 'fair-girded women and the men with their swift ships and many possessions', 'might think that they were forever immortal and ageless'.²⁴² These lines constitute important testimony of Ionian self-perception in

²³¹ *Hom. hymn Ap.* 143, 146–150; cf. 19–25, 79–89. Transl. Athanassakis 1976.

²³² *Hom. hymn Ap.* 179–181. West (1974, 167 f.) places 179–180 in between lines 143 and 146 quoted above.

²³³ *Hom. hymn Ap.* 172.

²³⁴ See esp. *Hom. hymn Ap.* 141–142, also 20–24.

²³⁵ *Hom. hymn Ap.* 30–44.

²³⁶ Thουκ. 3.104.3–6; the passages quoted are *Hom. hymn Ap.* 146–150, 165–172. Cf. Pindar's *Paian* (5), for Delian Apollo (52e); Hdt. 4.35.3; Diod. 15.49.1. Thουκυδίδης adds that in his day (late 5th century) the Ionians – probably those living in Asia Minor – celebrate their festival in Ephesos; adversity was responsible for the waning of the festival.

²³⁷ Dugas 1928; 1935; Dugas/Rhomaïos 1934; Zaphiropou-

lou 2003; further Coldstream 1977, 213–216. There are also Korinthian imports. For links with the Kyklades and Attika, see further Tausend 1992, 47–55.

²³⁸ Paus. 4.4.1, 33.2.

²³⁹ *Hom. hymn Ap.* 158–164.

²⁴⁰ It has been suggested that the 'babble' of the Maidens referred to Anatolian cult songs. For a discussion of this and other interpretations, see Clay 1989, 50, with note 102.

²⁴¹ Cf. Niles 1979, 39; Clay 1989, 47.

²⁴² *Hom. hymn Ap.* 153–155. With respect to 'grace', mentioned in line 153, L. Kurke (1999, 292) concludes that 'grace (χάρις) was the highest virtue of aristocratic style, denoting the perfection of bodily form and movement, the numinous value bestowed on *agalmata*, the radiant circuit of gift exchange, and the pleasures of festivity'.

the Archaic period. It concerns a lifestyle that typifies a leisure class; also the link that is made between wealth and a god-like appearance stems from a typically aristocratic ideology. At the same time, as we saw earlier, it was the aspect of wealth and luxury that later sources tended to label as typically Ionian.²⁴³ Thus, being an aristocrat and being an Ionian were in part overlapping categories. Those who gathered on Delos came not only to worship their god Apollo, but also to celebrate their Ionian, elitist identity.

Whereas the Apollo sanctuary on Delos probably catered for a wider, basically Ionian-speaking region, the Panionion on Mykale with its cult of Poseidon Helikonios was a supra-local sanctuary that served more or less exclusively the Ionian cities of the eastern Aegean. As noted earlier, there are some parallels with the Dorian Triopion. According to Herodotos,²⁴⁴ the Dorians were careful to exclude their neighbours from the use of their sanctuary, which underlines the importance of the Triopion for Dorian identity. Similarly, the Panionion was the expression in religious form of the unity of *the* Ionians, as they seem to have considered themselves (see section 1: 'Introduction'). Herodotos raises protests against this claim, which he felt was an unjustified assumption of a name common to a much wider group²⁴⁵ that must have included islanders, Athenians and cities like Smyrna, which was not even allowed access to the Panionion, since its application had been rejected.²⁴⁶

It was at Mykale that the 'koinon of the Ionians' came together.²⁴⁷ Earlier scholars tended to give much weight to the political function of the league, but Carl Roebuck convincingly argued that the league of the 6th century was primarily of a religious nature. From a political and military point of view, it was a loose federation of autonomous states with very rudimentarily developed political institutions. At the time of the attacks by the Lydian kings Gyges and Alyattes, common action was evidently still absent. It seems likely that under pressure of Persian aggression the Panionion started to fulfil political functions, but that the league became a closer unit only during the Ionian revolt.²⁴⁸ It may be noted that not all East Ionian states cooperated in this confederation. Miletos,²⁴⁹ the island states of Samos and Chios²⁵⁰ and possibly also Kolophon did not cooperate for opportunistic reasons.

As a last example of supra-local sanctuaries, we may briefly discuss the sanctuaries that Greeks held in common in their settlement at Naukratis in the Nile Delta of Egypt.²⁵¹ The Egyptian pharaoh (Herodotos names Amasis of the mid-6th century) granted them land upon which the Greeks who did not want to live permanently in Egypt might erect altars and temples. The largest, most used and best known sanctuary was the Hellênion (the 'Hellènes' sanctuary'), founded by 'Ionians of Chios, Teos, Phokaia and Klazomenai, Dorians of Rhodos, Knidos, Halikarnassos and Phaselis, and Aiolians of Mytilene'. Aiginetans built a temple of Zeus separately, the Samians one of Hera, and the Milesians one of Apollo.²⁵² Apart from Aigina, these were all East Greek cities. Vase dedications name several deities, the most telling in this respect being simply 'to the gods of the Hellènes'.²⁵³ The term Hellênion could suggest that

²⁴³ Samian nobles attending the Heraion are described in a much similar way by the Archaic Samian poet Asios, quoted in Athen. 12.525 f. (also above, note 172).

²⁴⁴ Hdt. 1.144, also 174.

²⁴⁵ Note that in spite of his protests Herodotos himself often uses 'Ionians' without the adjective 'Asiatic' or 'eastern'. This in contrast to his use of Dorians, see Hdt. 1.6: 'Ionian, Aiolians and *Asiatic* Dorians' (emphasis added).

²⁴⁶ See Hdt. 1.143.3; further 1.141.4-143, 147, with Roebuck 1955, 26 with note 7. For a possible explanation for Smyrna's refusal, see Strabo 14.1.37, with Cobet 1997, 258; Smyrna was destroyed c. 600 BC, see Cook 1985. A parallel case may be Magnesia on the Maiandros, see

Anakreon fr. 348 [Page]; Hdt. 1.161; Arist. *Pol.* 4.3.1-2; Athen. 12.525c; Strabo 14.1.40; Zenobios 3.88.

²⁴⁷ Five times between 546 and 494 BC: Hdt. 1.143, 148; also 5.109.3; cf. Roebuck 1955, 27.

²⁴⁸ Roebuck 1955, 30, 55 f.; also Tausend 1992, 90-95; cf. Murray 1988, 480 f.

²⁴⁹ Hdt. 1.141.4.

²⁵⁰ Hdt. 1.155-160.

²⁵¹ Boardman 1980, 117-132; Sullivan 1996; Pernigotti 1999; Möller 2000, esp. 75-113.

²⁵² Hdt. 2.178.

²⁵³ Boardman 1980, 120; Wachter 2001, 215 (L); Möller 2000, 177, 238 f.

being ‘Greek’ was the common basis on which these states operated together. Apparently, the Egyptian environment stimulated a precocious sense of Hellenic identity (ironically, the temple itself – if identified correctly – bears strong Egyptian influence).²⁵⁴ This sense of ‘Hellenicity’ on the part of Greeks who remained in Egypt for only a limited time stood in contrast to the mixed identity of Greeks who settled in Egypt on a permanent basis and became rapidly Egyptianized.²⁵⁵ Of the poleis that had established separate temples, probably already before the Hellēnion, Samos and Miletos honoured their respective patron deities. But even here polis pride or ethnic distinction did not create impermeable borders: epigraphic evidence shows that inhabitants of Dorian Knidos were making sacrifices ‘to Milesian Apollo’.²⁵⁶

To conclude this section, our data relating to cult and sanctuaries suggest that local identity was the most strongly articulated form of collective identity. Supra-local, Ionian identity (tainted with aristocratic sentiments) played a role, especially on Delos. At Mykale a selection of the larger Ionian community gathered. These were the Ionian cities of the eastern Aegean, which suggest that regional interests were important next to ethnic relationships. There was rivalry and competition at the level of local communities and, within these local communities, at the level of local elites. It is significant that at both levels the means that were employed to compete with were often sought outside the sphere of the own locality or region (‘exotic’ votive offerings, emulation of foreign cult sites). On the one hand, sanctuaries were important foci of local and supra-local identities. On the other hand, access to them was not restricted to community members: outsiders could underline their bonds with the sanctuary and its community. ‘Insiders’ made efforts to underscore their links with the wider world outside their own community. Sanctuaries were not introspective and introverted places, and their communities do not seem to have felt that collective identity and ‘foreignness’ were incompatible. Cult was interconnected with local or regional identities, but cult was also a domain of cultural fusion and, in specific cases, of accommodation (for instance, Lydian kings building temples at Assesos and Ephesos). In short, both local polis identity and supra-local Ionian identity seem to have been marked by ‘soft’, permeable borders.

7 SUMMARY AND CONCLUDING REMARKS

We have seen that the ethnonym ‘Ionian’ was in use already in the Late Bronze Age, although we do not know where exactly we should locate the Ionians mentioned. The Ionians who occur in the literary sources of the 8th to early 6th centuries seem to have lived mainly on the west side of the Aegean (Euboia, Attika) and on the Aegean islands (basically the Kyklades). Interestingly, the earliest references to ethnic categories and their subdivisions seem to relate to military divisions (*i-ja-wo-ne* on Knossian Linear B tablets, *Iaones* in *Iliad* XIII; also Tyrtaios’ mention of the three Dorian tribes). It is also on the west side of the Aegean that we find the first traces of an embryonic Ionian origin myth, which may have fostered some sense of ethnic affiliation based on shared ancestry. If we look at the other side of the Aegean, we see that since the Late Bronze Age Greek-speaking populations must have lived there, together with Anatolian elements and later joined by newcomers from the islands or mainland Greece. It is uncertain when the inhabitants began to refer to themselves as Ionians; the first possible attestation of *Ioniē* designating this region dates to the later 7th century.

²⁵⁴ Plan and description: Möller 2000, 107. H. Bowden (1996, 22–24) doubts the identification. Naukratis’ importance for Hellenicity, see J. Hall 1997, 49 f.; 2002, 130; L. Mitchell 2007, 56 f., 64.

²⁵⁵ Cf. Vittmann 2003, 203, 226 ff., 240. For ‘hellenized’

Karians in Egypt: *ibid.*, 228–229; Egyptianized Karians in Egypt: *ibid.*, 155 ff.; Karo-Egyptians in Babylonia: Waerzeggers 2006.

²⁵⁶ Jeffery 1990, 352, 357 (32; mid-6th century?); also Möller 2000, 171.

It may be clear that the historical evidence is insufficient to provide a straightforward answer to the question when Ionian identity came into existence and on what exactly it was based on. This problem can be partly circumvented, however, by looking at indications of various forms of collective identities and awareness of supra-local unity in more general terms. Both archaeological and literary evidence suggest that in 8th- and 7th-century Ionia, local identity was the most strongly articulated form of collective identity; a sense of supra-local or supra-regional unity seems to have been a distinctly later development. In the sphere of religion and cult, which in this period constitutes a major cohesive factor, we observe first a proliferation of sanctuaries that housed local cults, and only somewhat later we witness the rise of inter-state sanctuaries that provided a potential setting for celebrating supra-local identities. One of these sanctuaries was Delos, which developed into a meeting place for worshippers from mainly the Kyklades and the eastern Aegean during the late 8th and especially the 7th century. The *Homeric Hymn to Apollo* of the second half of the 6th century expresses the special relationship that existed between Apollo, Delos and the Ionians, and identifies the Ionians as a supra-regional community of cult. In Asia Minor itself, the Panionion at Mykale served as a supra-local or regional sanctuary of Poseidon Helikonios; there are no compelling reasons to think that this started before the 6th century. The Panionion can be regarded as an expression of a nascent collective Ionian identity. On the other hand, we should bear in mind that despite its name it was not held in common by all Ionians, but was confined to the Ionians of Asia Minor and the eastern Aegean; the Panionian *koinon* that met there, in its turn, did not include all eastern Ionians but was limited to twelve member cities. This would suggest that regional interests came before ethnic unity.

War and warlike behaviour present a similar picture. War, first of all, helped to shape local identity; it fostered solidarity among polis members and served as a means to acquire individual honour and valour within the context of the polis community. At the same time, changing constellations of allies and adversaries will have created some sense of unity at a regional level. The Meliac war, possibly datable to the late 7th century, provides evidence of common (Ionian) military action. The story of this war acted as a sort of charter myth for the establishment of the Panionion. Typically, until the Ionian revolt of 500 – 494 BC the *koinon* of the Ionians remained a religious rather than a military union.

Considering origin myths, which served as an important medium to substantiate collective identity, we observe the recording of local histories during the 7th and 6th centuries that combined myth, migration stories and episodes from the more recent past. It was only in the later 6th or the 5th century that ‘regional histories’ were composed bringing together traditions of several local communities; it is probably also at this stage that a collective (Ionian) migration story was created. These ‘regional histories’ can be considered as a sign of developing awareness of a supra-local, Ionian identity.

In addition to the above forms of collective identity, there is the strong sense of elite identity that existed among members of the local upper classes. This was manifest especially in a lifestyle that combined martial attitudes and love of luxury. Lavish dedications and elaborate ceremonial show that sanctuaries – both local and regional ones – were important arenas for display. On the basis of the description of the Ionians in the *Homeric Hymn to Apollo*, it can be argued that in the 6th century Ionian identity was interwoven with elite identity. What is more, elite identity clearly had two faces. Members of the local upper class saw themselves as the main representatives of the polis. At the same time, elitist culture was strongly internationally oriented: members of the elite placed themselves, as it were, above the polis community by advertising themselves as the cosmopolitan members of an ‘international’ elite. After c. 500 BC this elitist lifestyle became suspect.

Taking these various sorts of evidence together, we may conclude that the development of supra-local unity and a collective Ionian identity was a slow process that became more salient during the 6th century and gained momentum around 500 BC. Still, potential ethnic indicia such as language, dialect and script were probably not very important for identity. Likewise, although cult may have been interconnected with local or regional self-awareness, it was also a domain of cultural fusion, as evidenced by ‘exotic’ votive offerings and emulation of foreign cult sites. In short, both local polis identity and supra-

local Ionian identity seem to have been marked by ‘soft’, permeable borders. Conscious references to the world outside create the impression that the mechanism of self-definition and the approach towards other cultures was aggregative rather than oppositional.²⁵⁷

In much of this the East Ionians differed from both the Dorians of the Greek mainland and the Ionians of Athens. Already in the mid-7th century the Dorians possessed an elaborated *Ursprungsmythos* stressing blood ties and a shared migratory history. Probably not much later, the Athenian Ionians were occupied with the construction of an ethnic identity that emphasised autochthony.²⁵⁸ Under the influence of democracy in the 5th century this aspect was further elaborated in order to give – I should like to suggest – the *demos* as a whole a collective history, which, on top of that, could compete with the origin myths of the Dorians who ‘had been constantly on the move’²⁵⁹ and were therefore qualified as less ancient. If we try to answer the question why in East Greece collective identity followed a different track, an obvious explanation would be the Anatolian milieu and proximity of non-Ionian and non-Greek neighbours. Especially in local cults we observe a juxtaposition or fusion of ‘Greek’ and ‘Anatolian’ elements (as far as it is relevant to make such a distinction in this period and region). This is important, since cult was strongly intertwined with the identity of the community. Apart from cult and religion, the East Ionians and their Anatolian neighbours were bound together by some linguistic interconnections and a shared material culture.²⁶⁰ In such a milieu, emphasis on autochthony or on sharply defined ethnic boundaries was out of the question. This was even more so thanks to the intercommunications that existed with these non-Greek neighbours as well as with foreigners in more distant regions. These intercommunications were fostered by the strong aristocratic culture in this part of the Greek world. Within this aristocratic culture there was place for both peaceful contacts and violent confrontations, as is most clearly shown by the example of the Lydians who were both enemies and role models.²⁶¹ Besides, these local aristocrats who saw themselves as members of an ‘international’ elite did not feel bounded by ethnic borderlines neither in a cultural or political sense. As an example we may take Alkaios of Mytilene – though not an Ionian, his case illustrates the point very well. He belonged to an established land-owning family. In his struggles with the popular leaders, he regularly shifted alliances with others of his class, and at one point even with Lydia.²⁶² Clearly, the imperial policy of the Lydians and, more generally, the exposure to populations that had a different linguistic, cultural and historical background did not result in a greater awareness of Ionian identity; on the contrary, it seems to have prevented such a development.

The Persian conquest of Asia Minor changed things dramatically. It is generally acknowledged that due to contacts and conflicts with the Persians in the decades around 500 BC the Greeks developed a sense of separateness, self-awareness and superiority. Therefore, the Persian wars form a watershed in the genesis of ethnic self-consciousness and even straightforward hellenocentrism.²⁶³ After the Greek victory over the Persians, Greek identity was defined in opposition to a series of generalizations that were supposed to characterize easterners. Ionia, which during the Archaic period had served as an intermediary between the exotic east and the Greek states to the west and had been subject first to the Lydians and

²⁵⁷ Cf. J. Hall 1997, 40–51.

²⁵⁸ See J. Hall 1997, 56; Thomas 2001, 218, with further references in note 20.

²⁵⁹ Hdt. 1.56.2; cf. also Thouk. 1.2; Plato, *Mx* 245d.

²⁶⁰ General: Özgen/Öztürk 1996. Cult: e.g. Hanfmann 1983b; Mellink 1983. Architecture: e.g. Bingöl 1981/1983; Hanfmann 1981/1983. Tombs: e.g. cf. Kasper 1976–1977, with S. Mitchell 1999, 145 f.; Boardman 2002, 56. Coin-

age: see e.g. Schaps 2004, 93 ff. Elite intermarriages: Hdt. 1.92; Nic. Damasc. *FGH* 90 F 63; Aelian *VH* 3.26; Polyain. *Strat.* 6.50; cf. Sappho fr. 96 [Voigt].

²⁶¹ Cf. Georges 1994, 22–46.

²⁶² Alkaios fr. D 11 [Page].

²⁶³ E. Hall 1989; Coleman 1997; L. Mitchell 2007; also Murray 1988, 461; Gehrke, this volume.

later the Persians, was considered to share these qualifications.²⁶⁴ In the aftermath of the Persian wars, political tension between Sparta and Athens increased. Not only was Ionian identity redefined in oppositional terms (Ionians vs. Dorians²⁶⁵), but there was a clash of identities between the Ionians of Athens and the Ionians of Asia Minor. In order to legitimize her leading role in the first Delian–Attic League (and substantiate her claims on the eastern Aegean in reaction to Persia’s presence in the region), Athens seems to have appropriated the myth of the Ionian migration, claiming to be the most Ionian city of all and to be the metropolis of all Ionians.²⁶⁶ The East Ionians whose Ionian identity was contested,²⁶⁷ seem to have fought back by means of a rigorous revision of the tradition. By interweaving their common history with that of the Attic Ionians they could claim that they were at least as pure Ionian as the Athenians were. This version of the story gave some Asiatic Ionians the opportunity to claim to be of ‘the best born of the Ionians’. It is probably against this background that we should see Herodotos’ remarks about different claims on purity of Ionian descent with which we began this paper.

ABBREVIATIONS

<i>AA</i>	<i>Archäologischer Anzeiger</i>
<i>AJA</i>	<i>American Journal of Archaeology</i>
<i>AnatSt</i>	<i>Anatolian Studies</i>
<i>AR</i>	<i>Archaeological Reports</i>
<i>BSA</i>	<i>Annual of the British School of Archaeology at Athens</i>
<i>CAH</i>	<i>Cambridge Ancient History</i>
<i>FGH</i>	Jacoby, F., 1923– : <i>Fragmente der griechischen Historiker</i> , Berlin.
<i>IstMitt</i>	<i>Istanbuler Mitteilungen</i>
<i>JHS</i>	<i>Journal of Hellenic Studies</i>
<i>ÖJh</i>	<i>Jahreshefte des Österreichischen archäologischen Instituts in Wien</i>

REFERENCES

- Akurgal, E., 1983: *Alt-Smyrna I. Wohnschichten und Athenatempel*, Ankara.
- Alty, J., 1982: Dorians and Ionians, *JHS* 102, 1–14.
- Athanassakis, A.N., 1976: *The Homeric Hymns. Transl., introd., and notes*, Baltimore.
- Aytaçlar, N., 2004: The Early Iron Age at Klazomenai, in A. Moustaka *et al.* (eds), *Klazomenai, Teos and Abdera: Metropoleis and Colony. Proceedings of the international symposium held at the Archaeological Museum of Abdera (October 2001)*, Thessaloniki, 17–41.
- Bakır, T./H.W.A.M. Sancisi-Weerdenburg (eds), 2001: *Achaemenid Anatolia. Proceedings of the first international symposium on Anatolia in the Achaemenid period, Bandırma, 1997*, Istanbul/Leiden.
- Balcer, J.M., 1984: *Sparda by the bitter sea. Imperial interactions in western Anatolia*, Chico.

²⁶⁴ Cf. Thouk. 6.82. East Greek material culture borrowed not only from the Lydians, but also from the Persians, see e.g. Cahill 1988; Ratté 1992 (tomb architecture); contributions in Bakır/Sancisi-Weerdenburg 2001.

²⁶⁵ See e.g. Thouk. 1.6.3–4, 95.1, 124.1; 2.36.1; 3.86.3; 5.9.1; 6.6.1, 76.2, 82.2; 7.5.4, 57; also Jeffery 1990, 296 note 39 (sacral law from Paros). In the 5th century the adjectives

‘Ionian’ and ‘Dorian’ describe different types of music, dress and possibly architecture, see Alty 1982, 2 f. note 11, for references; also Geddes 1987.

²⁶⁶ Cf. Hdt. 9.106; Thouk. 1.2.6, 12.4; 6.82.4.

²⁶⁷ As was their contribution to the Persian wars, see Thomas 2004.

- Bammer, A., 1972: Neue Forschungen am Altar des Artemisions von Ephesos, *AA*, 714-728.
- Bammer, A., 1985a: Neue weibliche Statuetten aus dem Artemision von Ephesos, *ÖJh* 56, 39-58.
- Bammer, A., 1985b: Spuren der Phöniker im Artemision von Ephesos, *AnatSt* 35, 103-108.
- Bammer, A., 1990: A *peripteros* of the Geometric period in the Artemision of Ephesos, *AnatSt* 40, 137-160.
- Bammer, A., 1991: Les sanctuaires des VIIIe et VIIe siècles à l'Artémision d'Éphèse, *Revue archéologique*, 63-84.
- Bammer, A., 1991-'92: Multikulturelle Aspekte der frühen Kunst im Artemision von Ephesos, *ÖJh – Beiblatt* 61, 17-54.
- Bammer, A., 1998: Sanctuaries in the Artemision of Ephesos, in R. Hägg (ed.), *Ancient Greek cult practice from the archaeological evidence. Proceedings of the fourth international seminar on ancient Greek cult, organized by the Swedish Institute at Athens, 22-24 October 1993*, Stockholm, 27-47.
- Bammer, A./U. Muss, 1996: *Das Artemision von Ephesos*, Mainz am Rhein.
- Barth, F., 1969: *Ethnic groups and boundaries*, London.
- Bartoněk, A., 1979: Greek dialects between 1000 and 300 BC, *Studi micenei ed egeo-anatolici* 20, 113-130.
- Bean, G.E. /J.M. Cook, 1955: The Halicarnassus peninsula, *BSA* 50, 85-171.
- Berges, D. 2002: Archaische Funde aus Alt-Knidos, *IstMitt* 52, 99-164.
- Berges, D./N. Tuna, 2000a: Das Apolloheiligtum von Emecik. Bericht über die Ausgrabungen 1998 und 1999, *IstMitt* 50, 171-214.
- Berges, D. /N. Tuna, 2000b: Kult-, Wettkampf- und politische Versammlungsstätte. Das Triopion – Bundesheiligtum der dorischen Pentapolis, *Antike Welt* 35, 155-166.
- Bettalli, M. J., 1995: *I mercenari nel mondo Greco I. Dalle origine alla fine del V sec. a. C.*, Pisa.
- Bingöl, O., 1981/1983: Zu den Columnae Caelatae, in C. Bayburtluoğlu (ed.), *Akurgal'a Armağan/Festschrift Akurgal (Anadolu/Anatolia 22)*, 115-126.
- Blackman, D., 2000: Archaeology in Greece 1999-2000, *AR* 46, 3-151.
- Boardman, J., 1967: *Excavations in Chios 1952-1955. Greek Emporio*, Athens.
- Boardman, J., 1976: A curious eye cup, *AA*, 281-290.
- Boardman, J., 1980: *The Greeks overseas. Their early colonies and trade*, London.
- Boardman, J., 2002: *The archaeology of nostalgia. How the Greeks re-created their mythical past*, London.
- Bowden, H., 1996: The Greek settlement and sanctuaries at Naukratis. Herodotus and archaeology, in M.H. Hansen/K. Raaflaub (eds), *More studies in the ancient Greek polis*, Stuttgart, 17-37.
- Bowie, E.L., 1986: Early Greek elegy, symposium and public festival *JHS* 106, 13-35.
- Bowie, E.L., 2001: Ancestors of historiography in early Greek elegiac and iambic poetry?, in N. Luraghi (ed.), *The historian's craft in the age of Herodotus*, Oxford, 45-66.
- Brather, S., 2000: Ethnische Identitäten als Konstrukte der frühgeschichtlichen Archäologie, *Germania* 78, 139-177.
- Brinkman, J.A., 1989: The Akkadian words for "Ionia" and "Ionian", in R.F. Sutton (ed.), *Daidalikon. Studies in memory of R. V. Schoder*, Wauconda, 53-71.
- Brize, P., 1997: Offrandes de l'époque géométrique et archaïque à l'Héraion de Samos, in J. de La Genière (ed.), *Images, espaces, cultes. Actes du colloque international du Centre de Recherches Archéologiques de l'Université de Lille III et de l'Association P.R.A.C., Lille, 1993*, Naples, 123-139.
- Bryce, T., 1998: *The kingdom of the Hittites*, Oxford.
- Burkert, W., 1979: Kynaithos, Polycrates, and the Homeric Hymn to Apollo, in G. W. Bowersock et al. (eds), *Arktouros. Hellenic studies presented to B.M.W. Knox*, Berlin, 53-62.
- Burkert, W., 1984: *Die orientalisierende Epoche in der griechischen Religion und Literatur*, Heidelberg.
- Büyükkolancı, M., 2000: Excavations on Ayasuluk Hill in Selçuk/Turkey. A contribution to the early history of Ephesus, in F. Krinzing (ed.), *Akten des Symposions "Die Ägäis und das westliche Mittelmeer. Beziehungen und Wechselwirkungen 8. bis 5. Jh. v. Chr."*, Wien, 24. bis 27. März 1999, Wien, 39-43.

- Cahill, N., 1988: Taş Kule. A Persian period tomb near Phokaia, *AJA* 92, 485-501.
- Carruba, O., 1995: Ahhiyā and Ahhiyawā, la Grecia e l'Esgeo, in Th.P.J. van den Hout/J. de Roos (eds), *Studio historiae ardens. Ancient Near Eastern studies presented to Ph.H.J. Houwink ten Cate on the occasion of his 65th birthday*, Istanbul, 7-21.
- Cartledge, P., 1993: *The Greeks. A portrait of Self and Others*, Oxford/New York.
- Cassola, F., 1957: *La Ionia nel mondo miceneo*, Napoli.
- Clay, J.S., 1989: *The politics of Olympus. Form and meaning in the major Homeric Hymns*, Princeton.
- Cobet, J., 1997: Milet 1994-1995. Die Mauern sind die Stadt. Zur Stadtbefestigung des antiken Milet, *AA*, 249-284.
- Cobet, J., 2007: Das alte Ionien in der Geschichtsschreibung, in J. Cobet et al. (eds), 729-743.
- Cobet, J., et al. (eds): *Frühes Ionien. Eine Bestandsaufnahme. Panionion-Symposium Güzelçamlı, 1999*, Mainz am Rhein.
- Coldstream, J.N., 1977: *Geometric Greece*, London.
- Coldstream, J.N., 1993: Mixed marriages at the frontiers of the Greek world, *Oxford Journal of Archaeology* 12, 89-107.
- Coleman, J.E., 1997: Ancient Greek ethnocentrism, in J.E. Coleman/A. Walz (eds), *Greeks and barbarians. Essays on the interactions between Greeks and non-Greeks in antiquity and the consequences for Eurocentrism*, Bethesda MA, 175-220.
- Connor, W.R., 1993: The Ionia era of Athenian civic identity, *Proceedings of the American Philological Society* 137, 194-206.
- Cook, J.M., 1958-1959: Old Smyrna, 1948-1951, *BSA* 53-54, 1-34.
- Cook, J.M., 1960: Greek archaeology in western Asia Minor, *AR* 6, 27-57.
- Cook, J.M., 1961: Greek settlement in the eastern Aegean and Asia Minor, *CAH II* (rev. ed.), Cambridge etc., 3-33.
- Cook, J.M., 1982a: East Greece, *CAH III-1* (2nd ed.), Cambridge etc., 745-753.
- Cook, J.M., 1982b: The eastern Greeks, *CAH III-3* (2nd ed.), Cambridge etc., 196-221.
- Cook, J.M., 1985: On the date of Alyattes' sack of Smyrna, *BSA* 80, 25-28.
- Cook, J.M./D.J. Blackman, 1971: Archaeology in western Asia Minor 1965-70, *AR* 17, 33-62.
- Cook, J.M./R.V. Nicholls, 1998: *Old Smyrna excavations. The temples of Athena (British School of Archaeology at Athens - Supplementary volume 30)*, London.
- Corsaro, M., 1991: Gli Ioni tra Greci e Persiani. Il problema dell'identità ionica nell'ambito culturale e politico del V secolo, in H. Sancisi-Weerdenburg/A. Kuhrt (eds), *Achaemenid history VI. Asia Minor and Egypt: old cultures in a new empire. Proceedings of the Groningen 1988 Achaemenid history workshop*, Leiden, 41-55.
- Crielaard, J.P., 1995: Homer, history and archaeology. Some remarks on the date of the Homeric world, in J.P. Crielaard (ed.), *Homeric Questions. Essays in philology, ancient history and archaeology, including the papers of a conference organized by the Netherlands Institute at Athens, 1993*, Amsterdam, 201-288.
- Crielaard, J.P., 1996: *The Euboeans overseas. Long-distance contacts and colonization as status activities in Early Iron Age Greece*, PhD diss., University of Amsterdam.
- Crielaard, J.P., 1998a: Surfing on the Mediterranean web. Cypriot long-distance communications during the 11th and 10th centuries B.C., in V. Karageorghis/N.C. Stampolidis (eds), *Proceedings of the international symposium "Eastern Mediterranean, Cyprus-Dodecanese-Crete, 16th-6th c. B.C."*, Rethymnon, 1997, Athens, 187-206.
- Crielaard, J.P., 1998b: Cult and death in early 7th-century Euboea. The aristocracy and the polis, in S. Marchegay et al. (eds), *Nécropoles et pouvoir. Idéologies, pratiques et interprétations. Actes du colloque Théories de la nécropole antique, Lyon, 1995*, Lyon, etc., 43-58.

- Crielaard, J.P., 2002: Past or present? Epic poetry, aristocratic self-representation and the concept of time in the eighth and seventh centuries BC, in F. Montanari (ed.), *Omero tremila anni dopo (Storia e letteratura 210)*, Roma, 239–295.
- Crielaard, J.P., 2006: *Basileis* at sea. Elites and external contacts in the Euboian Gulf region from the end of the Bronze Age to the beginning of the Iron Age, in S. Deger-Jalkotzy/I.S. Lemos (eds), *Ancient Greece. From the Mycenaean palaces to the age of Homer*, Edinburgh, 271–297.
- Crielaard, J.P., 2009: Cities, in K.A. Raaflaub/H. van Wees (eds), *A Companion to Archaic Greece*, London, 349–372.
- Debord, P., 2001: Les péries des îles voisines de l'Asie Mineure, *Revue des études anciennes* 103, 205–218.
- De Vos, G., 1995: Ethnic pluralism. Conflict and accommodation. The role of ethnicity in social history, in L. Romanucci-Ross/G. De Vos (eds), *Ethnic identity. Creation, conflict and accommodation* (3rd ed.), Walnut Creek etc., 15–47.
- De Vos, G./L. Romanucci-Ross (eds), 1975: *Ethnic identity. Cultural continuities and change*, Palo Alto.
- Dietrich, M./O. Loretz, 1998: Amurru, Yaman und die ägäischen Inseln nach den ugaritischen Texten, in S. Isre'el et al. (eds), *Past links. Studies in the languages and cultures of the ancient Near East (Israel Oriental Studies 18)*, Winona Lake, 335–363.
- Driessen, J., 1998/1999: *Kretes* and *Iawones*. Some observations on the identity of Late Bronze Age Knosians, in J. Bennet/J. Driessen (eds), *A-na-qa-ta. Studies presented to J.T. Killen (Minos 33–34)*, Salamanca, 83–105.
- Dugas, C., 1928: *Les vases de l'Héraion (Délos X)*, Paris.
- Dugas, C., 1935: *Les vases orientalisants du style non mélien (Délos XVII)*, Paris.
- Dugas, C./C. Rhomaios, 1934: *Les vases préhelléniques et géométriques (Délos XV)*, Paris.
- Eastwood, W.J. et al., 1998: Palaeoecological and archaeological evidence for human occupation in south-west Turkey. The Beyşehir occupation phase, *AnatSt* 48, 69–86.
- Ehrhardt, N., 1983: *Milet und seine Kolonien*, Frankfurt.
- Ehrhardt, N., 1985: Bemerkungen zu den Weihgraffiti aus Gravisca, *Zeitschrift für Papyrologie und Epigraphik* 60, 139–143.
- Ehrhardt, N., 2006: Die karische Bevölkerung Milets, in R. Biering et al. (eds), *Maiandros. Festschrift für V. von Graeve*, München, 81–89.
- Elat, M., 1991: Phoenician overland trade within the Mesopotamian empires, in M. Cogan/I. Eph'al (eds), *Ah, Assyria ... Studies in Assyrian history ... presented to H. Tadmor*, Jerusalem, 21–35.
- Emlyn-Jones, C.J., 1980: *The Ionians and Hellenism. A study of cultural achievement of the early Greek inhabitants of Asia Minor*, London.
- Ersoy, Y., 2007: Notes on history and archaeology of early Clazomenae, in J. Cobet et al. (eds), 149–178.
- Fantalkin, A., 2001: Me'ad Hashavyahu. Its material culture and historical background, *Tel Aviv* 28, 3–165.
- Fisher, N.R.E., 1992: *Hybris. A study in the values of honour and shame in ancient Greece*, Warminster.
- Fogazza, G., 1974: Colofone arcaica, *Quaderni urbinati di cultura classica* 18, 23–38.
- Fontenrose, J., 1988: *Didyma. Apollo's oracle, cult and companions*, Berkeley.
- Ford, A., 1992: *Homer. The poetry of the past*, Ithaca/London.
- Geddes, A.G., 1987: Rags and riches. The costume of the Athenian men in the fifth century, *Classical Quarterly* 37, 307–331.
- Gehrke, H.-J., 1994: Mythos, Geschichte, Politik – antik und modern, *Saeculum. Jahrbuch für Universalgeschichte* 45, 239–264.
- Gehrke, H.-J., 2000: Ethnos, phyle, polis. Gemäßigt unorthodoxe Vermutungen, in P. Flensted-Jensen et al. (eds), *Polis & politics. Studies in ancient Greek history presented to M.H. Hansen on his sixtieth birthday, August 20, 2000*, Copenhagen, 159–176.
- Georges, P.B., 1994: *Barbarian Asia and the Greek experience*, Baltimore/London.

- Georges, P.B., 2000: Persian Ionia under Darius. The revolt reconsidered, *Historia* 49, 1-39.
- Gorman, W.B., 2001: *Miletos. The ornament of Ionia. A history of the city to 400 B.C.E.*, Ann Arbor.
- Graf, F., 1985: *Nordionische Kulte. Religionsgeschichtliche und epigraphische Untersuchungen zu den Kulturen von Chios, Erythrai, Klazomenai und Phokaia*, Rome.
- Gras, M., 2000: Commercio e scambi tra oriente e occidente, *Magna Grecia e oriente mediterraneo prima dell'età ellenistica. Atti del 39o convegno di studi sulla Magna Grecia, Taranto, 1-5 ott. 1999*, Taranto, 125-164.
- Greaves, A.M., 2002: *Miletos. A History*, London/New York.
- Greaves, A.M./B. Helwing, 2001: Archaeology in Turkey. The Stone, Bronze, and Iron Ages, 1997-1999, *AJA* 105, 463-511.
- Guralnick, E., 1997: The Egyptian-Greek connection in the 8th to 6th centuries B.C. An overview, in J.E. Coleman/A. Walz (eds), *Greeks and barbarians. Essays on the interactions between Greeks and non-Greeks in Antiquity and the consequences for Eurocentrism*, Bethesda MA, 127-154.
- Gusmani, R., 1975: Kleinasiatische Graffiti aus 'Alt-Smyrna', *Kadmos* 14, 149-153.
- Gusmani, R., 1982: Zwei Graffiti aus Sardis und Umgebung, *Kadmos* 21, 125-129.
- Hägg, R., 1998: Osteology and Greek sacrificial practice, in R. Hägg (ed.), *Ancient Greek cult practice from the archaeological evidence. Proceedings of the fourth international seminar on ancient Greek cult, organized by the Swedish Institute at Athens, 22-24 October 1993*, Stockholm, 49-56.
- Haider, P.W., 1996: Griechen im Vorderen Orient und in Ägypten bis ca. 590 v.Chr., in C. Ulf (ed.), *Wege zur Genese griechischer Identität. Die Bedeutung der früharchaischen Zeit*, Berlin, 59-115.
- Haider, P.W., 2001: Epigraphische Quellen zur Integration von Griechen in die ägyptische Gesellschaft der Saitenzeit, in U. Höckmann/D. Kreikenbom (eds), *Naukratis. Die Beziehungen zu Ostgriechenland, Ägypten und Zypern in archaischer Zeit. Akten der Table Ronde in Mainz, 1999*, Möhnesee, 197-215.
- Hall, E., 1989: *Inventing the barbarian*, Oxford.
- Hall, J., 1997: *Ethnic identity in Greek antiquity*, Cambridge.
- Hall, J., 2000: The east within the cultural identity of the cities of Magna Grecia, *Magna Grecia e oriente mediterraneo prima dell'età ellenistica. Atti del 39o convegno di studi sulla Magna Grecia, Taranto, 1-5 ott. 1999*, Taranto, 389-401.
- Hall, J., 2002: *Hellenicity. Between ethnicity and culture*, Chicago.
- Hall, J., 2007: Polis, community, and ethnic identity, in H.A. Shapiro (ed.), *The Cambridge companion to Archaic Greece*, Cambridge, 40-60.
- Hanfmann, G.M.A., 1948: Archaeology in Homeric Asia Minor, *AJA* 52, 135-155.
- Hanfmann, G.M.A., 1962: A "Hittite" priest from Ephesos, *AJA* 66, 1-4.
- Hanfmann, G.M.A., 1981/1983: Sardis, Old Smyrna pyrgoi. New light on an old problem, in C. Bayburtluoğlu (ed.), *Akurgal'a Armağan/Festschrift Akurgal (Anadolu/Anatolia 22)*, 239-253.
- Hanfmann, G.M.A. (ed.), 1983a: *Sardis from prehistoric to Roman times*, Cambridge MA/London.
- Hanfmann, G.M.A., 1983b: On the gods of Lydian Sardis, in R.M. Boehmer/H. Hauptmann (eds), *Beiträge zur Altertumskunde Kleinasien. Festschrift für K. Bittel*, Mainz am Rhein, 219-231.
- Hawkins, J.D., 1998: Tarkasnawa King of Mira. 'Tarkondemos', Boğasköy sealings and Karabel, *AnatSt* 48, 1-31.
- Heinrichs, J., 1989: *Ionien nach Salamis. Die kleinasiatischen Griechen in der Politik und politischen Reflexion des Mutterlandes*, Bonn.
- Heinzel, E., 1999: Neleus, Herscher von Pylos, und der Gründermythos von Milet, *ÖJh* 68, 1-11.
- Held, W., 2000: *Das Heiligtum der Athena in Milet*, Mainz am Rhein (Milesische Forschungen 2).
- Helm, P.R., 1980: 'Greeks' in the Neo-Assyrian Levant and 'Assyria' in early Greek writers, PhD diss., University of Pennsylvania.
- Herda, A., 2006: Panionion-Melia, Mykalessos-Mykale, Perseus und Medusa. Überlegungen zur Besiedlungsgeschichte der Mykale in der frühen Eisenzeit, *IstMitt* 56, 43-102.

- Herman, G., 1987: *Ritualised friendship and the Greek city*, Cambridge.
- Hobsbawm, E., 1983: Introduction. Inventing traditions, in E. Hobsbawm/T. Ranger (eds), *The invention of tradition*, Cambridge etc., 1-14.
- Höckmann, U., 1996: Die Sitzstatue des "Propheten" aus Didyma, *IstMitt* 46, 93-102.
- Hölbl, G., 1999: Funde aus Milet VIII. Die Aegyptiaca vom Aphroditetempel auf dem Zeytintepe, *AA*, 345-371.
- Hogarth, D.G., 1908: *British Museum. Excavations at Ephesus. The Archaic Artemisia*, London.
- Horrocks, G., 1997: Homer's dialect, in I. Morris/B.B. Powell (eds), *A new companion to Homer*, Leiden, 193-217.
- Huxley, G.L., 1966: *The early Ionians*, London.
- Janko, R., 1982: *Homer, Hesiod and the Hymns*, Cambridge.
- Jarosch, V., 1994: *Samische Tonfiguren des 10. bis 7. Jahrhunderts v. Chr. aus dem Heraion von Samos (Samos XVIII)*, Bonn.
- Jeffery, L.H., 1964: Old Smyrna. Inscriptions on sherds and small objects, *BSA* 59, 39-49.
- Jeffery, L.H., 1976: *Archaic Greece. The city states c. 700-500 B.C.*, London.
- Jeffery, L.H., 1990: *The local scripts of Archaic Greece* (rev. ed., with a supplement by A.W. Johnston), Oxford.
- Jones, N.F., 1987: *Public organization in ancient Greece. A documentary study*, Philadelphia.
- Jones, S., 1997: *The archaeology of ethnicity. Constructing identities in the past and present*, London.
- Kaltsas, N., 1996-1997: Κλαζομενιакές Σαρκοφάγοι από το νεκροταφείο της Ακάνθου, *Αρχαιολογικόν Δελτίον* 51-52, 35-50.
- Karageorghis, V. (ed.), 2002: *Limestone statuettes of Cypriote type found in the Aegean – provenance studies*, Nicosia.
- Kasper, S., 1976-1977: Der Tumulus von Belevi (Grabungsbericht), *ÖJh – Beiblatt* 51, 127-180.
- Kearns, J.M., 1992: *The languages of Lydian Ionia*, Los Angeles.
- Kerschner, M., 2006: Die Ionische Wanderung im Lichte neuer archäologischer Forschungen in Ephesos, in E. Olshausen/H. Sonnabend (eds), *"Troianer sind wir gewesen" – Migrationen in der antiken Welt (Stuttgarter Kolloquium zur Historischen Geographie des Altertums 8, 2002)*, Stuttgart, 364-382.
- Kilian-Dirlmeier, I., 1985: Fremde Weihungen in griechischen Heiligtümern vom 8. bis zum Beginn des 7. Jahrhunderts v. Chr., *Jahrbuch des Römisch-Germanischen Zentralmuseums* 32, 215-254.
- Kirk, G.S., 1985: *The Iliad. A commentary*, I. Books 1-4, Cambridge.
- Kleiner, G. et al., 1967: *Panionion und Melie*, Berlin (Jahrbuch des Deutschen Archäologischen Instituts -Ergänzungsheft 23).
- Kopaniak, K., 2001: Der ägyptisierende "Branchide" aus Didyma, in H. Klinkott (ed.), *Anatolien im Lichte kultureller Wechselwirkungen. Akkulturationsphänomene in Kleinasien und seinen Nachbarregionen während des 2. und 1. Jahrtausends v. Chr.*, Tübingen, 149-166.
- Kraft, J.C. et al., 2000: A geologic analysis of ancient landscapes and the harbours of Ephesos and the Artemision in Anatolia, *ÖJh* 69, 175-233.
- Kuhrt, A., 2002: Greek contact with the Levant and Mesopotamia in the first half of the first millennium BC. A view from the east, in G.R. Tsetskhladze/A.M. Snodgrass (eds), *Greek settlements in the eastern Mediterranean and the Black Sea*, Oxford, 17-25.
- Kullmann, W., 1999: Homer und Kleinasien, in J.N. Kazazis/A. Rengakos (eds), *Ευφοροσύνη. Studies in ancient epic and its legacy in honour of D.N. Maronitis*, Stuttgart, 189-201.
- Kurke, L., 1992: The politics of 'αβροσύνη in Archaic Greece, *Classical Antiquity* 11, 91-120.
- Kurke, L., 1999: *Coins, bodies, games, and gold. The politics of meaning in Archaic Greece*, Princeton.
- Kyrieleis, H., 1996: *Der grosse Kuros von Samos (Samos X)*, Bonn.
- de La Genière, J., 1984: "Parfumés comme Crésus". De l'origine du lécythe attique, *Bulletin de correspondance hellénique* 108, 91-98.

- Lambrinoudakis, V./O. Philaniotou-Hadjianastasiou 2001: The town of Naxos at the end of the Late Bronze Age. The Mycenaean fortification wall, in V. Karageorghis/Chr.E. Morris (eds), *Defensive settlements of the Aegean and the eastern Mediterranean after c. 1200 B.C.*, Nicosia, 157-169.
- Lanfranchi, G.B., 2000: The ideological and political impact of the Assyrian imperial expansion on the Greek world in the 8th and 7th centuries BC, in S. Aro/R.M. Whiting (eds), *The heirs of Assyria. Proceedings of the opening symposium of the Assyrian and Babylonian Intellectual Heritage Project, Tvärminne, Finland, 1998*, Helsinki, 7-34.
- Latacz, J., 2004: *Troy and Homer. Towards a solution of an old mystery*, Oxford.
- Lazzarini, M.L., 1978: Neleo a Samo, *Rivista di filologia e di istruzione classica* 106, 179-191.
- Lembesi, A., 1999: Σχέσεις Σάμου και Κρήτης τον 7^ο αι., in N.Chr. Stampolidis (ed.), *Φως Κυκλαδικών. Γεωμετρικός τόμος στη μνήμη του Ν. Ζαφειροπούλου*, Αθήνα, 148-157.
- Lemos, A., 2000: Aspects of East Greek pottery and vase painting, in F. Krinzing (ed.), *Akten des Symposiums "Die Ägäis und das westliche Mittelmeer. Beziehungen und Wechselwirkungen 8. bis 5. Jh. v. Chr."*, Wien, 24. bis 27. März 1999, Wien, 377-391.
- Lemos, I.S. 2002: *The Protogeometric Aegean. The Archaeology of the Late Eleventh and Tenth Centuries BC*, Oxford.
- Lemos, I.S. 2007: The migrations to the west coast of Asia Minor. Tradition and archaeology, in J. Cobet *et al.* (eds), 712-727.
- Liverani, M., 1991: The trade network of Tyre according to Ezek. 27, in M. Cogan/I. Eph'al (eds), *Ah, Assyria ... Studies in Assyrian history ... presented to H. Tadmor*, Jerusalem, 65-79.
- Lohmann, H., 1995: Survey in der Chora von Milet. Vorbericht über die Kampagnen der Jahre 1990, 1992 und 1993, *AA*, 293-333.
- Lohmann, H., 1997: Survey in der Chora von Milet. Vorbericht über die Kampagnen der Jahre 1994 und 1995, *AA*, 285-311.
- Lohmann, H., 1999: Survey in der Chora von Milet. Vorbericht über die Kampagnen der Jahre 1996 und 1997, *AA*, 439-473.
- Lohmann, H., 2004: Mélia, le Panionion et le culte de Peséidon Héliconios, in G. Labarre *et al.* (eds), *Les cultes locaux dans les mondes grec et romain. Actes du colloque de Lyon, 2001*, Lyon/Paris, 31-49.
- Lohmann, H., 2007: Die Chora Milets in Archaischer Zeit, in J. Cobet *et al.* (eds), 361-392.
- Lohmann, H. *et al.*, 2007: Forschungen und Ausgrabungen in der Mykale 2001-2006, *IstMitt* 57, 59-178.
- Lombardo, M./F. Frisone, 2000: Profughi e coloni dell'Asia Minore in Magna Grecia (VII-V sec. a.C.), in *Magna Grecia e oriente mediterraneo prima dell'età ellenistica. Atti del 39° convegno di studi sulla Magna Grecia, Taranto, 1-5 ott. 1999*, Taranto, 189-277.
- Luraghi, N., 2006: Traders, pirates, warriors. The proto-history of Greek mercenary soldiers in the eastern Mediterranean, *Phoenix* 60, 21-47.
- Luraghi, S., 1998: The Anatolian languages, in G.A. Ramat/P. Ramat (eds), *The Indo-European languages*, London, 169-196.
- McInerney, J., 2001: Ethnos and ethnicity in early Greece, in I. Malkin (ed.), 51-73.
- Malkin, I., 1998: *The returns of Odysseus. Colonization and ethnicity*, Berkeley etc.
- Malkin, I. (ed.), 2001: *Ancient perceptions of Greek ethnicity*, Cambridge MA/London.
- Mallwitz, A., 1981: Kritisches zur Architektur Griechenlands im 8. und 7. Jahrhundert, *AA*, 599-642.
- Masson, O., 1962: *Les fragments du poète Hipponax*, Paris.
- Masson, O./J. Yoyotte, 1988: Une inscription ionienne mentionnant Psammétique 1er, *Epigraphica Anatolica* 11, 171-180.
- Mazarakis Ainian, A., 1997: *From ruler's dwellings to temples. Architecture, religion and society in Early Iron Age Greece (1100-700 B.C.)*, Jonsered.
- Mazzarino, S., 1947: *Fra Oriente ed Occidente*, Firenze.

- Meiggs, R./D. Lewis (eds), 1969: *A selection of Greek historical inscriptions to the end of the fifth century B.C.*, Oxford.
- Mellink, M.J., 1981/1983: East Greek or Hittite?, in C. Bayburtluoğlu (ed.), *Akurgal'a Armağan/Festschrift Akurgal (Anadolu/Anatolia 22)*, 47-55.
- Mellink, M.J., 1983: Comments on a cult relief of Kybele from Gordion, in R.M. Boehmer/H. Hauptmann (eds), *Beiträge zur Altertumskunde Kleinasiens. Festschrift für K. Bittel*, Mainz am Rhein, 349-360.
- Mercangöz, Z., 2002: Kuşadası, Kadı Kalesi Kazısı, *İzmir Kent Kültürü Dergisi* 5 (Feb.), 272-276.
- Meriç, R., 2002: Metropolis Yakınındaki "Hitit" Çağdaş Bir Arzawa Kenti. Puranda, *İzmir Kent Kültürü Dergisi* 5 (Feb.), 230-234.
- Milojčić, V., 1961: *Die prähistorische Siedlung unter dem Heraion – Grabung 1953 und 1955*, Bonn (Samos I).
- Mitchell, L., 2007: *Panhellenism and the barbarian in Archaic and Classical Greece*, Swansea.
- Mitchell, S., 1990: Archaeology in Asia Minor 1985-89, *AR* 36, 83-131.
- Mitchell, S., 1999: Archaeology in Asia Minor 1990-98, *AR* 45, 125-191.
- Möller, A., 2000: *Naukratis. Trade in Archaic Greece*, Oxford.
- Morgan, C., 1993: The origins of pan-Hellenism, in N. Marinatos/R. Hägg (eds), *Greek sanctuaries. New approaches*, London/New York, 18-44.
- Morgan, C./J. Hall, 1996: Achaian *poleis* and Achaian colonisation, in M.H. Hansen (ed.), *Introduction to an inventory of poleis. Acts of the Copenhagen Polis Centre 3*, Copenhagen, 164-232.
- Morpurgo Davies, A., 2002: The Greek notion of dialect, in Th. Harrison (ed.), *Greeks and barbarians*, Edinburgh, 153-171.
- Morris, I., 2000, *Archaeology as cultural history. Words and things in Iron Age Greece*, Oxford.
- Morris, S.P., 2001: The prehistoric background of Artemis Ephesia. A solution to the enigma of her 'breasts', in U. Muss (ed.), *Der Kosmos der Artemis von Ephesos*, Wien, 135-151.
- Mountjoy, P.A., 1998, The east Aegean-west Anatolian interface in the Late Bronze Age. Mycenaean and the kingdom of Ahhiyawa, *AnatSt* 48, 33-67.
- Mountjoy, P.A., 1999: *Regional Mycenaean decorated pottery II*, Rahden.
- Mountjoy, P.A., 2005: Mycenaean connections with the Near East in LH IIIC. Ships and Sea Peoples, in R. Laffineur/E. Greco (eds), *Emporia. Aegeans in the central and eastern Mediterranean. Proceedings of the 10th international Aegean conference, Athens, Italian School of Archaeology, 2004*, Liège/Austin (Aegaeum 25), 423-427.
- Murray, O., 1988: The Ionian Revolt, *CAH IV* (2nd ed.), Cambridge etc., 461-490.
- Murray, O., 1990: Cities of reason, in O. Murray/S. Price (eds), *The Greek city from Homer to Alexander*, Oxford, 1-16.
- Muss, U., 2001: Vom Mythos zur Archäologie eines Heiligtums. Ein bronzzeitlicher Kopf aus dem Artemision, in U. Muss (ed.), *Der Kosmos der Artemis von Ephesos*, Wien, 153-168.
- Naumann, F., 1983: *Die Ikonographie der Kybele in der phrygischen und der griechischen Kunst*, Tübingen.
- Niemeier, W.-D., 1998: The Mycenaean in western Anatolia and the problem of the origins of the Sea Peoples, in S. Gitin et al. (eds), *Mediterranean peoples in transition. Thirteenth to early tenth centuries BCE. In honour of professor T. Dothan*, Jerusalem, 17-65.
- Niemeier, W.-D., 1999a: Mycenaean and Hittites in war in western Asia Minor, in R. Laffineur (ed.), *Polemos. Le contexte guerrier en Égée à l'Âge du Bronze. Actes de la 7e rencontre égéenne internationale, Liège, 1998* Liège/Austin (Aegaeum 19), 141-156.
- Niemeier, W.-D., 1999b: 'Die Zierde Ioniens'. Ein archaischer Brunnen, der jüngere Athenatempel und Milet vor der Perserzerstörung, *AA*, 373-413.
- Niemeier, W.-D., 2001: Archaic Greeks in the Orient. Textual and archaeological evidence, *Bulletin of the American Schools of Oriental Research* 322, 11-32.

- Niemeier, W.-D., 2007: Westkleinasien und Ägäis von den Anfängen bis zur Ionischen Wanderung. Topographie, Geschichte und Beziehungen nach dem archäologischen Befund und den hethitischen Quellen, in J. Cobet *et al.* (eds), 37–96.
- Niemeier, B./W.-D. Niemeier, 1997: Milet 1994–1995. Projekt »Minoisch-mykenisches bis protogeometrisches Milet«: Zielsetzung und Grabungen auf dem Stadionhügel und am Athenatempel, *AA*, 189–248.
- Niles, J.D., 1979: On the design of the *Hymn to Delian Apollo*, *Classical Journal* 75, 36–39.
- Ohly, D., 1953: Holz, *Mitteilungen des Deutschen Archäologischen Instituts – Athenische Abteilung* 68, 77–126.
- Onyshkevych, L., 2002: Interpreting the Berezan bone graffito, in V.B. Gorman/E.W. Robinson (eds), Oikistes. *Studies in constitutions, colonies, and military power in the ancient world. Offered in honour of A.J. Graham (Mnemosyne Suppl. 234)*, Leiden etc., 161–179.
- Özgen, I./J.Öztürk, 1996: *Heritage recovered. The Lydian treasure*, Ankara.
- Parke, H.W., 1985: *The oracles of Apollo in Asia Minor*, London.
- Parke, H.W., 1988: *Sibyls and Sibylline prophecy in classical Antiquity*, London.
- Patzek, B., 1992: *Homer und Mykene. Mündliche Dichtung und Geschichtschreibung*, München.
- Pernigotti, S., 1999: *I greci nell'Egitto della XXVI Dinastia*, Imola.
- Piérart, M., 1978: La “sixième tribu” de Milet, *Bulletin de correspondance hellénique* 102, 563–564.
- Piérart, M., 1985: Modèles de répartition des citoyens dans les cités ioniennes, *Revue des études anciennes* 87, 169–190.
- Pipili, M., 2000: Vases from the Samian Heraion. Shapes and iconography, *ἄγαθός δαίμων. Mythes et cultes. Études d'iconographie en l'honneur de Lilly Kahil*, Paris (Bulletin de correspondance hellénique – Supplément 38), 409–421.
- Polignac, F. de, 1994: Mediation, competition, and sovereignty. The evolution of rural sanctuaries in Geometric Greece, in S.E. Alcock/R. Osborne (eds), *Placing the gods. Sanctuaries and sacred space in ancient Greece*, Oxford, 3–18.
- Polignac, F. de, 1995: *Cults, territory, and the origins of the Greek city-state*, Chicago/London.
- Polignac, F. de, 1996: Offrandes, mémoire et compétition ritualisée dans les sanctuaires grecs à l'époque géométrique, in P. Hellström/B. Alroth (eds), *Religion and power in the ancient Greek world. Proceedings of the Uppsala symposium 1993*, Uppsala, 59–66.
- Prinz, F., 1979: *Gründungsmythen und Sagenchronologie*, Göttingen.
- Prinz, H., 1908: *Funde aus Naukratis*, Leipzig.
- Ragone, G., 1986: La guerra meliaca e la struttura originaria della lega ionica in Vetruvio 4, 1, 3–6, *Rivista di filologia e di istruzione classica* 114, 173–205.
- Ratté, C., 1992: The Pyramid tomb near Sardes, *IstMitt* 42, 135–161.
- Ray, J.D., 1990: An outline of Carian grammar, *Kadmos* 29, 54–83.
- Renfrew, C., 1998: Words of Minos. The Minoan contribution to Mycenaean Greek and the linguistic geography of the Bronze Age Aegean, *Cambridge Archaeological Journal* 8, 239–264.
- Roebuck, C., 1953: The economic development of Ionia, *Classical Philology* 48, 9–16.
- Roebuck, C., 1955: The early Ionian league, *Classical Philology* 50, 26–40.
- Roebuck, C. 1959: *Ionian trade and colonization*, New York.
- Roebuck, C., 1961: Tribal organization in Ionia, *Transactions of the American Philological Association* 92, 495–507.
- Roller, L.E., 1999: *In search of god the mother. The cult of Anatolian Cybele*, Berkeley.
- Röllig, W., 1992: Asia Minor as a bridge between east and west. The role of the Phoenicians and Aramaeans in the transfer of culture, in G. Kopcke/I. Tokumaru (eds), *Greece between east and west, 10th–8th centuries BC. Papers of the meeting at the Institute of Fine Arts, New York University, 1990*, Mainz am Rhein, 93–102.

- Rollinger, R., 2001: The ancient Greeks and the impact of the ancient Near East. Textual evidence and historical perspective (ca. 750–650 BC), in R.M. Whiting (ed.), *Mythology and mythologies. Methodological approaches to intercultural influences. Proceedings of the second annual symposium of the Assyrian and Babylonian Heritage Project, Paris, 1999*, Helsinki, 233–264.
- Ross, S.A., *Barbarophonos*. Language and Panhellenism in the *Iliad*, *Classical Philology* 100, 299–316.
- Russo, J. et al., 1992: *A commentary on Homer's Odyssey*, III. Books XVII–XXIV, Oxford.
- Roussel, D., 1976: *Tribu et cité. Études sur les groupes sociaux dans les cités grecques aux époques archaïque et classique*, Paris.
- Sakellariou, M.B., 1958: *La migration grecque en Ionie*, Athènes.
- Sakellariou, M.B., 1989: *The polis-state. Definition and origin*, Athens.
- Schaps, D.M., 2004: *The invention of coinage and the monetization of ancient Greece*, Ann Arbor.
- Schattner, T.G., 1996: Architrav und Fries des archaischen Apollontempels von Didyma, *Jahrbuch des Deutschen Archäologischen Instituts* 111, 1–23.
- Schmidt, G., 1968: *Kyprische Bildwerke aus dem Heraion von Samos (Samos VII)*, Bonn.
- Schneider, P., 1996: Zum alten Sekos in Didyma, *IstMitt* 46, 147–152.
- Shennan, S. (ed.), 1989: *Archaeological approaches to cultural identity*, London.
- Sherratt, E.S., 1990: 'Reading the texts'. Archaeology and the Homeric question, *Antiquity* 64, 807–824.
- Shipley, D.G.J., 1987: *A history of Samos 800–188 BC*, Oxford.
- Simon, C.G., 1997: The archaeology of cult in Geometric Greece. Ionian temples, altars, and dedications, in S. Langdon (ed.), *New light on a dark age. Exploring the culture of Geometric Greece*, Columbia/London, 125–143.
- Smith P. M., 1981: Aineiadaï as patrons of *Iliad* XX and the Homeric *Hymn to Aphrodite*, *Harvard Studies in Classical Philology* 85, 17–58.
- Snodgrass, A.M., 1964: Carian armourers – the growth of a tradition, *JHS* 84, 107–118.
- Snodgrass, A.M., 1971: *The Dark Age of Greece. An archaeological survey of the eleventh to the eighth centuries BC*, Edinburgh.
- Snodgrass, A.M., 1980: *Archaic Greece. The age of experiment*, London.
- Snodgrass, A.M., 1986: Interaction by design. The Greek city state, in C. Renfrew/J.F. Cherry (eds), *Peer polity interaction and the development of sociocultural complexity*, Cambridge, 47–58.
- Sourvinou-Inwood, C., 1990: What is *polis* religion?, in O. Murray/S. Price (eds), *The Greek city from Homer to Alexander*, Oxford, 295–322.
- Soykal, F., 2002: Rock-cut sacred areas at Ephesos in the light of new surveys (summary), *AJA* 106, 274–275.
- Starke, E., 1997: Troia im Kontext des historisch-politischen und sprachlichen Umfeldes Kleinasiens im 2. Jahrtausend, *Studia Troica* 7, 447–487.
- Sullivan, R.D., 1996: Psammetichus I and the foundation of Naukratis, in W.D.E. Coulson (ed.), *Ancient Naukratis II-1. The survey at Naukratis and environs*, Oxford, 177–195.
- Talamo, C., 1973: Per la storia di Colofone in età arcaica, *La parola del passato* 28, 343–376.
- Tausend, K., 1992: *Amphiktyonie und Symmachie. Formen zwischenstaatlicher Beziehungen im archaischen Griechenland*, Stuttgart (Historia Einzelschriften 73).
- Thomas, R., 2001: Ethnicity, genealogy, and Hellenism in Herodotus, in I. Malkin (ed.), 213–233.
- Thomas, R. 2004: Herodotus, Ionia and the Athenian empire, in V. Karageorghis/I. Taifacos (eds), *The world of Herodotus. Proceedings of an international conference held at Nicosia, 2003*, Nicosia, 27–42.
- Tölle-Kastenbein, R., 1994: Zur Genesis und Entwicklung des Peripteros, *Jahrbuch des Deutschen Archäologischen Instituts* 109, 41–76.
- Torelli, M., 1977: Il santuario greco di Gravisca, *La parola del passato* 32, 398–458.
- Torelli, M., 1982: Per la definizione del commercio greco-orientale. Il caso di Gravisca, *La parola del passato* 37, 304–325.

- Tsetskhladze, G.R., 2002: Ionians abroad, in G.R. Tsetskhladze/A.M. Snodgrass (eds), *Greek settlements in the eastern Mediterranean and the Black Sea*, Oxford, 81-96.
- Tuchelt, K., 1970: *Die archaischen Skulpturen von Didyma. Beiträge zur frü griechischen Plastik in Kleinasien*, Berlin (Istanbuler Forschungen 27).
- Tuchelt, K., 1988: Die Perserzerstörung von Branchidai-Didyma und ihre Folgen – archäologisch betrachtet, *AA*, 427-438.
- Tuchelt, K., 1991a: *Branchidai-Didyma. Geschichte, Ausgrabung und Wiederentdeckung eines antiken Heiligtums 1765 bis 1990*, Mainz am Rhein (Antike Welt Sondernummer 22).
- Tuchelt, K., 1991b: Drei Heiligtümer von Didyma und ihre Grundzüge, *Revue archéologique*, 85-98.
- Tuchelt, K., 1992: Tieropfer in Didyma – ein Nachtrag, *AA*, 61-81.
- Tuchelt, K. et al., 1996: *Ein Kultbezirk an der Heiligen Straße von Milet nach Didyma*, Mainz am Rhein.
- Tuna, N., 1997: Teos Araştırmaları 1995, *XIV. Araştırma Sonuçları Toplantısı, Ankara, Mayıs 1996*, 219-233.
- Ulf, C., 1996b: Griechische Ethnogenese versus Wanderungen von Stämmen und Stammstaaten, in C. Ulf (ed.), *Wege zur Genese griechischer Identität. Die Bedeutung der früharchaischen Zeit*, Berlin, 240-280.
- Van Wees, H., 2002: Homer and early Greece, *Colby Quarterly* 38, 94-117.
- Van Wees, H., 2005: Trailing tunics and sheepskin coats. Dress and status in early Greece, in L. Cleland et al. (eds), *The clothed body in the ancient world*, Oxford, 44-51.
- Villing, A., 1998: Athena as Ergane and Promachos. The iconography of Athena in Archaic East Greece, in N. Fisher/H. van Wees (eds), *Archaic Greece. New approaches and new evidence*, London, 147-168.
- Vittmann, G., 2003: *Ägypten und die Fremden im ersten vorchristlichen Jahrtausend*, Mainz am Rhein.
- Wachter, R., 2001: *Non-Attic Greek vase inscriptions*, Oxford.
- Wade-Gery, H.T. 1952: *The Poet of the Iliad*, Cambridge.
- Walter, H., 1968: *Frühe Samische Gefäße. Chronologie und Landschaftsstile ostgriechischer Gefäße (Samos V)*, Bonn.
- Weiß, P., 2006: Was Milet auch bietet. Zu Gewichten, Schleuderbleien und einem lydischen Sprachzeugnis, in R. Biering et al. (eds), *Maiandros. Festschrift für V. von Graeve*, München, 279-284.
- West, M.L., 1975: Cynaethus' hymn to Apollo, *Classical Quarterly* 25, 161-170.
- West, M.L., 1985: *The Hesiodic Catalogue of Women. Its nature, structure, and origins*, Oxford.
- West, M.L., 1988: The rise of Greek epic, *JHS* 108, 151-172.
- West, M.L., 1992: The descent of Greek epic. A reply, *JHS* 112, 173-175.
- West, M.L., 1993: *Greek lyric poetry*, Oxford.
- Whitehead, N., 1992: Tribes make states and states make tribes. Warfare and the creation of colonial tribes and states in northeastern South America, in R. B. Ferguson/N.L. Whitehead (eds), *War in the tribal zone. Expanding states and indigenous warfare*, Sante Fe, 127-150.
- Yardeni, A., 1993: Maritime trade and royal accountancy in an erased customs account from 475 B.C.E. on the Ahiqar scroll from Elephantine, *Bulletin of the American Schools of Oriental Research* 293, 67-78.
- Yntema, D.G., 2000: Mental landscapes of colonization. The ancient written sources and the archaeology of early colonial-Greek southeastern Italy, *Bulletin Antieke Beschaving* 75, 1-49.
- Zaphiropoulou Ph., 2003: *La céramique <<mélienne>> (Délos XLI)*, Paris.

From Athenian identity to European ethnicity – the cultural biography of the myth of Marathon

Hans-Joachim Gehrke

- 1 Introduction
- 2 Persian wars and Greek identity
- 3 Formation: Marathon in Athenian remembrance, private and public
- 4 Debate: The reinterpretation of remembrance
- 5 Reconciliation: The unification and generalisation of remembrance
- 6 Reception: Athenian remembrance as an ideological concept in antiquity
- 7 Beyond antiquity: The myth of Marathon as a modern figure of remembrance
- 8 Conclusion

Abbreviations

References

I INTRODUCTION

You may wonder why, in the context of a book on ‘Ethnic constructs in Antiquity’, I am going to discuss the ethnicity of Europe and to introduce Europe, quite a modern multinational union of different states with different traditions, into the field of research on ethnicity.¹ I believe there are good reasons for doing so. I have spent almost ten years studying the construction of collective identities, particularly the impact of history or of conceptions of the past on the creation of social and collective identity. As a result I have come to believe that ethnic construction is always linked to and shaped by the history or traditions that a given community or society perceives as constituting its own past. Using the anthropological concepts of Wilhelm Mühlmann, I call this kind of history, which is vital to the identity of a group, ‘intentional history’.²

During processes of ethnogenesis in particular, we find an enormous amount of activity relating to the construction of ‘intentional history’: tales are told, myths are formed, and traditions are invented. And all these legends speak of ancestors of the group’s members and of kinship ties between them, intended as real or at least as metaphorical. Modern research on ethnogenesis has shown that such groups or ethnic communities are not fixed units. They can be greatly expanded, for example by prestige and success, as demonstrated by Reinhard Wenkus in his important book on the tribes of the *Völkervanderungszeit*.³

¹ The manuscript of this article was delivered in spring 2003. For contributions to the topic published in the meantime see the references in another version of this paper: Marathon: A European charter myth, in: *Palamedes* 2, 2007, 93-108. In addition, one has to consult now also

M. Meyer, Bilder und Vorbilder. Zu Sinn und Zweck von Siegesmonumenten Athens in klassischer Zeit, *ÖJh* 74, 2005, 277-312.

² Gehrke 1994; idem 2001.

³ Wenkus 1961.



Fig. 1. Topography of the battlefield of Marathon (after Pritchett 1969, 10, fig. 1 and Petrakos 1996, fig. 1).

Nevertheless, to their members, they appear as preformed units held together by bonds of kinship and a common ancestry; people think of their community as physically given. The sociologists Berger and Luckmann would call that phenomenon ‘reification’.⁴

Thus, in analysing ethnic concepts and images of Self and Other, history as ‘intentional history’ comes into play. During the work of the Freiburg interdisciplinary research group (*Sonderforschungsbereich*) on collective identities in Greek and Roman history, we discovered that this special way of dealing with the past did not confine itself to tribes, to *ethne* in the narrower sense, but was equally true of different and much larger types of communities to which we do not normally apply the term ethnicity: for example, the Greek polis, the world of the Hellenes, and the Roman empire.

My aim is to show that the principal elements and the essential structures of ‘intentional history’ are to be found in the construction of European traditions as well and that, by using the past in this way, the growing European community created its identity using time-honoured means and with consequences that are not immediately apparent. I would now like to take you back to a summer in ancient Greece.

On a day in August in the year 490, a Persian armada of several hundred warships and troop transports landed on the long peninsula of Schoinias, on the northern end of the plain of Marathon in eastern Attica (fig. 1-2). Approximately fifteen to twenty thousand Persian, Median and Sacian troops, foot-soldiers together with the fearsome cavalry, disembarked under the command of the Median aristocrat Datis and the Persian prince Arthaphernes. The Great King Darius had sent them to exact revenge for supporting the rebellion of the Greeks of Asia Minor against Persian domination. The army had already destroyed Eretria on Euboea and had deported as many people as they could capture. Among the Persians was Hippias, the tyrant who only 20 years earlier had been driven out by the Athenians and who, after the much anticipated victory, was to be made ruler of Athens and the guarantor of Persian overlordship.

⁴ Berger/Luckmann 1991, esp. 85 ff., 129-30, 177-178.



Fig. 2. Marathon, Schoinia beach looking southwest, with Mt. Agrieliki in the background (author's photo).

The Athenians sent forth their entire contingent of heavy infantry, the hoplites. Some 8,000 strong, they were to block the enemy's path to Athens by engaging them in open battle. These troops were supported by several hundred warriors from the neighbouring city of Plataea. Prominent among their commanders was General (*strategos*) Miltiades. When, several days after their army had landed, the Persians lined up in battle formation, Miltiades drew up the Athenian contingent at the foot of Agrieliki mountain. We are told that, in order to evade the worst of the feared Persian arrows, the hoplites attacked the Persian line in a closed phalanx, marching in double time and covering a distance of more than 1,500 metres. After an arduous battle, they were able to overwhelm their opponent's flank and force the enemy back toward their ships and the sandy marshes. On the following day, the Persians attempted a surprise attack on the city of Athens with their fleet. When they realised that the Athenian army was approaching at a rapid march, they returned home unsuccessfully. All in all, the Athenians had lost 192 men and the Persians several thousand.⁵

Ten years later, the Persians renewed their attack: this time in even grander style and with the aim of subjugating all of Greece. After years of stockpiling arms, the Great King Xerxes had a gigantic force at his command, army and fleet. The Greeks were victorious in one encounter after another (480 and 479) in the strait between the island of Salamis and the Athenian mainland and on the plain of Plataea.⁶ Under the banner of freedom and revenge, they quickly took the offensive against Persian positions in

⁵ The reconstruction is based mainly on Herodotus' account (6. 102 ff.); for further sources and the hitherto definitive modern description of the battle, see Busolt 1895, 578 ff.; for the date, *ibid.* 596-597, n. 4. For a critique of the details of the Athenian attack, see Delbrück

1887, 56 ff.; for the topography of the battlefield, Pritchett 1969, 1 ff.; cf. also recently Doenges 1998, 1-17.

⁶ Cf. esp. the vivid account by Green 1970.

Asia Minor and in the Northern Aegean. In the course of these struggles, the Athenians became the foremost power in the Greek world, thanks to their fleet, which bore the glory of Salamis. And internally, they were able to develop their democratic order free from interruption.

This much, more or less, can be found in any contemporary textbook. But how was the history of the Persian wars constructed? How did Marathon become a myth, so much so that John Stuart Mill later claimed that ‘the battle of Marathon, even as an event in English history, is more important than the Battle of Hastings’?⁷ I would like to address these questions in this paper, and to concentrate on the meaning and interpretation of Marathon in ancient Athens (sections 2–6). In the final part of my argument (section 7), I will take a brief look at developments in modern times as well, thus taking into account how the specific Athenian success evolved into a European charter myth.⁸

2 PERSIAN WARS AND GREEK IDENTITY

The fact that a significant and unexpected victory had been pulled off against the only superpower of the time was of course immediately apparent to all observers. The glory of the warriors was first celebrated in the traditional manner: the heroes were highly praised for the bravery (*arete*) with which they had saved their homeland from slavery. The victors of Marathon, Salamis and Plataea were all treated in similar fashion. However, just a few years later, the victories began to acquire a deeper meaning. This is first apparent in Aeschylus’ *Persians*, performed in the year 472, which charged the events with meaning and which brought into sharp relief the following principles: the Greeks stood against the Barbarians and Freedom was set against Slavery. Indeed, it was then that Greek identity was first linked to the concept of freedom.⁹ Freedom became a constituent part of Greek identity and the Barbarians became associated with oppression. This association reached its height in the following century in Aristotle’s much debated passage which contended that the Barbarians were by nature slaves.¹⁰

The Athenians celebrated in grand style those who fell in battle, with a state burial, an official eulogy, and games held in their honour. It is not clear when these rites were established, i.e. whether they began in the 6th century, sometime after the battle of Marathon, or somewhat later. Nevertheless, we can generally say that it was through these ceremonial games that the fallen acquired the status of heroes.¹¹

3 FORMATION: MARATHON IN ATHENIAN REMEMBRANCE, PRIVATE AND PUBLIC

The beginnings of the remembrance, both private and public, associated specifically with Marathon, can be traced back to the influence of Miltiades’ son Cimon, who was the leading Athenian politician in the years following Salamis until his banishment through ostracism in 461. At the start of the 460s, the Athenians

⁷ Robson 1978, 273.

⁸ For the development of the Marathon remembrance in Athens, see esp. Flashar 1996, 63 ff. A comparable reconstruction has been given by Hölkeskamp 2001. On the myth in antiquity, cf. Nouhaud 1997. The most remarkable works of art are thoroughly discussed by Castriota 1992; cf. also Francis 1990.

⁹ Cf. Raaflaub 1985, 71 ff. Apart from passages in Aeschylus’ *Persai* (241 f., 402 ff.), one of the so-called Marathon Epigrams is significant in that it emphasises liberty and

the most plausible reconstruction of the damaged text links one inscription with the battle of Salamis (*IG I³ 503/4 A 1* with Matthaïou 1988, 118 ff.).

¹⁰ Aristotle, *Politics* 1. 2. 1252 b 5 ff, 3. 14. 1285 a 16 ff., 7. 7. 1327 b 25 ff.

¹¹ On the public funeral, see esp. Stupperich 1977, 31 ff.; Clairmont 1983; on the *agon epitaphios* cf. Diodorus 11.33.3; *IG I³ 523*; on the aspect of heroisation, see Boehringer 1996, 50.

dedicated a large monument in Delphi as a tithe from the spoils of the battle of Marathon. It consisted of a series of bronze statues, wrought by Phidias, representing the ten Attic heroes, and next to them the legendary kings Codrus and Theseus, and Philaius, the ancestor of Miltiades' family. The gods Apollo and Athena were also represented, as was 'Miltiades, one of the generals'.¹² It is worth emphasising that the mythical representatives of the Athenian polis joined together with both the great man Miltiades and his family ancestor, in the presence of the Athenian protecting goddess and of the Lord of the Delphic sanctuary.

Much the same connotation is carried by the images portrayed in a large hall, the Stoa Poecile, a building which Cimon's brother-in-law Peisianax sponsored in about 460 BC and which, with the agreement of the demos, was decorated with several painted masterpieces. The battle of Marathon was depicted here in various scenes. Together with a small number of Athenians, we recognise Miltiades, as well as Athena, Hercules and Theseus, and another demos god (Echetlos). There were three other paintings as well. One showed a battle recently fought against the Spartans, another stood as a reminder of the victory of the Athenians against the attacking Amazons, and the third depicted a famous event at the end of the Trojan war.¹³ We see here not only the emphasis on Miltiades and the association with gods and heroes, as was the case in Delphi. Rather, the iconographic program of the Stoa Poecile displays in parallel – and thereby equates – mythic events (i.e. ancient history) and events of contemporary history.

The texts of three epigrams engraved on three herms (near the later Stoa Poecile) help us to interpret this evidence. The epigrams celebrate a major victory by the Athenians under Cimon's leadership in the Northern Aegean at the end of 476. One epigram is a reminder of the role played by Menestheus, the Athenian leader in the Trojan war. Another praises the recent achievements against the Persians, namely the capture of Eion-on-the Strymon in the Northern Aegean. The third expresses the thanks of the Athenians to their leaders for their good deeds and excellence, and serves to motivate future generations.¹⁴ Cimon himself, the person to be honoured, is not mentioned. Nor is Miltiades named in the inscription of the Stoa Poecile. However, just as we recognise Miltiades, it is clear who is meant here.

We observe here a central characteristic of Athenian democracy: its principles of equality and political participation ran counter to the still strong and highly competitive spirit of the nobility, with its focus on individual and familial honour. This is an attempt to integrate these opposing forces. On the one hand, the nobility uses its bravery – or *arete* – to benefit the polis, which in turn honours the nobility for doing so, although not to an excessive extent. And at the same time, *arete* is collectivised: the nobles stand alongside others and simple soldiers are also given their share of glory. Because of the influence of Miltiades and Cimon, the battle of Marathon provided an ideal example for this *compromesso storico*.

However, we see rather clearly here the extent to which history becomes argument. It is not only the presence of gods and demigods, but also the clear parallelism of the events with mythical models which in turn lends the historical event a mythical character of its own. Historical and mythical events are juxtaposed and equated with one another. Since the Greeks did not make the strict distinction between myth and history that we do today, but rather took the events of myth as their own history,¹⁵ what we understand as a historical event became contextualised, becoming part of a mytho-historical sequence, and what is more, forming its apex.

In this way, together with Salamis, the battle of Marathon became an integral part of the Athenian interpretation of the Persian wars. It symbolised their thirst for freedom, while at the same time serving to legitimise their supremacy in Greece. Herodotus, who was well aware of Athens' new role, focuses precisely on this element in his interpretation of the battle of Marathon, expressed in a speech he attributes to Miltiades.¹⁶

¹² Pausanias 10.1.1. On the votives in general, see Gauer 1968; on the Marathon monument, see Krumeich 1997, 93 ff.; Ioakimidou 1997, 66 ff. On the former votive near the treasury of the Athenians, see Funke 2001, 14 f.

¹³ Pausanias 1.15.3; cf. esp. Hölscher 1973, 50 ff., 186, 239 f.

¹⁴ Aeschines 3.183 ff.; Plutarch, *Kimón* 7.

¹⁵ Gehrke 1994; idem 2001; cf. Flashar 1996, 68.

¹⁶ Herodotus 7.109.

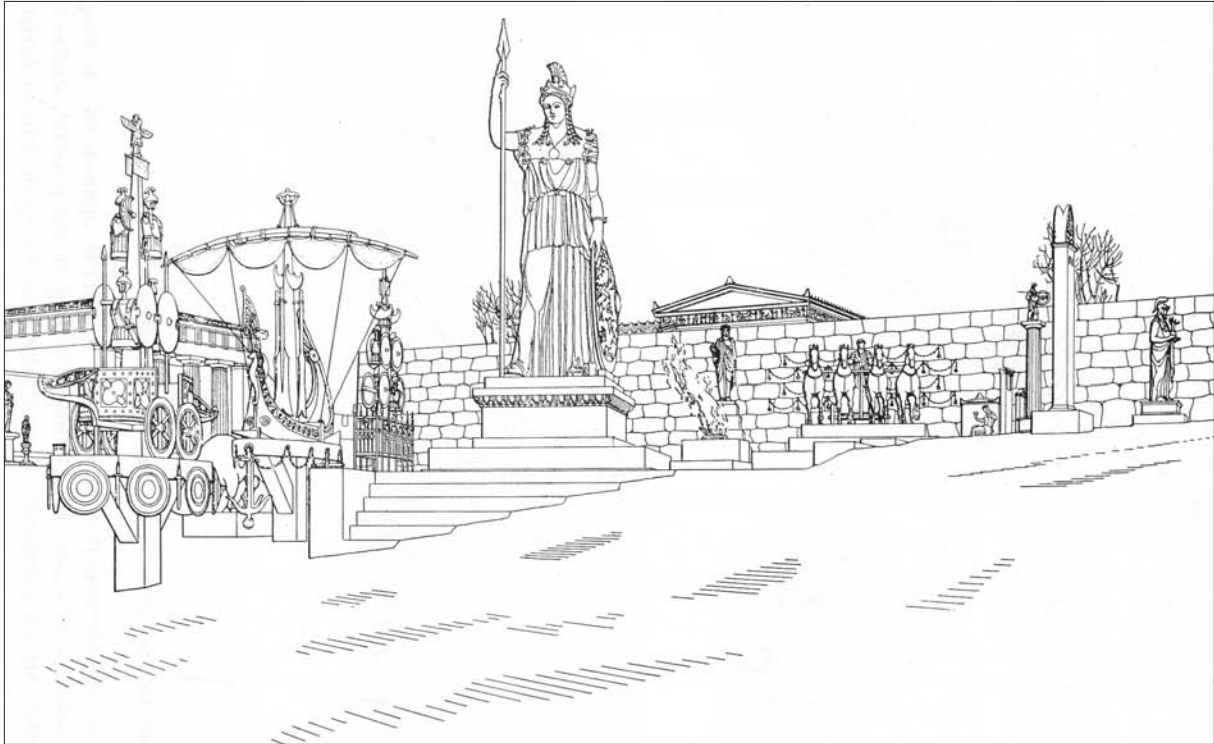

Fig. 3. Restitution of the statue of Athena Promachos (after Stevens 1936, 494, fig.44).

By the middle of the 5th century at the latest, we can reconstruct some aspects of the Athenians' emerging self-perception. The Athenians had always fought for divine order and against foreign and barbarian forces, Amazons, Centaurs, and Persians (just as Athena fought alongside other gods against the Giants). They protected the weak and defended freedom, not only their own, but also that of the Hellenes. Rightfully, then, they were the dominant power. This self-image is the predominant motif of Athenian history, or more specifically, of what the Athenians *considered* to be their history – their intentional history. It lay at the heart of their identity. And Marathon and the Persian wars were extended backwards, as it were, into what we understand as *spatium mythicum*. Thus Marathon became the crowning point of a long development: from the defensive battle against the Amazons, the battle against the Thracians allied with Eumolpus, the support of the persecuted descendents of Heracles, the assistance given to the Argives after the expedition of the Seven against Thebes, up until the victory over the Persians.

These events were repeatedly commemorated. They became a recurrent, almost canonical component of the funeral oration that was read during state memorial services for the fallen, held each year in the course of every war – almost a normal state of affairs in 5th-century Athens. They were also repeatedly represented in festivals to honour Dionysus. Many tragedies exemplify this.¹⁷ The most climactic moment, the Athenian victory over the Persians, was also condensed in an image: it was literally poured in bronze. The most important Athenian state memorial, an approximately 7-metre high bronze statue of Athena by the great sculptor Phidias (fig. 3-4), was erected on the Acropolis in the 50s.¹⁸ Equipped with her

¹⁷ See esp. Strasburger 1968, 498 ff.; Loraux 1981; Wilke 1996, 235 ff.; Meier 1988; Zimmermann 1989, 35 ff.; id. 1992², 12 ff.; cf. in general Boedeker 1998, 185-202.

¹⁸ *IG I³* 435; Demosthenes 19.272; Pausanias 1.28.2. For further evidence, see Overbeck 1868, 117 ff., the descrip-

tion by Niketas Choniates, *Chronike diegesis* p. 738 f., and the bibliography in Travlos 1971, 55 (esp. Niemeyer 1960, 76 ff.); on the iconography, see *Lexicon Iconographicum Mythologiae Classicae (LIMC)*, vol. II.1, 1984, 969 ff. and vol. II.2, 1984, 716 ff.



Fig. 4. Painting of the Athenian acropolis by Leo von Klenze (1846), Munich, Neue Pinakothek (after <http://www.pinakothek.de/neue-pinakothek/sammlung/kuenstler/kuenstler.php>).

weaponry, her spear point and helmet plumage resplendent in the sunlight, she stood on a 2-metre high pedestal. The epithet given to the goddess was Promachos, the ‘fighter in the front row’, although we are uncertain whether it was added immediately or somewhat later. It was taken as an expression of the victory over ‘the Medes, who landed in Marathon’ – to cite the periegete Pausanias. Admittedly, we do not know whether he is quoting from the inscription on the base of the statue or offering an interpretation of his own. The latter is more likely, however, since the victory at Marathon was seen as an integral part of success in the Persian wars in Pausanias’ time. Whether Marathon would have been as prominent as in the Cimonian era is rather doubtful, given that Cimon’s opponent, Pericles, was a dominant figure at the time of the statue’s erection and the artist Phidias belonged to his entourage. Pericles favoured the lower classes and they asserted themselves through their service as oarsmen. In Pericles’ time, the battle of Salamis may have stood in the foreground. That was to change, however.

4 DEBATE: THE REINTERPRETATION OF REMEMBRANCE

The victory of Marathon came to the fore again at the end of the 5th century, during the Peloponnesian war. This was no accident or coincidence. The Marathon fighters suddenly appeared – particularly in the Comedies of Aristophanes¹⁹ – not simply as champions of freedom, but rather as representatives of the

¹⁹ *Acharnes* 161. 698f.; *Clouds* 986; *Knights* 1316 ff.; *Wasps* 711; cf. now Flashar 1996. At the same time, Marathon

symbolises as *pars pro toto* the Persian wars, and Salamis is not neglected (*Knights* 779 ff.).

good old days. They represented the tried and true and were effectively juxtaposed with the increasing sense of corruption and decreasing sense of honour and shame in the modern period. Even if there is more irony concealed in Aristophanes' work than some interpretations would concede, this shows a new perspective.

My interpretation of this specific idealisation of the battle of Marathon is based upon the following observations. Reservations about democracy increased during the course of the Peloponnesian war, leading – after the Sicilian disaster – to the temporary abolition of the constitution.²⁰ In the ensuing embittered and sometimes brutal disputes, the opponents of the Periclean-type democracy did not operate under terms like 'aristocracy' or 'oligarchy', but rather sought to correct their offspring, return to the good old constitution, to the inherited order, to the *patrios politeia*.²¹ This concept was so effective that it could not be ignored, not even by the opposing side. The correction of democracy was a major consideration for the landed gentry, i.e. precisely those who could afford full armour, the hoplites. People like them had fought at Marathon, while Salamis was the glorious chapter of the *thetes*, the class which stood below the hoplite census. It is interesting to observe that the rowers of the Athenian fleet played a key role in the failure of the attempted coup. Thus the interpretation of history became completely enmeshed in the struggle between the parties in the civil war. It was also significant that Marathon was an achievement that the Athenians could claim for themselves while the League of the Greeks had fought under Spartan leadership at Salamis and Plataea – and Sparta was now an enemy.

5 RECONCILIATION: THE UNIFICATION AND GENERALISATION OF REMEMBRANCE

The highpoint of the anti-democratic movement came with military defeat in 404. With Spartan support, a junta of 30 oligarchs came to power, with the slogan of a constitution based upon the peasantry and the hoplite class. However, it remained a regime of terror, interested only in preserving personal power and increasing personal wealth. When it fell, the Athenian democracy was restored during a period of intense debate. This was in essence the democracy of Pericles, in which, however, the key term *patrios politeia* now played a key role. The restored democracy aimed at both an internal balance between the different political groups and an aggressive foreign policy. *Homonoia* and *arche* (the keywords in the title of Peter Funke's thesis)²² – i.e. 'concord' and 'leadership' – were the two leading ideas of the time.

In this climate, the more conservative interpretation of the Persian wars became the general view. In any case, in subsequent decades, we see a clear emphasis on Marathon in Athenian self-representation.²³ Although Salamis did not disappear completely, Marathon became a symbol for the Persian wars.²⁴ All the elements of the celebration of the Persian wars, as described briefly above, were now applied to Marathon. The Panhellenic and hence anti-barbarian aspect became prominent. The orator Lycurgus, one of the most vehement representatives of Athenian self-representation and one of the most successful politicians of his time, cites a distich:²⁵

'As champions of the Hellenes, the Athenians at Marathon have destroyed the power of the gold carrying Medes.'

²⁰ See esp. Lehmann 1987, 33 ff.

²¹ Cf. Gehrke 1976, 90 f. (n. 23), 96 f.

²² Funke 1980.

²³ Cf. n. 15 above; Flashar 1996, 70 ff.

²⁴ Loraux 1973, 39: 'un modèle'.

²⁵ Lycurgus 109, directly connected with the famous epigram on the Spartans who fell at Thermopylai.



Fig. 5. Reproductions of Athena Promachos and the Athenian acropolis on coins (after Lacroix 1949, pl. XXV)

‘Champions of the Hellenes’ (*promachountes Hellenon*): the Marathon warriors would certainly not have depicted themselves in this way, but their descendants did, time and again. It corresponded to their political self-perception; they founded their own identity upon this image. And therefore, the same had to be true of their predecessors. It was precisely this concept which was embodied by the powerful Athena, as protectress of the polis, the *promachos*, visible for all to see. By this time she had been indivisibly linked to the battle of Marathon.

In this way Marathon became a universal memory, largely detached from the historical event. It was transformed from a concrete set of occurrences into an extremely

diffuse image used for remembrance which, thanks to its omnipresence, lived on in the Athenian *memoria*, determining and defining the self-image of Athens. It is perhaps not a coincidence that, even after the ancient greatness of Athens had long since passed, this figure continued to impress many, including Roman emperors. Orations treated the ancient subject in new ways, monuments made it visible, and coins featuring images of Miltiades and Themistocles can be seen as illustrations of those orations, even into the 2nd century AD. Other coin types depict Athena Promachos in the most prominent position on the Acropolis (fig. 5).²⁶

To the extent that Athenian orators of the 4th century were increasingly considered models of style and were therefore canonised and imitated, their themes and *topoi*, including of course the battle of Marathon, were disseminated throughout the Graeco-Roman world. Ultimately, the battle became so de-individuated and so ideologically imbued with the connotations of freedom vs. servitude, civilisation vs. barbarity, that it could be moulded to fit other contexts.

6 RECEPTION: ATHENIAN REMEMBRANCE AS AN IDEOLOGICAL CONCEPT IN ANTIQUITY

In antiquity, we recognise two particularly telling examples of the transfer of an Athenian configuration into another, comparable context.

Attalus II, king of Pergamum, dedicated four groups of statues or reliefs on the Acropolis to Athena. These represented the battle between the gods and the giants, the Amazon battle of the Athenians, the

²⁶ Cf. the evidence quoted by Von Mosch 1996, 159 ff.; cf. also the replica of a late-classical portrait of Miltiades (Krumeich 1997, 98 f.); an example from the 2nd cen-

tury AD (with a Latin and a Greek inscription) is given by Petrakos 1996, 40 f.

battle of Marathon, and Attalus' victory over the Galatians.²⁷ Here we see not only a myth of the gods (the Gigantomachy also displayed on the Pergamum frieze) but also a historical myth (the Amazonomachy) connected with what we regard as two historical events. Moreover, we see the achievement of the Attalids set against and alongside the famous Athenian victory, thus 'mythologising' the achievement itself. The victory at the Caycos springs, exploited *ad nauseam* by the Attalids for their self-representation, is here equated to the Persian wars, as a victory of Greek civilisation over Barbarian savagery.

Even more striking is a measure taken by the youthful Roman emperor Gordian III (238–244 AD). In ideological preparation for the massive and carefully organised war which was to be waged against the new Persian empire of the Sassanids under Shapur I, in the year 242, the emperor Gordian established a new festival in Rome to honour Minerva, understood as Athena Promachos. A new cult was introduced, complete with competitions (the *Promacheia*), which were held immediately before the Janus temple was ostentatiously opened, and shortly before the emperor himself travelled to the Orient in order to restore peace by means of war.²⁸ Using keywords like *Libertas*, *Securitas* and *Virtus*, or *Pax aeterna* as immortalised on coin legends, the emperor was to defend the Graeco-Roman order against the Sassanids, who clung to the ancient traditions of the Achaemenids – the aggressors in the Persian wars. In doing so, he evoked the Athena Promachos. The traditional Athenian goddess had now become the personification of a historically unspecific figure of remembrance whose ideological significance is nevertheless unmistakable – a battle myth in the form of a god, as it were.

Thus we no longer need wonder about the story recounted by the early Byzantine historian Zosimos (ca. 500 AD). During the siege of Athens, Alaric, leading his army of Visigoths, suddenly noticed Athena Promachos on the wall: 'how one can clearly see her in her statues: armed, as if she were rushing to oppose the aggressor'. As she was accompanied by Achilles, Alaric withdrew.²⁹ Not only did the Marathon myth appear here in its divine form, it also had the effect of the divine. A myth could scarcely have had a more auspicious beginning.

7 BEYOND ANTIQUITY: THE MYTH OF MARATHON AS A MODERN FIGURE OF REMEMBRANCE

But it did not stop there. As tracing it into the modern period would take us too far, I will limit myself to a very brief sketch. Humanistic and neo-humanistic interest in the classical tradition set in motion new mechanisms of identification. These are evident in J.S. Mill's comment cited at the beginning of this paper.³⁰ He went on to say: 'If the issue of that day (i.e. the day of Marathon) had been different, perhaps the Britons and the Saxons would still be wandering in the woods'. In other words, inasmuch as European self-perception, particularly in terms of civilisation, was oriented towards classical antiquity, the Athenians at Marathon had also fought for the west and its culture. We implicitly see ourselves as the keepers of the flame, the legitimate heirs of the ancient Greeks, and we have appropriated their battle myths together with their history.

The price at which this identification came, i.e. just who was marginalised, is classically shown by Hegel's *Philosophy of history*.³¹ 'The interest of world history has been hung in the balance here. Set against

²⁷ Pausanias 1.25.1; for the bibliography see Flashar 1996, 82 f., n. 74.

²⁸ *Chronica Minora* 147 (Mommsen); Aurelius Victor 27.7; for the epigraphic evidence and the historical context see Robert 1970, 11 ff.; the ideological preparation and the organisation of Gordian's III campaign against Persia

have been thoroughly studied by Lorient 1975, 766 ff.

²⁹ Zosimus 5.6.2. Cf. Robert 1970, 15 f.

³⁰ See above, note 6.

³¹ Hegel 1970, 314 f. Further examples (including literature) in Flashar 1996, 74 ff.; cf. in general Momigliano 1979, 139 ff.



Fig. 6. The assumed burial place of the fallen Athenians at Marathon, the so-called Soros (author's photo).

one another were the oriental despotism, that is, a world united under one leader; and, on the other side, nations much more divided and much smaller in size and means, but nations which were enlivened by the free individual'. Thus, the victories of Marathon, Salamis, and Plataea were 'triumphs in world history; they have saved culture and the spiritual power and have taken away all of the strength from the Asian principle'.

This veritable metaphysical characterisation of the opposition between East and West was predetermined by the structure of ancient memory. The western intellectual tradition, with its rigorous dialectic, made a radical choice by adopting – as an element of its own identity – a mode of remembrance that comprised opposition and exclusion. In so doing, the European tradition lost touch with one of its original components; oriental history and civilisation, and Jewish culture along with them, disappeared from the European tradition to which they indisputably belong. And here we refer not only to Hegel: we could also mention the numerous scholars who explicitly or implicitly pay homage to this same dialectic.

In Greece, the situation is even simpler. With the founding of the Greek national state, the construction of a national identity placed the tradition of classical antiquity above all others. A natural identification occurred, as it were, insofar as the ancient Greeks were and are considered forefathers. Who is surprised at hearing that the battle of Marathon appears in literary works and folktales as a metaphor for battles against Turks?³² The myth of Marathon was especially nurtured during the dictatorship of the Colonels (1967-1974). The *Soros*, a prominent artificial mound on the plain of Marathon, considered to be the mass grave of the Athenians who fell in the battle (fig. 6), was transformed into a national memorial with

³² An example is given by Flashar 1996, 75.



Fig. 7. Modern start of the Marathon race at Marathon (author's photo).

the addition of various pseudo-historical adornments. Ironically, a recently published article presents very serious arguments against the interpretation of the tumulus as an Athenian grave.³³ He who scoffs at the Greek colonels, however, need only consider the localisation of the Teutoburg forest and the memorial of Hermann the Cheruscan.³⁴

And since we are talking about ironies of history, another word about the marathon, the most popular variant of modern interpretations of Marathon. Here we have a myth on two levels. In its principal elements and in numerous details (if not the Athenian relics, then at least those of the brave helpers from Plataea), we can still discern at least one historical event behind the battle myth of Marathon. But the figure of the marathon runner is pure legend. Like the first historian of the battle, contemporaries knew nothing about him. He first appears in the text of a 4th-century BC author and his story is told in various ways.³⁵ According to Lucian, who wrote about 650 years after the event itself took place, he was called Phidippides.³⁶ At the first meeting of the International Olympic Committee in 1894, the classically educated French scholar Michel Bréal, member of the Institut de France, reminded Baron Pierre de Coubertin and the assembled committee of the legendary achievement of this runner and offered a prize for a race which was to be run over the same stretch.³⁷ In this way, the marathon became part of the program of the modern Olympic Games, despite the fact that there had never been a corresponding event in antiquity (fig. 7). Even the distance did not match that from the battlefield to the centre of ancient Athens. Ever since the 1908 Olympics in London, the distance has been fixed at 42.195 km (or

³³ Mersch 1995, 55 ff.

155 ff.

³⁴ Von Elbe 1977, 106 f.

³⁷ For these and the following details see Lucas 1976, 132 ff. (with further references).

³⁵ Plutarch, *Moralia* 347 C (quoting Heraclides Ponticus).

³⁶ Lucianus, *pro lapsu inter salutandum* 3; cf. Kertesz 1991,

26 miles and 385 yards). This figure was arrived at because it corresponded to the distance from Windsor castle to the royal seats in the Olympic stadium!

From the very beginning, the event itself took on a mythical status and the victors became legends in their own time, starting with the first marathon in 1896 and the Greek herdsman Spyridon Louis.³⁸ The 'loneliness of the long distance runner', the battle – full of surprises – against opponents and one's own weakness became the stuff of new heroes who would gain a place in the *memoire collective* of modernity: the Italian Dorando Petri, for example, who in 1908 collapsed shortly before the finish line, was helped across by a referee and was subsequently disqualified, a fate which moved the world; the Korean, Kitei Son, who as a citizen of an occupied country was celebrated as a Japanese citizen in the Berlin games of 1936; the Czech Emil Zatopek, who after winning two gold medals for the 5,000 and 10,000 metres, went on to win his first marathon race; the 'Lion of Ethiopia', Abebe Bikila, who is still the only athlete to win two Olympic golds in the marathon, first in 1960 and again in 1964 (the first time running bare-foot). But it does not stop there. In recent times the glorified, and glorifying, contest of the individual has been transformed into a mass event. Today, entire legions of marathon runners, men and women alike, congregate at predetermined times in major metropolises all over the world – from Tokyo to New York, from Boston to Berlin. And last but certainly not least, there is the 'true' race which is run from Marathon to Athens.

8 CONCLUSION

All this demonstrates two things. When forged into a myth, a historical event not only becomes available for application to new situations, it also lends itself to further mythologising and adornment. This can be particularly effective because it is so much more appealing than real history. In this way, a myth can be used and reused, in completely different contexts. The marathon has become a mainstay in the world of modern sport. We celebrate and 'repeat' an event which never happened in order to pay homage to a major event about which we know next to nothing. Finally, the marathon has become a metaphor – in modern languages like German and Italian – for something that takes a long time; the story thus ends by being trivialised.

To sum up, we can say that the important historical event of the battle of Marathon became firmly anchored in Athenian ritualised memory. After a process of reinterpretation, shaped by internal politics and conflicts, the event went on to acquire a new meaning in the cultural memory of the Athenians, a meaning that far transcended the confines of the original issue. It has truly become the authoritative memorial of the Persian wars. Correspondingly, Marathon, together with the related cult of Athena Promachos, subsumed the entire range of meaning associated with the Persian wars. In this way the battle has become a symbol of identity which stands for special qualities and achievements, but also involves a contrast with the 'Other'. Because of this symbolism, the specific details have been lost. And the figure of remembrance, with all its fundamental significance, has been carried over into other contexts, thus serving identity mechanisms of a very different nature. The old, traditional figure of remembrance lends them authority, and serves as a model, allowing them to build identity in precisely those situations where it is both possible and appropriate. In this sense, history is also argument. The 'history' referred to here is not what we normally call history, but rather a multifaceted entity, one that is context-dependent yet firmly

³⁸ Incidentally, as early as 1896 a Greek girl with the lovely name of Melpomene had applied unsuccessfully to participate in the Olympic Marathon race. She is said to have run the entire distance, accompanied by cyclists, in

about four and an half hours (according to Lucas 1976, 132). It was not until the Los Angeles Olympics in 1984 that women were allowed to compete in the marathon.

fixed within the *spatium mythicum*, one that demonstrates rather than expounds, but which nevertheless is understood as history by those who see it as their specific past: it is their intentional history.

As a battle myth which establishes identity, Marathon is a figure of remembrance that contains this conflict within itself. Since the presence of an enemy is part of it, the myth serves to construct an identity which depends upon an otherness perceived as being in opposition to one's own group, community, or culture. This, in turn, allows conclusions to be drawn about the epochs and situations in which such myths are nurtured. At the same time, myth – understood as real history – becomes a symbol for exclusion or integration by means of segregation. It is precisely through participating in this process that the historian has to recall history.

REFERENCES

- Berger, P.L./Th. Luckmann, 1991: *The social construction of reality. A treatise in the sociology of knowledge*, London.
- Boehringer, D., 1996: Zur Heroisierung historischer Persönlichkeiten bei den Griechen, in M. Flashar/H.-J. Gehrke/E. Heinrich (eds), in M. Flashar/H.-J. Gehrke/E. Heinrich (eds), *Retrospektive. Konzepte von Vergangenheit in der griechisch-römischen Antike*, München, 37–61.
- Boedeker, D., 1998: Presenting the past in fifth-century Athens, in D. Boedeker/K.A. Raaflaub (eds), *Democracy, empire, and the arts in fifth-century Athens*, Cambridge (Mass.), 185–202.
- Busolt, G., 1895²: *Griechische Geschichte bis zur Schlacht bei Chaeroneia vol. II.*, Gotha.
- Castriota, D., 1992: *Myth, ethos, and actuality. Official art in fifth-century B.C. Athens*, Madison/London.
- Clairmont, C.W., 1983: *Patrios Nomos. Public burial in Athens during the fifth and fourth centuries B.C. The archaeological, epigraphic-literary and historical evidence*, Oxford.
- Delbrück, H., 1887: *Die Perserkriege und die Burgunderkriege*, Berlin.
- Doenges, N.A., 1998: The campaign and battle of Marathon, *Historia* 47, 1–17.
- Flashar, M., 1996: Die Sieger von Marathon. Zwischen Mythos und Vorbildlichkeit, in M. Flashar/H.-J. Gehrke/E. Heinrich (eds), *Retrospektive. Konzepte von Vergangenheit in der griechisch-römischen Antike*, München, 63–85.
- Francis, E.D., 1990: *Image and idea in fifth century Greece. Art and Literature after the Persian Wars*, London.
- Funke, P., 1980: *Homónoia und Arché. Athen und die griechische Staatenwelt vom Ende des Peloponnesischen Krieges bis zum Königsfrieden (404/3 - 387/6 v.Chr.)*, Wiesbaden (Historia Einzelschriften 37).
- Funke, P., 2001: Wendezeit und Zeitenwende. Athens Aufbruch zur Demokratie, in D. Papenfuß/V.M. Strocka (eds), *Gab es das Griechische Wunder? Griechenland zwischen dem Ende des 6. und der Mitte des 5. Jahrhunderts v.Chr.*, Mainz, 1–20.
- Gauer, W., 1968: *Weihgeschenke aus den Perserkriegen*, Tübingen (Istanbuler Mitteilungen. Beiheft 2).
- Gehrke, H.-J., 1976: *Phokion. Studien zur Erfassung seiner historischen Gestalt*, München (Zetemata 64).
- Gehrke, H.-J., 1994: Mythos, Geschichte, Politik. Antik und modern, *Saeculum* 45, 239–264.
- Gehrke, H.-J., 2001: Myth, history, and collective identity. Uses of the past in Ancient Greece and beyond, in N. Luraghi (ed.), *The historian's craft in the age of Herodotus*, Oxford, 286–313.
- Green, P., 1970: *The year of Salamis, 480-479 B.C.*, London.
- Hegel, G.W.F., 1970: *Vorlesungen über die Philosophie der Geschichte*, Frankfurt (Theorie Werkausgabe 12).
- Hölkeskamp, K.-J., 2001: Marathon. Vom Monument zum Mythos, in D. Papenfuß/V.M. Strocka (eds), *Gab es das Griechische Wunder? Griechenland zwischen dem Ende des 6. und der Mitte des 5. Jahrhunderts v.Chr.*, Mainz, 329–353.
- Hölscher, T., 1973: *Griechische Historienbilder des 5. und 4. Jahrhunderts v.Chr.*, Würzburg (Beiträge zur Archäologie 6).

- Ioakimidou, Ch., 1997: *Die Statuenreihen griechischer Poleis und Bünde aus spätarchaischer und klassischer Zeit*, München (Quellen und Forschungen zur Antiken Welt 23).
- Kertes, I., 1991: Schlacht und 'Lauf' bei Marathon. Legende und Wirklichkeit, *Nikephoros* 4, 155-160.
- Krumeich, R., 1997: *Bildnisse griechischer Herrscher und Staatsmänner im 5. Jahrhundert v. Chr.*, München.
- Lacroix, L., 1949: *Les reproductions de statues sur les monnaies grecques. La statuaire archaïque et classique*, Liège.
- Lehmann, G.A., 1987: Überlegungen zur Krise der attischen Demokratie im Peloponnesischen Krieg. Vom Ostrakismos des Hyperbolos zum Thargelion 411 v. Chr., *Zeitschrift für Papyrologie und Epigraphik* 69, 33-73.
- Loroux, N., 1973: 'Marathon' ou l'histoire idéologique, *Revue des Études Anciennes* 75, 13-42.
- Loroux, N., 1981: *L'invention d'Athènes. Histoire de l'oraison funèbre dans la 'cité classique'*, Paris.
- Loriot, X., 1975: Les premières années de la grande crise du III. siècle. De l'avènement de Maximin le Thrace (235) à la mort de Gordien III (244), *Aufstieg und Niedergang der Römischen Welt* II.2, 657-787.
- Lucas, J.A., 1976: A history of the Marathon race – 490 B.C. to 1975, *Journal of Sport History* vol. 3, 120-138.
- Matthaiou, A.P., 1988: Νέος λίθος του μνημείου με τα επιγράμματα για τους Περσικούς πολέμους, *HOPOS* 6, 118-122.
- Meier, C., 1988: *Die politische Kunst der griechischen Tragödie*, München.
- Mersch, A., 1995: Archäologischer Kommentar zu den 'Gräbern der Athener und Plataier' in der Marathonien, *Klio* 77, 55-64.
- Momigliano, M., 1979: Persian empire and Greek freedom, in A. Ryan (ed.), *The idea of freedom. Essays in honour of Isaiah Berlin*, Oxford, 139-151.
- Niemeyer, H.G., 1960: *Promachos*, Waldsassen.
- Nouhaud, M., 1997: Maratona, le Termopili, Salamina, in S. Settis (ed.), *I Greci. Storia-Cultura-Arte-Società II.2. Una storia greca. Definizione*, Torino, 1227-1238.
- Overbeck, J., 1868: *Die antiken Schriftquellen zur Geschichte der bildenden Künste bei den Griechen*, Leipzig.
- Petrakos, B.C.: 1996 (1995): *Marathon* (English translation from the Greek by Alexandra Doumas), Athens (The archaeological society at Athens library 155 = Ancient sites and museums in Greece 7).
- Pritchett, W.K., 1969: *Studies in Ancient Greek topography, Part II (Battlefields)*, Berkeley/Los Angeles.
- Raaflaub, K., 1985: *Die Entdeckung der Freiheit. Zur historischen Semantik und Gesellschaftsgeschichte eines politischen Grundbegriffs der Griechen*, München (Vestigia 37).
- Robson, J.M. (ed.), 1978: *Collected works of John Stuart Mill vol. XI*, Toronto.
- Robert, L., 1970: Deux concours grecs à Rome, *Comptes Rendus de l'Académie des Inscriptions*, 6-27.
- Stevens, G.P., 1936: The Periclean entrance court of the acropolis of Athens, *Hesperia* 5, 442-520.
- Strasburger, H., 1968: Thukydides und die politische Selbstdarstellung der Athener, in H. Herter (ed.), *Thukydides*, Darmstadt (Wege der Forschung 98), 498-530.
- Stupperich, R., 1977: *Staatsbegräbnis und Privatgrabmahl im Klassischen Athen*, Münster (Diss.).
- Travlos, J., 1971: *Bildlexikon zur Topographie des antiken Athen*, Tübingen.
- Von Elbe, J., 1977: *Die Römer in Deutschland. Ausgrabungen, Fundstätten, Museen*, Berlin/Stuttgart.
- Von Mosch, H.-C., Das panegyrische Münzprogramm Athens in der Kaiserzeit, in M. Flashar/H.-J. Gehrke/E. Heinrich (eds), *Retrospektive. Konzepte von Vergangenheit in der griechisch-römischen Antike*, München, 159-178.
- Wenskus, R., 1961: *Stammesbildung und Verfassung. Das Werden der frühmittelalterlichen gentes*, Cologne/Graz.
- Wilke, B., 1996: De mortuis nihil nisi bene. Elaborierte Mündlichkeit in den attischen Grabreden, in H.-J. Gehrke/A. Möller (eds), *Vergangenheit und Lebenswelt. Soziale Kommunikation, Traditionsbildung und historisches Bewußtsein*, Tübingen (ScriptOralia 90), 235-255.
- Zimmermann, B., 1989: *Dithyrambos. Geschichte einer Gattung*, Göttingen (Hypomnemata 98).
- Zimmermann, B., 1992²: *Die griechische Tragödie. Eine Einführung*, Zürich.

Multi-ethnicity and ethnic segregation in Hellenistic Babylon

R.J. van der Spek

- 1 Introduction
- 2 Multi-ethnicity in Babylonia
- 3 Evidence of the Greek community
- 4 The political institutions
- 5 Greek culture in Babylon
- 6 Conflicts between the Greek and Babylonian communities
- 7 Ethnic segregation in other cities of the ethnic world
- 8 Conclusions

Abbreviations

References

'Long live Hellas and Babylon, child of the gods.'
(Herodotus of Babylon, 2nd century BC)

I INTRODUCTION

Ethnicity is a complex phenomenon with a complex terminology.¹ Although it is impossible and unnecessary to give an overview of the modern anthropological discussion of the subject, I want to clarify my position in the discussion and specify my terminology. In the first place we must distinguish between 'ethnic group' (French *ethnie*) and 'nation.' A 'nation' is in the definition of A.D. Smith 'a named human population sharing an historic territory, common myths and historical memories, a mass, public culture, a common economy and common legal rights and duties for all members'.² *Ethnie* is defined as 'a named human population with myths of common ancestry, shared historical memories, one or more elements of common culture, a link with a homeland and a sense of solidarity among at least some of its members'.³ The main difference between nations and ethnic groups is, that in ethnic groups the link with territory may be only historical and symbolic, whereas in the case of the nation it is physical and actual.

In the modern debate about ethnicity the discussion has centred around the question whether ethnic characteristics are 'primordial' or 'situational', the question whether an ethnic identity is real and caused

¹ This article is based on a lecture given at the 48th *Rencontre Assyriologique Internationale*, held in Leiden, July 2002, which has been published as Van der Spek 2005. For a presentation of the main Greek and Babylonian evidence, the reader is referred to the appendix in that contribution. In the present article, a few important passages have been

inserted in the main text, including an overview of ethnic developments in Mesopotamian history and a paragraph on the role of the Greek authorities. I thank Mikko Kriek for drawing the maps.

² Smith 1991, 40.

³ Hutchinson/Smith 1996, 6.

by common descent, or is a subjective and situational construct.⁴ In recent literature the situational approach has become dominant.

One of the most fruitful studies in this approach is the one of the Norwegian anthropologist Fredrik Barth.⁵ He argued that it is impossible to find definite criteria for ethnicity; ethnicity is rather the result of labelling. Boundaries between ethnic groups are created, either by the group itself, or by others. So it may be that at one time the boundary mark is language, the other time it is religion, a third time it is common history. This also allows for the possibility to assign different ethnicities to one person at the same time, which leads to multiple ethnic identities. When Zinedine Zidane scores a goal for the national soccer team of France, he is a French hero, but if he fails or misses a penalty, he will be an Algerian in the eyes of the French. That is labelling by others. But people themselves may feel part of different nations. A Frisian will feel Dutch when he watches the Dutch national football team, but Frisian, when he watches the typical Frisian ball game of 'kaatsen.'

The only thing I would add to the theories of Barth, is that the criteria are not chosen at random. Language, religion, physical features, and common history are often recurring boundary marks. The notion of a common descent, though often fictitious, but mostly with a kernel of truth, always plays an important part in the perception of ethnicity.

In Antiquity, the situation was not very different. An interesting case in point is the dichotomy between Greeks and barbarians. The Greeks formed an ethnic group. They had a common proper name (*Hellēnes*), they had a myth of common ancestry (descent from Hellen), they shared important historical memories (the Trojan war, the Persian wars), they shared important elements of common culture (religion, customs, and language), they felt a link with a common homeland, Hellas, although they lived all over the Mediterranean and in the Hellenistic period far into Asia, and they more or less felt some sense of solidarity, although they were very frequently at war with each other. Moreover, the Greeks were conscious of their identity. Herodotus defined *to hellēnikon* as 'being of one blood and one language, honouring the same gods with sanctuaries and sacrifices, having the same customs (*ēthea*).'⁶ Nevertheless, in Antiquity the Greeks never formed a nation-state.

The non-Greeks were the 'barbarians', people who spoke an unintelligible language. An interesting thing is that, notwithstanding the theory of the common descent from Hellen, many non-Greeks developed into Greeks, especially in Asia Minor, and were accepted as such, a process which took centuries. The process was accelerated in large parts of Western Asia by the conquest of Alexander the Great. It created new Greeks, but also persons with a multiple ethnic identity.

Multiple ethnic identity became a striking feature of the Hellenistic and Roman periods. When the Jerusalem high-priest Jason wore Greek clothes, or sported nakedly in the gymnasium, he certainly felt Greek. When he put on his high-priestly official robes, conducted the ceremonies on Sabbath in the temple, he was the Jew Jehoshua or Jeshua. A Greek-speaking farmer in Ptolemaic Egypt may have regarded himself to be Greek, and was treated that way there, but when he travelled to the city of Alexandria, he will have been despised as a backward Egyptian. Personal names are not a clue at all. Jason of Cyrene, the author of the original, full version of II Maccabees, certainly saw himself as a Jew, but had a Greek name. Jason the high priest had two names. The apostle Paul (Saul) was a Jew from Tarsus in Turkey, who spoke Greek, and was a Roman citizen.

Ethnic labels are not for eternity. Jews and Greeks are fairly old ethnic groups; Palestinians are fairly recent (in former times they were seen as Arabs, rather than as Palestinians, but as soon as they themselves and the outside world treat them as a nation, label them as a nation, they are a nation).

⁴ Smith 1991, 20.

⁶ Herodotus, VIII 144.

⁵ Barth 1969.

Ethnic groups frequently disappear. Sumerians, Babylonians, Chaldaeans, Thracians and Batavians are lost in history. These people were not able, did not feel the need to stick to their ethnic peculiarities (which may change over time by the way). Nor did the outside world find it necessary to define certain people as Sumerians, etc. An example of this process of ethnic dissolution can be seen in Ptolemaic Egypt: in the early period, ethnic groups such as Thracians, Macedonians and Persians were still distinguished, but the terms lost their meaning first, and then disappeared all together. In the end, only Egyptians, Greeks and Jews survived.

In Ptolemaic Egypt, ethnicity did not play a very prominent role in daily life. There were different Egyptian and Greek courts, which conducted law according to Egyptian and Greek principles, but the choice of the court was not determined by ethnicity in the first place, but by the language, which the litigants (being either Egyptians or Greeks) chose for their contracts.⁷ Yet 'being Greek' could be relevant. New research has shown that 'Hellene' came to mean a person with certain minor tax privileges (tax Hellenes), although in some cases their status in a 'primordial' sense could rather be determined as Jewish or Egyptian.⁸ The Romans introduced the *laographia*, a poll tax with substantial reductions for the Greek and Roman citizens. Then it became even more important to be a Greek or Roman and to be clearly defined as such. Controversies about this ultimately led to the Jewish pogrom in Alexandria in AD 38.⁹

2 MULTI-ETHNICITY IN BABYLONIA

These things should be kept in mind when we try to discuss problems of ethnicity in ancient Mesopotamia, and Hellenistic Mesopotamia in particular. The empires of Alexander and the Seleucids were multi-ethnic states with different ethnic groups. Many people acquired a multiple identity. The Hellenistic period is, since Johann Gustav Droysen, often characterised as a period of fusion of cultures, *Verschmelzung*, and of 'Hellenisation', the spread of Greek culture over the Near East.¹⁰

Hellenistic Babylonia is a gold mine for the research into problems of ethnicity. There has been a slow process of Greek influence in Babylonia in the Achaemenid period, but there was not a slow process of 'Landnahme', a gradual occupation of land by intruders,¹¹ rather a sudden conquest. Alexander the Great took over Mesopotamia (Iraq) in 331 BC and the result of his conquest was the immigration of large groups of Greeks and Macedonians. This resulted in the foundation of new cities, such as Alexandria on the Persian Gulf, Seleucia on the Tigris, Seleucia on the Euphrates. In the older Mesopotamian cities Greeks made their entry. It is very likely that Greeks entered Babylon, Nippur, Uruk and other cities (fig. 1). I say 'likely', since our main evidence for the presence of Greeks are Greek names occurring in cuneiform documents, but, as such documents from Uruk show, it is certain that many of the people mentioned with a Greek name were in fact Urukians of a pure Babylonian origin.

Babylonia has been characterised by multi-ethnicity since millennia. The most ancient people we know of, are the Sumerians who settled there in the fourth millennium BC. Not much later the Semitic speaking Akkadians arrived. They took over the Sumerian cuneiform writing, adapted it to their own language, and adopted their religious and cultural traditions. Together Sumerians and Akkadians laid the foundation of Mesopotamian civilisation. Later other ethnic groups arrived, like the Amorites, the Kassites, the Aramaeans and Chaldaeans. Even when they took over political power, they all assimilated quickly into the Mesopotamian culture. Babylonian and Assyrian kings themselves inadvertently contributed to the creation of a multicultural society. It was their policy to deport large segments of the populations of conquered

⁷ Goudriaan 1988, 96 ff.

⁸ Thompson 2001, 306-312; cf. Clarysse/Thompson 2006.

⁹ Goudriaan 1992.

¹⁰ Droysen 1877/78; cf. Bichler 1983.

¹¹ Van Driel 2006, 3.

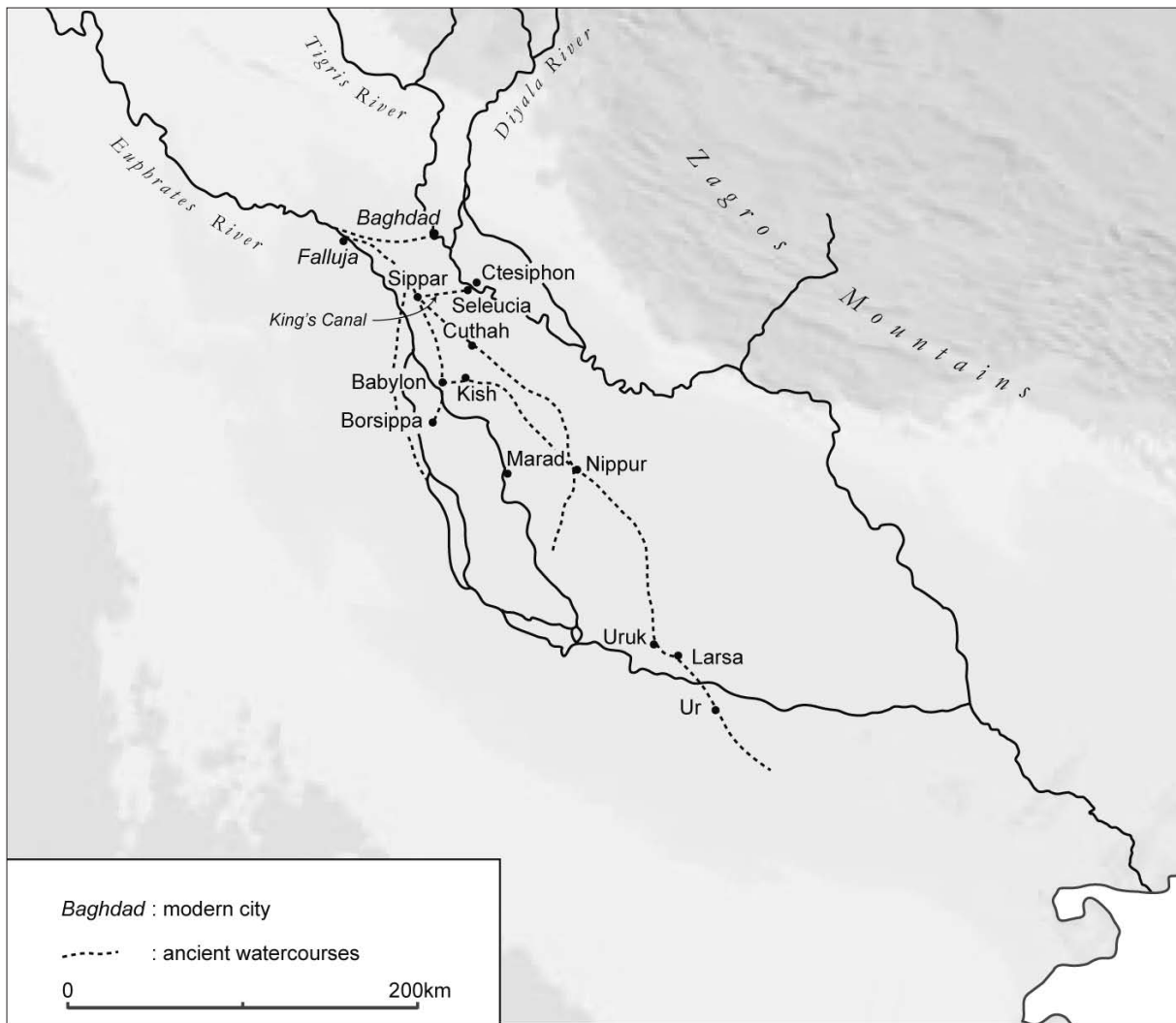

Fig. 1. Mesopotamia in the Hellenistic period. Modern place names are in italics.

areas, so that the main Assyrian and Babylonian cities were filled with foreigners. The phenomenon is nicely expressed in a letter of an Assyrian official to king Assurbanipal: ‘There are many foreign language speakers in Nippur under the aegis of the king, my lord.’¹²

In 539 BC, Mesopotamia for the first time became part of an empire – the Persian empire – that had its centre of power located outside the region. Though the Persian kings occasionally resided in the royal palace in Babylon, the core of the empire was established in Persis (Fars) in present-day south-western Iran. While the Persians also took over some elements of Mesopotamian civilisation, especially in art and architecture, they stuck to their own Persian gods like Ahura Mazda, Anahita and Mitra. They also developed their own variant of cuneiform script for monumental texts in Old Persian. However, Babylonian, Elamite and Aramaic were also used for monumental inscriptions and Aramaic became the official language of the empire. Meanwhile, Babylonia remained faithful to its own religious and cultural practices. Cuneiform Babylonian writing persisted, though the role of Aramaic, more and more the *lingua franca* of the Near East and written in an alphabetic script, became steadily more prominent. Persian functionaries appeared in Babylonia, but the Persians never carried out an extensive colonisation programme.

¹² Reynolds 2003, no. 192 rev. 6’.

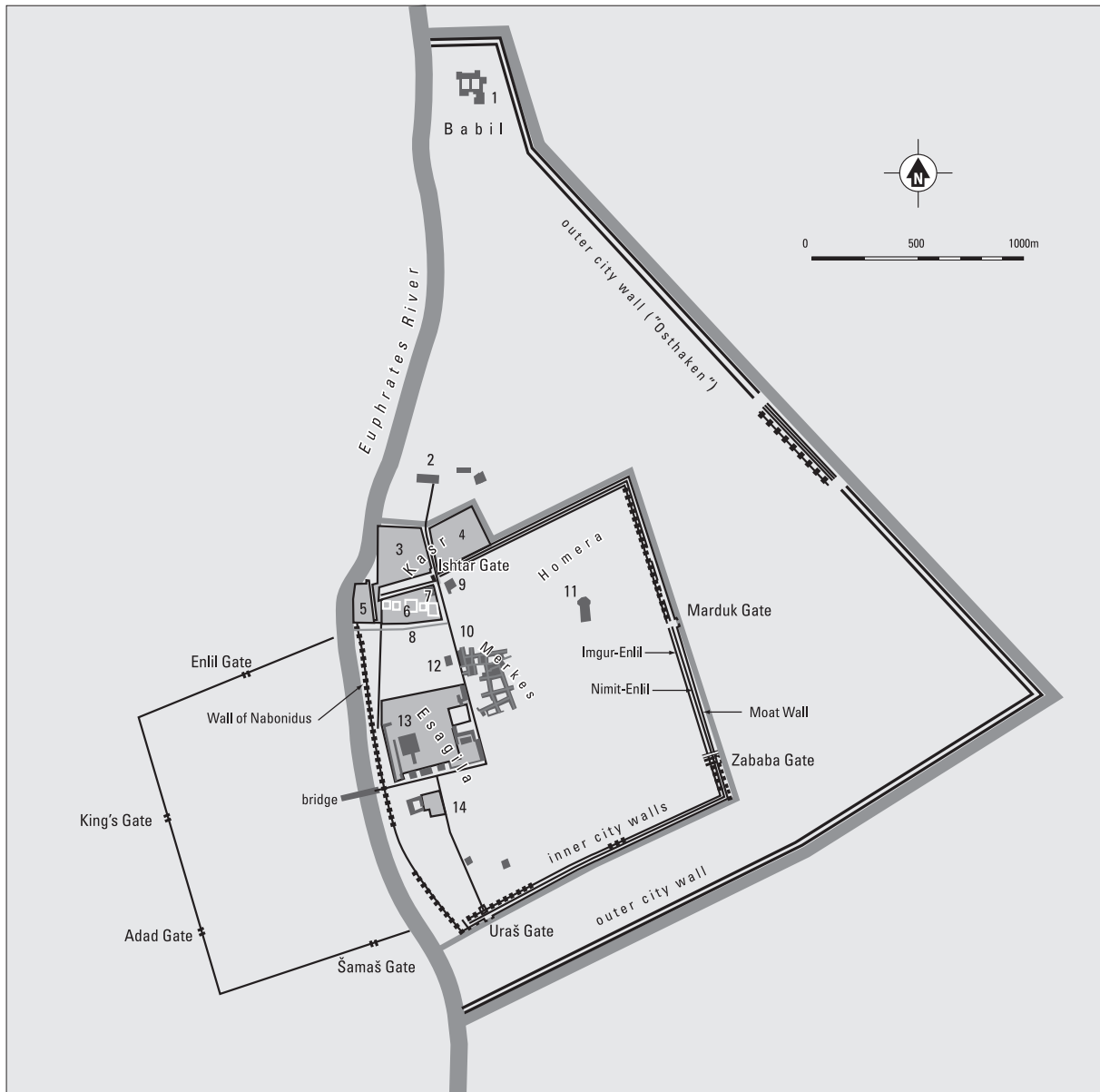

Fig. 2. Topographical map of Hellenistic Babylon.

1 Summer palace; 2 New Year's Festival temple; 3 Northern palace (Nebuchadnezzar); 4 Eastern outwork; 5 Western outwork; 6 Southern palace (Nabopolassar); 7 vaulted building; 8 Libil-hegalla Canal; 9 Ninmah temple; 10 procession road; 11 Greek theatre and gymnasium; 12 temple of Nabû-sa-harê; 13 Etemenanki temple tower; 14 Marduk temple Esagila

In 331 BC, Mesopotamia was for the first time conquered by a foreign king from the west: Alexander the Great. Alexander seems to have thought of making Babylon again the core of an empire. He died, however, in this very city, but the Macedonian and Greek presence remained. After his death, wars broke out between the generals of Alexander about the control of Alexander's conquests. Seleucus (I Nicator), appointed satrap of Babylonia in 320 BC, after a long struggle came to control the largest part of Alexander's empire, from India to Western Asia Minor, though southern Syria and Palestine remained with the satrap of Egypt, Ptolemy. In 306–305 BC, Seleucus and Ptolemy adopted the title of king and thus became the founders of the Seleucid and Ptolemaic kingdoms respectively.

The main difference between the Persian empire and the empires of Alexander and the Seleucids is that the latter started an extensive colonisation programme. The city foundations of Alexander are well known. He founded many Alexandrias, among which Alexandria in Egypt, Kandahar in Afghanistan, and Iskenderun in Turkey are the most well-known. The Seleucids continued this policy. Seleucus I first founded Seleucia, on the confluence of the Tigris and the King's Canal (i.e. the canal connecting the Euphrates and the Tigris). This was a huge city both as regards numbers of inhabitants as well as regarding its surface: it is reported to have had 600,000 inhabitants in the days of Pliny the Younger¹³ and a built-up area of 550 ha (cf. Athens: 215 ha in the classical period). It was destined to be a capital of the empire ('city of kingship' in the Babylonian documents) and it was populated by inhabitants of different ethnic backgrounds: Macedonians, Greeks, Babylonians, Syrians and Jews. Macedonians and Greeks were apparently privileged as 'citizens' (*politai*). The foundation of a new capital at Seleucia meant that the old city of Babylon lost importance, though the town's temple of Marduk and the palace of Nebuchadnezzar continued to attract Seleucid kings. Apart from Seleucia, Seleucus also founded cities in other parts of his realm, especially in northern Syria: Antioch on the Orontes (100 ha, but growing to 600 ha in the time of the emperor Tiberius), Seleucia in Pieria and Laodicea on the Sea, and Apamea on the middle Orontes.

It goes without saying that the presence of Macedonians and Greeks (the difference between these two is an interesting but difficult issue, which we cannot deal with here) was part of the new political situation, which brought a new ruling elite into Asia by force of arms, an elite which by that time had already lost its political power in Macedonia and Greece itself! Apart from the foundation of new cities, Macedonians and Greeks also settled in the old oriental cities, like Babylon, Susa and Damascus. This was partly a process of free movement, partly brought about by forced settlement.

The Macedonians and Greeks were not the last foreign rulers in Babylonia. In 141 BC an Iranian people from the east, the Parthians, took over the country. Babylonia again had to accept new overlords, and while the Greeks and indigenous Babylonians were subjected to a foreign ethnic group, the Greeks cherished their identity. Greek cities like Seleucia kept their political institutions and language and the Greek community in Susa remained a distinctive group. The attitude of the Parthian kings towards the Greeks wavered between favour and repression. They used Greek in their inscriptions and for their coin legends. Some Parthian kings called themselves *philhellēn*, 'friend of the Greeks'. On the other hand the Greeks were suspected of giving support to attempts of Seleucid kings to reconquer their lost territories.

In this paper, I wish to focus my attention on the city of Babylon (fig. 2). Many Greeks, especially soldiers, entered Babylon in 331 BC and a garrison was stationed there.¹⁴ Alexander destined Babylon to be his royal residence¹⁵ and the capital would certainly have become a Greek, or strongly Hellenised city, had he lived longer. But events took another turn for the time being. After Alexander had died in 323 BC, the wars of the Successors broke out, resulting in a victory of Seleucus I, who indeed made Babylonia the backbone of his empire, but at the same time (as Alexander had done in Egypt) founded a new city: Seleucia on the Tigris, which became 'the city of kingship'. As we saw above, Babylon remained an important city and religious centre, occasionally visited by the kings, who then would reside in the palace of Nebuchadnezzar. Antiochus III (187 BC) even took the robe of Nebuchadnezzar from the New-Year's Festival house.¹⁶ Not many Greeks, however, seem to have lived in Babylon until Antiochus IV (175-164 BC). Following a Babylonian chronicle dealing with Antiochus (I Soter), viceroy under his father Seleu-

¹³ Pliny, *NH*, VI.122.

¹⁴ Arrian, *Anabasis Alexandri* III 16.4; Sherwin-White 1982.

¹⁵ Strabo, *Geographica*, XV 3.9-10.

¹⁶ Reported in the so-called Astronomical Diaries. Astronomical diaries are daily reports made by Babylo-

nian astronomers. They contain apart from reports about celestial phenomena also records of political events, commodity prices, the level of the Euphrates and ominous events. The diaries are published by Sachs/Hunger 1988, 1989, 1996. The diary in question is *AD* II, no. -187: rev. 4'-18'; cf. Sherwin-White/Kuhrt 1993, 216.

cus I Nicator until he succeeded to the throne in 281 BC, the Macedonians who lived in Babylon under Alexander and the early successors, were deported to Seleucia on the Tigris. The chronicle says:

'[Month ..]. That month Antiochus, the crown [prince], settled [the Mace]donians, as many as there were in Babylon, [whom king Alexander² into Babylon] had forced to enter, from Babylon [into Seleucia o]n the Tigris'.¹⁷

Some evidence may confirm the deportation mentioned in the chronicle. There are hardly Greek names in the cuneiform tablets until Antiochus IV and in the architecture only few signs of Greek influence are detectable. Most Greeks of the region lived in Seleucia on the Tigris.

The situation changed radically under the reign of Antiochus IV when a Greek community was introduced into the city of Babylon. This community was given privileged political status (*politeia*), and the boundary marks of this community were of clear political nature: membership of the *politeia* or *politeuma* and the citizens were called *politai*, 'citizens'. It is difficult to assess who these people were. How Greek were they? Some criteria will have been used. They may have been veteran soldiers of different nationalities, but used to the language of command, being Greek; there may have been Greeks from the Greek world, as we shall see. Possibly also autochthonous Babylonians will have taken a new Greek name and have become members of this community. At our state of the evidence we can hardly add anything to this. What we can say is that there was a kind of 'apartheid' between the community of *politai* and the rest of the city's inhabitants. The Babylonians and the Greeks each had their own institutions and the central government communicated with both communities. This state of affairs continued into the Parthian period and is evidenced until one hundred years after the introduction of it by Antiochus IV, when, in 77 BC, the cuneiform record ends.

3 EVIDENCE OF THE GREEK COMMUNITY

In earlier publications, I already argued that Antiochus IV introduced a Greek community in Babylon.¹⁸ By lack of explicit information in the sources, the arguments had to be circumstantial. The evidence so far consisted of : 1. the Greek inscription OGIS 253,¹⁹ allegedly coming from Babylon, dated to 166 BC, naming Antiochus IV *ktistēs* ... *tēs poleōs*, 'founder of the city'; 2. the regular appearance of the term *politai*, 'citizens' (*pu-li-ṭe-e*; *pu-li-ṭa-nu* and related forms) in the Babylonian astronomical diaries from 169 BC onwards;²⁰ 3. the date (139 SE²¹ = 173/2 BC) of the so-called Lehmann-text, according to which the Babylonian citizens pleaded for their title to a land donation by the earlier king Antiochus II; they may have protested against expropriation of land in favour of the Greek colonists;²² 4. archaeological evidence for the rebuilding of the theatre in the mid-2nd century BC; 5. the occurrence of Greek names in the

¹⁷ *BCHP* 5 rev. 6-9. This Babylonian Chronicle was first published by Grayson (1975) as chronicle 11. Meanwhile Irving Finkel (British Museum) found additional fragments, which could be joined. It has now been published as *BCHP* 5 in Van der Spek 2006, 280-284 and online: <http://www.livius.org> > Mesopotamia > Babylonian chronicles.

¹⁸ Cf. Van der Spek 1986, 55-68; 1987, 65-70.

¹⁹ Cf. Sherwin-White/Kuhrt 1993, photograph nr. 7, between pp. 118 and 119; Van der Spek 2005, 402.

²⁰ Among the new Babylonian chronicles (cf. n. 2) a chronicle (*BCHP* 13) was found referring to *politai* in the 140th year of the Seleucid era (172/1 BC).

²¹ The Seleucid era (SE) starts with the conquest of Babylon by Seleucus I in 311 BC. SE year 1 begins April 311/310 BC according to the Babylonian, October 312/311 BC according to the Macedonian calendar.

²² Van der Spek 1986, 241-248 = text 11; cf. Van der Spek 1993, 69 and 76.

cuneiform sources in the very early and the later Hellenistic period; 6. the fact that Greek inscriptions from Babylon date to the reign of Antiochus IV, or (much) later, to the 2nd century AD.

None of these data may be seen as conclusive and so the introduction of the Greek community by Antiochus IV was questioned.²³ However, a recently discovered chronicle fragment in the archives of the British Museum (hitherto unpublished) mentions the introduction of the Greek *politai* by Antiochus (IV) *expressis verbis*, and sheds new light on the existing evidence. I present here a full translation.

'Year 149 (of the Seleucid era = 163/2 BC), Antiochus (V) king, month V[II, day x]. The Greeks, as they are called, the p[olitai], who in the past at the command of king Antiochus (IV) [had entered] Baby[lon] and who anoint with oil just like the pol[itai] who are in Seleucia, the royal city, on the Tigris and the King's Canal, [did] b[attle] with the prefect (šaknu) and the people of the land who are in Babylon. Day 8, at the command of the governor (pāhātu) of Babylon [the and] the women,² who among the politai, the people of the land, (and) the b[oul]ē²², from Babylon into the region below Babylon because of the battle with the [prefect and his] troop[s, had gone²,] returned into Babylon.'²⁴

Of special interest are the 'boundary marks' given by the Babylonian scribe to the new group. They are 'Greeks', *politai*, and they 'anoint with oil, just like the *politai*, who are in Seleucia, the royal city, on the Tigris and the King's Canal'. The latter expression must refer to the activities of the Greeks in the gymnasium, where they sported nakedly and anointed themselves with olive oil. Admittance to the gymnasium was normally restricted to the citizens of Greek cities and was a hallmark of Greek citizenship.

Del Monte discerns three population groups in Babylon, each with their own administrative institutions:²⁵ firstly, the Babylonian citizens (*mārē Bābili*, 'sons of Babylon') under the *shatammu* (administrative head of the temple) and *kinishtu* (council) of the temple; secondly, the Greek citizens (*puliṭē* or *puliṭānu*, a loan word from Greek *politai*), under the authority of the 'governor of Babylon' (*pāhāt Bābili* = in my view the equivalent of the Greek term *epistatēs*), and, thirdly, the royal slaves led by 'the prefect of the king'. The distinction is neatly made in an astronomical diary relating to a census held in 145 BC (king Demetrius II Nicator):

'That month, at the com[mand of A]rdaya, the general (= stratēgos) of Babylonia, they made a counting [... off the Babylonians, the slaves of the king [and of the] politai, who were in Babylon and Seleucia.'²⁶

Although Del Monte's ideas are fruitful, I do suggest a few adaptations. As a matter of fact even more population groups may be discerned, such as the 'people of the land,' probably the indigenous population living in the countryside. A fifth category is constituted by the temple slaves. In my view, the 'prefect of the king' is somehow related to the 'people of the land.' Hence he may have been the governor of the people living in the villages outside the jurisdiction of the cities, in Greek terminology designated as the *laoi* and the *laoi basilikoi* ('people of the king'). One might venture the suggestion that 'the people of the land' (*laoi*) and the royal slaves (*laoi basilikoi*) both were subject to the authority of the prefect of the king. Conclusive evidence is lacking so far.²⁷

²³ Sherwin-White/Kuhrt 1993, 158.

²⁴ *BCHP* 14. On the basis of a lacunose astronomical diary (AD II, 331, no. -187A: 9'-10'), Tom Boiy (2004, 207-209) argues that the *politai* existed in Babylon already under Antiochus III. If correct, this would make Antiochus III the king who introduced the *politai* into Babylon.

²⁵ Del Monte 1997, 38-9, 76-7, 86-7, 96-7.

²⁶ *AD* III, p. 97, No. -144: 35'-37' (Month VII 167 SE = 22 Sept. - 20 Oct. 145 BC).

²⁷ The prefect of the king may also have been the regent of the minor king Antiochus V.

In my earlier publications, I defended the idea that the Babylonian and Greek population groups each had their own political organisations and institutions. I even used the word ‘apartheid’.²⁸ The Babylonians were governed by the temple authorities, who were simultaneously the main city authorities. The head of the Babylonian community was the *shatammu*; the governing body was the *kinishtu*, which met in the *bit milki*, ‘the house of deliberation’.²⁹

If the central government wanted to communicate with the Babylonians, they wrote their letters to this institution, as is evident from the Astronomical Diary of August 94 BC: ‘[... Letters of the king, which] were written to the *shatammu* of Esagila and the Babylonians, were read in the house of deliberation in the Juniper Garden.’³⁰ From the context we may deduce that the king, the Parthian king Mithridates II, imposed heavy work obligations upon the Babylonians.

The institutions of the Greek community are not easily found, but new evidence sheds some light. In the first place the Greeks distinguished themselves as ‘citizens’ (*politai*), so they seem to have had their own *politeia*, ‘constitution’. It must be remembered though, that there is not one Greek exclusive format of a *politeia*. In the classical period the constitutions of e.g. Athens, Sparta and Corinth were very different. Normally, however, the following elements are recurring albeit under a widely differing terminology: 1. magistrates (*archontes*, *stratēgoi*, *ephoroi*, *probouloi*); 2. one or more councils (*boulē*, *synhedrion*, *gerousia*, *Areiopagos*); 3. an assembly (*ekklēsia*, *apella*, *dēmos*). The constitutions were of a different nature: Athens was democratic, Sparta and Corinth both oligarchic but nonetheless different. Furthermore, it has to be kept in mind that the Seleucid empire was ruled by a Macedonian dynasty and Macedonian institutions, like *epistatēs* (governor) and *peliganes* ([council of] ‘elders’), are attested in many places.

Though as yet no word for assembly is attested in the Babylonian sources, it is evident that the *politai* met in the theatre.³¹ That Babylon disposed of a theatre, is known since the earliest excavations of ancient Babylon at the beginning of the 20th century.³² Its existence was further proven by a 2nd-century AD Greek inscription from the theatre, mentioning its repair.³³ Recently, the Greek theatre was found in the astronomical diaries as well. From these texts, it appears that kings had letters read out loud before the *politai* being assembled in the theatre. The Greek word *theatron* was translated into cuneiform as *bit tamarti*, ‘house of observation’.³⁴

The citizens now also appear to have had their own council of elders. This council was referred to with the Macedonian name *peliganes*, which is derived from the Macedonian word *pelioi* meaning ‘old men’, *gerontes*.³⁵ This term is attested in a Greek inscription from Laodicea on the Sea, dating to November/December 175 BC, the first regnal year of Antiochus IV, containing a decision of the *peliganes*.³⁶ The name is also found in the corrupted form *Adeiganes* in Polybius V 54.10, which describes measures taken by Hermeias in Seleucia on the Tigris after the suppression of the revolt of Molon against Antiochus III. The evidence from Babylon is now found in fragments of an unpublished chronicle in the British Museum,³⁷ joined by Irving Finkel, who kindly called my attention to this document. The tablet is badly mutilated, but the same institutions as discussed above appear: ‘the *politai* and their army’ (line 7); ‘the Babylonians and the people of the land’ (line 13’), ‘the governor of Babylon’ (line 14’); ^{lú}ia-’a-man-nu, ‘Greeks’ (line 21’). Excitingly enough, the *peliganes* are also mentioned: ^{lú}pe-li-ga-na-a-n[...], ‘*peliganes*’ (with Babylonian plural) (line 3’), unfortunately in an incomprehensible context.³⁸

²⁸ Van der Spek 2001, 453.

²⁹ Van der Spek 2001, 454.

³⁰ AD III, p. 431, No. –93 A Rev. 25.

³¹ Van der Spek 2001, 447–448.

³² Cf. Mallwitz in Wetzels/Schmidt/Mallwitz 1957, 3–22.

³³ Schmidt, *ibid.*, 49–50; Van der Spek 2005, 407.

³⁴ I discussed and edited the evidence in Van der Spek 2001.

³⁵ Cf. Strabo VIII 329, fg. 2 [*epitome Vaticana*].

³⁶ Roussel 1942/43, 21–32, lines 22–23.

³⁷ BM 35189+46018+46216.

³⁸ *BCHP* 18; cf. Van der Spek 2006, 284–90.

Magistrates are not attested, apart from officials appointed by the king, like the *pahatu* in cuneiform texts and the *stratēgos kai epistatēs tēs poleōs* in a Greek inscription.³⁹ Lower officials like an *agoranomos* ('market official') and a *gymnasiarchos* ('superintendent of the gymnasium') are known from Greek inscriptions as well.⁴⁰

5 GREEK CULTURE IN BABYLON

The Greek citizens not only had their own political institutions, but also their own cultural life. As we have seen above, there was a theatre. The excavators argue that it was built in the early Hellenistic period, rebuilt in the 2nd century BC and again in the 2nd century AD. It seems likely that the building was erected under Alexander, Antigonus or Seleucus I (before 300 BC), neglected during the following years, but rebuilt under Antiochus IV. On the south side of the theatre a big Greek building was erected, which was interpreted as a *palaestra* by the excavators.⁴¹ A gymnasium existed as well. A Greek clay tablet records the winners of the Babylonian year 111/110 BC. The *gymnasiarchos* is also mentioned.⁴²

But this is not all. A stoic school was established by Archedemus of Tarsus.⁴³ He was probably a pupil of Diogenes of Babylon (ca. 240 - 152 BC).⁴⁴ Despite his name, Diogenes is reported to come from Seleucia on the basis of the evidence of Strabo, who claims that Seleucians habitually were called Babylonians.⁴⁵ However, Strabo may well have been biased and Diogenes may have belonged to the colonists settled in Babylon by Antiochus IV in 173 BC. If we may follow Plutarchus' eulogy of the spread of Hellenic culture over Asia, Diogenes was a *native* Babylonian who was persuaded by Zeno of Tarsus to study Greek philosophy.⁴⁶ However that may be, Babylon was an attractive place for a Stoic school. The holistic world view of the Stoa fitted nicely in with the holistic premisses of Babylonian astrology.

Another colonist of cultural significance was the poet and philosopher Herodicus of Babylon (2nd century BC). He is known, among other works, from a humoristic poem against a school of grammarians who were expelled from Alexandria in 145 BC, which shows his multiple identity as Greek and Babylonian: 'As for Herodicus, long live Hellas and Babylon, child of the gods'.⁴⁷

Strangely enough, we lack evidence of a Greek temple. Temples are an important part of the religious-political community. It may be surmised that a temple was built, but that this building has not been found yet. New excavations in the Homera area, in which the theatre was found, might one day show up remnants of a Greek sanctuary. Another option is that the temple of the Babylonian god Bēl was supposed to fill in the needs of the Greek Babylonians as well. Bēl was considered to be Zeus by Herodotus and the Hellenistic Greeks might have felt similarly.⁴⁸ A major problem in this view is the idea that the Greeks would have had access to the temple. One would expect then some adaptations in the cult, but the cuneiform evidence hardly provides evidence for this view. The temple authorities are entirely Babylonian and the rituals exhibit hardly Greek influences.⁴⁹ The only Greek presence is indicated by the presentations of offerings by kings and high officials (according to the instructions of the Babylonian *shatammu* and *kinishtu*) and the questionable introduction of a ruler cult. The fact that the Babylonian Astronomical Diaries often report that newly appointed 'governors of Babylon' were 'one of the *politai*'

³⁹ OGIS 254; photo Sherwin-White/Kuhrt 1993, next to p. 118, fig. 8.

⁴⁰ Haussoulier 1903 and 1909; Schmidt 1941; Rostovtzeff 1953², 451, 1431, n. 250.

⁴¹ Wetzel/Schmidt/Mallwitz 1957, 16-17; but cf. Downey 1988, 14.

⁴² Van der Spek 2005, 406-407.

⁴³ Plut., *De exilio* 14, 605B; cf. *SVF* 3, 262-264.

⁴⁴ *SVF* 3, 210-243.

⁴⁵ Strabo XVI 1.16.

⁴⁶ Plutarchus, *De Alex. Fort.* 1.5.328D.

⁴⁷ Athenaeus, *Deipnosophistae*, V 222.

⁴⁸ Herodotus, I 181.

⁴⁹ Cf. Linssen 2004 *passim*.

and that these newly appointed governors made offerings in the Esagila, the temple of the Babylonian supreme deity, to the Babylonian gods, may be a signal that the Babylonian temple was considered to be a main sanctuary for the Greek community as well. At the present state of our knowledge, I think we have to consider the question unresolved.

6 CONFLICTS BETWEEN THE GREEK AND THE BABYLONIAN COMMUNITIES

The relations between the Greek and Babylonian communities were not always friendly. Firstly, the Babylonians seem to have feared expropriation of part of their land in favour of the new Greek colonists (see above). Secondly, less than a year after the death of Antiochus IV, in the countryside downstream of Babylon fighting broke out between the *politai*, their women and their soldiers with the prefect of the king and the people of the land. The background of the conflict is hard to establish. The autochthonous Babylonian city population does not seem involved. The situation was apparently dangerous and frightful. The garrison commander, who resided in the royal palace, did not dare to go into the streets of Babylon, and the general (*stratēgos*) of Babylonia, who had fled from Seleucia, did not show up either.⁵⁰ One can hardly suppress the feeling that everything is somehow related to the anarchy after Antiochus' IV death, when the appointed regents of the minor king Antiochus V, Lysias and Philip, struggled for the regency, and Timarchus tried to become king. The matter seems to have been settled by a court session, in April 162 BC. The diary is badly mutilated, but people of the land were interrogated 'on the rack of interrogation,' some people (Babylonians?) were killed and their bodies were interred outside Babylon.⁵¹

Under Parthian rule the Greeks may have lost their privileged position, but they retained a special position. And disputes continued. In February 124 BC a quarrel arose about a royal throne. King Hyspaosines of Characene, who had usurped the throne a few months in 127 BC, had presented a throne from the royal palace to the temple of Bēl to be placed in the 'Day-One-Temple', probably the New Year's Festival House. Now 'the governor (*pāhātu* = *epistates*) of Babylon and the *politai*, who are in Babylon' took it away. It is interesting to note that the astronomer added that the Greek word for throne was *thronos* (*tu-ru-nu-us*)⁵².

In 77 BC it seems to have come to outright fighting: '*The 21st (XI 234 SE = 16 February), the substitute of the shatammu of Esagila and the Babylonians [provided] one bull and two sheep as offering [for] | That month, the Babylonians' an]d the politai carried battle equipment (and) fought against each other in the area of the temple of Nabû-ša-harē'*⁵³

⁵⁰ See the above mentioned chronicle and the Astronomical Diary of Month V 149 SE = 12 Aug. - 10 Sept. 163 BC (AD III, p. 27, No. -162 Rev. 11-17): '*That month, the politai who are in Babylon, their women, their troops [and the]ir [...] went out of Babylon. That month, the governor of the king [and the] ransacked the politai who were in the countryside. That month, the governor of Babylon (epistates²) [...]. The garrison commander² for fear of the prefect (šaknu) of the king and the people of the [and² from² the pa]llace of the king, which is in Babylon, into the city streets did not go out. That month*

the general (¹⁶gal.erín = stratēgos) of Babylonia, who [...] on the 29th day, who from Seleucia, which is on the Tigris and the King's Canal, had fled, [...] was not seen [as] before².

⁵¹ AD III, 30, No. -161 A₁₊₂ Obv. 21' - 29'; Van der Spek 2001, 448-9.

⁵² Astronomical diary Month X 187 SE = 6 Jan. - 4 Feb. 124 BC (AD III, 278, No. -124 B Rev.: 17'; Del Monte 1997, 141-3; Van der Spek 2001, 452.

⁵³ AD III, 503, No. -77 B Rev. 15'-16'.

7 ETHNIC SEGREGATION IN OTHER CITIES OF THE HELLENISTIC WORLD

Ethnic segregation is not only attested in Hellenistic Babylon. Alexander the Great founded Charax on the Persian Gulf, called it Alexandria, but took as colonists autochthonous people from Durine and veteran soldiers, who got a privileged position and separate city quarter:

*'Charax, a city on the Persian Gulf, (...), was first founded by Alexander the Great, by bringing colonists from the royal city of Durine, which then ceased to exist, and by leaving there useless soldiers. He ordered to call it Alexandria, and a district (pagus) (of it) Pellaem after his homeland, which he destined for the Macedonians.'*⁵⁴

An even more striking example comes from Hellenistic Spain. The city of Emporiae (now Empúries) was, much like modern Berlin and Nicosia on Cyprus, divided by a wall.

*'Even at that time (195 BC) Emporiae consisted of two towns (oppida) separated by a wall. One was inhabited by Greeks from Phocaea (...), the other by the Spaniards. (...) A third class of inhabitants, Roman colonists, was added by the deified Caesar, (...) and at present all are fused into one mass, the Spaniards first, and later the Greeks, having been received into Roman citizenship. (...) No Spaniard was admitted to the city, nor did the Greeks themselves leave the city without good cause.'*⁵⁵

The last example of segregation I wish to present is Jerusalem under the high-priest Jason in 175 BC, though in this case Greek political institutions are not attested and the privileged community apparently consisted of more or less Hellenised Jews. But they received some special status connected with the establishment of a gymnasium. Jason, appointed high-priest by Antiochus IV, promised to pay 440 talents of silver and

*'in addition to this he promised to pay 150 more, if permission were given to establish by his authority a gymnasium and an ephebeion for it, and to enter "those in Jerusalem" in a public register as Antiochenes.'*⁵⁶

8 CONCLUSIONS

1. Following A.D. Smith's definition of an ethnic group, there was a Greek community (*ethnie*) in Babylon. It was a named human population ('Greeks as they are called'), with myths of common ancestry, shared historical memories, one or more elements of common culture (theatre, gymnasium), a link with a homeland (cf. 'Hellas' in Herodicus' poem) and a sense of solidarity among at least some of its members. Antiochus IV (or III) introduced this community. Greeks may have lived in Babylon before, but without special status. They now received *politeia*, Greek institutions. The head was the

⁵⁴ Pliny, *NH*, VI.138, transl. Loeb Classical Library.

⁵⁵ Livy, *History of Rome*, XXXIV. 9, transl. Loeb Classical Library.

⁵⁶ II Macc. 4: 9: *kai tous en Hierosolymois Antiocheis anagrap-sai*. This is a hotly debated passage and the situation in Jerusalem is in many respects far from clear. The apparent meaning is that a section of the population in Jerusalem

(members of the gymnasium?) was set apart as a community of citizens named 'the Antiochenes in Jerusalem'. For a recent discussion, see Ameling 2003 and Kennell 2005, 15; I myself reject Ameling's and Kennell's proposition that Jerusalem received a full-fledged Greek constitution. The city remained governed by the high priest and a council of priests; no archons, *boulē* or *ekklēsia* are attested.

epistates (*pāhātu*), there was a council of elders (*peliganes*), and an assembly of citizens, the *politai* (*pulitē*). The meeting place of the citizens was the theatre. The constitution was a copy of the constitution of Seleucia on the Tigris, where there was also an *epistates* and a council of *peliganes*.

The members of this community were not necessarily only Greeks (or Macedonians) by descent. In view of the growing number of Babylonians with Greek names and double names in the cuneiform tablets, Hellenised Babylonians may well have been members too.

The king may have used land, which in the past had been given by Antiochus II to the Babylonians, for his colonisation programme. It may be the background of the request of the Babylonians that their assignments would be left untouched.

2. Greek cultural life flourished. There was a Stoic school of Archedemus; the poet Herodicus lived there. There was a theatre and a gymnasium and sport contests were held far into the Parthian period, at least until the 2nd century AD.
3. There was a Babylonian political community too. This community was headed by the *shatammu* and the *kinishtu* (*knesseth*, consisting of temple functionaries or prebendaries) of the temple(s) of Babylon. This board met in the *bit milki* (House of Deliberation) in the Juniper garden. The members are called 'Babylonians'.
4. Babylonian cultural life flourished too. The temple functioned as of old. Astronomy experienced a scientific revolution in the 2nd century BC. Cuneiform and even Sumerian was still taught in the schools. The largest temple tower ever built was not the *ziqqurat* of Nebuchadnezzar, but the one built by Anu-uballit/Nikarchos in Hellenistic Uruk. The last manuscript of the Gilgamesh epic discovered so far was written about 130 BC in Babylon.⁵⁷
5. Other categories of people may be discerned. 'People of the land' (*nišē māti = laoi?*); royal slaves (*arad šarrāni = laoi basiliko?*).
6. In political sense there was 'apartheid'. Animosity between the population groups is also attested (fights, removal of the *thronos*, controversy about land use).
7. There does not seem to have been a clear dividing line in that the two communities lived in different ghettos of the city, divided by a wall. Greek officials entered the temple and sacrificed there. Some Babylonians may have been members of both communities. The Homera area may have been the Greek quarter, but the evidence for this is scanty.

In sum: Hellenistic Babylon is an interesting case in the study of ethnicity in the context of empires. It gives an interesting insight into the effects of the so heavily debated term of 'Hellenisation'. On a broader scale, one might ask to what extent the situation of the Seleucid empire can be compared to the Roman empire. Whereas, in my view, the situation in Babylon can provide a heuristic model for the ways ethnic communities in towns of the Roman empire coexisted, one point of difference must be acknowledged. The Roman empire developed in a slow process from a medium city state in the centre of Italy into an empire that encompassed the entire Mediterranean. In this process of territorial expansion, the

⁵⁷ Space did not allow me to elaborate on this issue and provide full references. See, *inter alia*, Boiy 2004; Van der Spek 1987, 2006; Rochberg 2004, 228-236.

community of Roman citizens remained the core of the empire. This in turn created the possibility of using this citizenship in an imperial strategy. The situation in the Seleucid empire was entirely different. It emerged out of the empire of Alexander the Great, who had conquered from outside, viz. from Macedonia, the Persian empire, which had no such citizen tradition. Since the Seleucid empire did not comprise Macedonia, it had not a core comparable with Rome in the Roman empire: a clear geographical centre was lacking. The royal court had no permanent seat, but travelled through the empire to temporarily settle at dispersed royal residences, like Seleucia on the Tigris, Antioch on the Orontes, Ephesus on the coast and Sardes in the interior of Asia Minor. A universal 'Seleucid citizenship' did not exist: instead, there were many cities with as many constitutions and forms of citizenship. The kings communicated with subject communities in their respective languages and according to their traditions. In diplomatic contacts with the Greek cities, the kings developed a discourse which suited the Greek traditions,⁵⁸ in Babylon they acted as a traditional Babylonian king, in Jerusalem they dealt with the temple authorities. Their approach was regionally determined. Some kings may have furthered the Greek type of citizenship in some parts of the empire, but – in contrast to what we know from Rome – this citizenship was always tied to the city, not to the empire.

ABBREVIATIONS

ADI, II, III	Sachs/Hunger 1988, 1989, 1996.
BCHP	R.J. van der Spek/I.L. Finkel, <i>Babylonian Chronicles of the Hellenistic Period</i> , http://www.livius.org > Mesopotamia > Babylonian Chronicles
OGIS	W. Dittenberger, <i>Orientalis Graeci Inscriptiones Selectae</i> , Leipzig 1903–5.
SVF	H.F.A. von Arnim [=Joannes ab Arnim] 1968 ² [1903–1924], <i>Stoicorum Veterum Fragmenta</i> I–IV, Stuttgart.

REFERENCES

- Ameling, W., 2003: Jerusalem als hellenistische Polis: 2 Makk 4,9–12 und eine neue Inschrift, *Biblische Zeitschrift* 47, 105–111.
- Barth, F., 1969: *Ethnic groups and boundaries*, Boston.
- Bengtson, H., 1944: *Die Strategie in der hellenistischen Zeit*, 2. Band, München.
- Bichler, R., 1983: 'Hellenismus'. *Geschichte und Problematik eines Epochenbegriffs*, Darmstadt.
- Boiy, T., 2004: *Late Achaemenid and Hellenistic Babylon*, Leuven.
- Bunge, J.G., 1976: Die Feiern Antiochos' IV. Epiphanes in Daphne 166 v.Chr., *Chiron* 6, 53–71.
- Clarysse, W./D.J. Thompson, 2006: *Counting the people in Hellenistic Egypt*, Cambridge (2 vols).
- Del Monte, G.F., 1997: *Testi dalla Babilonia Ellenistica*, vol. I. *Testi Cronografici*, Roma/Pisa.
- Droysen, J.G. 1877/78, *Geschichte des Hellenismus*, Gotha.
- Goudriaan, K., 1988: *Ethnicity in Ptolemaic Egypt*, Amsterdam.
- Goudriaan, K., 1992: Ethnical strategies in Graeco-Roman Egypt, in P. Bilde *et al.* (eds), *Ethnicity in Hellenistic Egypt*, Aarhus, 74–99.
- Grayson, A.K., 1975: *Assyrian and Babylonian Chronicles*, Locust Valley (NY).
- Haussoulier, B., 1903: Inscriptions grecques de l'Extrême-orient grec, *Mélanges Perrot: recueil de mémoires concernant l'archéologie classique, la littérature et l'histoire anciennes dédié à Georges Perrot*, Paris, 155–159.

⁵⁸ See, for an excellent study of this discourse, Ma 1999.

- Haussoulier, B., 1909: Inscriptions grecques de Babylone, *Klio* 9, 352-363.
- Hutchinson, J./A.D. Smith (eds.), 1996: *Ethnicity*, Oxford.
- Kennell, N.M., 2005: New light on 2 Maccabees 4: 7-15, *Journal of Jewish Studies* 56, 10-24
- Ma, J., 1999: *Antiochos III and the Cities of Western Asia Minor*, Oxford.
- Reynolds, F. (ed.), 2003: *The Babylonian Correspondence of Esarhaddon and Letters to Assurbanipal and Sin-šarru-iškun from Northern and Central Babylonia*, Helsinki (State Archives of Assyria 18).
- Rochberg, F., 2004: *The Heavenly Writing. Divination, Horoscopy, and Astronomy in Mesopotamian Culture*, Cambridge.
- Rostovtzeff, M., 1953² (1941): *The Social and Economic History of the Hellenistic World*, Oxford.
- Roussel, P., 1942/43: Décret des péliganes de Laodicée-sur-Mer, *Syria* 23, 21-32.
- Sachs, A.J./H. Hunger, 1988: *Astronomical Diaries and Related Texts from Babylonia*, Vol. I. *Diaries from 652 B.C. to 262 B.C.*, Vienna.
- Sachs, A.J./H. Hunger, 1989: *Astronomical Diaries and Related Texts from Babylonia*, Vol. II. *Diaries from 261 B.C. to 165 B.C.*, Vienna.
- Sachs, A.J./H. Hunger, 1996: *Astronomical Diaries and Related Texts from Babylonia*, Vol. III. *Diaries from 164 B.C. to 61 B.C.*, Vienna.
- Schmidt, E., 1941: Die Griechen in Babylon und das Weiterleben ihrer Kultur, *Archäologische Anzeiger* 56, 786-844.
- Sherwin-White, S., 1982: A Greek ostrakon from Babylon of the early third century B.C., *Zeitschrift für Papyrologie und Epigraphik* 47, 51-70.
- Sherwin-White, S./A. Kuhrt, 1993: *From Samarkhand to Sardis. A new approach to the Seleucid empire*, London.
- Smith, A.D., 1991: *National Identity*, Harmondsworth.
- Tarn, W.W. 1951²: *The Greeks in Bactria and India*, Cambridge.
- Thompson, D.J., 2001: Hellenistic Hellenes. The Case of Ptolemaic Egypt, in I. Malkin (ed.), *Ancient Perceptions of Greek Ethnicity*, Washington/Cambridge Mass., 301-322.
- Van der Spek, R.J., 1986: *Grondbezit in het Seleucidische rijk*, Amsterdam.
- Van der Spek, R.J., 1987: The Babylonian city, in A. Kuhrt/S. Sherwin-White (eds), *Hellenism in the East*, London, 57-74.
- Van der Spek, R.J., 1993: New evidence on Seleucid land policy, in H. Sancisi-Weerdenburg (ed.), *De agri cultura. In memoriam Pieter Willem de Neeve (1945-1990)*, Amsterdam, 61-77.
- Van der Spek, R.J., 2001: The theatre of Babylon in cuneiform, in W.H. van Soldt (ed.), *Veenhof Anniversary Volume. Studies presented to Klaas R. Veenhof on the occasion of his sixty-fifth birthday*, Leiden, 445-456.
- Van der Spek, R.J., 2005: Ethnic segregation in Hellenistic Babylon, in W.H. van Soldt/R. Kalvelagen/D. Katz (eds), *Ethnicity in Ancient Mesopotamia. Papers read at the 48th Rencontre Assyriologique Internationale, Leiden, 1-4 July 2002*, Leiden, 393-408.
- Van der Spek, R.J., 2006: The size and significance of the Babylonian temples under the successors, in P. Briant/F. Joannès (eds), *La transition entre l'empire achéménide et les royaumes hellénistiques. Actes du colloque organisé au Collège de France par la 'Chaire d'histoire et civilisation du monde achéménide et de l'empire d'Alexandre' et le 'Réseau International d'études et de recherches achéménides', 22-23 novembre 2004*, Paris (Persika 9), 261-307.
- Van Driel, G., 2006: Ethnicity, how to cope with the subject, in W.H. van Soldt/R. Kalvelagen/D. Katz (eds), *Ethnicity in Ancient Mesopotamia. Papers read at the 48th Rencontre Assyriologique Internationale, Leiden, 1-4 July 2002*, Leiden, 1-10.
- Wetzel, F./E. Schmidt/A. Mallwitz, 1957: *Das Babylon der Spätzeit*, Berlin.

The Galatians in the Roman Empire: historical tradition and ethnic identity in Hellenistic and Roman Asia Minor

Karl Strobel

- 1 Introduction
- 2 Historical and ethnic identity and self-confidence
- 3 The settlement and ethnogenesis of the Galatian peoples in Asia Minor
- 4 The cities of Roman Galatia –Ankyra, Pessinus, Tavium– and the continuity of historical identity
- 5 The population of Roman Galatia: shared traditions, values, and religious thoughts
- 6 The Galatian aristocracy: historical identity and the ‘impact of Empire’
- 7 Epilogue

Abbreviations

References

I INTRODUCTION

An exceedingly important phenomenon in the history of Early Hellenistic Central Asia Minor is the immigration and settlement of Celtic tribal groups and the formation of three tribal states, the first steps of which took place in 274/272 BC.¹ These events changed the political and geographical landscape of ancient Central Anatolia leading to the establishment of the new historical country of Galatia. Superimposed on parts of the territories of Phrygia and Cappadocia,² Galatia quickly formed its own ethnic and linguistic identity and tradition (cf. fig. 1).³ After the early sixties of the 3rd century BC, the three tribal states of the Tolistobogioi, the Tektosages and the Trokmoi were permanently established in Central

¹ This paper has also been published, in slightly different versions, in German, as Strobel 2007a, 2007b. For a more detailed account, see Strobel 1994b, 1996, 2002a, 2002b; idem, *DNP* 4, 1998, 742–745, *s.v.* Galatia; *DNP* 6, 1999, 393–400, *s.v.* Kelten. Arslan 2000, the first description of the Galatians in Turkish, collected the sources often without critical analysis and summarises older positions and newer approaches indiscriminately; he takes account of historical research beyond his subject only to a limited extent. For critical remarks on Mitchell 1993 and Darbyshire/Mitchell 1999, cf. Strobel 1996, 71 ff.; idem 2002a, 2000b. Darbyshire/Mitchell/Vardar 2000 make important corrections and now nearly completely follow my main argumentation. Birkhan 1997, 130 ff. is largely

based on Tomaschitz’s dissertation (now Tomaschitz 2002) and is only reliable to a certain extent; he does not go deeper into the question of sources and historical matters and considers the archaeological material for the East insufficiently. Tomaschitz is often indebted to older concepts, especially those of his teacher G. Dobesch.

² Cf. Strab. 2, 5, 31, where (Inner) Phrygia, the part belonging to the Galatians, is named Galatia (with an unequivocal definition: Galatia of the *Gallograeci*); 12, 3, 9; 12, 8, 1; Plin., *NH* 5, 146 (cf. Strobel 1996, 254 ff.); Arrian. *an.* 2, 4, 1 (Ankyra designated as ‘Galatian’). For the *Galatiké chōra* in contrast to other parts of the Roman province of Galatia, *Acts* 16, 6; 18, 23.

³ Cf. Strobel 1996, 117 ff.; idem 2002a.

Anatolia. The relatively small groups of Celtic immigrant settlers were to leave their mark on the spoken language and the historical identity of the people living in this central part of Anatolia for around eight centuries. This extraordinary historical process was based on the specific hierarchical and well-developed social structures of the Celtic immigrant groups as well as on value systems shared by the whole population in this region.⁴ These factors constituted the favourable conditions for the long lasting vitality of the new Galatian identity and ethnic-historical tradition. At this point, it may be important to note that there was never anything like a La Tène culture or a Laténised regional culture in Asia Minor. La Tène objects dating from the 3rd and 2nd century BC which are found in Anatolia and south-eastern Turkey are clearly to be associated with Celtic mercenaries serving in the armies of the Hellenistic kings and the Attalids of Pergamon, whereas the younger group of objects must be associated with mercenaries of King Mithradates VI Eupator of Pontos.⁵

After the 3rd century BC, Hellenisation had a profound effect on the cultural structures of Galatia. Specific archaic rituals like the sacrifice of human beings, which is now well documented in the Galatian sanctuary at Gordion prior to its destruction in 189 BC,⁶ ceased to exist in the mid-2nd century BC; the last mentioning of a ritual sacrifice of prisoners dates back to the Galatian struggle for existence, and freedom from Pergamon in 168/166 BC.⁷ The heroic fighting tradition of Celtic elite warrior bands, which was based on religious and ritual traditions, is attested for the last time in 189 BC, when a corps of elite warriors of three of the four Tolistobogian tetrarchies⁸ still fought naked against the army of Cn. Manlius Vulso in the battle of *Mons Olympus*.⁹ Military equipment in La Tène tradition, which is only documented on the triumphal monuments of Pergamon, seems to have finally disappeared early in the first half of the 2nd century BC. The Galatian aristocracy was already integrated into the international diplomatic network of Asia Minor in the first half of the 2nd century BC, based on the principles of mutual friendship (*philia*) and of hospitality (*proxenia* and *epixenoma*).¹⁰ From that time onwards, the Romans considered them *Gallograeci*, i.e. a degenerate mixture of Gauls and peoples of Asia Minor, who pretended to be Celts, as formulated splendidly in Livy based on the annalistic tradition available to him,¹¹ but who in reality seemed to be Anatolians or ‘Greeks’. The Romans – and also Strabon – thus used the terms *Gallograeci* and *Gallograecia* to characterise the cultural habit of the Galatians, expressing thereby that to them they were primarily Hellenised Anatolians and not, despite their claims, Gauls.

⁴ Cf. also Darbyshire/Mitchell/Vardar 2000.

⁵ Cf. Strobel 1996, 184 ff.; idem 2002b, 259 ff. The new La Tène fibula from Gaziantep published by F. Bulgan and M. Feugère (*Bulletin Instrumentum* 20, December 2004, 17) can be associated with the Celtic mercenaries of Antiochos III. Darbyshire/Mitchell/Vardar 2000, 83 ff. wrongly assume that objects belonging to the La Tène civilisation describe the specific material culture of the Galatians of Asia Minor. Their postulation of a ‘European’ cultural identity of the ‘European’ Galatians remains problematic. Ethnic identity cannot be analysed in material culture (cf. Wenskus 1977, 113 ff.). For the Hellenistic settlement of Gordion see below.

⁶ Cf. Strobel 2002b, 250ff; idem 2002c; Dandoy/Selinsky/Voigt 2002.

⁷ Diod. 31, 13: ‘The general of the barbarous Galatians ... gathered the prisoners together and perpetrated an act of

utter inhumanity and arrogance. Those of the prisoners who were most handsome in appearance and in the full bloom of life he crowned with garlands and offered in sacrifice to the gods ... all the rest he had shot down, and though many of them were acquaintances known to him through prior exchanges of hospitality, yet no one received pity on the score of friendship’.

⁸ Liv. 38, 18, 1.14–15. One of the Tolistobogian tetrarchs remained neutral and in friendship with Pergamon.

⁹ Liv. 38, 21; cf. Strobel 1994b; Birkhan 1997, 115 f., 950 ff.

¹⁰ Cf. Diod. 31, 13; F. Gschnitzer, *RE Suppl.* 13, 1973, 629–730, s.v. Proxenos; D. Kienast, *RE Suppl.* 13, 1973, 581–587, s.v. Presbeia (§ 19).

¹¹ Cf. Liv. 38, 17, 9 f. (*mixti, et Gallograeci vere, quod appellantur*); 38, 17, 13 (*Phrygas igitur Gallicis oneratos armis*); 48, 46, 1. Cf. Strab. 2, 5, 31; Caes., *BC* 3, 4, 5; Strobel 1996, 124.

In this paper, the processes of Hellenisation and acculturation within the regional culture of Asia Minor will not be dealt with in any detail as they have already been discussed in several other contributions.¹² The main focus here will be on the long lasting effects of the ‘Galatisation’ of Central Anatolia. We must be aware that the term *Galatai* is used in Greek sources as a general designation for the Celts, for Celtic groups of people everywhere and even for groups that were only marked as such by their ancient contemporaries.¹³ In the present paper, however, the name ‘Galatians’ is used in a stricter sense, referring only to the three Galatian peoples in Asia Minor. The collective name of *Galatai* was originally used for the designation and self-designation of Celtic warrior bands. As such the name was not only used by ancient authors, but also by themselves, as is attested in the honorific inscription for Brogitaros and in the funerary inscription from Tumulus B at Karalar, erected for Deiotaros II Philopator, son and co-regent of Deiotaros I Philorhomaios.¹⁴ In the latter inscription both father and son bear the title king as well as the title tetrarch of the *Galatai Tolistobogioi* and (*Galatai*) *Trokmoi*. The last Galatian ruler, King Amyntas, son of Dyitalos, designated himself too as tetrarch of all Galatians.¹⁵ The kingship of the last Galatian rulers was a separate majestic dignity beyond the traditional social and political order of the Galatian tribes. Although the dignity was only given by the authority of Rome on an individual basis, the title *tetrarch* remained the traditional designation of the ruling Galatian princes.

As stated above, the main focus of the present paper is the crucial transition of the Galatians into the vast Roman province of Galatia, created by Augustus in 25/24 BC when he annexed all the territories of King Amyntas who had been killed by the Homonadeis during his war in Pisidia.¹⁶ Since 166 BC, when Rome granted and guaranteed autonomy and freedom from Attalid domination, the Galatians were loyal allies of the Romans.¹⁷ During the First Mithradatic war (89–85 BC), Mithradates VI Eupator, king of Pontos, massacred most members of the tetrarchic aristocracy in Pergamon. Pompeius finally established a new political leadership ruling over the three tribal states: Deiotaros I over the Tolistobogioi, Brogitaros over the Trokmoi, while the Tektosages, initially divided into two tetrarchies, were later united under the rule of Kastor Tarkondarios. After removing all his rivals, Deiotaros I managed to become tetrarch of all Galatians at the end of his reign. His successors, Kastor and Amyntas, were enthroned by Marcus Antonius.

Against this background, the question here is how the historical tradition and ethnic identity of the Galatians continued after they had lost their political independence and were incorporated into the Roman administrative organisation. According to Stephen Mitchell’s definition, ethnicity is based on the perception of differences; it is seen as the attribute of smaller geographically circumscribed communities that differ in one way or another from the dominant culture.¹⁸ Regarding Asia Minor, Mitchell argues

¹² See my contributions cited above, note 1.

¹³ Cf. Strobel 1996, 123 ff. on the name *Galatai* and the different modern definitions of Celts; the term ‘Celtic’ is used here in a modern scientific sense based on the criterion of spoken Celtic language or language-dialects. Neither the Hallstatt culture nor the La Tène culture can be equated with the definition of ‘Celts’. Cf. also Darbyshire/Mitchell/Vardar 2000, 77 f.; Birkhan 1997, 32 ff., whose explanation of the name ‘Galatian’ (p. 47 ff.) is not convincing.

¹⁴ OGIS 349; French 2003, no. 1.

¹⁵ Inscription from Bayat, published in Mitchell 1994.

¹⁶ Cf. Mitchell 1994.

¹⁷ Cf. K. Strobel, in prep.; for Pompeius’ new order, cf. Appian, *Syr.* 11, 8, 50.

¹⁸ Mitchell/Greatrex 2000; cf. Mitchell 2000 (based on the

concept of ascribed status). More convincing is Eriksen (2002, 4) for whom ethnicity ‘refers to aspects of relationship between groups which consider themselves and are regarded by others as being cultural distinctive’. Hall 2002 tries to differentiate between ethnic identity (‘self-consciousness of belonging to an ethnic group’) and ethnicity (‘primarily descent-based’); for McInerney (2001) ethnicity is ‘the sense of peoplehood arising from shared blood, history, territory, language, and customs’. Cf. also the contributions in Malkin 2001. For the formulation of the concept of ethnicity, cf. Glazer/Moynihan 1975; for the development of the terminology, Heinz 1993; for the specific problems of ethnic interpretation in archaeology and especially the construction of ethnic identities, Brather 2000 (esp. 158 ff., 160 ff.); 2002; 2004.

that the local sense of identities which did not correspond to the administrative boundaries of imperial government vanished over time, because of the new reality constructed from above, i.e. the general categories of identity – Roman and Greek, and later Christian, i.e. so-called ‘ascribed statuses’. The result in the case of the Galatians would have been that their historical identity – which always included ethnic and cultural identity –, should have vanished after the end of the Galatian polity. Since this was not the case, Mitchell’s model appears to be insufficient for our discussion.¹⁹ Nico Roymans emphasises more convincingly: ‘Ethnic identities are by definition subjective, dynamic and situational constructs... they relate to a collective of people who — in interaction with their self-image and the picture that others construct of them – formulate and use rules of belonging, role filling and exclusion’.²⁰

In what follows, we will consider the different aspects of historical, ethnic, linguistic and cultural identity first, and emphasise the importance of language in our context (section 2). Next, we will summarise the settlement of the Celtic immigrants and the ethnogenesis of the historical Galatian tribes in Asia Minor (section 3). After having discussed the expression of identity in the autonomous Galatian cities that were established during the organisation of the new Roman province of Galatia (section 4), we will examine the homogeneous amalgam of the population – which shared identities, value systems, and religious beliefs and practices – and discuss the evidence for continuity of ethnic and historical traditions in the former Galatian territories within the Roman province (section 5). Finally, a discussion of the historical identity within the social elite of Roman Galatia follows.

2 HISTORICAL AND ETHNIC IDENTITY AND SELF-CONFIDENCE

Contrary to popular understanding, there was never one common Celtic identity.²¹ Only historical identities of a single people, of a single constituent tribal group or of a single ‘clan’ existed. These identities were based on common traditions and ‘histories’ and on shared social and mental codes, which provided the essential instruments for the historical and ethnic self-confidence of the group and its members. All ethnic and cultural identities only exist at a certain point in time as specific forms of time-referenced and thus historical systems.²² Ethnic identity is the mental self-attribution to an ethnic tradition which

¹⁹ The question of losing ethnic differentiation in middle Byzantine times is beyond the scope of this paper.

²⁰ Roymans 2004, 1 ff.

²¹ For the approaches and models of ethnogenesis, acculturation, ethnicity and ethnic identity, cf. the contributions in the following edited volumes: Barth 1969 (esp. Barth 9 ff.); *Studien zur Ethnogenese* 1985; *Geschichtliche Grundbegriffe* 7, 1992, 141–431, s.v. Volk, Nation (R. Koselleck 141 ff.; F. Gschnitzer 151 ff.); Kamber/Moser 1984; Fischer 1992, esp. 47 ff., 61 ff. (W. Rudolph); Brunner/Merta 1994 (W. Pohl); Pohl/Reimitz 1998; somewhat problematic is Gillett 2002 (not convincing are the contributions by W. Goffart, A.C. Murray 39 ff., M. Kulikowski, and C.R. Bowlus); cf. also Assmann 2000, 144 ff. (chapter ‘Ethnogenese als Steigerung der Grundstrukturen kollektiver Identität’). For different aspects of specific models, cf. Mühlmann 1964; Thiel 1977; Geary 1983; Eriksen 2002;

Roymans 2004, 1 ff. The German language research on ethnogenesis is almost totally ignored in the contributions in Mitchell/Greatrex 2000. Some aspects of the discussion of ethnicity based on theoretical anthropological models have already developed into ‘self-fulfilling prophecies’. The controversial diversity of theoretical approaches shapes, for example, the discussion by Hall 2002; cf. the contributions in *Ancient East and West* 4/2, 2005.

²² Cf. Strobel 1996, 139 ff.; 2002b, 234 ff.; Assmann 2000, 130 ff., 144 ff.; Pohl 2004a, 7 ff., 45 ff.; 2004b; H. Castritius, *RGA*² 29, 2005, 508–515, s.v. Stammesbildung, Ethnogenese; in general, Wenskus 1977 (esp. 14 ff., 59 ff., 130 ff.); idem 1986; Heckmann 1992, 30 ff.; Rübekeil 1992, 11 ff., 22 ff., 29 ff.; Wolfram 1997, 20 ff., 63 ff.; 1998; Pohl 1998a; 1998b; 2002; Frank 2002. For the importance of onomastic traditions as a reflection of a *Bewußtseinsgemeinschaft*, cf. below note 29.

is always defined by its history and only exists in its historical dimension. It is founded on the awareness of, and the conscious affiliation with, a collective tradition based on myths, a shared past and the notion of a common origin,²³ and becomes manifest in oral traditions, ritual acts, common symbolic codes and values, common customs and in a shared tradition of language. As a form of human self-definition, ethnicity becomes manifest in the expression and communication of contrastive differences between individuals and groups which consider themselves to be distinctive in terms of tradition, self-representation and specific elements of culture. As with all social groups, the formulation of boundaries as a means of self-definition by a binary opposition between 'us' and 'them' is fundamental. These boundaries, which were created by a mutual process of self-attribution and external attribution by 'others', are crucial for the self-confidence of the members of the ethnic group.²⁴

Boundaries of culture and ethnic identity do not coincide. Just as ethnic identity can be preserved in spite of cultural changes and dominating cultural influences, cultural contents can vary without any critical consequence for the maintenance of the ethnic group and its defining boundaries. Continuity of ethnic identity is not to be equated with a continuity of culture or even material culture. In this context, the ethnic self-designation, the '*Volksname*' as a marker of self-identification, is of great importance. Here, the Galatians in Asia Minor provide an important example. Gregorios of Nazianzos, Basilios of Caesarea, Ammianus Marcellinus or Hieronymus in the 4th century AD.²⁵ and the author of the *vita* of Theodoros of Sykeon in the mid-7th century AD²⁶ took the existence of a specific identity of the Galatians in Asia Minor for granted, and to be well-known to their audience. However, at this point in time, any cultural differences with the people in the neighbouring regions had long ceased to exist, except for the use of the Celtic language which continued until well into the 6th century AD.²⁷ Clearly, the maintenance of a shared language and language tradition is the most important factor for the survival of an ethnic community or its identity, especially in a foreign cultural and linguistic environment and in the confrontation with a culturally dominant language, in our case Greek.

Above all, identities are based on, and consist of, symbolic codes or languages, on the coding, transmission and decoding of information. Fundamental to the whole self-understanding and self-imagination of the human being is his ability to create symbols and to use the media of symbolism in all its variations.²⁸ The abilities to speak, to communicate through dialogues, and to construct rituals and ritual codes are

²³ Cf. Assmann 1999; 2003; Assmann/Friese 1998, esp. 269 ff. (K.-H. Kohl); Assmann 2000, esp. 130 ff.

²⁴ Cf. esp. Barth 1969, 9–38, esp. 15, 18, who emphasises the importance of ethnic demarcation and of maintaining these boundaries in interaction with other groups.

²⁵ Greg. Naz., *or.* 22, 12; Basil., *epist.* 207, 1; Basil., *c. Eun.* I 128–129; 131; 205 (ed. W. Jaeger, Leiden 1960); Amm. 22, 7, 8; Hieronymus, *comm. in ep. ad Galat.* 2, praefatio; cf. also Greg. of Nyssa, *epist.* 20 (cf. Strobel 1996, 121 note 22).

²⁶ Cf. esp. v. Theod. 50, 12–19.

²⁷ Cf. esp. Strab. 12, 5, 1; Hieronymus, *comm. in ep. ad Galat.* 2, 3, 429–430 (Migne PL 26, 356 ff.): *Galatas excepto sermone Graeco, quo omnis Oriens loquitur, propriam linguam eandem paene habere quam Treviros*. Cf. Strobel 1996, 139 ff. Freeman 2001 only provides a chrestomathy of passages from ancient sources relating to the Galatians and their language and a list of onomastic data; his historical

assumptions are often problematic and the necessary differentiation between the Galatians of Asia Minor and the generally used term *Galatai* is not made.

²⁸ The basic importance of language, language tradition, and of symbolic language in general is emphasised in modern semiotics, linguistic semantics, cognitive psychology, neurocognition, in neurolinguistics and in the theories of communication and symbols, and in media sociology. Cf. the fundamental remarks in Wittgenstein 2001; Cassirer 1985, 1996, 2001, 2002, 2003; Whitehead 2001. For a discussion of these approaches, cf. Assmann 1998, 2003, 2004; Assmann 2000, esp. 130 ff., 144 ff.; Schwemmer 2000; Margreiter 1997; Melville 2001; Tomasello 1998/2003; in general Posner/Robering/Sebeok 1997–2004; Posner 2004; also Sachs–Hombach/Rehmämper 2004. For the approaches of Ernst Cassirer, cf. Orth 2004; Hamlin/Krois 2004.

inseparable from the notion of the symbolic. Speech and the processing of language, memory, cognitive rituals, ritual acts, and symbolic signs build the specific networks which enable human beings to communicate, to act and to develop individual and collective orientation. Social systems of all kinds and sizes are based on a common symbolic language and symbolic tradition. Decisive is the accepted and consensual use of specific codes, language included, as media of communication within the community and, at the same time, of self-representation and self-confidence vis-à-vis the social environment.

As the basic paradigm of the human ability to symbolise, language is the pivotal instrument for constructing social realities and the central medium of social interaction between human beings. A common language creates a central means of socialisation and, in an environment of different languages, provides a central element of self-definition in contrast to others. Using the language of an ethnic-linguistic or a socio-cultural group or status-group in itself implies self-attribution to that group. The survival of a language spoken by small groups reflects the power of their historical identity and their social background. Both are fixed in linguistic and, more generally, in symbolic traditions including specific semantic and ritual codes. The loss of a specific language always means the loss of a system of symbolic codes and values. These are fundamental to aspects of the mentality, cultural tradition and self-representation, all of which are expressed in the onomastic tradition.²⁹ Since the identity of ethnic groups is, to a large extent, based on a common language and a common language tradition, ethnic identity is expressed first of all in linguistic coding and semantic.

The long survival of the Celtic language among the Galatian tribes in confrontation with a culturally dominating, supra-regional language of communication which, in addition, was of the highest social status, as was the case with Greek, is a strong indication of the power of the tradition and the historical identity and self-definition of the Galatians. The automatic switch to Greek, when the means of communication changed from oral to written, is no counter-argument. Since the Early Bronze Age, regions with a specific regional culture and important supra-regional cultural influences had existed side by side in Asia Minor.³⁰ Language proved to be a central factor here for the persistence of collective identity and self-representation. The Luwian language and language tradition, for instance, continued well into the 5/6th century AD and constituted a fixed part of the Isaurian identity.³¹ The same is true for the Luwian dialects in Lycaonia and Cappadocia.³² Phrygian was a spoken language at least well into the 6th century AD.³³ Herodotus is an example of the opposite development: although he was born in the old West-Anatolian, but early Hellenised city of Halikarnassos in a family of Carian tradition, he considered himself both culturally and linguistically an Ionian Greek.

3 THE SETTLEMENT AND ETHNOGENESIS OF THE GALATIAN PEOPLES IN ASIA MINOR

In 278 BC, King Nikomedes of Bithynia had been fighting together with his allies in the so-called Northern League (first of all Byzantion, Pontic Herakleia, and the Mithradatic Kingdom of Pontus) against the Seleucid king Antiochos I. He had hired migrating groups of Celtic peoples who stayed in the south-eastern Balkans near Byzantion as mercenaries (*symmachoi*). In 275/74 BC, he handed over to them the eastern part of northern Phrygia (i.e. the Galatian territory west of the River Halys, today Kızıl Irmak), as

²⁹ For the importance of onomastic traditions as a reflection of a *Bewußtseinsgemeinschaft*, cf. Wenskus 1977, 59 ff.; Rübekeil 1992, 1996; T. Anderson, *RGA*² 22, 2003, 589–614, s.v. Personennamen, esp. 594 ff., 609 ff.; Geuenich/Haubrichs/Jarnut 1997; Haubrichs 1995, 2004.

³⁰ Cf. also Mitchell 2000.

³¹ Cf. Feld 2005, 42 f.; Burgess 1990.

³² For the continuity of pre-Hellenistic language traditions in general, cf. Holl 1908; Mitchell 1993 I, 172 ff.

³³ Cf. Sokr. 5,23 (PG 67, 648A); Holl 1908; Brixhe 1999.

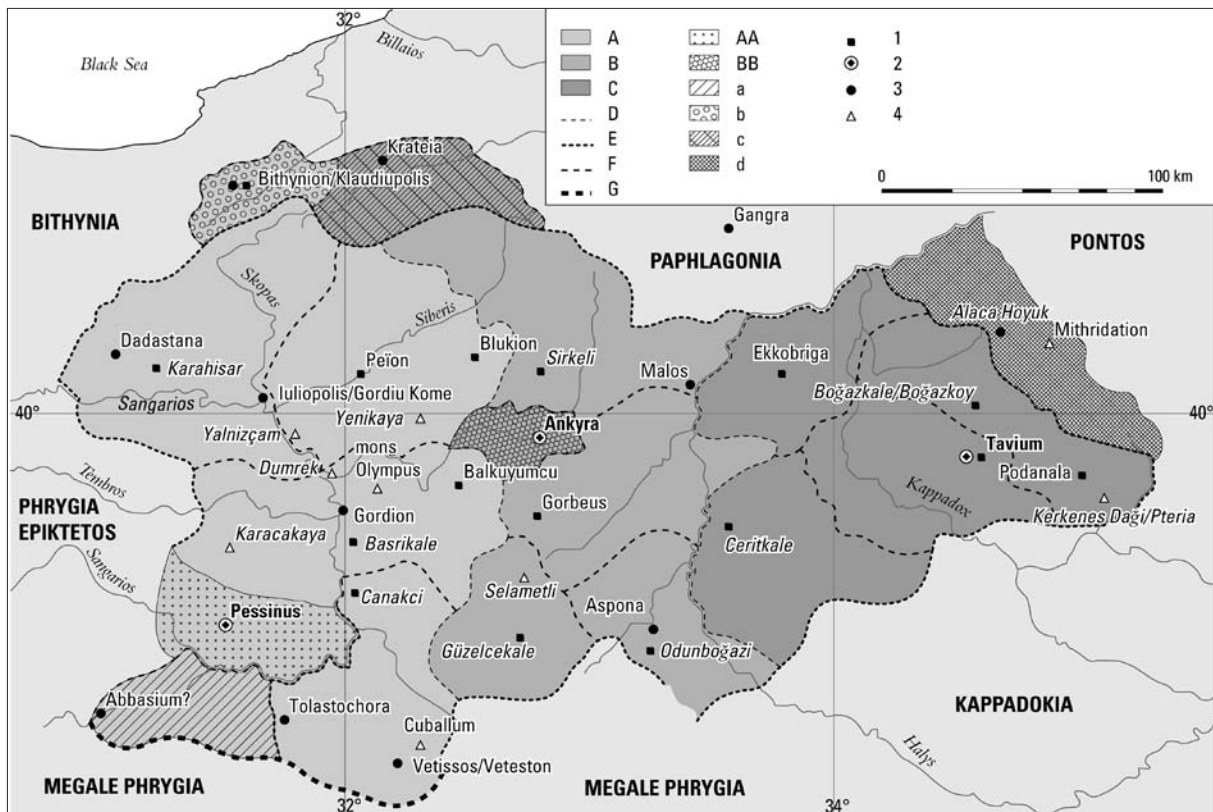

Fig. 1. Territories of the three tribal states of Galatians in Central Asia Minor from the early 3rd century until 25 BC. A Territory of the Tolistobogioi; B territory of the Tektosages; C territory of the Trokmoi; D boundary between the tribal territories; E boundary of Galatian territory (after 180/179 BC); F hypothetical boundary between the tetrarchies; G frontier zone with Megale Phrygia.

a territory lost to Pergamon (183 BC); b territory lost to Bithynia (179 BC); c territory lost to Paphlagonia (179 BC); d territory won by the Trokmoi.

AA Temple state of Pessinus; BB territory of the city of Ankyra.

1 Fortified residence (3rd – 1st century); 2 Roman *civitas* capital; 3 important settlement; 4 fort, ruins of former city

was agreed in the treaty he had concluded with the Celtic leaders. In return for their services as *symmachoi* for the kings of Pontus during their conflict with Herakleia over the town of Amasis – the Galatian forces had beaten off a seaborne invasion by a Ptolemaic fleet that assisted Herakleia – the Celts further received, most likely in 274/273 BC, the frontier area between Cappadocia on the Pontus (better known as Pontus) and Greater Cappadocia, which was within the Seleucid sphere of influence. The area given by the Mithradatides was situated in the bend of the river Halys and comprised the central fertile regions around the middle and lower reaches of the river Kappadox (today Delice Irmak) with the important regional centre of Tavium, the old Anatolian city of Tawinija.³⁴ The region that Nikomedes had handed over to the Celts included the area within the eastern bend of the River Sangarios, the region of the Koroğlu Dağları and the area south of these mountains as far as the Halys and the Great Salt Lake, i.e. the territories south of Paphlagonia (the kingdom of Gangra), and the now eastward-expanding Bithynian kingdom. In the north, the north-western limits of Paphlagonia (the basin of Krateia/Gerede, the ‘country of Gaizatorix’), and the area of the Free Mariandynians as far as the Abant Dağları, including the basin of Bolu, were part

³⁴ Cf. Strobel/Gerber 2000, 2003.

of the Galatian territories until 179 BC, when they fell to Paphlagonia and to Bithynia as a result of the defeat of Pharnaces, king of Pontos, and his Galatian allies.³⁵ After the defeat of the Galatians by Antiochus I in the so-called ‘battle of the elephants’, most likely in 268 BC, the border between the territory of the Galatians – who now became important *symmachoi* for the Seleucids in Asia Minor – and the Seleucid empire was definitely established (fig. 1).

The three tribes of the Tolistobogioi, Tektosages, and Trokmoi³⁶ divided up the given land among themselves. The most important group, the Tolistobogioi, occupied the large areas west and east of the Sangarios bend with the urban centre of Gordion, while the Tektosages held the central strip of land west of the Halys, but also including, beyond the river, the basin of Kırıkkale. The Trokmoi received the territory east of the Halys bend, i.e. eastern Galatia, comprising the old fertile region around the middle and lower Delice Irmak, the ancient Kappadox, and its tributaries. The region the Celtic immigrants took over included a large number of villages and other settlements³⁷ which existed alongside the major centres of Gordion, Ankyra and Tavium. The agricultural structures were prosperous and provided a great variety of agricultural products.³⁸ The traditional routes to and from the old economic centres of Gordion, Ankyra and Tavium, which continued to be improved in Persian times, helped to create a well-connected area in Central Anatolia, which came to be of great economic importance thanks to its resources, communication network and agricultural produce.

It is important to note that the three immigrant groups of Celts did not develop into a unified *gens*,³⁹ but rather cultivated the individual tribal identities of their leading, kin-based groups and of the sub-groups associated with them.⁴⁰ In terms of ethnic origin and historical identity, they all remained committed to their former self-definition. This fact proves that the core groups of the three tribal formations were fixed and stable identity-bearing and tradition-conveying bodies based on the leading aristocratic kin groups.⁴¹ After taking possession of the country and settling in it, a process called ‘*Territorialisierung*’ began, a complex process of ethnogenesis that transformed the migrating groups, tribal sections, clans or components of clans into new social units based on their territories. This process ultimately gave rise to the historical Galatian peoples known in the later 3rd and in the 2nd century BC. The ethnogenesis was based upon the integration of the autochthonous population into the politically and socially dominating Celtic groups.⁴² In this case, ethnogenesis does not refer to the primary shaping of an *ethnos*, but to a gradual process of re-shaping which tribes and peoples or parts of tribes and peoples go through

³⁵ Cf. Strobel 1994a. There are erroneous assumptions in Darbyshire/Mitchell 1999, 166, 181, 184, first, that the area of the Tektosages extended far more southwards including parts of Pisidia in the 1st c. BC, second, that the entire northern part of Galatia should belong to the Tolistobogians, and finally that fortifications in southern Paphlagonia should be attributed to the Galatians. Parnassos was a place in Cappadocia (Polyb. 24, 14, 8), and there were no Trokmian sites round Çorum nor north of Çorum (in contrast to Mitchell 1993 I, 54; not always convincing Darbyshire/Mitchell/Vardar 2000, 79). The Proseilemmene became part of the territory of Ankyra only in the new territorial organisation under Augustus (cf. Strobel, *DNP* 10, 2001, 437, s.v. Proseilemmenitai).

³⁶ The Tolistobogioi and Trokmoi had come as mercenaries to Asia Minor in 278, and were joined by the Tektosages in 277 BC.

³⁷ For the continuity of Anatolian place names, see *TIByz* 4, 1984; *RECAM* II, Index; Zgusta 1970, 1984; furthermore Neumann 1961; G. Neumann, *RIA* 10, 2005, 543–546.

³⁸ Cf. Strobel 1996, 79 ff., 94 ff.; *ibid.* on the geographical and ecological conditions; Darbyshire/Mitchell 1999, 188 ff.

³⁹ Cf. Gschnitzer, *Geschichtliche Grundbegriffe* 7, 1992, 168–171; H. Wolfram, *RGA*² 22, 2003, 174–178, s.v. Origo gentis.

⁴⁰ Cf. Plin., *NH* 5, 146; Strobel 2002b, 235 ff.

⁴¹ Cf. references cited above note 22, esp. Wenskus 1977, 59 ff., 64 ff.; H. Castritius, *RGA*² 29, 2005, 508–515, s.v. Stammesbildung, Ethnogenese.

⁴² Cf. R. Corradini, *RGA*² 17, 2001, 602–611, s.v. Landnahme (esp. 602–604, 607).

on migration and in subsequent territorialisation. In these complex processes, convergence is built on elite groups that bear high prestige, identity and tradition and establish themselves as the ruling power. The focus was on the historical identity of the leading prestigious core-groups and on its specific codes including language, self-image, and values.

In addition to the names of the three tribes, we know the names of several tribal subgroups, which in the Greek terminology were called tetrarchies or ‘fourths’, obviously following a principle of internal territorial and tribal subdivision of Celtic peoples. While we thus know the Voturi and Ambitouti as tribal subunits of the Tolistobogioi and the Toutobodiaci as a subunit of the Tektosages,⁴³ we are unable to assign the tetrarchy of the Tosiopai to one of the three main tribes.⁴⁴ Each tetrarchy had its own independent political structure and leadership under a ‘quarter-ruler’ or tetrarch.⁴⁵ Alongside the twelve tetrarchies as subdivisions of the three peoples of the Galatians, Pliny the Elder mentions 183 *populi* as additional subgroups; they can be seen as kin groups or clans, or to use the Old Irish term, as *fine*, and they were headed by noblemen or (clan) chieftains (Old Irish *agae fine* or *cenn fine*) and their families.⁴⁶ Essentially, the three main tribes of the Galatians were federations of tribal groups and clans which attributed the common historical and ethnic identity of the respective tribes to themselves. The *populi* or clans of the Galatians, organised in 12 tetrarchies, a loose political federation with a common representative assembly, only took on their ultimate historical shape during the territorialisation of the immigrating groups as part of process of ethnogenesis of the Galatian peoples in Central Anatolia. We can call the whole complex process the Galatisation of the core of Central Anatolia and its population by the small, but politically, socially and linguistically dominant, groups of Celtic immigrants. As Strabo testifies (12, 5, 1), the Celtic language was used all over the Galatian territories as a unifying and delimitating characteristic by the 1st century BC. It remained the mother tongue of broad population strata until the mid-6th century AD, as I have already said before, although in Hellenistic times Greek was already the second language of the Galatian elite and parts of the populace were bilingual (Celtic language and Anatolian dialects). In Hieronymus’ wording, the Galatians learnt a new language, but did not lose their own as a consequence of intermarriage; the Celtic language was used in Late Antiquity alongside the generally widespread Greek, even in Ankyra, the metropolis of the Roman province.⁴⁷ The long-lasting persistence of language⁴⁸ and ethnic

⁴³ Plin., *NH* 5, 146.

⁴⁴ Plut., *mor.* 259a–c. It is unclear whether the Rhigosages, *symmachoi* or mercenaries fighting in the army of Antiochus III against Molon (Polyb. 5, 53, 3), were a further subdivision of the Galatians in Asia Minor or whether they were mercenaries recruited directly from the Balkans like the Aigosages of Attalos I of Pergamon. However, the second option is more probable.

⁴⁵ For the federal structure which was destroyed in the First Mithridatic war, cf. Strab. 12, 5, 1; Strobel 2002a, 2002b, 240 ff. Cf., for example, Birkhan 1997, 141, 996 on ‘quarter-rulers’ as ‘kings of provinces’; Strobel 2002b, note 46; Kelly 1995; Birkhan 1997, 791. Coşkun 2004 tries to prove Strabon’s constitutional sketch to be wrong. However, none of his arguments are convincing. The title *tetrarches* was not introduced by Pompeius in 62 BC, but was a Greek synonym for a Celtic title. The title is attested prior to the time of Pompeius. Strabon’s sketch is a short version of the presumably much more detailed description in his lost *Historika Hypomnemata*.

⁴⁶ Plin., *NH* 5, 146 (195 *populi et tetrarchiae*); the 52 Galatian *duces* taken along on Manlius Vulso’s triumphal procession in 187 BC (Liv. 39, 7, 2) were probably recruited on the whole from captured clan chieftains. Cf., for example, Birkhan 1997, 994 ff.

⁴⁷ Cf. Strobel 1996, 139 ff.; cf. above, note 27.

⁴⁸ While Neo-Phrygian inscriptions are clearly missing in Galatian tribal territories to the west of the Halys (cf. Waelkens 1977), a transitional bilingual Phrygian-Galatian zone is discernible at the southern limits of Galatia; cf. the Greek inscription of *Bodoris* (or *Bodorix*) from Sinanlı with a Neo-Phrygian formulaic text from the area north of Veteston/Vetisso (MAMA VII 214) in the southern part of the Tolistobogioi, which did not belong to region of Proseilemmene (in contrast to Mitchell 1993 I, 50; contrary to him, Yaraşlı was not part of the Galatian tribal territories, but of the Proseilemmene) which was annexed to the territory of the city of Ankyra in Roman times.



Fig. 2. Hellenistic tumulus at Gordion (c. 100 BC). The chamber is now rebuilt in the Gordion Museum (author's photograph).

identity can be seen as a crucial factor in the processes of ethnogenesis and acculturation of the Galatian peoples of Asia Minor in the 3rd and 2nd century BC.

The original population of the later Galatian areas, the autochthonous people of the Phrygian or Luwian (and Palaian in the North) language traditions, lived in numerous villages and was undoubtedly several times larger than the groups of Celts arriving here to settle in their new land. When they crossed into Asia Minor, they totalled a maximum of perhaps 25,000 to 30,000 or probably even less, but armed warriors made up a disproportionately large number.⁴⁹ It must be assumed that there was a strong demographic imbalance amongst the immigrating Celtic groups; we see the characteristically high proportion of armed men in other cases of migrating groups. Furthermore it must be assumed that they suffered considerable losses in fighting up to 268 BC, and an unknown number of warriors may have joined Hellenistic armies as mercenaries. These factors had to be compensated for, particularly by recourse to the local population. In the course of the territorialisation of the immigrating tribal groups, sub-groups, and warrior bands, whose inner structure was based on the military following of their chiefs, women undoubtedly joined them in considerable numbers to be integrated into the clans in various forms of marriage and with varying legal status.⁵⁰ The specific internal structure of the clans, based on the strict hierarchy of Celtic tribal society and its legal system, and their readiness to accept foreign persons were instrumental in absorbing the much greater numbers of the indigenous population into the different

⁴⁹ Liv. 38, 16, 2,9; cf. Strobel 1996, 237, 246.

⁵⁰ Cf. Strobel 2002b, 245 ff.; Birkhan 1997, 1029 ff.

tribal groups and clans and their historical and ethnic traditions. This process of integration also provided many possibilities for social advancement. Celtic peoples appear to be typical of that specific type of society, well-known in anthropology, which shows a remarkable ability to absorb a foreign population in large numbers into their social and ritual structures in the course of only one or two generations.

After the settlement in central Anatolia, which was not challenged after 268 BC, superimposition on and integration of the indigenous population in a process of ethnogenesis and mutual acculturation gave rise to the historical Galatian peoples in Asia Minor. The whole process was finished in less than three generations. The higher stratum of the Celtic immigrants formed the governing class and left their mark on language, socio-political order, and historical and ethnic identity. While the tumuli of the leading elite show Hellenistic standards (fig. 2), the Luwian or Phrygian-Anatolian population predominantly influenced everyday life, from housing and building styles or methods of storage to kitchenware and the Hellenistic-Anatolian types of graves. The networks of trade and commerce, local and regional manufacturing traditions, and the patterns of land use apparently continued.

The Celts did not challenge the existing village communities, but integrated them into their own social hierarchy and system of social rule. Little or no change occurred in the life of the local village populations during Galatian times, even if their legal status might have declined, insofar as they were not already part of a dependent population. We do not know what the social structures of the area in Persian times were, but we may reasonably assume aristocratic landownership, royal estates, and temple territories.⁵¹ The lower social strata of the Celtic and Anatolian populations quickly developed into a relatively homogeneous amalgam with shared religious beliefs and practices, with shared identities and value systems and a shared language. The names show Phrygian, Old Anatolian, Hellenistic Greek and Celtic traditions at the same time (we will examine these phenomena in one of the following paragraphs). The continuity of rural life is characteristic of Galatia in Roman times. It is only in the 4th century AD that Christianisation and the institutions of the Church changed important aspects of life. While Christian belief led to a totally new onomastic habit, according to the *vita* of Theodoros of Sykeon, everyday life in the villages was still much the same in the 6th century AD.⁵²

At the same time, we must emphasise that the Galatian upper classes, whose wealth was based on the control of agriculture, were the important forces in the process of Hellenisation in Central Anatolia. The Galatisation of this part of Anatolia led to a more intensified Hellenisation of the area, which reached the lower strata of society outside the cities to some extent only in the 2nd or 3rd century AD. The acculturation of upper class Galatians to contemporary Hellenistic culture in terms of their representative self-portrayals and lifestyle is well documented in the extravagant architecture of their graves (cf. fig. 2) and fortresses since the 2nd century BC and in the imported fine ware and luxury goods since the 3rd century BC.⁵³ In the 2nd century BC, the fortified residences of the princely elite were built in contemporary and sophisticated Hellenistic-Anatolian architecture.⁵⁴ Gordion, the former Phrygian capital, was rebuilt as an Early Hellenistic regional centre at the beginning of the 3rd century BC and then became the central settlement of the Tolistobogioi, until it was destroyed by Cn. Manlius Vulso in 189 BC. Galatian Gordion provides the best evidence for the above-mentioned phenomena of Hellenisation

⁵¹ Cf. Debord 1999.

⁵² Cf. Festugière 1970; Mitchell 1993 II, 122 ff.

⁵³ Cf. Strobel 2002a, 2002b.

⁵⁴ Darbyshire/Mitchell/Vardar 2000, 88-93 wrongly associate sites in Paphlagonia and fortifications – which can clearly be dated into Byzantine times – with the Galatians. A list containing a great number of small fortifica-

tions which were built with only a minimum of stonework erected in dry-stone building technique or rubble walling was compiled in the surveys of L. Vardar and his team since 1996, but they must be dated into middle and late Byzantine times. Contrary to Darbyshire/Mitchell/Vardar *l.c.*, there is no evidence for a Hellenistic/Galatian context.

in the 3rd century BC.⁵⁵ Hellenistic style buildings, a public area with a large representative buildings, and workshops of Greek artists are characteristics of the Galatian city. Greek graffiti from Galatian levels – all writing was done in Greek – show a mixed population of Greek, Phrygian–Anatolian and Celtic inhabitants. Some houses of the early Galatian period produce new tools used for specific food processing habits as evidence of the immigrants in the 3rd century BC; the wide-spread presence of horse bones is a new phenomenon too. Both indicate some Celtic influence in everyday life.

4 THE CITIES OF ROMAN GALATIA – ANKYRA, PESSINUS, TAVIUM – AND THE CONTINUITY OF HISTORICAL IDENTITY

The important old Anatolian and later Phrygian town of Ankyra dominated a small but fertile and well-watered basin.⁵⁶ In Phrygian and Hellenistic times, the town's urban area of Ankyra extended far beyond the citadel and upper town to the western slopes of the citadel's rock and included the centre of the later Roman town and the high terrace of Ulus.⁵⁷ Ankyra remained independent from the Tektosages until Pompey's reorganisation in 65/64 BC,⁵⁸ but we can suppose with good reason that there were always close relations with the neighbouring tetrarchies of the Tektosages and Galatian aristocrats and ordinary people were already living in the city previous to 65/64 BC. When Augustus, after the death of Amyntas, the king of Pisidia and last tetrarch of all Galatians, annexed the kingdom and established the new Roman province of Galatia (comprising the whole former kingdom) in 25/24 BC, Ankyra was organised as an autonomous Greek city (*polis*), received the status of metropolis of the province, and became the main centre of the *koinon* of the Galatians (*koinon* of the *Sebastenoi Galatai*).⁵⁹ The territory of the new autonomous city of Ankyra now comprised the *civitas* of the Tektosages. Large parts of the original Tolistobogian territory were added insofar as that had not been incorporated into the territory of the new autonomous city of Pessinus, the new Tolistobogian capital and upholder of Tolistobogian *ethnos*.

Neither Ankyra's affiliation with the territory of the Galatian rulers after 65/64 BC nor its merging with the *ethnos* of the Tektosages after 25/24 BC left traces on the town's internal organisation. Inscriptions refer to a figure of twelve phylae which are well documented in the honorary inscription for Latinia Cleopatra, erected in the time of Hadrian by all twelve phylae.⁶⁰ The original names of the phylae of the autonomous *polis* can be traced back to Phrygian and Luwian traditions only.⁶¹ They are derived from regions or people: *Marouragene* (no. 1), *Pakalene* (no. 2), *Hiermene* (no. 4), [-]mene (no. 7), from a group of population, which itself derived from the god Men: phyle of the *Menorizeites* (no. 3);

⁵⁵ Cf. Strobel 2002b, 261 ff.; also Henrickson/Blackman 1999; archaeological summaries in Voigt 2003; Kealhofer 2005. Liv. 38, 18, 10–13 calls Gordion an *oppidum*, a fortified town, Polyb. 37, 8 a *polismaton*, a well built city.

⁵⁶ Alexander visited Ankyra in 333 BC (Arrian., *an.* 2, 4, 1; Curtius Rufus 3, 1, 22). Livius (38, 24, 1), who followed his source Polybios, referred to Ankyra as an urban settlement: *nobilem in illis locis urbem*.

⁵⁷ Important new discoveries in Ankara have come to light during the excavations on the Ulus and provide new evidence for the Early and Middle Iron Ages and for Hellenistic and Early Roman Imperial periods; cf. the

summaries in Strobel 2002b, 242; Uçankuş 2002, 261 ff.; a brief history of Ankara in Cross/Leiser 2000; on ancient Ankyra, French 2003, 26 ff.; Bennett 2003.

⁵⁸ Strab. 12, 5, 2 called Ankyra a 'fortress' or 'fortified settlement' of the Tektosages, not, however, a *polis*.

⁵⁹ For the urbanisation of Galatia and the organisation of autonomous cities and its territories during the reign of Augustus, cf. also Mitchell 1993 I, 80 ff., esp. 86 ff.; 198 ff.

⁶⁰ Bosch 1967, no. 117.

⁶¹ Cf. Bosch 1955; 1967, 141 ff.; Mitchell 1977, 77 ff.

thirdly from a deity: phyle of Zeus Taenos⁶² (no. 12); and from a place of worship: phyle of *Dios Trapezōn* (no. 5, altars of Zeus); one phyle is named in honour of the urban government: *Hiera Boulaia* (no. 9); and another one in honour of Augustus: *Sebasteia* (no. 6). Later, new names for existing phylae appeared which replaced older, unknown names⁶³: *Claudia Athenaiia* (no. 8), *Nerva* (no. 10), *Nea Olympia* (no. 11; referring to Hadrian). Although the last mentioned phylae possibly were just additions to an original number of only nine, there is much to be said against this since the phyle of Zeus Taenos certainly held the 12th place. The number of twelve phylae must have been fixed in early Augustan times when the population of the newly founded autonomous *polis* was organised in the traditional manner of a Greek city state, governed by the council (*boule*) and the people (*demos*) of the city. We can rightly assume that Ankyra was already established as an urban settlement as early as the Early Hellenistic Age – several citizens of Ankyra together with their families can be traced in Athens since the late 4th century BC.⁶⁴ – but this settlement was not organised according to the model of the Greek *polis*. There is no evidence for the existence of polis-institutions in pre-Roman times. We do not know the inner political structure of the Phrygian city of Ankyra or of any preellenistic Phrygian city, but we can assume with good reason that the city was governed by local aristocrats. Perhaps the civil administration of the Late Hellenistic city was led by an *archon*.⁶⁵ The Phrygian-Anatolian elite and the members of the leading Galatian aristocracy of the third quarter of the 1st century BC became incorporated into the upper social strata of the new autonomous city and provincial metropolis. They filled the positions of the city government.⁶⁶ The *collegium veteranorum* comprised a Roman element in the city, already established in the early period of the new province when a legionary garrison stayed there.⁶⁷ In contrast to the common practice of erecting funerary inscriptions in Greek, Roman veterans have their tombstones inscribed in Latin.

On Severan coins minted by the *Metropolis Ankyra*, Ankyra also appears as the city of the *Sebastenoi Tektosages* or, shorter, of the *Sebastenoi*.⁶⁸ Other coins minted in the 1st century AD in the name of the *Sebastenoi Tektosages* did not explicitly mention the name of the town. In the same way, an honorary inscription of the first half of the 2nd century was erected by the council and the people of the *Sebastenoi Tektosages*, i.e. of Ankyra.⁶⁹ These documents show the long lasting identification of the urban community of Ankyra with the historical and ethnic tradition of the Tektosages. Although Ankyra was the metropolis of the Koinon of the Galatians, the tradition of three independent *ethne* was preserved within the Koinon until at least the early 3rd century AD.

The building of the temple of the imperial cult in Ankyra, dedicated to Dea Roma and Augustus, must have started soon after the province and the Galatian Koinon were established. The construction of huge substructures, which were to provide the platform of the temenos, certainly took some time. While parts of the temple's cella were under construction by the mid-Augustan period, the sanctuary was finally dedicated in AD 19/20 as we can reasonably assume on the basis of the list of high priests (*archieis*) of the cult. This list, given by the inscription on the south anta of the temple, documents the *archieis* during the reign of Tiberius together with the gifts, donations, festivals and games provided by them.⁷⁰ The lemmata of this

⁶² A special epiclesis of Zeus; it cannot be identified with Zeus Taouianos/Tavianus or derived from the Old Anatolian stem of the name *Taw-*, (several variations: *Tawinija*, *Taouia*, *Taouion*, *Tavium*, *Tavia*, *Tabia*, ethnic name *Taouioi*) as erroneously assumed by Kruse, *RE* IV A 2, 1932, 2007, s.v. Taenos; Bosch 1967, 275; French 2003, 108. Cf. Bosch 1967, no. 211, a dedication to *Zeus Megistos Taenos* (not *Tavianos* as in French 2003, 65); but Bosch 1967, no. 212 is a dedication to *Zeus Tavianos*.

⁶³ This explanation is not discussed by Bosch 1967, 141 ff.

⁶⁴ Cf. Bosch 1967, no. 12–46 and commentary.

⁶⁵ Also attested in Roman times; cf. French 2003, no. 11.

⁶⁶ Cf. also Mitchell 1993 I, 89, 199 ff.; Cross/Leiser 2000, 70 ff.; French 2003, 55 ff.

⁶⁷ French 2003, no. 46. Cf. Strobel 2002d.

⁶⁸ For the numismatic evidence, cf. *RPC* I 3546–3567; II 1614–1617; *ISEGRIM*, s.v. Ancyra; Arslan 1991, 1997; for the denomination on the coins, Bosch 1967, *passim*.

⁶⁹ Bosch 1967, no. 92.



Fig. 3. General view of Tavium. A Büyükkale; B Küçükkale; C so-called 'Hangstadt' up to the northern ridge; D Zeğrektepe with the tehatre and the eastern part of the city (author's photograph).

inscription mention the three *ethne*, the three Galatian peoples which were shown as separate 'nationalities' within the Koinon of the Galatians, i.e. the people in Pessinus, now the Tolistobogioi, the people in Ankyra, now the Tektosages, and the people in Tavium, now the Trokmoi. The ethnos of Tavium, the Trokmoi, was not always included among the recipients of the high priests' gifts listed in the inscription, and whereas several high priests only donated gifts to the ethnos in Ankyra, one of the priests donated special gifts and spectacles only to the people of Pessinus. Both Pessinus and Tavium had their own temples, priests, and celebrations of the cult of Dea Roma and Augustus. Although Ankyra was the metropolis of the Koinon of the Galatians and the main centre of the imperial cult, all three Galatian peoples preserved their identity and self-reliance within the organisation of the Koinon well into the 3rd century AD.

The new autonomous city of Pessinus, founded in 25/24 BC, is attested under the name *Galatai Tolistobogioi Pessinountioi* or *Sebastenoi Tolistobogioi Pessinountioi* on coins and inscriptions.⁷¹ The temple state of Pessinus⁷² had remained independent in Hellenistic times. Between 189/188 and 168 BC, its territory was very probably extended, at the expense of the Tolistobogioi, as far as the River Tembris and the River Sangarios. At that time the Sangarios was flowing along the eastern side of the old urban area of Gordion.

⁷⁰ Bosch 1967, no. 51; cf. Mitchell 1993 I, 107 ff.; for the dating of the temple, Mitchell 1993 I, 102 ff. and note 28; Rumscheid 1994, 6 f.

⁷¹ Cf. *ISEGRIM*, s.v. Pessinus; Strubbe 2005 for the inscriptions and testimonia. *Sebastenoi Tolistobogioi* (IK Pessinus 170); *Sebastenoi Tolistobogioi Pessinountioi* (IK Pessinus 13; 15; 16); 1st–2nd century AD.

⁷² Cf. K. Strobel, *DNP* 9, 2000, 658–660, s.v. Pessinus;

Strobel in press. The widespread assumption that calling the priests of Kybele 'Galloi' goes back to the Celts of Asia Minor is ill-conceived (cf. Waser/Ruge/Cumont, *RE* VII/1, 1912, 674–682, s.v. Gallos on the Phrygian tradition of the name *Gallos*). The symbol of the cock on the gravestones of the priests is often brought into connection with the name *Galloi*, but has a completely different symbolic background.

The position of the independent temple state of the priests of Kybele, who first looked for support from the Seleucids and then from Rome and Pergamon, must have been strengthened by the fact that the cult of the Great Mother, or *Matar (kybileia)*, gained greatest importance among the neighbouring Tolistobogioi who interpreted the goddess with their own concept of female gods.⁷³ We have good reason to believe that members of leading Tolistobogian aristocratic families became priests at Pessinus as early as the 3rd century. Between 163 and 156 BC, the temple state was headed by a Galatian prince, known under his traditional cultic name of Attis, and a brother of Aioirix, tetrarch of the Tolistobogioi.⁷⁴ The fact that the priests of Pessinus welcomed Manlius Vulso in 189 BC is no counter argument against the above mentioned assumption, as it would be wrong to assume a pan-Galatian consciousness or even a 'national' loyalty amongst the Celts. Being high priest in Pessinus, Attis only felt obliged to his temple state and its interests and to his own power. For the first time between 65/64 and 59/58, and then definitely from 56 BC, Pessinus was under control of Deiotaros I, sole tetrarch of the Tolistobogioi, who now held the power of investiture of the high priests. After the annexation of Amyntas' kingdom into the new Roman province of Galatia, Pessinus too became an autonomous *polis*. The temple of the imperial cult and the theatre associated with it were erected in the reign of Tiberius. Probably already under Augustus, but under the emperor Claudius at the latest, the imperial authority ordered a reform of the priesthood of the temple of Kybele. There were now one high priest and ten other priests, half of them of Phrygian, the other half of Galatian descent. Typical examples are Tiberius Claudius Heras and his son Tiberius Claudius Deiotarus in the later 1st century AD,⁷⁵ who were 9th and 10th on the overall list of priests in Pessinus, and 4th and 5th on that of the priests of Galatian lineage.

The main settlement in the area of the middle Kappadox was Tavium (Tawinija in Old Anatolian sources of the 2nd millennium BC). In Hellenistic times, the sanctuary of Zeus Tavianos, the Greek name for the Hittite god Teššop, was of supra-regional importance and possessed the internationally recognised right of asylum.⁷⁶ The god's colossal bronze statue was praised by Strabo.⁷⁷ The fortified Hellenistic urban settlement (ca. 175 ha), which was already an important centre in the Early Bronze Age, did not have the status of an autonomous polis in pre-Roman times and therefore appears in Strabo's description only as an emporium and stronghold (*phrourion*) of the Trokmoi.⁷⁸ Since 274/72 BC, Tavium was their main settlement and most probably the residence of the most important tetrarchy of the Trokmoi (fig. 3):⁷⁹ beyond doubt, the last Trokman tetrarch Brogitaros Philorhomaioi, son of an unknown Deiotaros, and

⁷³ Cf. Roller 1991; Strobel 2002a, 2002b; also Birkhan 1997, 513 ff. on the Celtic notion of the great, nameless mother goddess, the great godly power manifested in nature, who, at the same time, was the deity of the country and appeared in a series of images of female gods.

⁷⁴ Welles 1934, no. 55–61 = IK Pessinus 1–7.

⁷⁵ IGRR III 225.230 = OGIS 540.541 = IK Pessinus 17.18. Strubbe 2005, 31 ff. tries to date the careers to the late 2nd century AD, but his arguments are not convincing. For Heras and Deiotarus, see also below, note 118.

⁷⁶ Cf. K. Strobel, *DNP* 12/1, 2002, 61, *s.v.* Tavium; Strobel/Gerber 2000, 2003, 2006, 2007, 2008; Strobel 2008. For the coins of Tavium, cf. *BMC Galatia*, p. XXIII; Imhoof-Blumer p. 497; *RPC* I 3568–3570; II 1624–1626; *SNG France* 3, 2642–2646; *ISEGRIM*, *s.v.* Tavium; American

Numismatic Society (www.numismatics.org), *s.v.* Tavium; also www.coinarchives.com, *s.v.* Tavium.

⁷⁷ Strab. 12, 5, 2. In Roman times the coins of the town portrayed the statue modelled on that of Zeus in Olympia and the hexastyle temple (cf. *BMC Galatia* no. 3.4.6.17 and pl. V 12; *RPC* I, p. 548; II p. 235).

⁷⁸ Strab. 12, 5, 2.

⁷⁹ The Hellenistic fortress was built on the southern rocky promontory of Büyükkale in the southern part of the city of Tavium.

his wife Adobogiona, had their residence in Tavium⁸⁰ until the couple was murdered by Brogitaros' rival and father-in-law Deiotaros I in about 52 BC. During the organisation of the Roman province of Galatia in 25/24 BC, Tavium did not become an autonomous city at once, but a little later in 21/20 BC.⁸¹ The whole territory of the Trokmoi was now organized as the *polis* of the *Sebastenoi Trokmoi Taouianoï* or *Trokmoi Taouianoï*. In the years 226–250 AD, the city's self-designation was *Sebaste Trokmôn Taouia*.⁸²

5 THE POPULATION OF ROMAN GALATIA: SHARED TRADITIONS, VALUES, AND RELIGIOUS THOUGHTS

Most ancient place names recorded for the Galatian territories are of Anatolian tradition⁸³ and illustrate the strong continuity of settlement and population during the 1st millennium BC, which is now also apparent from numerous archaeological surveys. The same continuity can also be seen in pre-Galatian names of regions and smaller areas like Lagantine, Mnezine, Kalmizene, and Konkarzitiakōton. In the mid-3rd century BC, the settling of Celtic immigrants in existing villages was apparently completed; newly founded settlements with a Celtic place name are rare, the most important example of which is Ekkobriga.⁸⁴ Other Celtic toponyms are: Petrobrogen (also Ipetrobrogen), a stop on the main road from Nikaia to Ankyra;⁸⁵ the toponym Souliobrogen or Souliobriga, which is related to the epithet of Zeus Souolibrogenos⁸⁶; Rosolodiaco⁸⁷; Acitoriciacum⁸⁸; Erigobrogis⁸⁹; Tolastochora,⁹⁰ which may be derived from a short form of the ethnic name of the Tolistobogioi; Ueteston (*chora Ouëtisseōn*);⁹¹ Vindia or Uindia.⁹² In Vindia was a shrine of the Anatolian moon god Men, worshipped as Theos Ouindiei-

⁸⁰ Both had close relations with several cities (*IGRR* IV 1683, Pergamon; *OGIS* 349 = IK Kyme 15; *I. Didyma* 475, 35–40 Brogitaros and his sister Adobogiona). Brogitaros bought the rule over Pessinus and the royal title from Clodius in 58 BC. For his silver coinage, cf. *BMC Galatia*, p. XVII. Brogitaros' sister Adobogiona (*OGIS* 348, honoured by the people of Methymna) was the mother of Mithradates of Pergamon whose father was Mithradates VI Eupator King of Pontos. Later she married Menodotos, a wealthy citizen of Pergamon. Her son became a decisive ally of Caesar in the *bellum Alexandrinum* and received the Trokman tetrarchy – which Caesar took away from Deiotaros I – and the royal title of the Bosphoranic Kingdom in 47 BC, but died shortly after on his campaign to conquer the Bosphoranic Kingdom.

⁸¹ Cf. Leschhorn 1993, 410–414, who, however, wrongly supposes that the Trokmoi were not at once incorporated into the new province in 25/24 BC. Cf. also Drew-Bear/Labarre 2002, 78 f.

⁸² Drew-Bear/Labarre 2002, 71, no. 2. The dedication of the Homonaia-statue in Antiochia in Pisidia must be related to the time of the separation of the city from the province of Galatia during these years.

⁸³ See above note 37. Assumptions of Celtic origin for toponyms are exaggerated in Mitchell 1993 I, 50 and

note 89. For Celtic place names, cf. also P. de Bernardo Stempel, *RGA*² 16, 2000, 407–413.

⁸⁴ Cf. Strobel, *DNP* 12/2, 2002, 950; idem 2007c.

⁸⁵ *TIByz* 4, 215.

⁸⁶ *RECAM* II 191; from the area around Kızılhamam.

⁸⁷ *TIByz* 4, 219.

⁸⁸ Tab. Peut. 9, 5.

⁸⁹ Festugière 1970, I, 24 f.

⁹⁰ *TIByz* 4, 236.

⁹¹ *TIByz* 4, 242.

⁹² Ptol. 5, 4, 5; as a road stop in *Itin. Ant.* 201, 5; 202, 9; *TIByz* 4, 171. Mitchell 1993 I, 50, 55 erroneously interprets the name Vindia as the Celtic name of Gordion, which would have lost its former name in the 2nd century BC. However, Gordion appears as a village in Strab. 12, 5, 3; this village is the settlement of Later Hellenistic times and was rebuilt as a planned settlement in Roman times and continued into Late Antiquity. The tell of the upper-town of Gordion was resettled after a hiatus following the destruction in the year 189 BC. Vindia, in contrast, was the Celtic name for the settlement on the eastern bank of the ancient riverbed of the Sangarios, which was directly located at the river crossing of the road from Pessinus to Ankyra. For Roman Gordion, cf. Goldman 2005.

nos.⁹³ Another toponym is Chōrion Artikniakon,⁹⁴ which is derived from the Galatian personal name Artiknos. We know an Artiknos who belonged to one of the Tolistobogian aristocratic families and also appears in the list of priests at the temple of Roma and Augustus in Ankyra.

Strong evidence for shared traditions and values is the common use of Celtic personal names. This phenomenon can be followed well into the 4th century AD, when Christianity completely changed onomastic customs in Asia Minor.⁹⁵ We can recognise a social amalgam that was shaped by the processes of ethnogenesis and acculturation. Variable use of and switching between different onomastic traditions of Celtic, Anatolian, Greek and Latin names is typical of the social milieu.⁹⁶ For instance, in Ankyra in the 2nd century AD, Diogneta, daughter of Tektomarus, erected a gravestone for her husband Statilius, son of Gaius.⁹⁷ The tombstone of Claudius Statilius and Claudius Deiotarianus probably dated to the later 2nd century AD was erected by their sister Claudia Briseis.⁹⁸ Klodia, daughter of Bitognatos, erected a memorial for her husband, Valerios, and her son, Poupoulos, a corrupt form of Publius.⁹⁹ From Kalecik (ancient Malos) we know a tombstone that Katomaros erected in 165 AD in memory of his wife Octaviane and his daughter Domne; father and daughter both have Celtic names.¹⁰⁰ A good example of the mixed use of different onomastic traditions is the 1st /2nd century AD altar found near Ankara: it was dedicated by Tatas, an Anatolian name, and Bellon, a Celtic one.¹⁰¹

The specific form of Romanisation which affected Asia Minor was primarily a phenomenon of the cities and in Galatia especially of Ankyra, the metropolis of the province and true nodal point in the communication lines of the Roman East. Characteristic of the social upper class in 1st-century AD Ankyra is the switch to the onomastic tradition of Roman citizens. In the dedication of the year 102 AD to Trajan,¹⁰² 60 men have Roman personal names, 17 have names of Roman citizens (though several with Greek cognomina), and ca. 120 have names of Greek origin, whereas only one name is of Persian, and one of Celtic origin: Marcellus, son of Boiorix. In the 2nd-century AD honorific inscription for Kyrikkos (Celtic), son of Manes (Phrygian), a certain Titianus (Latin), son of Bougionos (Celtic), appears as an important member of the 11th phyle of Nea Olympias at Ankyra.¹⁰³ In both cases, the father still had a Celtic name.

Another specific aspect of social and ethnic identity can be analysed in the religious habit. A particularly striking example of the continuity of the local population and, at the same time, of the intentional spiritual standardisation is given by the inscriptions found in and around the sanctuary of Zeus Bussurigiōs, 'Zeus with the royal mouth', north-west of modern Kalecik, the ancient village of Malos in the district of Kalmizene.¹⁰⁴ Malos was situated on the western riverbank of the Halys where the road from Ankyra

⁹³ Votive inscription near Konya (Buckler/Calder/Cox, *JRS* 14, 1924, 24–84, no. 1) set up by a citizen of Hadrianopolis, southwest Paphlagonia (*TIByz* 9, 1996, 155 f.).

⁹⁴ *RECAM* II 172.

⁹⁵ Cf. *RECAM* II, Index; *SEG* 32, 1982, 1663; Stähelin 1907, 109 ff.; Weißgerber 1931; Bosch 1952/53; Schmidt 1957, 1994, 1995; Dressler 1967; Zgusta 1964, 1970; Evans 1967; Strubbe 1978; Masson 1982; 1986; Strubbe 2005, XII f. and note 16 (several interpretations are not convincing). Several studies also include Celtic names in Asia Minor belonging to persons of Celtic origin but not belonging to the Galatian peoples.

⁹⁶ Cf. for the change between Greek and Latin names, *RECAM* II 204; IK Pessinous 163: Argeios, son of Tertius, and his wife Bella and the children Klodia, Brikkon, Tertius, and Lupus.

⁹⁷ Bosch 1967, no. 147.

⁹⁸ Bosch 1967, no. 57.

⁹⁹ *RECAM* II 214.

¹⁰⁰ *RECAM* II 209.

¹⁰¹ French 2003, no. 34.

¹⁰² Bosch 1967, no. 98.

¹⁰³ French 2003, no. 19.

¹⁰⁴ *RECAM* II 201–206. For this invocation of Zeus, cf. H. Schwabl, *RE X A*, 1972, 253 ff., esp. 291 ff., also 288, 293, 339, 358, s.v. Zeus I, Epiklesen; Birkhan 1997, 147, 662, who wants to interpret this god as the god of law, i.e. corresponding to the Celtic god Lugus. Birkhan erroneously interprets Zeus Bennios as another Celtic invocation which, however, was a Phrygian one. For the cult of Zeus in Galatia, cf. also Schwabl, *RE Suppl.* 15, 1978, 1159 ff., 1474, s.v. Zeus II Kultbelege. The cults of Zeus Narenos and Zeus Sarnendenos, which were also present in north-western Galatia, originated from northern Phrygia.

to Ekkobriga and to Tavium coming down from the Baykuşbeli pass crossed the river.¹⁰⁵ The sanctuary itself was located near the modern village of Karahüyük where an ancient settlement can be traced back into prehistoric periods. Inscribed boundary stones of the 6th century AD belonging to a shrine for the Archangel Michael presumably marked the Christian successor of the cult of Zeus Bussurigos;¹⁰⁶ they mention the name of the village Diakimelion in the district of Konkarzitiaköton, a district separated from the Kalmizene by the above mentioned pass. The inscriptions belonging to the cult of the sanctuary are significant: Aurelius Sentamus, who had a Celtic name and came from the village of Dallapoze, erected two monuments in 218 AD. On the first monument, he appears as a worshipper of Zeus Bussurigos, on the second, which he erected together with his mother Akka and his grandson Sentamus, as the *archigallos*, the local high priest of the great goddess Kybele, who was apparently worshipped here alongside Zeus Bussurigos.¹⁰⁷ Aurelius Helius, son of Domnus, whose father had a Celtic name, came from the village of the Klössamenoi; he was *neokoros* of Zeus Bussurigos and erected a votive monument dedicated to the god during his lifetime, which at the same time served as his memorial.¹⁰⁸ Aurelius Philotas, son of Stateilios (Statilius), from the village of Ikotarion, was a worshipper and servant of Zeus Bussurigos; he erected his funeral stele during his lifetime in 227 AD.¹⁰⁹ No direct mention of the god can be found on the memorial of Aurelius Askepiades, son of Asklepius, from the village of Malos in the district of Kalmizene, which was erected in 251 AD.¹¹⁰

Additional Galatian invocations of Zeus, who united the aspects of the god of heaven, weather and mountains, and who represented a Hellenised Celtic interpretation of the older Anatolian cults, especially of Teššop, were Zeus Souölibrogenos¹¹¹ and Zeus Bussumaros ('large mouth', in German '*Großmund*') whose cult is also attested in Apulum in Roman Dacia.¹¹² Roman legionaries of Galatian origin took the cult of Zeus Bussumaros to Dacia. Contrary to H. Birkhan, in my opinion such invocations should not be understood as attributes of the god; the epithets Bussurigos and Bussumaros are rather derived from the names of sub-groups of the Galatian population, i.e. from the Boussourigioi and the Boussoumaroi. The cult of Zeus Tavianos has already been mentioned above. It is very probable that the Celtic immigrants identified the goddess Artemis, the Hellenised form of the Old Anatolian goddess Kubaba and especially of her Minervan aspect, with their own concept of the Great Goddess. The Galatian princess Kamma, who killed the tetrarch Sinorix, the father of Deiotaros I and murderer of her husband, was a hereditary priestess of Artemis; Plutarch tells us that this goddess was most venerated by the Galatians.¹¹³ The phenomenon of the tetrarchic aristocracy adopting Anatolian cults and religious concepts is also the background of Augustus' appointment of Dyteutos, son of Adiatorix, as high priest and ruler of the temple state of the goddess Ma in Pontic Comana, where his short lived predecessor Kleon failed because he violated the taboo against pork. We can assume Dyteutos was connected with this Anatolian cult at least in some way.¹¹⁴

¹⁰⁵ *TIByz* 4, 1984, 201 f. The settlement goes back at least to Hittite times. There was a Jewish *proseuche* in the 3rd century AD (*RECAM* II 209b) and a Montanist church (Mitchell 1982).

¹⁰⁶ *RECAM* II 207–208.

¹⁰⁷ *RECAM* II 201, 206.

¹⁰⁸ *RECAM* II 203.

¹⁰⁹ *RECAM* II 204.

¹¹⁰ *RECAM* II 205. *RECAM* II 209a presumably belongs to this series too (dated to 217 AD).

¹¹¹ *RECAM* II 191 (157 AD); epithet derived from a toponym.

¹¹² Cf. *CIL* III 1033; 1421515 (as an invocation of *Iupiter Optimus Maximus*). Zeus Tavianos was also brought from Galatia to Apulum by Roman soldiers or military colonists.

¹¹³ Plut., *mor.* 257e–258c; 786c. The sacred procession during the great spring festival of Kybele in 312 AD is mentioned in the life of Saint Theodotos of Ankyra (cf. Mitchell 1982, esp. 105 ff.) where the name of the goddess is given as Artemis too.

¹¹⁴ Cf. Strab. 12, 3, 35; 12, 8, 9.

6 THE GALATIAN ARISTOCRACY: HISTORICAL IDENTITY AND THE ‘IMPACT OF EMPIRE’

After the formation of the province of Galatia, the aristocratic elite of the Galatians was integrated into the new political structures of both the three *poleis* and the Galatian Koinon; they were thus incorporated into Roman provincial rule and became important supporters of the new bonds of loyalty.¹¹⁵ As Galatarchs, Helladarchs,¹¹⁶ and priests or high priests of the imperial cult (*hierous, archiereus, Sebastophantes, neokoros*), they held leading positions in the Koinon – for the Koinon as a whole at the temple of Roma and Augustus in Ankyra or for the local imperial cults at Pessinus and Tavium. The Koinon’s Tiberian list of high priests, inscribed on the wall of the south anta of the temple of Roma and Augustus at Ankyra, presents the contemporary top echelon of the Galatian aristocracy:¹¹⁷ Pylaimenes, son of King Amyntas, who was not allowed to follow his father on the throne in 25 BC; Kastor, son of King Brigatos; Albiorix, son of Ateporix; Amyntas, son of Gaizatodastes; Musanos, son of Artiknos; Aristokles, son of Albiorix.

Typical examples of how close these institutions were interwoven are the careers of Ti. Claudius Heras and his son Ti. Claudius Deiotarus.¹¹⁸ As representatives of the Galatian lineage, both held the office of priest for life in the sanctuary of Kybele at Pessinus in the late 1st century AD. Furthermore, Heras, the father, was priest of Kybele in the city of Midaion as well. In addition, he was six times *archiereus* of the Koinon at Ankyra and *sebastophant* of the temple of the imperial cult at Pessinus, where he was also the presiding priest. He had been prefect of a Cohors Ituraeorum and equestrian tribune of the legions XII Fulminata and III Cyrenaica, and had received military decorations in the Judean war of Vespasian and Titus. Deiotarus, his son, was twice *archiereus* of the Koinon and also *sebastophant* of the temple of the imperial cult at Pessinus.

During the reigns of Augustus, Tiberius, and Claudius, Roman citizenship was granted to the leading families of Galatian society. From the Flavian period onwards, they were integrated into the senate and the leading social strata of the Roman Empire. However, they remained proud of their Galatian descent, and in their monuments kept emphasising this identity and the prestige associated with it. Ti. Claudius Gentianus, for example, is praised on his funerary monument for his erudition and his ancestry that is traced back to an unknown Asklepios as well as to Galatian tetrarchs.¹¹⁹ His father was Ti. Claudius Sacerdos, a close relative of Ti. Claudius Sacerdos Iulianus, *consul suffectus* in 100 AD and *magister* of the Fratres Arvales in 101 AD. Another example is Latinia Cleopatra, daughter of Latinus Alexander, a leading citizen of Ankyra, who was honoured by the phylarchs of all 12 phylae of Ankyra in Hadrianic time.¹²⁰ She is praised as a descendant of kings, i.e. of the Attalids and the last Galatian rulers. In an honorific inscription from the time of Antoninus Pius, Ti. Claudius Bocchus is praised as the son of the Galatarch Ti. Claudius Alexander, and as a descendant of Galatian tetrarchs.¹²¹ On the other hand, in the honorific inscription of his son Ti. Claudius Procillianus, such a reference to descent is missing.¹²² It seems that the direct ancestry that was integrated into the leading class of Asia Minor and the Empire gained pre-eminence in the second half of the 2nd century AD. Claudia Balbina, ‘first

¹¹⁵ Cf. Mitchell 1993 I, 100 ff.

¹¹⁶ President and former president of the Council of the Koinon. Cf. French 2003, 44.

¹¹⁷ See above note 68. Q. Gallius Pulcher, *archiereus* of the Koinon in 35/36 AD, had his home in Pessinus and in the Tolistobogian ethnos; his family had received the Roman citizenship from Q. Gallius, quaestor of Cilicia ca. 47/46 BC; the *cognomen* is related to Clodius (cf. Mitchell 1993 I, 35).

¹¹⁸ See above note 75.

¹¹⁹ Bosch 1967, no. 73; cf. Halfmann 1979, 49, 116.

¹²⁰ Bosch 1967, no. 117 = French 2003, no. 18. One of the dedicating phylarchs was a certain Aquila, son of Dekmos; the father has a Celtic name. Bosch 1967, 147 proposed the correction into the Latin *praenomen* Decimus, but that must be rejected.

¹²¹ Bosch 1967, no. 100; French 2003, no. 11.

¹²² Bosch 1967, no. 142; French 2003, no. 12.



Fig. 4. The funerary monument of Bellon, discovered at Susuz-Böcü Mevkii (Tavium-no. ÇC 01).

The text reads: Βέλλων Γουτουμάρου / ἥρωος χρηστῆ χαιρε. / Γριμίταλος καὶ Ανδρόμαχος τὸν ἐα(υ)τῶν πατέρα / ἀρετῆς ἔνεκεν.

'Bellon, son of Goutoumaros, good hero, greetings. Grimitalos and Andromachos (honoured) their father for his virtue.'

(lady) of the province' and 'mother of the metropolis (Ankyra)', possessed the rank of a queen according to her royal descent and was praised for her unparalleled munificence.¹²³ She was *sebastophant* of the imperial cult at Ankyra, and married to (L.) Claudius Arrianus, *consul suffectus* in the mid-2nd century AD.¹²⁴ All families mentioned above demonstrated their identity by reference to the historical identity and high prestige of the tetrarchic aristocracy and their position within the aristocratic social elite of the eastern part of the Empire.

Even more spectacular is the example of C. Iulius Severus.¹²⁵ He was the most prominent citizen of Ankyra during the reigns of Trajan, Hadrian, and Antoninus Pius; he was *consul suffectus* in 138 (or 139) AD, governor of Germania Inferior, member of the *pontifices* in Rome, *proconsul* of the province of Asia in 152/153 AD, and 'relative of many Roman senators'. Severus was *archiereus* of the Koinon and *sebastophant*. During the winter 113/114 AD, he provided food for Trajan's army in its winter quarters at Ankyra at his own expense, a clear indication of his enormous wealth. His later honorific inscriptions emphasise his descent from kings and tetrarchs,¹²⁶ but his earlier inscriptions are more precise:¹²⁷ he was a descendant of the king (and finally tetrarch of all Galatians) Deiotaros I and of the tetrarchs Amyntas, son of Brigatos, and Amyntas, son of Dyitalos. The last mentioned Amyntas, son of Dyitalos, was probably the grandfather of the famous King Amyntas, son of Dyitalos, king of Pisidia and the last tetrarch of all Galatians. Although Severus was a descendant both of the royal family of the Attalids and of three dynastic lines of the tetrarchic aristocracy, his descent from Attalos, King of Asia, i.e. Attalos II of Pergamon, is praised only after his tetrarchic ancestry. The first wife of Deiotaros I was Stratonike, probably the great-

¹²³ Bosch 1967, no. 75. Cf. *PIR*² C 1080.

¹²⁴ Halfmann 1979, 173-174 no. 92.

¹²⁵ Halfmann 1979, 47-49, 151-152 no. 62; *PIR*² I 573. Iulius Severus was the son of Iulius Quadratus (*PIR*² I 505) and was a near relative of C. Antius A. Iulius Quadratus from Pergamon, *consul suffectus* 94 AD and *consul II ordinarius* 105 AD, one of the important friends of Trajan (*PIR*² I 507; Halfmann 1979, 112-115, no. 17). C. Antius A. Iulius Quadratus and his close relative C. Iulius Quadratus Bassus (Halfmann 1979, 119 f., no. 26), one of the most important generals of Trajan, were of royal Pergamenian descent. A further link to Iulius Severus is

A. Iulius Amyntas (Halfmann 1979, 114), a relative of C. Antius A. Iulius Quadratus. These connections illustrate the network of marriage and descent between the leading families of Pergamon and Galatia. Several more family relations of Iulius Severus can be pointed out (C. Claudius Severus, C. Iulius Alexander, Ti. Iulius Aquila Polemaeanus).

¹²⁶ *ILS* 8826 = Bosch 1967, no. 156; Bosch 1967, no. 157; French 2003, no. 14.

¹²⁷ *OGIS* 544 = Bosch 1967, no. 105; Bosch 1967, no. 106. Cf. Aristeides, *or.* 50, p. 428, 443-444 (ed. Keil).

granddaughter of Attalos II. Severus' brother was C. Iulius Amyntianus¹²⁸ whose name demonstrates the tetrarchic descent. Severus had married Claudia Aquillia, also praised as a descendant of kings.¹²⁹ His son was C. Iulius Severus, *consul ordinarius* in 155 AD and one of the leading generals in the Parthian war of Lucius Verus;¹³⁰ Elagabal married his granddaughter, the Vestal Virgin Iulia Aquilia Severa.

Since the 3rd century BC, a profound process of Hellenisation had already affected major aspects of the lifestyle of the Galatian 'upper class', including eating and drinking habits. This is shown through imported and locally produced fine ware, imported wine, through the production of Hellenistic terracotta figurines, imported luxury goods, jewellery, and specific aspects of religious cults, especially the *interpretatio Graeca* of deities. Hellenistic culture became a dominant point of reference during the 2nd century BC. Deiotaros I, whose honorific statue was erected in Athens and who had close relations to Ephesos or Nikaia, was well known for his erudition in Greek poetry and literature.¹³¹ However, the ethnic self-identification and historical identity was only based on the Galatian tradition. The image-conscious use of the own ethnic-historical tradition and the corresponding ethnic-historical self-representation provided the basis for the Galatian aristocracy to separate its own group from the other groups of the same social status in Asia Minor and to preserve the specific military and 'barbaric' prestige that had been known by the people of Asia Minor and the Eastern Mediterranean since 281 BC.¹³² The bust of Adobogiona, the daughter of Deiotaros I and wife of Brogitaros, belonging to her honorific statue in Pergamon,¹³³ which must be dated between 63 and 58 BC, shows an individual and consciously non-Greek portrait in contrast to the Greek costume and headdress. This evidence is even more important because the Late-Hellenistic royal portrait expresses ideological content. Thus the identity of the group, the awareness of the 'we' in contrast to 'the others', was preserved into Roman times.

This self-consciousness did not prevent the leading aristocracy of the Galatian clans and tetrarchies from alternating between different onomastic traditions in the 2nd and 1st centuries BC, corresponding with their acculturation in Asia Minor and their Hellenistic environment.¹³⁴ One part of the names in the last ruling generations of the tetrarchic families and in the following generation in Roman times is Celtic: Deiotaros, Domnekleios (or Domnilaos),¹³⁵ Dyitalos, Dyteutos, Brogitoros, Brigatos Adiatorix, Ateporix, Albiorix, Artiknos, Gaizatodiastes, Zmertorix,¹³⁶ and Adobogiona (three women bearing the same name). A second part is of Macedonian (royal prestige) and Greek origin: Amyntas, Seleukos, Kastor, Aristokles, Diognetos, Menemachos, Metrodoros. A third small group is of Anatolian origin: Kamma, Pylaimenes (the traditional dynastic name in Paphlagonia). The phenomenon of the repeated alternation between different onomastic traditions from one generation to the next and also within the same generation is well attested

¹²⁸ *PIR*² I 147; cf. Halfmann 1979, 152. Contrary to the doubts of D. French, he put up the dedication *SEG* 27, 852 = French 2003, no. 28.

¹²⁹ Bosch 1967, no. 107-108.

¹³⁰ Cf. Halfmann 1979, 165-166, no. 81.

¹³¹ *IG* II² 3429; Cic., *Deiot.* 25; Varro, *rust.* 1, 1, 10.

¹³² Cf. Strobel 1994b; idem 2002b, 280 f.

¹³³ Cf. Strobel 1991, 130 and note 194. Her daughter, the younger Adobogiona, was the wife of the younger Kastor, tetrarch of all Galatians 41/40-37/36 BC, and the mother of Deiotaros Philadelphos, the last king of Paphlagonia.

¹³⁴ Cf. Pylaimenes, son of King Amyntas; King Amyntas, son of Dyitalos, son of Amyntas, son of Dyitalos; Aristokles,

son of Albiorix; Amyntas, son of Gaizatodiastes; Amyntas, son of Brigatos; Musanos, son of Artiknos; Zmertorix, son of Philonides. Galatian mercenary leaders in Seleucid armies had Greek or Attic-Ionic names already in the late 3rd century (cf. Lysimachos; Polyb. 5, 79, 11) or preserved their Celtic name (Apatourios; Polyb. 4, 48, 8f.).

¹³⁵ Two different forms of the name in Caes., *BC* 3, 4, 5 and Strab. 12, 3, 6.

¹³⁶ Marcus Antonius gave Zmertorix, son of Philonides, the city of Eumeneia in Phrygia where he minted coins (Imhoof-Blumer 231; *BMC Phrygia* 21; Lindgren/Kovacs 1985, 160 and pl. 120). His son Valerius Zmertorix was the leading magistrate of the city in the early Tiberian period (*RPC* I, 3144).

in the funerary monument of Bellon, son of Goutoumaros, which was erected by his sons Andromachos and Grimaltos (fig. 4).¹³⁷ The stele, which was found by the author in 2004, is an import made of Parian marble and was erected in the cemetery which belongs to a big estate in the area west of Tavium. The inscription was made by a local stonecutter and most probably dates to the late 1st century BC. The estate, which belonged to an aristocratic Galatian family, was specialised in the large scale production of wine and continued to exist well into Late Antiquity. The stele had been repaired after damage and the rear side of it had been worked for incorporation into a greater monument, a clear sign of the long-lasting veneration of the ancestors. A very well made funerary inscription was found in Haydarbeyli near Tavium. It belonged to a great circular monument built by Athenais and her husband Deiotaros for her father Amyntas, son of Satton.¹³⁸ Here again we glimpse a family of the Trokman aristocracy of the first half of the 1st century AD.

7 EPILOGUE

The historical identity and ethnic tradition of the Galatian peoples, which had not just been defined by themselves, but had been attributed to them by others as well, remained alive and stable after the tribal states and their autonomous political organisation had come to an end in 25/24 BC. The basic processes were the settlement and the process of ethnogenesis and acculturation in Central Anatolia in the 3rd century BC; this ‘Galatisation’ of the central area of inner Asia Minor created the three historical Galatian peoples as a Celtic-Anatolian population, but whose elite was shaped by an early and growing Hellenisation. The Galatians continued to be a specific and well-defined group within the large Roman province of Galatia. The most salient feature, which makes them unique and distinctive within Hellenistic and Roman Asia Minor, was their common use of the Celtic language until well into Late Antiquity. We would like to emphasise here that after the mid-2nd century BC no other cultural feature of the social elite or of the broader population would have made them distinct from the surrounding people in Central Anatolia. The second characteristic element is the continuity of the ethnic names and self-definitions of the Galatian peoples, which remained alive well into the 3rd century AD and became dominant for the new urban and administrative organisation of the Galatian territories under Roman rule after 25/24 BC. The continuity of the historical identity is attested on several levels of social life: onomastic and religious traditions or the self-definition of the social elite and the cities. Telling is that the literary tradition¹³⁹ even ascribes the founding of the well-known city of Ankyra to the Galatians of Asia Minor. However, not only the founding of Ankyra but also that of the cities of Pessinus and Tavium was ascribed to them, and even the names of Pessinus, the old and well-known Phrygian temple-state, and of Tavium, would have been taken from legendary leaders of the Galatians. At the back of such theories was the strong identification of the cities with the ethnic-historical identity of the Galatian peoples in Roman times and the remarkable vitality of the historical identity and ethnic tradition of the three Galatian people as they took shape in Central Anatolia after 272/268 BC. Ankyra was the metropolis of the Koinon of the Galatians, which was established by the Roman authority when the much larger province of Galatia was organised; but even within the Koinon the tradition of the three independent Galatian peoples was preserved. Since at the same time the external attribution of the people of the three cities to the ethnic collective for the Galatians continued, the identity of the ethnic-historical group of the Galatians, i.e. the common consciousness of

¹³⁷ Cf. Strobel 2006; Strobel/Gerber 2007, 596 f. The stele is now in the village of Çamdibi (Tavium-no. ÇC 01). Measures: 56,5 x 136,5 x 17 cm.

¹³⁸ Tavium-Projekt, Fund-Nr. Ha 6 (2002) = *RECAM* II 498

¹³⁹ Cf. Memnon of Herakleia and Apollonius of Aphrodisias (*FGH* 434 F 11, 7; 740 F 14); Steph. Byz., s.v. Ankyra, Pessinus; cf. Strobel 1996, 254 ff.

ethnic identity, the symbol of affiliation, and the ethnic-historical self-confidence could be preserved during Roman times. This phenomenon was the precondition for the survival of the native Celtic language and had at same time its own mental foundation in the living Celtic language tradition.

ABBREVIATIONS

<i>BCH</i>	<i>Bulletin de Correspondance Hellénique</i>
<i>BMC</i>	<i>British Museum Coins</i>
<i>CRAI</i>	<i>Comptes rendus des séances de l'Académie des inscriptions et belles-lettres</i>
<i>DNP</i>	<i>Der Neue Pauly</i>
<i>EtCelt</i>	<i>Études Celtiques</i>
<i>FGH</i>	Jacoby, F., 1923- : <i>Fragmente der griechischen Historiker</i> , Berlin.
<i>I Didyma</i>	Rehm, A. (ed.), 1958: <i>Die Inschriften von Didyma</i> , Berlin 1958
<i>IGRR</i>	<i>Graecae ad res Romanas pertinentes</i>
<i>IK</i>	<i>Inschriften griechischer Städte aus Kleinasien</i>
Imhoof-Blumer	Imhoof-Blumer 1901
<i>ISEGRIM</i>	<i>Informationssystem zur Erfassung Griechischer Münzen: Datenbank kleinasiatischer Münzen</i> (http://hist-3-10.philfac.uni.duesseldorf.de/isegrim/index.html)
<i>JHS</i>	<i>Journal of Hellenic Studies</i>
<i>MAMA</i>	<i>Monumenta Asiae Minoris Antiqua</i>
<i>OGIS</i>	<i>Orientis Graecae Inscriptiones Selectae</i>
<i>PIR</i>	<i>Prosopographia Imperii Romani</i>
<i>RECAM II</i>	Mitchell, S., 1982: <i>Regional Epigraphic Catalogues of Asia Minor II. The Inscriptions of North Galatia</i> , Oxford
<i>RGA²</i>	<i>Reallexikon der Germanischen Altertumskunde</i> , 2 nd edition
<i>RIA</i>	<i>Reallexikon der Assyriologie</i>
<i>RPC</i>	<i>Roman Provincial Coinage</i>
<i>SEG</i>	<i>Supplementum Epigraphicum Graecum</i>
<i>SNG</i>	<i>Sylloge Nummorum Graecorum</i>
<i>TIByz</i>	<i>Tabula Imperii Byzantini</i>

REFERENCES

- Anderson, J.G.C., 1910: A Celtic cult and two sites in Roman Galatia, *JHS* 30, 163-167.
- Arslan, M(elih), 1991: The coinage of Ancyra in the Roman period, in C.S. Lightfoot (ed.), *Recent Turkish coin hoards and numismatic studies*, Oxford, 3-42.
- Arslan, M(elih), 1997: The Roman coinage of Ancyra in Galatia, in J. Nollé (ed.), *Internationales Kolloquium zur kaiserzeitlichen Münzprägung in Kleinasien*, Milano, 111-156.
- Arslan, M(urat), 2000: *Antikçağ Anadolu'su'nun savaşı Kavmi Galatlar*, Istanbul.
- Assmann, A. (ed.), 1998: *Medien des Gedächtnisses*, Stuttgart.
- Assmann, A. (ed.), 1999²: *Identitäten*, Frankfurt.
- Assmann, A., 2003²: *Erinnerungsräume. Formen und Wandlungen des kulturellen Gedächtnisses*, München.
- Assmann, A. (ed.), 2004: *Positionen der Kulturanthropologie*, Frankfurt.
- Assmann, A./Friese, H. (eds), 1998: *Identitäten. Erinnerung, Geschichte, Identität*, Frankfurt.
- Assmann, J., 2000³: *Das kulturelle Gedächtnis. Schrift, Erinnerung und politische Identität in frühen Hochkulturen*, München.

- Barth, F. (ed.), 1969: *Ethnic groups and boundaries*, London.
- Bennett, J., 2003: Ancyra, metropolis provinciae Galatiae, in P.R. Wilson (ed.), *The archaeology of Roman towns. Studies in honour of John S. Wacher*, Oxford, 1-15.
- Birkhan, H., 1997²: *Kelten. Versuch einer Gesamtdarstellung ihrer Kultur*, Wien.
- Bosch, C., 1952/53: Die Kelten in Ankara, *Jahrbuch für kleinasiatische Forschungen* 2, 283-293.
- Bosch, E., 1955: Ankara. Die Phylen, *Jahrbuch für kleinasiatische Forschungen* 3, 57-74.
- Bosch, E., 1967: *Quellen zur Geschichte der Stadt Ankara im Altertum*, Ankara.
- Brather, S., 2000: Ethnische Identitäten als Konstrukte der frühgeschichtlichen Archäologie, *Germania* 78, 139-177.
- Brather, S., 2002: Ethnic identities as constructions of archaeology. The case of the Alamanni, in A. Gillet (ed.), 141-167.
- Brather, S., 2004: *Ethnische Interpretationen in der frühgeschichtlichen Archäologie. Geschichte, Grundlagen und Alternativen*, Berlin/New York.
- Brixhe, C., 1993: Du paléo- au néophrygien, *CRAI*, 323-344.
- Brixhe, C., 1999: Prolegomènes au corpus neo-phrygien, *Bulletin de la Société de linguistique de Paris* 94, 285-315.
- Brunner, K./G. Merta (eds), 1994: *Ethnogenese und Überlieferung*, Wien/München.
- Burgess, W.D., 1990: Isaurian names and the ethnic identity of the Isaurians, *Ancient Society* 21, 109-121.
- Cassirer, E., 1985: *Symbol, Technik, Sprache. Aufsätze aus den Jahren 1927-1933*, Hamburg.
- Cassirer, E., 1996: *Versuch über den Menschen. Einführung in eine Philosophie der Kultur*, Hamburg (transl. by R. Kaiser of E. Cassirer, 1944: *An essay on man*, New Haven).
- Cassirer, E., 2001: *Philosophie der symbolischen Formen I. Die Sprache*, Hamburg.
- Cassirer, E., 2002: *Philosophie der symbolischen Formen II. Das mythische Denken*, Hamburg.
- Cassirer, E., 2003: *Philosophie der symbolischen Formen III. Phänomenologie der Erkenntnis*, Hamburg.
- Cau, N., 2003: Nuovi antroponomi indigeni nelle iscrizioni greche della Licia di età ellenistico-romana, in B. Virgillio (ed.), *Studi ellenistici* 15, Pisa, 297-340.
- Coşkun, A., 2004: Die tetrarchische Verfassung der Galater und die Neuordnung des Ostens durch Pompeius, in H. Heftner/K. Tomaschitz (eds), *AD FONTES! Festschrift für G. Dobesch*, Wien, 687-703.
- Cross T.M./G. Leiser, 2000: *A brief history of Ankara*, Vacaville, CA.
- Dandoy, J.R./P. Selinsky/M.M. Voigt, 2002: Celtic sacrifice. Grim deposits of butchered bones attest ritual slaughter by Galatians at Gordion, *Archaeology* 55/1, 44-49.
- Darbyshire G./S. Mitchell, 1999: The Galatian settlement in Asia Minor, *Anadolu Medeniyetleri Müzesi 1998 Yılı*, 163-198.
- Darbyshire G./S. Mitchell/L. Vardar, 2000: The Galatian settlement in Asia Minor, *Anatolian studies* 50, 75-97.
- Debord, P., 1999: *L'Asie Mineure en IV^e siècle (412-323 a. C.). Pouvoirs et jeux politiques*, Paris.
- Dressler, W., 1967: Galatisches, in W. Meid (ed.), *Beiträge zur Indogermanistik und Keltologie. Julius Pokorny zum 80. Geburtstag gewidmet*, Innsbruck, 147-154.
- Drew-Bear, T./G. Labarre, 2002: Les trois statues de la concorde à Antioche de Pisidie, *Epigraphica anatolica* 34, 2002, 71-92.
- Eichler, E. et al. (ed.), 1995/1996: *Namenforschung. Ein internationales Handbuch zur Onomastik I-II*, Berlin/New York.
- Eriksen, T.H., 2002² (1993): *Ethnicity and nationalism. Anthropological perspectives*, London.
- Evans, D.E., 1967: *Gaulish personal names*, Oxford.
- Feld, K., 2005: *Barbarische Bürger. Die Isaurier und das Römische Reich*, Berlin/New York.
- Ferrary, J.-L., 2000: Les inscriptions du sanctuaire de Claros en l'honneur des Romains, *BCH* 124, 331-376.

- Festugière, A.J. (ed.), 1970: *Vie de Théodore de Sykéôn (2 vols): I Texte grec ; II Traduction, commentaire et appendice*, Bruxelles (Subsidia Hagiographica 48).
- Fischer, H. (ed.), 1992³: *Ethnologie. Einführung und Überblick*, Berlin.
- Frank, M., 2002: *Selbstwertgefühl. Eine historisch-theoretische Erkundung*, Frankfurt am Main.
- Freeman, Ph., 2001: *The Galatian language. A comprehensive survey of the language of ancient Celts in Greco-Roman Asia Minor*, Lewiston, N.Y./Queenstown, Ontario.
- French D., 2003: *Roman, Late Roman and Byzantine inscriptions of Ankara. A selection*, Ankara.
- Geary, P., 1983: Ethnic identity as a situational construct in the Early Middle Ages, *Mitteilungen der anthropologischen Gesellschaft Wien* 113, 15–26.
- Geuenich, D./W. Haubrichs/J. Jarnut (eds), 1997: *Nomen et gens. Zur historischen Aussagekraft frühmittelalterlicher Personennamen*, Berlin/New York.
- Gillet, A. (ed.), 2002: *On barbarian identity. Critical approaches to ethnicity in the Early Middle Ages*, Turnhout.
- Glazer, N./D.R. Moynihan, 1975: Introduction, in iidem (eds), *Ethnicity. Theory and experience*, Cambridge Mass, 1–26.
- Goldman, A., 2005: Reconstructing the Roman-period Town at Gordion, in L. Kealhofer (ed.), *The archaeology of Midas and the Phrygians. Recent work at Gordion*, Philadelphia, 56–67.
- Halfmann, H., 1979: *Die Senatoren aus dem östlichen Teil des Imperium Romanum bis zum Ende des 2. Jh. n. Chr.*, Göttingen.
- Hall, J.M., 2002: *Hellenicity. Between ethnicity and culture*, Chicago.
- Hamlin, C./J.M. Krois (eds), 2004: *Symbolic forms and cultural studies. Ernst Cassirer's theory of culture*, New Haven/London.
- Haubrichs, W., 1995: Namendeutung im europäischen Mittelalter, in E. Eichler *et al.* (eds), vol. I, 351–359.
- Haubrichs, W., 2004: Identität und Name. Akkulturationsvorgänge in Namen und die Traditionsgesellschaften des frühen Mittelalters, in W. Pohl (ed.), *Die Suche nach den Ursprüngen. Von der Bedeutung des frühen Mittelalters*, Wien, 85–105.
- Hauck, K., 1955: Lebensnormen und Kultmythen in germanischen Stammes- und Herrschergenealogien, *Saeculum* 6, 186–223.
- Heckmann, F., 1992: *Ethnische Minderheiten, Volk und Nation. Soziologie inter-ethnischer Beziehungen*, Stuttgart.
- Heinz, M., 1993: *Ethnizität und ethnische Identität. Eine Begriffsgeschichte*, Bonn.
- Henrickson, R.C./M.J. Blackman, 1999: Hellenistic production of terracotta roof tiles among the ceramic industries at Gordion, *Oxford Journal of Archaeology* 18, 307–326.
- Hock, H.H. (ed.), 1997: *Historical, Indo-European, and lexicographical studies. Festschrift L. Zgusta*, Berlin/New York.
- Holl, K., 1908: Das Fortleben der Volkssprachen in Kleinasien in nachchristlicher Zeit, *Hermes* 43, 240–254.
- Imhoof-Blumer, F., 1901: *Kleinasiatische Münzen*, Wien (reprint 1991).
- Kamber, P. H./R. Moser (eds), 1984: *Diachronica. Zum Verhältnis von Ethnologie, Geschichte und Geschichtswissenschaft*, Bern (Ethnologica helvetica 8).
- Kealhofer, L. (ed.), 2005: *The archaeology of Midas and the Phrygians. Recent work at Gordion*, Philadelphia.
- Kelly, F., 1995²: *A guide to Early Irish law*, Dublin.
- Leschhorn, W., 1993: *Antike Ären*, Stuttgart.
- Lindgren, H.C.L./E.L. Kovacs, 1985: *Ancient bronze coins of Asia Minor and the Levant from the Lindgren collection I*, San Mateo.
- Malkin, I. (ed.), 2001: *Ancient perceptions of Greek ethnicity*, Cambridge Mass.
- Margreiter, R., 1997: *Erfahrung und Mystik. Grenzen der Symbolisierung*, Berlin.

- Masson, O., 1982: Quelques noms celtes en Grèce et en Asie Mineure, *EtCelt* 17, 1982, 129-135.
- Masson, O., 1986: Thraces et Celtes en Asie Mineure, *Epigraphica anatolica* 7, 1-4.
- McInerney, J., 2001: Ethnos and ethnicity in Early Greece, in Malkin 2001, 51-73.
- Melville, G. (ed.), 2001: *Institutionalität und Symbolisierung. Verstetigung kultureller Ordnungsmuster in Vergangenheit und Gegenwart*, Köln/Weimar/Wien.
- Mitchell, S., 1977: Inscriptions of Ancyra, *Anatolian studies* 27, 63-103.
- Mitchell, S., 1982: The life of Saint Theodotus of Ancyra, *Anatolian studies* 32, 93-113.
- Mitchell, S., 1993 I/II: *Anatolia. Land, men, and gods in Asia Minor I-II*, Oxford.
- Mitchell, S., 1994: Termessos, king Amyntas and the war with the Sandaliôtai – A new inscription from Pisidia, in D. French (ed.), *Studies in the history and topography of Lycia and Pisidia. In memoriam A.S. Hall*, London, 95-105.
- Mitchell, S., 2000: Ethnicity, Acculturation and empire in Roman and Late Roman Asia Minor, in S. Mitchell/G. Greatrex (eds), *Ethnicity and culture in Late Antiquity*, London, 117-151.
- Mitchell, S./G. Greatrex, 2000: Introduction, in S. Mitchell/G. Greatrex (eds), *Ethnicity and culture in Late Antiquity*, London, xi-xvii.
- Mühlmann, W.E., 1964: *Rassen, Ethnien, Kulturen. Moderne Ethnologie*, Neuwied.
- Mühlmann, W.E., 1985: Ethnologie und Ethnogenese, in *Studien zur Ethnogenese*, Opladen (Abhandlungen der Rheinisch-Westfälischen Akademie der Wissenschaften 72), 9-27.
- Neumann, G., 1961: *Untersuchungen zum Weiterleben hethitischen und luwischen Sprachgutes in hellenistischer und römischer Zeit*, Wiesbaden.
- Orth, E.W., 2004²: *Von der Erkenntnistheorie zur Kulturphilosophie. Studien zu Ernst Cassirers Philosophie der symbolischen Formen*, Würzburg.
- Pohl, W., 1994: Tradition, Ethnogenese und literarische Gestaltung. Eine Zwischenbilanz, in K. Brunner/G. Merta (eds), 9-26.
- Pohl, W., 1998a: Strategies of distinction, in W. Pohl/H. Reimitz (eds), 1-15.
- Pohl, W., 1998b: Telling the difference. Signs of ethnic identity, in W. Pohl/H. Reimitz (eds), 17-69.
- Pohl, W., 2002: Ethnicity, theory, and tradition. A response, in A. Gillet (ed.), 221-239.
- Pohl, W., 2004a: *Die Germanen*, München (2nd ed.).
- Pohl, W., 2004b: Die Namen der Barbaren. Fremdbezeichnung und Identität in Spätantike und Frühmittelalter, in H. Friesinger (ed.), *Zentrum und Peripherie – Gesellschaftliche Phänomene der Frühzeit*, Wien, 95-104.
- Pohl W./H. Reimitz (eds), 1998: *Strategies of distinction. The construction of ethnic communities, 300-800*, Leiden/Boston/Köln (Transformation of the Roman world 2).
- Posner, R., 2004: Basic task of cultural semiotics, in G. Withalm (ed.), *Macht der Zeichen, Zeichen der Macht. Festschrift Jeff Bernard*, Wien, 56-89.
- Posner, R./K. Robering/T.A. Sobeok (eds), 1997-2004: *Semiotik. Ein Handbuch zu den zeichentheoretischen Grundlagen von Natur und Kultur I-IV*, Berlin.
- Roller, L.E., 1991: The Great Mother at Gordion. The Hellenisation of an Anatolian cult, *JHS* 111, 28-143.
- Roymans, N., 2004: *Ethnic identity and imperial power*, Amsterdam (Amsterdam Archaeological Studies 10).
- Rübekeil, L., 1992: *Suebica. Völkernamen und Ethnos*, Innsbruck.
- Rübekeil, L., 1996: Völkernamen Europas, in E. Eichler et al. (eds), vol. II, 1330-1342.
- Rumscheid, E., 1994: *Untersuchungen zur kleinasiatischen Bauornamentik des Hellenismus*, Mainz.
- Sachs-Hombach, K./K. Rehkämper (eds), 2004²: *Bild-Bildwahrnehmung-Bildverarbeitung*, Wiesbaden.
- Schmidt, K.H., 1957: Komposition in gallischen Personennamen, *Zeitschrift für celtische Philologie* 26, 33-301.
- Schmidt, K.H., 1958: Gallisch *nemeton* und Verwandtes, *Münchener Studien zur Sprachwissenschaft* 12, 49-60.

- Schmidt, K.H., 1994: Galatische Sprachreste, in E. Schwertheim (ed.), 15–28.
- Schmidt, K.H., 1995: Keltische Namen, in E. Eichler *et al.* (eds), vol., 762–774.
- Schwemmer, W., 2000: *Kulturphilosophie. Eine medientheoretische Grundlegung*, München.
- Schwertheim, E. (ed.), 1994: *Forschungen in Galatien*, Bonn.
- Stähelin, F., 1907² (1897): *Geschichte der kleinasiatischen Galater*, Leipzig.
- Strobel, K., 1991: Die Galater im hellenistischen Kleinasien. Historische Aspekte einer keltischen Staatenbildung, in J. Seibert (ed.), *Hellenistische Studien. Gedenkschrift für H. Bengtson*, München, 101–131.
- Strobel, K., 1994a: Galatien und seine Grenzregionen, in E. Schwertheim (ed.), 29–65.
- Strobel, K., 1994b: Keltensieg und Galatersieger. Die Funktionalisierung eines historischen Phänomens als politischer Mythos der hellenistischen Welt, in E. Schwertheim (ed.), 67–96.
- Strobel, K., 1996: *Die Galater I. Geschichte und Eigenart der keltischen Staatenbildung auf dem Boden des hellenistischen Kleinasien*, Berlin.
- Strobel, K., 1997: Galatica I. Beiträge zur historischen Geographie und Geschichte Ostgalatiens, *Orbis terrarum. Internationale Zeitschrift für Historische Geographie der Alten Welt* 3, 131–153.
- Strobel, K., 2002a: State formation by the Galatians of Asia Minor. Politico-historical and cultural processes in Hellenistic Central Anatolia, *Anatolica* 28, 1–44.
- Strobel, K., 2002b: Die Staatenbildung bei den kleinasiatischen Galatern. Politisch-historische und kulturelle Prozesse im hellenistischen Kleinasien, in H. Blum *et al.* (eds), *Brückenland Anatolien?*, Tübingen, 231–293.
- Strobel, K., 2002c: Menschenopfer und Kannibalismus. Neue Erkenntnisse zur Kultpraxis und Kultur der Keltenvölker in Kleinasien, *Antike Welt* 33, 487–491.
- Strobel, K., 2002d: Die Legionen des Augustus. Probleme der römischen Heeresgeschichte nach dem Ende des Bürgerkrieges: Die Truppengeschichte Galatiens und Moesiens bis in Tiberische Zeit und das Problem der Legionen Quintae, in Ph. Freeman (ed.), *Limes XVIII. Proceedings of the XVIIIth International congress of Roman frontier studies, held in Amman, Jordan (September 2000)*, Oxford, 51–66.
- Strobel, K. 2007a: Galatien, die Galater und die Poleis der Galater. Historische Identität und ethnische Tradition, in H. Birkhan (ed.), *Kelten-Einfälle an der Donau*, Wien (Österreichische Akademie der Wissenschaften, Phil.-hist. Kl., Denkschrift 345), 529–548.
- Strobel, K. 2007b: Die Galater und Galatien. Historische Identität und ethnische Tradition im Imperium Romanum, *Klio* 89, 356–402.
- Strobel, K., 2007c: Beiträge zur historischen Geographie Zentralanatoliens, in U. Fellmeth/P. Guyot/H. Sonnabend (eds), *Historische Geographie der Alten Welt: Grundlagen, Erträge, Perspektiven. Festgabe für Eckart Olshausen aus Anlass seiner Emeritierung*, Hildesheim (Spudasmata 114), 309–351.
- Strobel, K. 2008: Tawinija/Tavium and the Regional Hittite Road Network, in K. Strobel (ed.), *New Perspectives on the Historical Geography and Topography of Anatolia in the II and I Millennium B.C.*, Firenze (Eothen 16), 281–302.
- Strobel, in press: Ist das phrygische Kultzentrum der Matar mit dem hellenistischen und römischen Pessinus identisch? Zur Geographie des Tempelstaates von Pessinus, *Orbis terrarum. Internationale Zeitschrift für Historische Geographie der Alten Welt*.
- Strobel, K., in prep.: *Die Galater II. Galatien in hellenistischer und römischer Zeit: Geschichte, Kultur und Wirtschaft*, (Untersuchungen zur Geschichte und historischen Geographie des hellenistischen und römischen Kleinasien II).
- Strobel, K./C. Gerber, 2000: Tavium (Büyüknefes, Provinz Yozgat) – Ein überregionales Zentrum Anatoliens, *Istanbuler Mitteilungen* 50, 165–215.
- Strobel, K./C. Gerber, 2003: Tavium (Büyüknefes, Provinz Yozgat) – Bericht über die Kampagnen 2000–2002, *Istanbuler Mitteilungen* 53, 131–195.
- Strobel, K./Gerber, C. 2006: Feldforschungen in Tavium. Bericht über die Kampagne 2004, *Araştırma Sonuçları Toplantısı* 23, 359–376.

- Strobel, K./Gerber, C. 2007: Tavium (Büyüknefes, Provinz Yozgat). Bericht über die Kampagnen 2003–2005. Mit Beiträgen von E. Christof, G. Koiner, A. Puhm, S. De Martino und D. Müller, *Istanbulier Mitteilungen* 57, 547–621.
- Strobel, K./Gerber, C. 2008: Das Internationale Tavium/Tawinija-Projekt. Bericht über die Kampagne 2006, *Kazı Sonuçları Toplantısı* 29, 429–442.
- Strubbe, J.H.M., 1978: Les noms personnels dans AEMO 7 (1983) et les noms celtiques dans les inscriptions grecques de Pessinonte (avec quelques inédits), *Beiträge zur Namensforschung* 13, 361–381.
- Studien zur Ethnogenese* 1985: *Studien zur Ethnogenese*, Opladen (Abhandlungen der Rheinisch-Westfälischen Akademie der Wissenschaften 72).
- Strubbe, J.H.M., 2005: *The inscriptions of Pessinus*, Bonn (IK 66).
- Thiel, J.F., 1977²: *Grundbegriffe der Ethnologie*, St. Augustin.
- Tomaschitz, K., 2002: *Die Wanderungen der Kelten in der antiken literarischen Überlieferung*, Wien.
- Tomasello, M. (ed.), 1998/2003: *The new psychology of language I-II*, Mahwah N.J.
- Uçankuş, H.T., 2002: *Ana Tanrıça Kybele'nin ve Kral Midas'ın Ülkesi Phrygia (Kültür Rehberi)*, Ankara.
- Voigt, M.M., 2003: Celts at Gordion. The Late Hellenistic settlement, *Expedition* 45/1, 14–19.
- Waelkens, M., 1977: Phrygian votive and tombstones as sources of the social and economic life in Roman antiquity, *Ancient society* 8, 277–315.
- Waelkens, M., 1986: The imperial sanctuary at Pessinus. Epigraphic and numismatic evidence for its date and identification, *Epigraphica Anatolica* 7, 37–72.
- Weisgerber, L., 1931: Galatische Sprachreste, in R. Helm *et al.* (eds), *Natalicium. Johannes Geffcken zum 70. Geburtstag*, Heidelberg, 151–175.
- Welles, C.B., 1934: *Royal correspondence in the Hellenistic period*, London.
- Wenskus, R., 1977²: *Stammesbildung und Verfassung. Das Werden der frühmittelalterlichen Gentes*, Köln/Graz.
- Wenskus, R., 1986: Über die Möglichkeit eines allgemeinen interdisziplinären Germanenbegriffs, in H. Beck (ed.), *Germanenprobleme aus heutiger Sicht*, Berlin/New York, 1–21.
- Whitehead, A.N., 2001: *Kulturelle Symbolisierung* (ed. R. Lachmann), Frankfurt.
- Wittgenstein, L., 2001: *Philosophische Untersuchungen* (ed. J. Schulte), Frankfurt.
- Wolfram, H., 1997³: *Die Germanen*, München.
- Wolfram, H., 1998: Typen der Ethnogenese. Ein Versuch, in D. Geuenich (ed.), *Die Franken und Alemannen bis zur Schlacht von Zülpich (496/97)*, Berlin/New York, 608–627.
- Zgusta, L., 1964: *Kleinasiatische Personennamen*, Heidelberg.
- Zgusta, L., 1970: *Neue Beiträge zur kleinasiatischen Anthroponymie*, Prag.
- Zgusta, L., 1984: *Kleinasiatische Ortsnamen*, Heidelberg.

Material culture and plural identity in early Roman Southern Italy

Douwe Yntema

- 1 Introduction
- 2 The Mesagne burial
- 3 Contextualising the Mesagne tomb
- 4 Apulian elites in inscriptions and literary sources
- 5 Setting the scene
- 6 Constructing identities
- 7 Concluding remarks

References

I INTRODUCTION

Ethnicity and identities assumed by groups that believed they had a common origin or a shared past have been the subject of various recent studies.¹ This renewed focus on the different aspects of ethnicity in ancient societies follows a period in which for various reasons there was little thorough research into this subject and ethnic terms were used rather lightly (e.g. Jones 1997; Brather 2000). For instance, connections were quickly made between material culture and ethnic identity. In many cases a particular type of fibula, belt or pot was associated with an ethnic group (mostly derived from an ancient written source) and a person buried with such an ‘Etruscan’, ‘Samnite’, ‘Celtic’ or ‘Frankish’ object was identified as an Etruscan, a Samnite, a Celt or a Frank.² A burial with ‘Celtic’ armour and a host of characteristically local funerary wares in a pre-Roman, ‘native’ (i.e. non-Greek) district of southern Italy, for instance, triggered

¹ I am grateful to the participants in the Amsterdam Ethnicity Symposium who read the first drafts and commented upon this paper. The research, carried out at various sites of the south-Italian Brindisi district (Mesagne, Muro Tenente, San Pancrazio Salentino), is funded by the VU University Amsterdam and the City of Mesagne, province of Brindisi. It is being conducted within the framework of Progetto Strategico 251100 of the *Consiglio Nazionale per le Ricerche*. We are grateful to our friends and colleagues at Lecce University (Prof. Francesco D’Andria, Prof. Mario Lombardo and Prof. Grazia Semeraro), the *Soprintendenza alle Antichità* (Prof. Giuseppe Andreassi, Dr. Assunta Cocchiario, Dr. Grazia Angela Maruggi) and the Mesagne Museum (Dr. Alessia Galliano) for giving us help, support

and permission to study materials. I am also indebted to Dr. Miguel-John Versluys (Leiden University), who supplied information on the wall paintings of the Mesagne tomb and the late Dr Jaap van der Werff (Amersfoort, the Netherlands), who analysed the two amphorae found in the tomb that provided the starting point for this paper. Photographs and drawings: B. Brouwenstijn (fig. 1), Centro Studi Antonucci, Mesagne (Brindisi) (figs. 2-9), T. Derks (fig. 10).

² This approach to ethnicity has sometimes been called ‘empirical’; cf. the editorial introduction (p. 179-180) to the section ‘Burial and ethnicity’ in the conference volume Pearce *et al.* 2000.

a lively discussion on – historically attested – Celtic invasions in Italy and Celtic chieftains living among native Italians. However, tombs in a similar chronological and geographical context containing, among other objects, a ‘Greek’ panoply, have invariably been interpreted as the burials of native chieftains and have never elicited a debate on Greek invasions into native territories or Greek elites living among native south Italians.³

One of the reactions against this straightforward use of ethnic qualifications has been deconstruction.⁴ For the ancient world of the Mediterranean, however, attempts to deal with ethnic identity and ethnic labelling have already been made with considerable success since the late 1980s.⁵ It appeared that ancient written sources are crucial in discussions on ethnic identities, since – as Jonathan Hall put it – ‘ethnic identity is considered to be primarily discursive’.⁶ Although the way to ethnicity appears to be strewn with snags and pitfalls even with the help of such sources, if interpreted with caution these sources may help us to reveal how people labelled others and saw themselves in distant pasts.

Ethnic groups, as fundamentally social groups, are not ‘static and monolithic, but dynamic and fluid’.⁷ In principle, ethnic boundaries are permeable. Studies on both modern and ancient ethnic identities revealed that ethnic labelling and self-labelling are situational constructs. The same person or group may subscribe to various group identities according to the context in which he, she or it operates. It is, however, a mistake to believe that ethnic terms and labels are used lightly, according to the circumstances and purely for convenience. In many cases they appear to have deep roots indeed.⁸

Ethnic identities as perceived by groups and the *origo* myths often connected with them have been amply discussed in recent years.⁹ This paper wishes to explore more ‘individual’ dimensions of ethnic identity and ethnicity such as those discussed in Goudriaan’s *Ethnicity in Ptolemaic Egypt*.¹⁰ It appears that individuals rarely subscribe to one single identity. Therefore, the phenomenon of plural identity is one of the two aspects on which we will focus here. Since, moreover, considerable attention has been paid to the way individuals and groups label the Other, our focus here is a nuanced picture of the Self: the way in which individuals label themselves in particular situations. In doing so we may well avoid the discursively constructed bipolarity (the ‘Us’ versus the ‘Others’) that so often dominates the discussions on ethnicity: the various identities of the Self are, of course, not defined in oppositional discourse.

The second aspect to which this paper wishes to contribute is the thorny problem of the relationships between identities and material culture. We are well aware of the fact that the things we wear and use and the ways in which we speak, behave and think are often linked to the different identities we assume under various circumstances. It should be noted that these identities are not exclusively *ethnic* in nature but may often be *cultural* identities. For instance, representations found in the first millennium BC Mediterranean of people drinking while reclining on couches may at first sight look like non-Greek versions of Greek symposia and have often been interpreted in this way.¹¹ Such parties may in fact have been an

³ For a tomb with Celtic armour from the settlement of Canosa (Apulia, southern Italy), see Oliver 1968 (tomb of the 3rd century BC); Greek panoplies are found in tombs in large parts of southern Italy in the later 6th and early 5th centuries BC (e.g. Adamesteanu 1971, Nista 1978, Emanuele 1983 and Bottini 1989).

⁴ Cf. Jones 1997 and Brather 2000.

⁵ See, for instance, Goudriaan 1988, Hall 1989, Dench 1995, and Hall 1997; the papers collected in Harrison *et al.* 2002 are mostly from the 1980s and give a good impression of the state of research concerning the Greek

views of the ‘Other’ in that decade.

⁶ Hall 1997, 2; for the importance of written sources in the discussions on ethnicity, see also Malkin 2001a, 4–6, and contributions in Malkin 2001b.

⁷ Hall 1997, 34.

⁸ Cf. Malkin 2001, 16–17.

⁹ Cf. Malkin 1994 and 1998; Gehrke 2000; Brather 2000; Roymans’ paper in this volume.

¹⁰ Goudriaan 1988.

integral part of a wider *Mediterranean* elite culture and as such can be considered as displaying a *cultural* rather than ethnic identity. The person buried in a tomb containing a number of objects which we tend to read as paraphernalia of the Greek symposium may in fact have wished to display his *elite* status and not his *Greek* or *Grecian elite* status.¹² However, it is sometimes difficult – and perhaps even irrelevant – to attempt to draw a line between these two aspects of identity. The drinking party that looks like a symposium is indeed part of the ‘international’ *cultural* language of one social subgroup (the elite) of various ethnic groups. But the elite of each of these ethnic groups may have held drinking parties displaying various features that are characteristic of that particular group alone.¹³ An Athenian, for instance, may well have remarked rather disapprovingly that ‘the Etruscans admit *women* to their symposia’. Often, it seems, cultural and ethnic identities are closely interwoven.

The starting point for this discussion on identities will be the material culture from a wealthy elite burial in south-eastern Italy. An archaeological interpretation of the grave goods is followed by an analysis of written sources concerning the contemporary elite from the same area. This is done in order to gain insight into the elite network in which the deceased functioned, and to see how this particular elite perceived its own identities in various contexts. The way these identities are expressed in objects in the funerary sphere may be compared with how they are expressed in words.

2 THE MESAGNE BURIAL

On 3 May 1988 a large and mouldering palm tree, well over a hundred years old, was removed from a small *piazza* in the southern part of the town of Mesagne, in Brindisi province, southern Italy. This brought to light a very large and unusual tomb that had been enclosed and protected by the roots of the tree. The surrounding area is known to have been part of a large, dispersed necropolis with cist graves dating predominantly between the 5th and the mid-3rd century BC. Although the unusual nature of this spectacular find triggered some debate in local circles (none of which appeared in print), the documentation was only presented in local publications.¹⁴

The present-day town of Mesagne is some 20 km west of Brindisi in southern Apulia (fig. 1). The earliest settlement traces go back to the middle of the 8th century BC. The features and artefacts uncovered to date indicate that it can be counted among the settlements of the groups that inhabited the Salento peninsula in pre-Roman times. These groups are conventionally designated Messapians, since various ancient authors (both Greek and Roman) place the tribe of the *Messapioi/Messapii* in that particular area of Italy. The names *Calabri* and *Sallentini* were used for non-Greek populations of approximately the

¹¹ People who participated in these drinking parties (e.g. Etruscans or Campanians) may even have believed they were doing something Greek and have called their meeting a ‘symposium’; at the same time they must have been aware of the fact that ‘their’ symposium differed from a Greek symposium in several respects.

¹² It is perhaps symptomatic of the Graeco-centric ideas of classical archaeologists to view almost every Mediterranean or even Hallstattian drinking party from the 7th to 6th century onward as a ‘Greek’ symposium or a derivative of the Greek symposium. There is good reason to assume that the Greek symposium was, in fact, a regional, characteristically Greek variant of an element

of elite culture diffused throughout large parts of the Mediterranean; cf. paper by Crielaard, this volume (section: ‘Luxury as self-expression’).

¹³ In the ancient representations, the majority of these distinguishing features (e.g. the unwritten rules for ‘admission’, particular rituals, type of music played during the party) elude us.

¹⁴ See Cocchiari 1989 and Nitti 1989/90; short notes on this find also appeared in the Superintendency’s yearly reports (Cocchiari 1988; Guzzo 1989, 577).

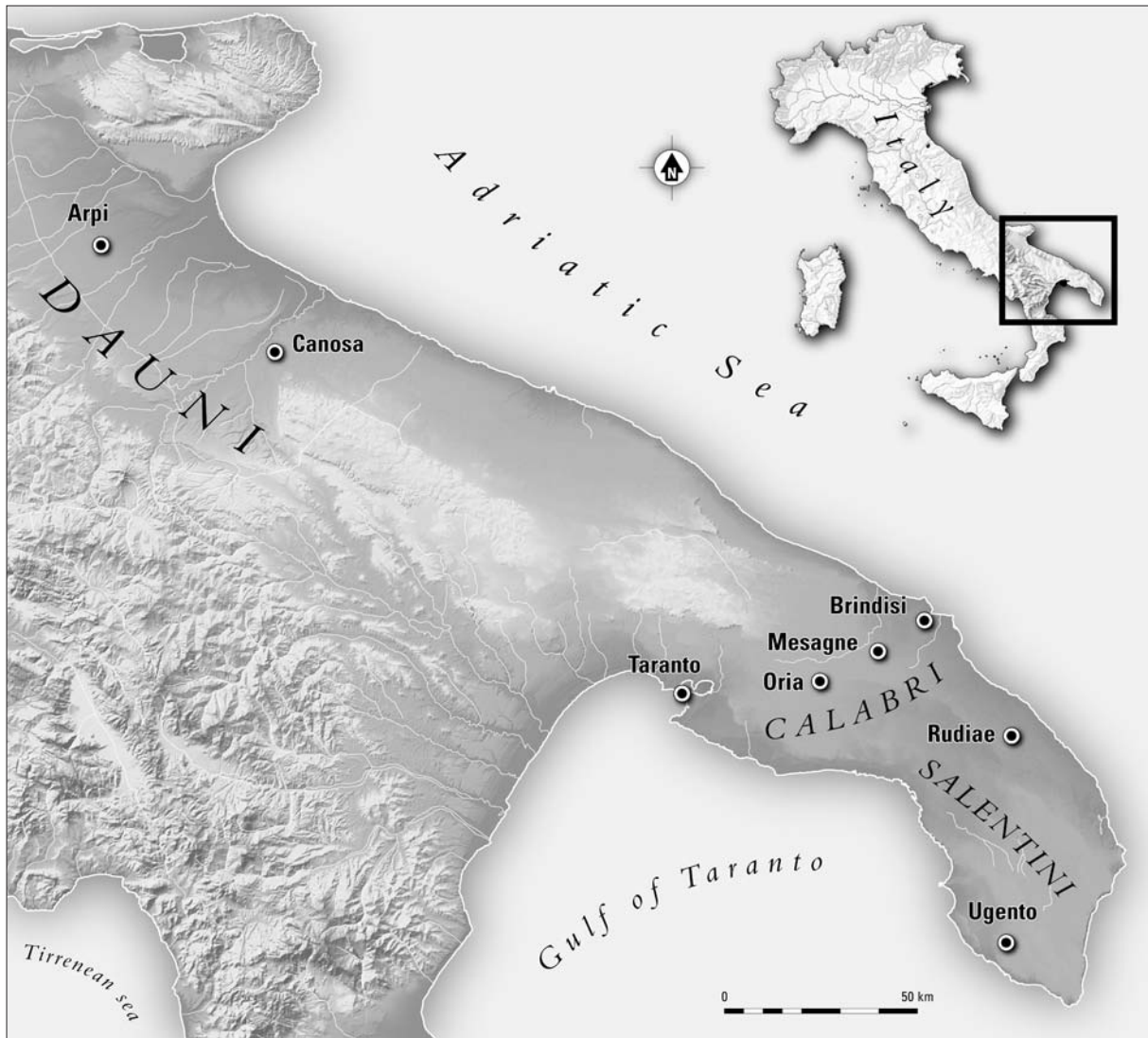

Fig. 1. Map of southeastern Italy with the most important sites mentioned in the text.

same part of Italy.¹⁵ For the sake of convenience, I shall use the conventional term ‘Messapians’ in order to indicate the non-Greek, ‘native’ groups that inhabited the Salento peninsula.

According to the *Fasti Triumphales*, the population of this area was incorporated into the Roman state from 267/266 BC onward. It was the last district of peninsular Italy to be conquered by the Romans. A decisive step in the Romanisation of this area was the foundation of a *colonia latina* in or near the native settlement of Brindisi in 244 BC.¹⁶ From this moment onward Brindisi was a town containing two substantial groups of people with vastly different roots: the original population (the ‘Messapians’) and the newcomers from central Italy (the ‘Latins’).

¹⁵ For ancient written texts on Salento, see Lombardo 1992; for the significance and use of the labels Messapioi/Messapii, Calabri and Sallentini for approximately the same population, see Nenci 1978: Messapii is often believed to be a label applied to the Salento populations in general, possibly exclusively by outsiders such as Greeks and

Romans; Calabri and Sallentini are thought to have been a kind of ‘subdivision’ that corresponded more or less to tribal realities in the 3rd and early 2nd centuries BC.

¹⁶ On the Romanisation of the Brindisi district, see Yntema 1995.

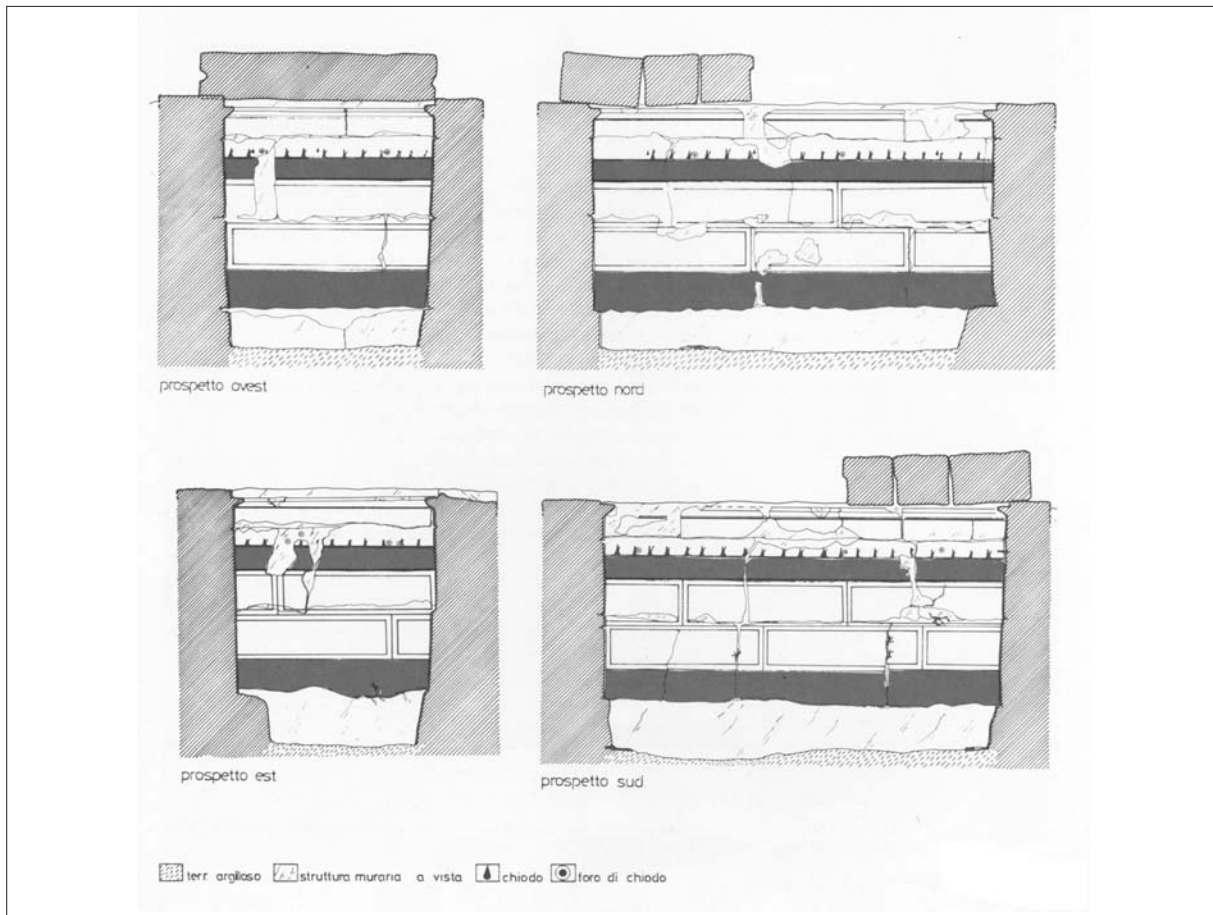

Fig. 2. Mesagne (Brindisi), via San Pancrazio, tomb 1: schematic rendering of wall paintings.

The unusual tomb was constructed in the very centre of a 5th- to 3rd-century southern necropolis of Mesagne. No marker has been found that might have indicated the location of the subterranean tomb. The walls and roof of the tomb consisted of large blocks of local limestone.¹⁷ On the inside, the tomb was 3.40 m long, 1.70 m wide, and 2.10 m deep. The inside of the tomb was covered with stucco, part of which was painted red (in bands); imitation marble blocks were painted (fig. 2) in the white zone in between. The style of the wall painting is strongly reminiscent of the so-called ‘Pompeian’ first style. It is likely to date to the first half or middle of the 2nd century BC.¹⁸ The burial chamber was at least twice as large as the average tomb of the regional elite of the later 4th and earlier 3rd centuries BC.¹⁹ Although the human bones were badly preserved, the sole occupant of the tomb could be identified as an adult of the male sex.²⁰

It was not just the sheer dimensions of the tomb that stimulated debate among regional archaeologists. Discussion focused in particular on the assemblage of objects that accompanied the deceased. The finds recovered from the tomb appeared to cover a period of some 140 to 170 years and could be dated

¹⁷ Typologically the Mesagne tomb is a so-called *tomba a semi-camera* or *Halbkammergrab* (e.g. Steingräber 2000).

¹⁸ Information supplied by dr. M.J. Versluys (Leiden University).

¹⁹ The Brindisi area in which the settlement of Mesagne is situated has no *hypogaea*, but large cist tombs. On aver-

age, such cist tombs are c. 2 m long, and approximately 1 m wide and deep. The *hypogaea* of Lecce, Rudiae and Gnathia, dating mainly to the 3rd centuries BC, are larger than the Mesagne tomb (cf. Lambolley 1982).

²⁰ See Cocchiario 1989, 11.



Fig. 3. Mesagne (Brindisi), via San Pancrazio, tomb 1: Apulian red-figured krater with funerary monument (c. 330/320 BC).

between c. 330/300–170/160 BC. Such a long time span is highly unusual in the Messapian world of Salento, where most of the artefacts found in the tombs were made especially for funerary purposes and usually cover a period of 20 to 30 years at most.²¹ Burials containing 2nd-century objects, moreover, are very uncommon in formerly native settlements of Salento, except for the two fast-growing, early Roman towns of Brindisi (*Brundisium*) and Lecce (*Lupiae*).²²

Since the practice of reusing tombs is indeed attested in the Salento peninsula, the discussion among regional scholars focused on the possibility of secondary interment.²³ The human remains, however, clearly belonged to a single individual, and all the objects – including those that had been made some 80 to 170 years before

the burial took place – were carefully arranged around the body of the deceased. The tomb itself, moreover, is almost certainly *not* a reused 4th-/early 3rd-century grave, because of its unusually large dimensions and the painted decoration displaying close affinities with the so-called ‘Pompeian first style’.²⁴ In my view, therefore, the tomb should be read as a burial from the first half of the 2nd century BC in which elements of much earlier times were consciously and purposely incorporated.

Let us take a brief look at the artefacts found in the tomb. The earliest object is an Apulian red-figured volute krater (fig. 3). This pottery class, made mainly in the Greek *polis* of Taranto, is never found during the excavations of non-Greek settlement contexts. Since the specimen under discussion displays, on both sides, a representation of a funerary monument flanked by people bearing funerary gifts, it certainly belongs to an Apulian red-figured series produced especially for funerary purposes.²⁵ Similarly decorated pots are traditionally dated to c. 330/320 BC.²⁶ Although the dating of such wares is mainly based on stylistic seriation, there is no reason to suppose that the pot under discussion was actually made after 300 BC. The red-figured krater, therefore, was some 140 to 170 years old when the Mesagne man was buried. The tomb also contained 10 pieces of Apulian Gnathia wares (fig. 4). This is a class of pottery (also produced at the Greek *polis* of Taranto) that – in the context of the native societies of Salento – was used

²¹ The mainly ceramic artefacts deposited in the tomb, datable with a precision of about 20 to 30 years, were often made especially for funerary purposes and never show signs of wear. This means that they were new or almost new when the tomb was closed.

²² These fast-growing towns were Brindisi (*Brundisium*) and Lecce (ancient *Lupiae*); burial plots with fairly modest graves of the 2nd century BC were discovered here (Andreassi/Cocciaro 1988; Giardino 1994).

²³ In the case of reuse of cist graves of the Salento area, the objects of the earlier burial are usually collected and deposited in a corner of the tomb or even outside the grave.

²⁴ See Steingraber 2000, 38 and note 18 above.

²⁵ On Apulian red-figured wares decorated with funerary monuments, see Lohmann 1979.

²⁶ Cf. Trendall/Cambitoglou 1982.



Fig. 4. Mesagne (Brindisi), via San Pancrazio, tomb 1: Gnathia krater with Dionysiac scenes (c. 310/270 BC).

exclusively in funerary and votive deposits.²⁷ On the strength of the present evidence, the earliest Gnathia pieces in the Mesagne tomb may still date to the late 4th century, but the vast majority of them belong to the first half to middle of the 3rd century BC: they were at least eighty, but some probably well over a hundred years old when they were arranged around the man in the Mesagne tomb. Next, there is a set of black gloss pots (three platters, one lamp, three spool-shaped *unguentaria* and one kantharos; fig. 5). There is nothing special about them: they were all produced in large quantities and are commonly encountered in many settlement excavations of

the district under discussion. Their shapes and fabrics, probably all from Brindisi workshops, are altogether characteristic of the first half of the 2nd century BC and display close similarities to wares associated with Brindisi coins of the earlier 2nd century BC in settlement contexts of the nearby site of Valesio.²⁸ In addition to a banded jug (again with close parallels dating to the earlier 2nd century BC), there are two complete wine amphorae of the earlier 2nd century BC, a Rhodian and a Knidian specimen (fig. 6).²⁹ By virtue of the stamps on their handles, the Rhodian specimen can probably be dated to 183 BC and the Knidian specimen to c. 183–175 BC. The metal finds consist of 23 golden oak leaves and a golden rosette belonging to a funerary crown (fig. 7),³⁰ a bronze basin, bronze clasps (belonging to a cuirass?), an iron horse bit and a bronze ring with two iron strigils.

These finds are revealing. Whilst the strigils suggest that the deceased knew something about Greek *paideia*, the horse bit, the wine amphorae and the sheer dimensions of the tomb indicate that he was also a wealthy man who rode a horse and drank good Greek wines. His high social status is, of course, stressed by the golden funerary crown, which makes him a member of a 2nd-century BC elite of southern Italy and adjacent areas. The painting of the tomb with its Pompeian-first style features is yet another reference to wealth and an international spirit, since very similar paintings decorated the houses of rich merchants – many *Italioi* among them – on the island of Delos.

²⁷ Chronologies of Gnathia wares have been presented in the 1960s and 1970s by Forti and Green, but seriation of the Hellenistic tombs of Taranto has indicated that Green's 'short' chronology is not correct: Gnathia pottery continued to be made during much of the 3rd century BC. For chronologies based mainly on stylistic seriation of Gnathia wares, see Forti 1965, Green 1968 and Green 1976; For datings based on the seriation of the Taranto burials, see Lippolis 1994 and Graepler, 1997, 58–60.

²⁸ For typo-chronologies of Apulian Black Gloss wares based on contextual evidence from settlement contexts, see Yntema 2001, 137–212.

²⁹ The height of the Rhodian amphora is 0.81 m, and that of the Knidian amphora is 0.86 m.

³⁰ The leaves of the crown have the best parallels in the late 3rd or early 2nd century; see, for instance De Juliis *et al.* 1984, 95–96 (item 26) and 98 (item 31).



Fig. 5. Mesagne (Brindisi), via San Pancrazio, tomb 1: Black gloss kantharos (c. 200/160 BC).

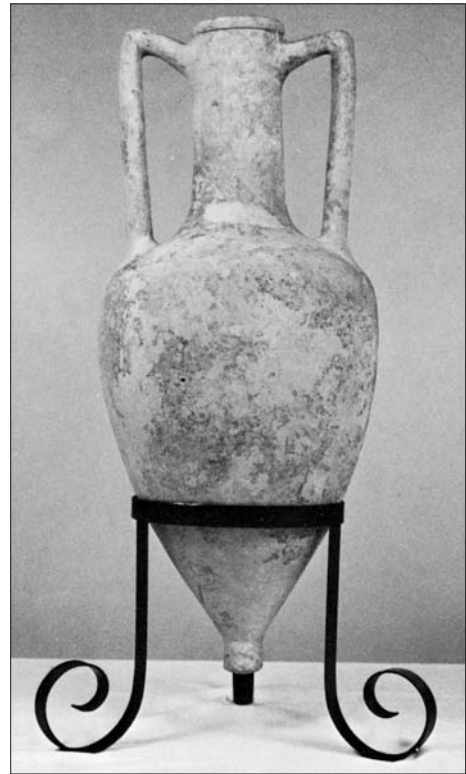
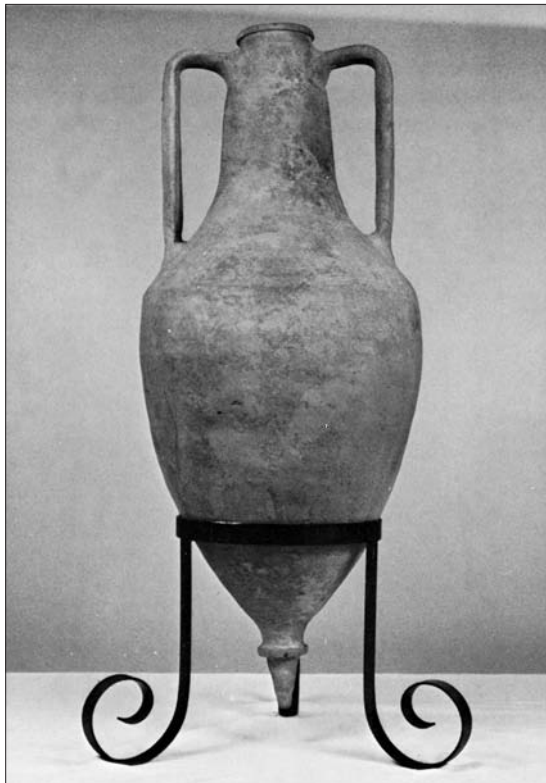

Fig. 6. Mesagne (Brindisi), via San Pancrazio, tomb 1: amphorae.



The remaining features of the tomb tell another story. The way the chamber was constructed makes the tomb itself a huge copy of the traditional Salento cist graves of the 4th and early 3rd centuries BC.³¹ This 'traditional' aspect is further stressed by the presence of one Apulian red-figured krater and the ten pieces of Gnathia pottery. Although these two classes of pottery were produced in the Greek *polis* of Taranto and only sparingly deposited in Greek graves,³² they are present in substantial quantities in the pre-Roman tombs of the 'native' Salento district. Indeed, every 4th- and 3rd-century elite tomb contains quite a number of these richly decorated terracotta vessels. The horse bit should perhaps be interpreted in the same 'traditional' vein. Finally, the 2nd-century tomb was surrounded by other graves dating to between the 5th and the mid-3rd century BC and belonging to the large southern necropolis area of the

³¹ For a large, 4th-century elite tomb of the Brindisi area, see, for instance, F.G. Lo Porto 1990.

³² Cf. De Juliis *et al.* 1984, *passim* and Graepler 1997.

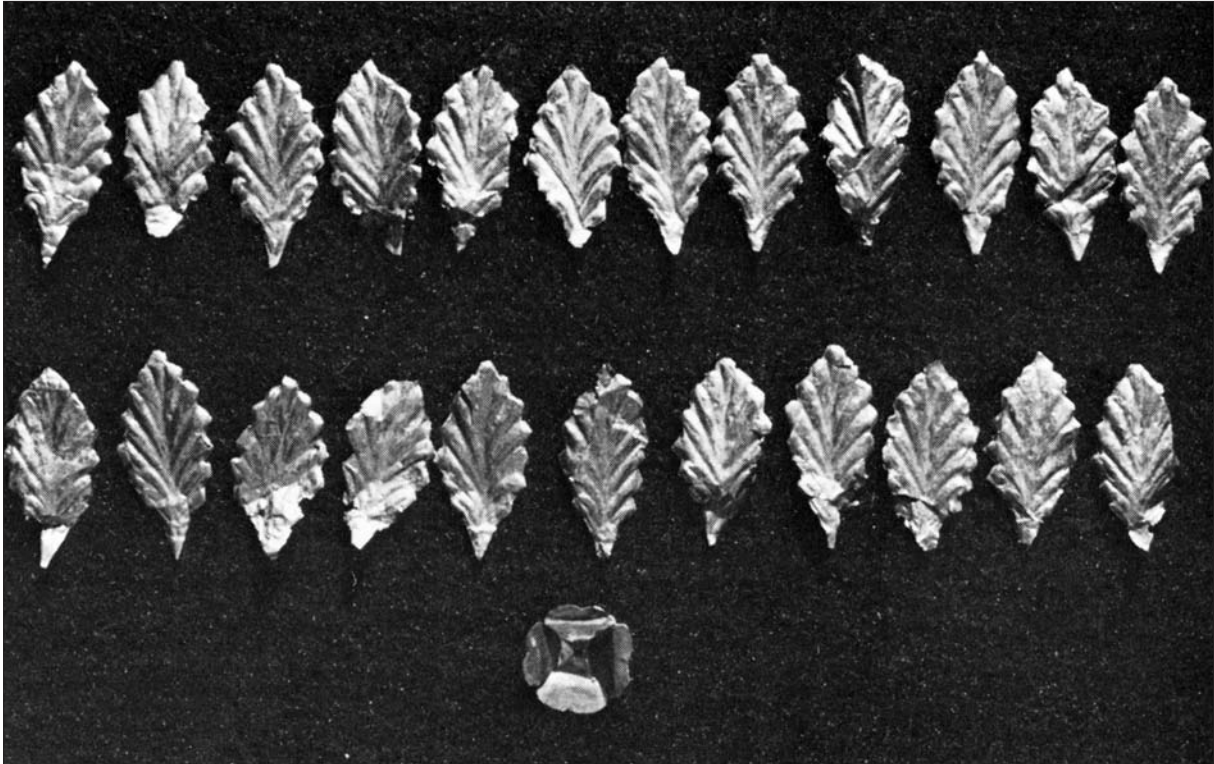

Fig. 7. Mesagne (Brindisi), via San Pancrazio, tomb 1: golden funerary crown (2nd century BC).

pre-Roman settlement of Mesagne. All these features seem to link the deceased to venerated traditions, some of them in fact elite traditions, of pre-Roman times.

Summarising the evidence produced by the tomb, one might say that the deceased, buried in the Mesagne tomb between approximately 180 and 170 BC, appears to have been a wealthy man. He or his descendants emphasised his horseman's status, drank imported wines and belonged to the regional elite of *Magna Graecia*. He claimed strong regional roots by referring to the pre-Roman elite of Salento: he was every inch a nobleman with an impressive pedigree, and what is more, a 'Salento' nobleman. Moreover, he had access to, or connections with, the world of Hellenistic Greece. He certainly did not see himself as a 'barbarian', but was or believed himself to be a highly 'civilised' person displaying Greek *paideia*: his strigils refer to the *palaestra*, his wines were Greek and the walls of his tomb were decorated in approximately the same manner as the opulent houses of the merchants on the Greek island of Delos.

3 CONTEXTUALISING THE MESAGNE TOMB

Reading the Mesagne tomb and its grave goods, seems to provide us with the image of a man that may refer to two identities. First, he (or his descendants) believed himself to be a chieftain or, perhaps better, someone in the tradition of the great Salento chiefs of the pre-Roman era. Second, he presents himself as someone who might be perceived as a Greek or, in any case, as someone deeply imbued with Greek culture.

It should be noted, however, that the image of the person presented above rests on *my* interpretations: e.g. the assumption that the 4th- and 3rd-century objects were deliberately and meaningfully placed in the Mesagne grave. Therefore, some additional evidence is needed. This can be done by searching the archaeological data for large tombs with comparable characteristics and dating to approximately the same period.

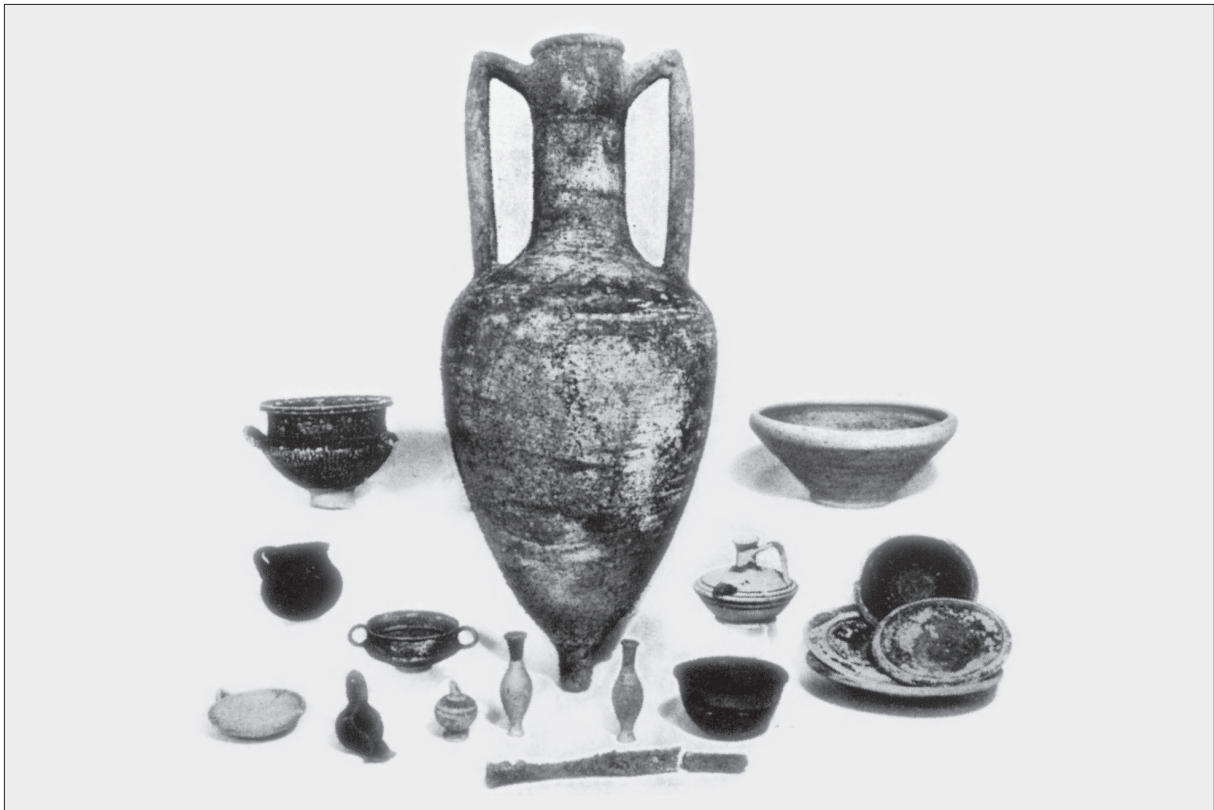

Fig. 8. Oria (Brindisi): tomb 1.

First of all, a very similar and equally large tomb with walls decorated in a comparable fashion has been found in the northern part of the present-day town of Mesagne, about 1 km from the tomb described above. Unfortunately the tomb had been robbed almost completely of its contents, but the excavator (Dr. Assunta Cocchiaro, who also excavated the 1988 tomb) assigns it to the same category. More convincing evidence comes from the settlement of Oria, some 15 km west of Mesagne. In pre-Roman times this settlement was probably one of the major tribal centres of Salento, but became a rather modest *municipium* in Roman Imperial times.³³ Here, two tombs were excavated in 1973 that are close parallels to the Mesagne tombs. These too were believed to have been fundamentally early 3rd-century tombs with secondary interment of the first half to mid-2nd century BC, but I read them as mid-2nd century tombs in which much older objects were purposely incorporated (figs. 8-9).³⁴ The first burial (tomb 1973-1) belonged to a man. It contained, *inter alia*, a Gnathia krater of about the second quarter to middle of the 3rd century BC, a spear head, probably indicative of a 4th to early 3rd-century BC warrior status,³⁵ a Rhodian amphora, and a white-slipped *lagynos* from western Asia Minor, all dating to about the middle of the 2nd century BC. The second grave (tomb 1973-3), found in the same burial plot, probably belonged to a woman. Its contents included a Gnathia kantharos dating to about the middle of the 3rd century BC, a wine amphora from Crete and an oil amphora from Brindisi.³⁶ These near-contemporary

³³ Yntema 1993, 177-226.

³⁴ The two Oria tombs have been summarily published in Lo Porto 1975, 243-344.

³⁵ For spears in native fighting and elite representations on Apulian red-figured pottery of the 4th century BC, cf.

Trendall 1971; see also Small 2000, 231: 'The spear was the standard weapon of the (4th-century) Italic warrior.'

³⁶ These amphorae were identified by the late Dr. J. van der Werff (Amersfoort, the Netherlands).

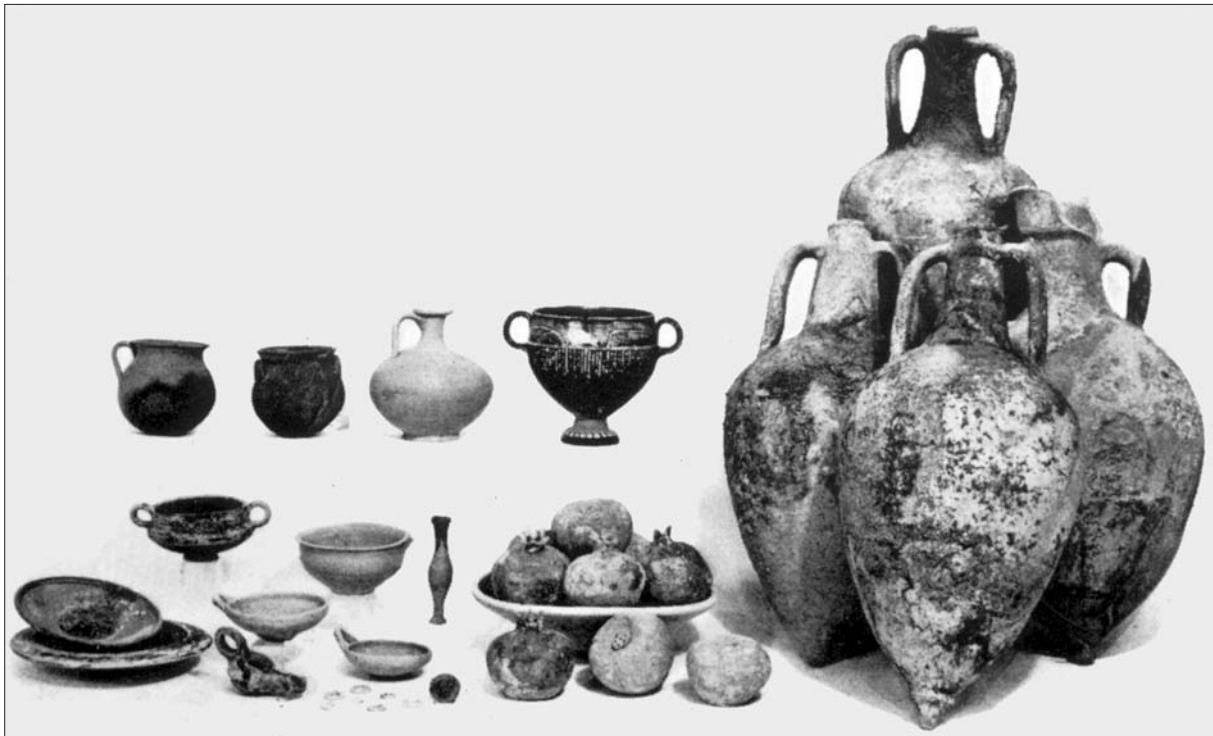

Fig. 9. Oria (Brindisi): tomb 3.

tombs from Oria, though not so wealthy as the Mesagne tomb, seem to display a similar conception. All in all, there are at least four tombs in the Brindisi district (northern Salento) that share a considerable number of features: they are unusually large, they all date to about the first half to middle of the 2nd century BC, they contain one or more objects that were between 80 and 150 years old when deposited in the tomb, and they contain objects which display links with Greece (including wine amphorae). The Mesagne tomb, excavated in 1988, is therefore not an isolated case. It has at least three parallels in the same district showing similar traits.

In order to strengthen our case still further, we will go briefly to an area outside our region of focus so far, and look at a district of northern Apulia. This is the area conventionally designated by both archaeologists and ancient historians as the territory of the Daunian tribe. While there is reason to believe that the tribal world of Salento in southern Apulia was severely eroded by about 200 BC and had almost vanished at about the middle of the 2nd century BC,³⁷ social systems of a tribal character were still very much alive in northern Apulia at about 200/150 BC.³⁸ The most notable, originally non-Roman centres here were Canosa (Latin: *Canusium*) and Arpi Nuova (Latin: *Arpi*). In these two fairly dispersed settlements lived a regional elite that had been burying its dead in sumptuous *hypogaea* and large chamber tombs since the

³⁷ For instance, the important tribal sanctuary at Oria (Monte Papalucio), some 20 km west of Mesagne, started to decline in the later 3rd century BC. It was definitively abandoned around the middle of the 2nd century BC; for a report on this sanctuary, see D'Andria *et al.* 1990, 239-306.

³⁸ This difference between northern and southern Apulia is probably caused by substantial differences in contact situ-

ations. Whilst northern Apulia was in close contact with the Sabellic tribes in the central Apennines and tribal societies on the Istrian-Dalmatian coast, the Salento district of southern Apulia was wedged between a series of Greek states (e.g. Dyrrhacchium, Apollonia and Corfu on the eastern shores of the Strait of Otranto and Greek *poleis* such as Taranto and Metaponto to the west).

late 4th century BC and that continued to do so until the 1st century BC.³⁹ It is especially towards the end of the 3rd and during the first half to third quarter of the 2nd century BC that their elite graves display features which remind us of the burials of the Brindisi district discussed above.⁴⁰ Among the grave goods deposited in these tombs are oil amphorae (mostly from the Brindisi area) and a substantial series of Greek amphorae (from Rhodes and Cos, as well as Corinthian A and B amphorae). In addition to these oil and wine amphorae, elite burials of this area contain exquisite glass vessels that are often believed to have been produced at Alexandria in Egypt.⁴¹ The finds at Canosa even included an Egyptian faience jug displaying the image of the Ptolemaic queen Arsinoe II.⁴² Here again the link between the local elites of early Roman Apulia and the Hellenistic-Greek states of the eastern Mediterranean is evident.

On the basis of the present evidence, therefore, two areas of south-eastern Italy have graves displaying substantial wealth on the one hand and connections with the Hellenistic states of the eastern Mediterranean on the other. The presence of wine and/or oil amphorae seems to be the recurring characteristic of all these Apulian elite graves. They invariably date between the later 3rd and the mid-2nd century BC. The main centres in or around which these burials are found are Brindisi in southern Apulia and both Canosa and Arpi in northern Apulia. It seems that the elites of the settlements of Arpi, Canosa and Brindisi had special links with Greek Hellenistic states during the late 3rd and first half of the 2nd century BC.⁴³

4 APULIAN ELITES IN INSCRIPTIONS AND LITERARY SOURCES

In the preceding sections the contents of a series of Apulian elite burials have been analysed. It would be interesting to try to refine the fairly hypothetic and blurred picture of these elites that results from the archaeological evidence. Let us now turn to written sources in order to see whether we can find persons belonging to the local elites who lived in the later 3rd and earlier 2nd century BC and who stemmed from the Apulian settlements of Arpi, Canosa or Brindisi.

People meeting these requirements actually appear in two types of written sources, in both literary texts and inscriptions. The first Apulian to turn up in the written evidence is a certain Bouzos, son of Orteiras. He is the person mentioned in an inscription from the island of Delos displaying an honorary decree. In the inscription dated between 241 and 232 BC, Bouzos and his offspring are granted the status of *proxenos* and *euergetes* of the sanctuary and people of Delos. The proxeny allowed him to possess plots of land and a house on the island and to sit in the first row (the *proedria*) during the games (*agones*). The same privileged status, however, obliged him to offer hospitality, help and protection to Delians coming to Canosa.⁴⁴

³⁹ See Oliver 1968; Mazzei *et al.* 1984 (both on *hypogaea* at Canosa); Mazzei 1995 (*hypogaea* at Arpi).

⁴⁰ For elite burial with gold, silver, glass and amphorae from Canosa, see Ciancio 1980 and De Juliis *et al.* 1984; for a cluster of elite burials with gold, silver, glass and amphorae from the site of Arpi, see Mazzei 1995; for comparable tombs (more isolated cases, it seems) from the north-Apulian site of Ascoli Satriano (Latin: *Ausculum*) and San Paolo Civitate (Latin: *Teanum Apulum*), see Tinè Bertocchi 1985, 209-219, and Mazzei *et al.* 1984, 227 (fig. 276).

⁴¹ The island of Rhodes is also a good candidate (cf.

Rotroff 1982, 333, notes 24 and 25)

⁴² For Ptolemaic faience oinochoe from Canosa, see Ciancio 1980, 49 (on such oinochoai in general, see Burr Thompson 1973).

⁴³ Very similar tomb contents (e.g., Rhodian amphorae, glass from the eastern Mediterranean, silver and gold objects and pottery stemming from western Asia Minor) have been found at Ancona in the Marche district; see Mercado 1976.

⁴⁴ For the inscription, see *IG XI.4*, no. 642; for the proxeny, cf. Marek 1984.

Obviously, the Canosan Bouzos was a man of high status and very considerable means with a close link to the island of Delos. Moreover, he was perhaps not the only member of the family whose name survives in the written sources. A woman called Busa, who lived in the settlement of Canosa, is mentioned by Livy.⁴⁵ She was of noble birth and wealthy. After the disastrous battle of *Cannae* in 216 BC, she helped the dispersed groups of Roman survivors that took refuge in nearby Canosa (c. 10–15 km from the battlefield), by giving them corn, clothing and ‘money for the way’. Lady Busa was greatly honoured by the Senate in Rome.⁴⁶

In the year of Hannibal’s arrival in Italy, a Brindisi man is reported to have played a rather ignoble role. According to Livy (XXI, 48) a certain Dasius Brundisinus was bribed by the Carthaginian general and surrendered the small Po valley stronghold of Clastidium to him (now Casteggio, near Pavia). In the same Punic war the name of an Arpi nobleman crops up for the first time: the turncoat Dasius Altinius, who went over to Hannibal after the battle of *Cannae* and betrayed the Carthaginian when the Romans gained the upper hand in 213 BC (Livy XXIV, 44). However, it is not until 191/190 BC that the first connection between *Arpi*, Brindisi and the eastern Mediterranean can be traced in the ancient written sources: in that year one Salsios Tagullios, son of Tagilos, from *Argurippa* (Greek for *Arpi*) was granted a proxeny by the important sanctuary of Delphi. He was not the only *Italios* to be granted that honour. The Canosan Blattos, son of Matouros, had preceded him in 195/194, whilst Gaios Statorios (Latin: Gaius Statorius), son of Gaios, from Brindisi was granted a proxeny by the sanctuary of Delphi in the same year – 191/190 – as Salsios Tagullios. These three men appear in a large *proxenos*-inscription on the so-called polygonal wall.⁴⁷ Leukios Ortesios (Latin: Lucius Ortesius) of Brindisi followed them in 168/167 BC. According to the text presented by Pouilloux,⁴⁸ Ortesius was granted the *promanteia* (the right to consult the oracle), *proedria* (seats of honour in the first row), *prodikia* (priority of trial), *asyllia* (personal safety in peace and war) and *ateleia* (exemption from public taxes). If Delphi considered an *Italios* worthy of a proxeny, he had to be rich and influential with good networks in both Greece and Italy.⁴⁹ In addition to a handful of *Rhomaioi* and one *Angkonites* (man from Ancona, central-Adriatic Italy), these three ‘Apulians’ from *Arpi*, Canosa and Brindisi were the only persons from non-Greek Italy to be granted a proxeny by Delphi in the approximately three decades covered by the large Delphic *proxenos* inscription.⁵⁰

Now it is time to focus once again on Salento. Statorius and Ortesius were not the only men professing a Salento origin who appear in Greek inscriptions of the earlier 2nd century BC. At Delos we encounter Dazos from Ugento (Latin: Dasus from *Uxentum*) in the inventory of dedicants of the sanctuary of Apollo in the 190s. Gaios Rennios (Latin: Gaius Rennius) from Brindisi was granted a proxeny by the sanctuary

⁴⁵ In the transcriptions of Messapic names, the original Messapic Z is transformed into an S in Latin: cf. Bouzos/Busus, Dazos/Dasus.

⁴⁶ Livy, XXII, 52: *Eos qui Canusium perfugerant mulier Apula nomine Busa, genere clara ac divitiis, frumento, veste, viatico etiam iuvit, pro qua ei munificentia postea ab senatu honores habiti sunt.* Since the events mentioned by Livy took place some 15 to 25 years after Bouzos (probably Busus in the Latin transcription) was granted a proxeny by the sanctuary and people of Delos, Lady Busa may, for instance, have been Bouzos’ daughter.

⁴⁷ Dittenberger 1917, 585.

⁴⁸ Pouilloux 1976, 96.

⁴⁹ For the significance of a proxeny, see Marek 1984.

⁵⁰ It is uncertain whether Ancona considered itself a Greek town or a non-Greek settlement. Some of its inhabitants presented themselves as Greeks (funerary inscriptions). But the presence of an Ancona man in the large Delphic *proxenos* inscription and the presence of elite tombs at Ancona displaying features that are closely comparable to those found in the tombs of Arpi, Canosa and Brindisi, whose elites also appear in the same large inscription, is probably not coincidental (see above note 43). A few families from central-Adriatic Ancona were probably involved in the same supra-regional elite network as the leading citizens of the Apulian settlements of Canosa, Arpi and Brindisi.

of Dodona in the 190s or 180s, and Gaios Polfennios (Latin: Gaius Pulfennius), also from Brindisi, by the *Koinon* of the Epirotes in the 170s.⁵¹ From these data it is clear that Salento, and especially Brindisi, was the home base of a handful of families of wealth and influence that maintained close relations with Greek states and sanctuaries of the middle-Hellenistic period. It should also be noted that it was precisely in this 30-year period that Rome began to intervene in Greek politics and fought its ‘Greek’ wars.⁵²

But before we enter the scenes of wars and politics, we should check whether the Salento people who appear in the Greek inscriptions actually had Salento roots, since the man in the Mesagne grave seems to emphasise a local pedigree. Of course it is important that most of these men give Brindisi as their town of origin. However, this indication is in itself not decisive: it should be observed that, in principle, these men could also stem from the group of Latin settlers that made up the body of colonists that arrived in 244 BC when the *colonia latina* of *Brundisium* was founded.

As for Lucius Ortesius of Brindisi, the inscription gives no clues as to his roots. Dasus from Ugento has the most common, characteristically regional name. He was the son of Daziskos, another name of the same Daz- type (something like John, son of Johnny). He undoubtedly had Salento roots. The same goes for Rennius and Pulfennius. Although the *gentilicium* of these gentlemen could indeed stem from central Italy, the inscriptions also give us their highly characteristic father’s names. Gaius Rennius is the son of Dazoupos, Gaius Pulfennius is the son of Dazos, both Daz- names. In the case of Statorius, the father’s name Gaius is not informative on this subject,⁵³ but the *gentilicium* of Statorius is revealing. It is very likely to be a latinisation of the pre-Roman family name of the Thaotoridas, a native elite family that appears in various inscriptions from Salento.⁵⁴ Except for Ortesius whose origin cannot be traced, the Salento people who figure in Greek inscriptions of the earlier 2nd century BC can all be shown to have solid Salento roots.

5 SETTING THE SCENE

The inscriptions cited above are pitifully short, say little about the role these people played on the 2nd-century BC stage, and give hardly any information on the networks in which they operated. From the fact that they received proxenies, we can infer that they must have been important and influential in their day. Fortunately, we have a literary source that supplies more detailed information on such a high-ranking Salento man and his connections. A nobleman from Brindisi played a crucial role at the start of the 3rd Macedonian war (172 BC). The story is told by both Livy and Appianus (*Rhomaika*, IX.7). In the text of the former the man is called Lucius Rammius, whilst Appianus speaks about (H)Erennius. Livy has the most complete version:

‘Rammius was a prominent citizen of Brundisium (princeps Brundisii), and entertained hospitably all Romans, generals as well as ambassadors. He also entertained distinguished persons of foreign states and especially members of princely houses. In consequence he became acquainted with (the Macedonian king) Perseus,

⁵¹ For Dazos, see De Simone 1964/65; for the Rennius inscription, see *Griech. Dial. Inschriften* II.1, 1339; for the Polfennios inscription, see Cabanes 1976, 554–556. A *proxenos* named ...ios, reported to come from the Salento town of Gnathia, appears in an inscription from Karthaia (Keos), but seems to belong to another period (*JG*. XII.1, no. 542; 4th century BC?).

⁵² For instance, the 2nd and 3rd Macedonian war and the

‘Syrian’ war with Antiochus III the Great and the Aetolians.

⁵³ Perhaps his father, with the typically Roman *praenomen* Gaius, was already a Roman citizen or a citizen *iuris latini*.

⁵⁴ On this *gens* with solid Salento roots, see Pagliara 1980, 225–235 (Thaotoridas, Statorius, Tutorius).

though he was far away. When a letter roused in him the hope of a more intimate friendship and of great prosperity as a result, he went to visit the king. In a short time he began to be regarded as his confidant and was drawn into his secret conferences to a greater degree than he wished. For, promising him a great reward, the king began to ask of him - since all the Roman generals and ambassadors were accustomed to avail themselves of his hospitality - that he should try to poison those about whom king Perseus should communicate with him by letter.’⁵⁵

Of course, our good man went to Rome and revealed King Perseus’ vile plot to the Senate who, thanks to the eminent Lucius Rammius of Brundisium, had an excellent excuse to attack the Macedonian king. But this passage in Livy makes it patently clear that Rammius (or whatever his real name was) was prominent in the ‘international’ networks of his day. He was close friends with the Roman elite on the one hand and princes of the Greek-Hellenistic world on the other. In the remaining part of the Rammius story, Livy suggests that Rammius was not just a close friend of King Perseus of Macedonia. Since his associate in the set-up for Perseus was King Eumenes of Pergamum, Rammius must have known the latter king as well. Eumenes may well have stayed at Rammius’ Brindisi house when he was on his way from the Senate in Rome to the sanctuary at Delphi in the same year, 172 BC. Perhaps we should read Livy’s Rammius as ‘Rennius’ (cf. Appianus’ version: Erennios), and was the Lucius Rennius in Livy’s passage on 172 BC a close relative of the Gaius Rennius who was granted a proxeny by the sanctuary of Dodona in the 190s or the 180s BC. There cannot have been too many elite families in Brindisi that played an important role in the ‘international’ scene in this short time span of about 30 to 40 years. With the Rennii (and possibly the Rammii), the Ortessii, the Pulfennii and the Statorii we are already quite well served.

This does not mean, of course, that the Greek inscriptions reveal to us the complete Salento elite with regional roots in the earlier 2nd century BC. The persons that appear in these sources are likely to be the tip of the iceberg: these are the people of the regional elite that featured in the wider Hellenistic world and had close connections with Greek and Roman elites. Other members of originally the same social group must have been somewhat less conspicuous. Since the members of the Salento elite are likely to have owned very substantial plots of land,⁵⁶ the majority of these men may well have continued to be big landowners and men of regional importance without attaining the eminent ‘international’ status of the Rennii, Ortessii, Pulfennii and Statorii. The two Oria burials discussed above – tombs without golden crowns and an excess of heirlooms referring to the local elite of the 4th to 3rd century BC – could well belong to an elite couple of strictly regional importance.

6 CONSTRUCTING IDENTITIES

The man called Rammius, Rennius or Erennios was not the only nobleman from Salento to turn up in literary sources of Greek or Roman writers. The best-known nobleman with regional roots is, of course, Quintus Ennius, the father of Latin literature whom we are actually able to see face to face (fig. 10).⁵⁷ Although only modest fragments of his numerous literary works have survived, they contain a few passages that are relevant to the present subject. Moreover, because of his great literary importance, we are relatively well informed about his life. From various passages in Roman authors we may infer that Ennius was born in 239 BC in the southern Salento town of Rudiae. He happened to be in Sardinia in 204, from

⁵⁵ Livy, *History of Rome*, XLII.17.2, author’s transl.

⁵⁶ Yntema 1995, 175.

⁵⁷ There is a portrait of Ennius in the Vatican Museum (fig.

10). Hafner (1968) moreover, tentatively identified a portrait in the Copenhagen Ny Carlsberg Glyptotek as Ennius of Rudiae.



Fig. 10. Vatican Museums: portrait identified as the Roman poet Q. Ennius from *Rudiae* (Salento).

where the elder Cato took him to Rome.⁵⁸ His Roman patron was M. Fulvius Nobilior (consul in 189 BC), whom he followed to Greece in order to besiege the town of Ambracia in the Syrian-Aetolian war (192-189). He was also closely acquainted with the Cornelii Scipiones. Quintus Ennius became a Roman citizen in the year 184. The ‘Messapian’ father of Roman literature died in Rome in the year 169 BC.

The poet Ennius was no poor immigrant in Rome.⁵⁹ He was definitely of noble birth and was believed to have the mythical king and Messapian *Urvater* Messapus among his ancestors.⁶⁰ His sister, moreover, was married to a man from Brindisi: their son was Marcus Pacuvius, the Roman playwright and painter (born c. 220, died c. 130 BC). These data suggests that Ennius’ family was involved in a regional elite network.

Since Ennius is still able to voice his views through his literary works, we can learn from him about his identities. In one of his works in Latin (i.e. in a Roman context) he stated: *Nos sumus Romani, qui fuimus ante Rudini* (‘I am a man of Rome, but formerly I was a man of Rudiae’). At the moment of writing Ennius lived in Rome, had been granted Roman citizenship and obviously felt that he truly belonged to the Roman community, whilst in an earlier stage of his existence he must have considered himself to belong to the social world of *Rudiae* in the southern part of the Salento peninsula. This statement, however, made in a Roman context, does not mean that he simply changed coats by exchanging his *Rudinus* identity for a *Romanus* one. That is not the way identities are usually constructed, and Ennius himself also tells us that he saw it differently: from 184 BC onward he was certainly not exclusively a *Romanus*. In another passage, quoted by Aulus Gellius in his *Noctes Atticae* (XVII.17.1), Ennius openly stated that he had three identities (‘three hearts’ as he puts it): *Quintus Ennius tria corda habere sese dicebat, quod loqui Graece, Osce et Latine sciret* (‘Quintus Ennius used to say that he had three hearts, since he spoke Greek, Oscan and Latin’).⁶¹ The reason he

⁵⁸ Ennius’ reasons for staying in Sardinia are not mentioned. It is, of course, tempting to assume that Ennius, as a Salentinian nobleman from *Rudiae*, commanded a Salentinian contingent that served as an occupation force in this formerly Carthaginian territory during the final episode of the 2nd Punic war (cf. Dasius Brundisius’ role as the commander of Clastidium in 218 BC).

⁵⁹ There are a few passages in ancient authors suggesting that Ennius lived poorly in Rome (cf. Suetonius, *De Grammaticis*, 1; Cicero, *Cato*, 14). These, I believe, were

written under the influence of the Hellenistic cliché of the poor poet.

⁶⁰ For instance, Silius Italicus XII, 393: *antiqua Messapi ab origine regis*.

⁶¹ *Osce* instead of *Messapice*, as we would perhaps expect, since Messapic was Ennius’ mother tongue. Either Gellius made a mistake, or Ennius also spoke the Oscan language, which was of course the *lingua franca* in large parts of central and southern Italy before the Social war of 91-89 BC.

gives for his three identities is his command of three languages; for Ennius, in his particular situation, language is obviously one of the major discriminating factors. However, by using the word *corda* ('hearts'), the poet suggests that he actually means something that went deeper than speech alone and that he is basically speaking about identities. Speaking Greek, Latin and a native language for him meant being Greek, being Roman and being a *Rudinus*, though not necessarily at the same time. In Greek contexts, such as Taranto or Ambracia, he had a Greek 'heart' and felt himself to be a Greek among Greeks: what remains of his Latin translations of Greek tragedies shows his perfect command of both Greek and Latin. When in Rome or among Romans, he did as Romans do and considered himself to be a Roman. And when Quintus Ennius returned to his home base in Salento, he spoke in his native language with Gaius Statorius and Gaius Pulfennius and became again the noble *Rudinus* his father had been. But when Gaius Statorius happened to knock at the door of Ennius' Roman house at the time when Scipio Nasica paid a visit to the venerated poet, the three of them spoke Latin, the tongue of power, or exchanged views in Greek, the language of culture.⁶²

7 CONCLUDING REMARKS

Let us turn back to the Mesagne burial with its 4th- and 3rd-century 'Messapian' heirlooms, the 2nd-century cup, platters and *unguentaria*, the Greek wines, the horse bit and the golden funerary crown. Is this assemblage of funerary objects indeed significant and indicative of identities, and did the deceased or his next of kin make deliberate choices by selecting some of these particular items above others? There were alternatives, of course. In view of the evidence presented above, the deceased is likely to have been a prominent citizen of Brindisi. However, he was not buried at the contemporary necropolis of booming Brindisi, but some 20 km to the west at insignificant Mesagne. He was, moreover, buried in the middle of a 5th to 3rd-century BC necropolis. He could have drunk the local or regional wines that filled the regionally produced Graeco-Italic amphorae; instead he chose the Greek wines from Rhodos and Knidos. In view of his wealth he might have chosen Alexandrian or Rhodian glass, like his colleagues from Ancona or the Canosa area; instead he chose an everyday dinner set of simple black gloss pots from Brindisi and was surrounded by ten 80 to 150 year old vessels which – though produced at Greek Taranto – were part and parcel of the native elite funerary tradition of the Brindisi area in his grandfather's and great-grandfather's time. The material culture of the burial suggests that the deceased had various identities, but the written sources suggest how these clues can be interpreted. They are therefore crucial if we wish to avoid ill-founded interpretations of identities expressed by material culture.

On the strength of these carefully selected finds, it should be observed that the man called Rammius, Rennius or Erennius, whom we have met above and who rubbed shoulders with both Greek princes

⁶² Cicero (*De Oratore* II, 276) tells us an amusing anecdote (sometimes supposed to stem from Ennius' own *Satires*) regarding the friendship between Ennius and Scipio Nasica (consul in 191 BC): ... *cum [Nasica] ad poetam Ennium venisset eique ab ostio quaerenti Ennium ancilla dixisset domi non esse, Nasica sensit illam domini iussu dixisse et illum intus esse. Paucis post diebus cum ad Nasicam venisset Ennius et eum ianuam quaeret, exclamat Nasica se domi non esse. Tum Ennius 'Quid! Ego non cognosco vocem' inquit 'tuam?' Hic Nasica: 'Homo es impudens. Ego cum te quaerem, ancillae tuae credidi te domi non esse, tu mihi non credis*

ipsi?' ('When Scipio Nasica came to visit Ennius and asked for him at the door, Ennius' slave girl told him that her master was not at home. But Nasica believed that her master had told her to say so and that he was actually at home. A few days later, when Ennius went to Nasica's house and asked for him at the door, Nasica cried that he was not in. 'What!' said Ennius, 'But don't I recognise your voice?' Then Nasica answered: 'You're a shameless man. When I asked for you, I believed your slave girl when she said that you were not in, and you won't even believe me!'; translation DY)

and Roman senators, answers quite well to the description of the man in the Mesagne tomb: local elite, wealthy, Greek *paideia*, and good connections in the Hellenistic-Greek world. Of course, there is a chance that the *princeps Brundisii* was actually buried in the Mesagne grave, only a few years after his performance in the Roman Senate in 172 BC. This may have happened because he had his roots in Mesagne. By about the first half of the 2nd century BC this ‘native’ settlement – like many other pre-Roman centres of Salento – had lost much of its former importance. Brindisi, with its magnificent harbour, was the boom town of the district:⁶³ it was the regional centre of power where regional politics were made. There is some evidence that the small Roman settlement underneath present-day Mesagne belonged to the *ager Brundisinus* in later Roman times.⁶⁴ If Rammius/Rennius had his roots and his lands near Mesagne, he mostly lived in Brindisi, made politics in Brindisi, used Brindisi as a spring-board for activities in Greece, but may well have been gathered to his ancestors in the settlement where his roots really lay: the dramatically declining settlement of Mesagne. By wishing to be buried there at about 170 BC, he could have stressed again his noble Salento ancestry. Perhaps he differentiated himself in this way from ‘those Latin newcomers’ who, as inhabitants of the new *colonia latina* of Brundisium, did not arrive until 244 BC, whilst *his* family – as he probably believed – had lived in the area since the great King Diomedes of Argos had founded the settlement of Brindisi, shortly after the Trojan war.⁶⁵

There is a very good chance indeed that the occupant of the Mesagne tomb was actually one of the other members of the traditional Salento elite. If the man in the Mesagne grave was not the person described by Livy as *princeps Brundisii*, it was in any case someone who knew Rammius-Rennius personally. Let us assume that his name is *not* among those mentioned above. He and Rammius-Rennius were close acquaintances. Both must have been involved in Brindisi politics, regional politics and perhaps, inter-state contacts. Sometimes they had a drink or a dinner together. Our Mesagne man may well have been present when King Eumenes of Pergamum or leading senators of Rome dined and feasted at Rammius/Rennius’ Brindisi house. Sometimes he himself may have been the host. At such occasions he must have joined toasts with the honoured princely guests and his colleagues Lucius Ortesius and Gaius Pulfennius, who may have been a decade or two younger. Perhaps, Rennius, Pulfennius and the Mesagne man took part together in the funerary rites for Gaius Statorius, the grand old Brindisi man from the grand old Salento family of the Thaothoridas, who was granted a proxeny by the important Greek sanctuary of Delphi in 191 BC.

We shall, of course, never know the name of the Mesagne man. Nor are the bones sufficiently well preserved to give him a face. But since the written evidence allows us to construct the contexts in which he functioned, we now have a fairly good idea about his status, his affiliations, his environment and the identities he assumed in various contexts. He was a man *like* Ennius and Rammius/Rennius. He had, or claimed to have had, a solid native background. He almost certainly spoke Messapic, Latin and Greek. He was wealthy. He was almost certainly a big landowner and it is highly likely that he had interests of some kind in Hellenistic-Greek states. He may, therefore, have been involved in some way in large-scale trading activities as well and could, for instance, have owned a fine house at Delos or some other place in the Greek-speaking world. Of course, he knew the members of the regional elite of the Salento district such as Rammius, Rennius, Ortesius, Pulfennius, Statorius and Ennius, but he was also acquainted in some way with political leaders of both the Roman republic in Italy and Greek states of the eastern Mediterranean. He may have visited Greece and Rome, but had almost certainly met people belonging to the Greek and Roman elites of the earlier 2nd century BC. At his interment, not only his descendants and his dependent farmers, but also the Brindisi elite would have gathered around the large grave at Mesagne that served as the starting point of this discussion.

⁶³ On the role of Brindisi in middle and late Hellenistic times, see Marasco 1988; Yntema 1995; Burgers 1998.

⁶⁵ For foundation myths of Brindisi, see Bérard 1963, 358; Malkin 1998, 240 ff.

⁶⁴ See Marangio 1975.

By sheer luck we have identified a series of probably compatible sources of various kinds that have put flesh on the meagre bones found in the Mesagne grave. These have allowed us to recapture a sense of the world inhabited by the man buried there. In his grave dating to about 175/170 BC, the Mesagne man stressed his noble Salento ancestry, his Greek *paideia* and other links with the Greek world. In exactly the same time (late 3rd and early 2nd century BC), we meet other members of his class, all from the very same district, who tell us they have a Roman, a Greek and a native ‘heart’ (Ennius), who befriended Greek kings and leading Roman senators (Rammius/Rennius) and who were *proxenoi* of Greek states and sanctuaries (Rennius, Ortesius, Pulfennius, Statorius), a status allowing them to possess a house and fields in Greece and live intensely in Greek contexts.

It was probably not only Ennius who had three ‘hearts’. Rammius, Rennius, Ortesius, Pulfennius, Statorius and the Mesagne man were not just *Brentesinoi* or *Brundisini*. When in Greece, they believed themselves to be Greeks among Greeks.⁶⁶ They were not just Greeks, because Isocrates had defined Greekness in cultural terms.⁶⁷ But since they were *proxenoi* of Greek states and sanctuaries, they were basically also members of Greek communities: they took part in Greek religious rites and were granted the honour of the *proedria* during the *agones*. The leading families of Brindisi, moreover, were important to Rome (see the role of Rammius in Livy). They may have been granted Roman citizenship, as happened to the politically less significant nobleman, Ennius of *Rudiae*. Like Ennius, some of the others may also have felt themselves to be Romans at times. There is, in any case, good reason to assume that each of them subscribed to various identities that were not just cultural, but also ethnic in nature. They had Greek and perhaps Roman hearts, but also ‘Messapian’ hearts, or whatever ethnic label they chose to give themselves. This combination of ancient written texts and archaeological evidence enables us to discover a group of persons with self-applied, multi-cultural labels who were prominent in the Hellenistic world of the late 3rd and early 2nd centuries BC.

Of course, the people discussed above had more identities than can be derived from our sources. Ennius described himself as a *Rudinus*, a *Romanus* and a *Hellenos* or *Graecus*, but when he appeared in the tribal assembly of the southern Salento Lecce district (if it still existed), he may have felt himself to be a *Salentinus*, just as the Mesagne man may have seen himself as a *Calaber* when he went to the old tribal centre of Oria to participate in the rites of the major tribal sanctuary of the north–Salento Brindisi district.⁶⁸ In this perspective it is quite remarkable that all the ‘Apulians’ we have met above identify themselves with the settlement they come from, not with the tribal groups to which they belonged: e.g., Bouzos and Blattos from Canosa, Salsios Tagullios from *Arpi*, Ennius from *Rudiae*, Statorius, Ortesius, Rennius and Pulfennius from Brindisi. Whilst this is quite understandable for the persons coming from the Salento peninsula, which is likely to have had a strong tradition of fairly independent *oppida* within a comparatively loose tribal framework,⁶⁹ it is somewhat surprising to find the same type of self-identification for the people from Canosa and *Arpi*, where tribal structures continued to be strong.⁷⁰

⁶⁶ Or perhaps Delphians among Delphians, Epirotes among Epirotes, Delians among Delians.

⁶⁷ According to Isocrates (and many Greeks of Hellenistic times), Greekness was something that could be acquired following a period of apprenticeship (Hertog 2001, 80 and 97); see also Said 2001, 279.

⁶⁸ For Calabri and Salentini as labels for different groups on the Salento peninsula, see note 15. For the probable tribal sanctuary of Oria–Monte Papalucio, see note 37.

⁶⁹ Burgers 1998, 259–263.

⁷⁰ On the one hand, perhaps, there may be a very simple explanation for this phenomenon. It should be noted

that these ‘Apulians’ appear in *Greek* proxenos inscriptions. The Greeks appearing in the same inscriptions are invariably presented with their name, their father’s name and their place of origin. This Greek automatism of giving the *town* of provenance in such inscriptions could also have applied when *Italioi* were granted a proxeny. On the other hand, it should be noted that in the Lower Rhine area people identify themselves initially with the tribal label (e.g. *Ubius*) and in a somewhat later moment with the town they come from, e.g. *Agrippinensis* (see paper by Derks in this volume).

Another remarkable aspect is that the Mesagne man, who was probably an important citizen of the *colonia latina* of Brindisi and may indeed have been a *cives Romanus*, seems to display no signs of this Roman or Latin identity in his grave. It must have been as important to him as it was to Quintus Ennius. In fact, one may well ask what sign of 'Roman-ness' could have been given to us by a highly prominent citizen of Brindisi or his next of kin in the context of Salento funerary practices around 170 BC. Probably, the most conspicuous sign of Roman-ness was the toga. Therefore, the Mesagne man may have been buried in the typically Roman toga which rarely leaves traces in the archaeological record. It should be remembered, however, that material culture can indeed be used to express both ethnic and cultural identities, but that only some of the personal identities are stressed by means of material culture, and only, of course, under particular circumstances.

REFERENCES

- Adamesteanu, D., 1971: Una tomba arcaica di Armento, *Atti e Memorie della Società Magna Grecia* 11-12, 83-92.
- Andreassi, G./A. Cocchiaro, 1988: *La necropoli di Via Cappuccini a Brindisi*, Fasano.
- Bérard, J., 1963: *Storia delle colonie greche dell'Italia meridionale*, Torino.
- Bottini, A., 1989: La panoplia lucana del Museo Provinciale di Potenza, *Mélanges de l'École Française de Rome, Antiquité* 101, 699-715.
- Brather, S., 2000: Ethnische Identitäten als Konstrukte der frühgeschichtlichen Archäologie, *Germania* 78, 139-178.
- Burgers, G.-J., 1998: *Constructing Messapian landscapes. Settlement dynamics, social organization and culture contact*, Amsterdam (Dutch Monographs on Ancient History and Archaeology 18).
- Burr Thompson, D., 1973: *Ptolemaic oinochoai and portraits in faience*, Oxford.
- Cabanes, P., 1976: *L'Épire de la mort de Pyrrhos à la conquête romaine (272-167)*, Paris.
- Ciancio, A., 1980: I vetri alessandrini rinvenuti a Canosa, in A. Riccardi/A. Ciancio/M. Chelotti (eds), *Canosa I*, Bari, 31-66.
- Cocchiaro, A., 1988: Mesagne 31.4. Via S. Pancrazio, *Taras VIII* 1-2, 144-146.
- Cocchiaro, A., 1989: *Nuovi documenti dalla necropoli meridionale di Mesagne*, Fasano.
- D'Andria, F., et al. 1990: *Archeologia dei Messapi*, Bari (Exhibition catalogue Lecce, 1990/1991).
- De Juliis, E.M., et al. 1984: *Gli ori di Taranto in età ellenistica*, Milano (Exhibition catalogue Brera).
- Dench, E., 1995: *From Barbarians to new men. Greek, Roman and modern perceptions from the central Apennines*, Oxford.
- De Simone, C., 1964/65: Zur Geschichte der messapischen Sprache, *Indogermanische Forschungen* 69, 20-37.
- Dittenberger, G., 1917: *Sylloge Inscriptionum Graecarum* vol. II, Leipzig.
- Emanuele, P.D., 1983: *Armour and weapons from pre-Lucanian Basilicata*, Ann Arbor (PhD dissertation Austin, Texas).
- Forti, L., 1965: *La ceramica di Gnathia*, Napoli.
- Gehrke, H.-J., 2000: Mythos, Geschichte und kollektive Identität. Antike Exempla und ihr Nachleben, in D. Dahlmann/W. Potthoff (eds), *Mythen, Symbole und Rituale*, Frankfurt am Main, 1-24.
- Giardino, L., 1994: Per una definizione delle trasformazioni urbanistiche di un centro antico attraverso lo studio delle necropoli: il caso di Lupiae, *Studi di Antichità* 7, 137-203.
- Goudriaan, K., 1988: *Ethnicity in Ptolemaic Egypt*, Amsterdam Amsterdam (Dutch Monographs on Ancient History and Archaeology 5)..
- Graepler, D., 1997: *Tonfiguren im Grab. Fundkontexte hellenistischer Terrakotten aus der Nekropole von Tarent*, München.

- Green, J.R., 1968: Some painters of Gnathia vases, *Bulletin Institute Classical Studies London* 15, 34-50.
- Green, J.R., 1976: *Gnathia pottery in the akademisches Kunstmuseum Bonn*, Mainz.
- Guzzo, P.G., 1989: Attività archeologica in Puglia nel 1988, in A. Stazio/R. Vitale (eds), *Un secolo di ricerche in Magna Grecia. Atti del ventottesimo Convegno di Studi sulla Magna Grecia, Taranto 1988*, Taranto, 567-581.
- Hafner, G., 1968: *Das Bildnis des Q. Ennius. Studien zur römischen Porträtkunst des 2. Jahrhunderts v. Chr.*, Baden-Baden (Deutsche Beiträge zur Altertumswissenschaft 20).
- Hall, E., 1989: *Inventing the Barbarian. Greek self-definition through tragedy*, Oxford.
- Hall, J., 1997: *Ethnic identity in Greek antiquity*, Cambridge.
- Harrison, T., et al. 2002: *Greeks and Barbarians*, Edinburgh.
- Hertog, F., 2001: *Memories of Odysseus. Frontier tales from ancient Greece*, Edinburgh.
- Jones, S., 1997: *The archaeology of ethnicity. Constructing identities in the past and the present*, London/New York.
- Lambole, J.-L., 1982: Les hypogées indigènes apuliens, *Mélanges de l'École Française de Rome, Antiquité* 94, 91-148.
- Lippolis, E., 1994: La necropoli ellenistica. Problemi di classificazione e cronologia dei materiali, in *Catalogo Museo Nazionale Archeologico di Taranto III. 1*, Taranto, 239-281.
- Lohmann, H., 1979: *Grabmäler auf unteritalischen Vasen*, Berlin.
- Lombardo, M., 1992: *I Messapi e la Messapia nelle fonti letterarie greche e latine*, Galatina.
- Lo Porto, F.G., 1975: L'attività archeologica in Puglia, in *Orfismo in Magna Grecia, Atti del XIV Convegno Int. di Studi sulla Magna Grecia, Taranto 1974*, Napoli, 337-350.
- Lo Porto, F.G., 1990: Oria I. Ritrovamento di tombe nel rione Maddalena, *Studi di Antichità* 6, 101-117.
- Malkin, I., 1994: *Myth and territory in the Spartan Mediterranean*. Cambridge.
- Malkin, I., 1998: *The returns of Odysseus*. Berkeley.
- Malkin, I., 2001a: Introduction, in I. Malkin (ed.), *Ancient perceptions of Greek ethnicity*, Cambridge (Mass.)/London, 1-28.
- Malkin, I. (ed.), 2001b: *Ancient perceptions of Greek ethnicity*, Cambridge (Mass.)/London.
- Marangio, C., 1975: La romanizzazione dell'Ager Brundisinus, *Ricerche e Studi Brindisi* 8, 105-133.
- Marasco, G., 1988: *Economia, commercio e politica nel Mediterraneo fra il III e il II secolo a.C.*, Firenze.
- Mazzei, M., et al. 1984: *La Daunia antica. Dalla preistoria all'altomedioevo*, Milano.
- Mazzei, M., 1995: *Arpi, l'ipogeo della Medusa e la necropoli*, Bari.
- Marek, Ch., 1984: *Die Proxenie*, Frankfurt am Main.
- Mercando, L., 1976: L'ellenismo nel Piceno, in P. Zanker (ed.), *Hellenismus in Mittelitalien, Kolloquium Göttingen 1974*, Göttingen, 160-218.
- Nenci, G. 1978: Per una definizione della Iapigia, *Annali Scuola Normale Pisa* 8, 45-58.
- Nista, L., 1978: Osservazioni sulla tomba IV di Noicattaro, *Archeologia Classica* 30, 1-30.
- Nitti, A., 1989/90: Tomba a semicamera dalla necropoli meridionale di Mesagne, in *Castrum Medianum. Quaderni di Storia, Arte, Archeologia e Tradizioni Popolari* 4, 41-68.
- Oliver, A., 1968: *The reconstruction of two Apulian tomb groups*, Bern (Antike Kunst, Beiheft 5).
- Pagliara, C., 1980: Note di epigrafia salentina, IV, *Studi di Antichità* 1, 225-235.
- Pearce, J./M. Millett/M. Struck (eds), 2000: *Burial, society and context in the Roman world*, Oxford.
- Poilloux, J., 1976: *Fouilles de Delphes. Tome III, Epigraphie, fasc. IV. Les inscriptions de la terrasse du temple et de la région nord du sanctuaire, nos. 351-510*, Paris.
- Säid, S., 2001: The discourse of identity in Greek rhetoric from Isocrates to Aristides, in I. Malkin (ed.), *Ancient perceptions of Greek ethnicity*, Cambridge (Mass.)/London, 275-299.
- Rotroff, S.I. 1982: The dating of Hellenistic luxury table ware, *Hesperia* 51, 329-337.
- Small, A.M., 2000: The use of javelins in central and south Italy in the 4th century BC, in D. Ridgway et al. (eds), *Ancient Italy in its Mediterranean setting. Studies in honour of Ellen Macnamara*, London (Accordia Specialist Studies on the Mediterranean 4), 221-234.

- Steingraber, S., 2000: *Arpi, Apulien, Makedonien. Studien zum unteritalischen Grabwesen in hellenistischer Zeit*, Mainz.
- Tinè Bertocchi, F., 1985: *Le necropoli daunie di Ascoli Satriano e Arpi*, Genova.
- Trendall, A.D., 1971: *Gli indigeni nella pittura italiota*, Taranto.
- Trendall, A.D./A. Cambitoglou, 1982: *The red-figured vases of Apulia, vol.II: Late Apulian*, Oxford.
- Wippel, W., 2002: The construction of the 'Other', in T. Harrison (ed.), *Greeks and Barbarians*, Edinburgh, 278-310.
- Yntema, D.G., 1993: *In search of an ancient countryside. The Free University field survey at Oria, Province of Brindisi, South Italy, 1981-1983*, Amsterdam.
- Yntema, D.G., 1995: Romanisation in the Brindisino, Southern Italy. A Preliminary Report, *Bulletin Antieke Beschaving* 70, 99-123.
- Yntema, D.G., 2001: *Pre-Roman Valesio. Excavations of the Amsterdam Free University at Valesio, province of Brindisi, southern Italy I. The Pottery*, Amsterdam.

Foundation myths in Roman Palestine. Traditions and reworkings

Nicole Belayche

- 1 Introduction
- 2 Coinage as a medium for defining civic identities
- 3 Historical and cultural context
- 4 Roman foundation myths in colonies
- 5 The creation of a Greek foundation myth in Scythopolis
- 6 A Syrian foundation myth in Ascalon
- 7 Foundation myths in bicultural, Graeco-Semitic cities
- 8 Conclusion

Abbreviations

References

I INTRODUCTION

The Roman province of Judaea (Syria-Palestine from the 2nd century onwards) was founded in the first half of the 1st century,¹ replacing the independent Herodian state.² In the preceding centuries (beginning with the Alexandrian conquest of the Achaemenid realm), Hellenistic influences had been spreading throughout the country of the Jews, even at the time when a Jewish monarchy was reestablished: mainly in Greek cities on the coast, and as far afield as Jewish cities like Jerusalem (cf. map, fig. 1), as we know from the internal conflict under the Maccabees. In accordance with the well-known Greek tradition of civic self-assertion,³ many cities claimed to have been founded by gods or heroes. Most looked to Greek origins; some coastal cities, however, argued for a Semitic foundation, while others, as we shall see, had points of reference that were more varied. Although the antiquity of their foundations and the fact that they all underwent a process of Hellenisation may partially explain the diversity of these claims, it does not do so fully. In fact, Greek cities, founded by the Ptolemies or Seleucids, followed either local or imported traditions, whether Egyptian, Syro-Phoenician or Canaanite.⁴ These traditions continued with varying strength beneath an uneven layer of Hellenism or alongside authentic Greek ones.

Claiming a mythical foundation as a way of defining one's identity was not a new phenomenon in the Roman period.⁵ However, the process of reviving ancient mythical traditions, or of creating new mythical points of reference, gathered momentum from the era of the Antonines – a time of growing urbanisation. Thanks to the valuable studies of L. Robert, M. Sartre and F. Millar, among others, we know that *agônes* between cities jealous of their image generated the same trend throughout the Roman East.⁶

¹ I wish to thank T. Derks for his close reading of the manuscript and F. Lachaud, M. Lobban and A. Visser for their correction of the English text.

² Eck 2007a.

³ Malkin 1987 and Bouffartigue 1996.

⁴ Schürer *et al.* 1979 (vol. II), 85-183; Cohen 2006, ch. 5.

⁵ Hall 2002; Rogers 1991; Bruit Zaidman/Gherchanoc 2006.

⁶ Robert 1977; Sartre 1991; Millar 1993.

Does this mean that the Palestine example followed the norm? The ethnic and religious composition of the province renders such a conclusion doubtful. In fact, the assertion of mythical foundations went further than the simple expression of membership of the Graeco-Roman *oikoumenè*: it was also a means of parting themselves from the Jewish population, who had previously been masters of the land, and to secure the province's normalisation within the Roman world.

2 COINAGE AS A MEDIUM FOR DEFINING CIVIC IDENTITIES

The evidence for this comes from a variety of sources, including late mythographers who collected or reworked traditions, no matter how contradictory they were. The most significant information derives from coins, which conveyed powerful messages to contemporaries. Civic coinage gave communities an opportunity to show themselves off.⁷ Coins displayed their loyalty to the Empire and the holder of *imperium*, set against a background of glorification of the city and its points of reference.⁸ They were the medium through which the local elite expressed its civic pride and prestige in an official representation of the city's ideological position.⁹ Hence, the repetitive character of figurations on coins from one city to another.¹⁰ Indeed, they all drew heavily on the same repertoire of themes and forms, fashionable in the East in this period: where cities did not exchange moulds, models or engravers, they inspired one another. They all felt an equal pride in the exaltation of their image. However contrived the aetiologies might have become, they all desired, wherever possible, to link themselves to a Greek (or at least a Hellenised) mythological descent, since this was the only glorious one. And yet, not all cities were able to present such an image of themselves, either because (as with Caesarea Maritima) their history was too recent – and consequently too historical – or (as in Sepphoris-Diocaesarea) because they were known as Jewish centres and remained so. Others, however, such as the Roman colony of Aelia Capitolina, were able to borrow a ready-made myth because they were new cities.

3 HISTORICAL AND CULTURAL CONTEXT¹¹

In order to understand the various ways in which foundation myths were manipulated, it may be helpful to recall briefly the situation of Syria-Palaestina from the time of Hadrian. Ancient Palestine's singularity derives from the fact that this was the 'Promised' Land of Canaan, where, according to the Holy Scriptures, 'milk and honey flows'. It was a land with a single national God within a polytheistic, initially Greek and then Roman environment, organised on the basis of civic and/or ethnic identities. However, the monotheistic Jewish population were never the sole inhabitants of the country. As far as we can see – and the Old Testament offers the first evidence of this –, Iudaea-Palaestina was peopled by various groups, each with their own language, culture and religion. After the revolt of Galilee under Trajan and the failure of the Second Jewish Revolt, known as the Bar Kokhba war (in 132/136),¹² the new province of Syria-Palaestina was no longer distinguished as the land of the Jews, despite its rabbinical Judaism. Rather, the religious mix created in the Roman melting pot was gaining ground: at the beginning of the 4th century, Eusebius of

⁷ Millar 1993, 230: 'the most deliberate of all symbols of public identity'; Howgego/Heuchert/Burnett 2007.

⁸ E.g. the young Commodus' symbolical *adventus*, Kadman 1956, n° 65, and Gaza coins dated by Hadrian's ἐπιδημία in 130, *BMC Pal.* n° 14-55. Harl 1987, 31-51 and pl. 22.

⁹ For the imperial coinage, see Veyne 2002, 15-21.

¹⁰ Harl 1987, 52-81; Belayche 2003.

¹¹ For an exhaustive study, see Belayche 2001.

¹² Eck 2007b.

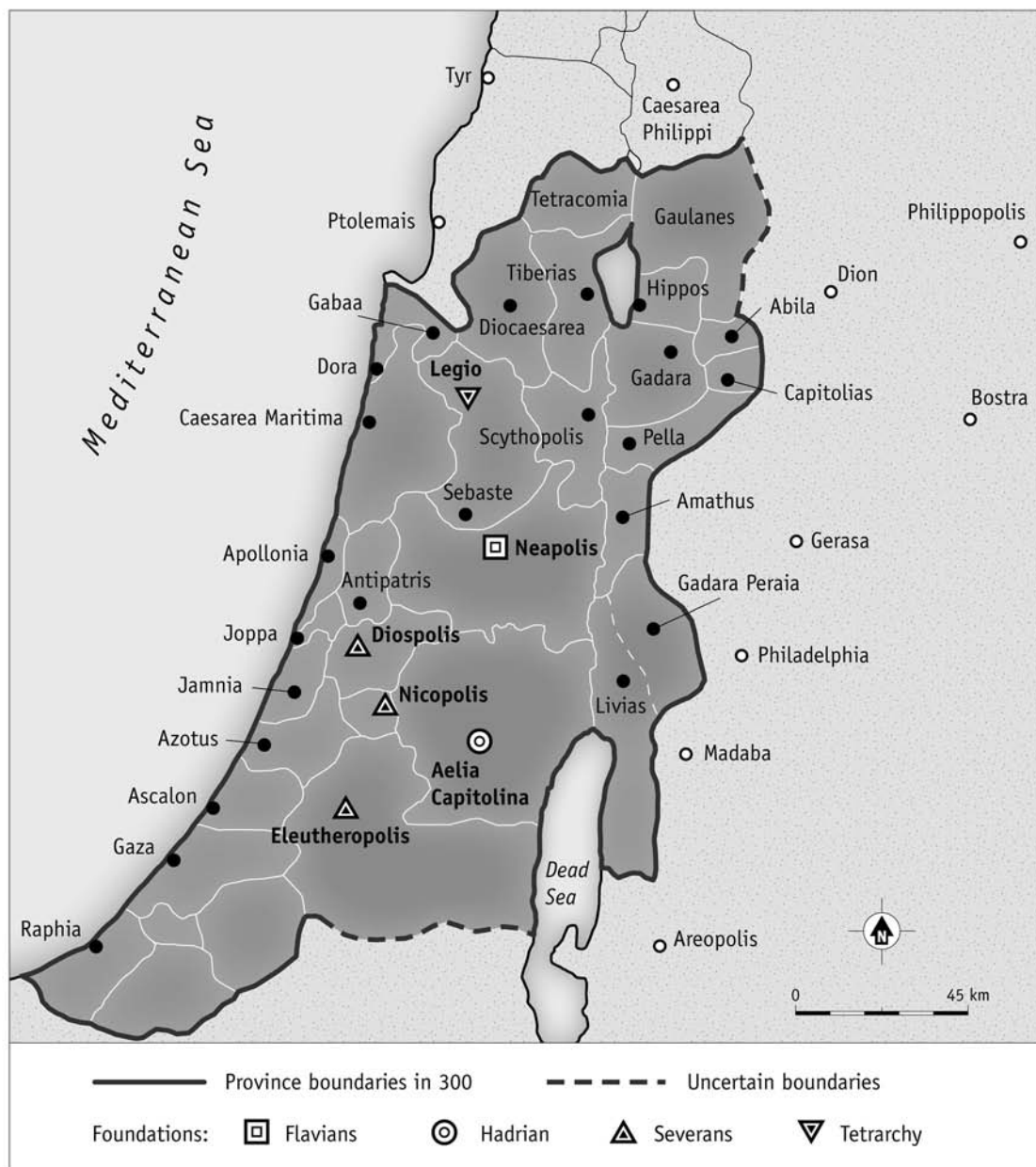

Fig. 1. Map of the cities in Roman Palestine listing the successive foundations from the Flavians until the 4th century (design IRSAM-UPPA: Monique Morales).

Caesarea listed in his *Onomasticon* a mere eighteen mono-ethnic villages out of more than nine hundred cited.¹³ After the First Revolt (66–73), Graeco-Romanisation had already increased in some cities, such as Caesarea Maritima, which no longer had a Jewish population. From 117–120 onwards, two legions were stationed permanently in the province, which became a consular one. Jewish losses during the Second Revolt and reinforcement of the Roman presence changed the ethnic balance.¹⁴ A good indication of this is the widespread use of the Latin language, which was very unusual in an Eastern province.¹⁵ In quantita-

¹³ Isaac 1998b; more generally, Schäfer 2003.

¹⁴ Belayche 2004.

¹⁵ Isaac 1990a, 304–307; Geiger 1996, 39–57; Eck 2003 and 2007a, 157–200.

tive terms, Graeco-Roman populations were in the majority, and Jews were even exiled by law from the Judaeen district and its heart, Jerusalem. This religious and cultural resettlement happened at a time when Hadrian was attempting to spread Hellenism. During his second Palestinian tour in 129/130, he showed his zeal towards Zeus Olympios on Mount Gerizim and sought to embellish the province along Graeco-Roman lines. He monumentalised the Mambre sanctuary, close to Hebron, and transformed Jerusalem into a Roman colony, giving it a new name.¹⁶ In return for his benefaction, religious honours were bestowed on him, including two *Hadrianeia* in Caesarea and Tiberias and a festival in Gaza, to mention only the main ones.¹⁷ The philhellenic example given by the emperor himself, at a time when Jews were reorganising their life around the *Torah*, created favourable conditions for pagan populations to craft an image of their own cities, now part of what was almost an ordinary province.

In Palestine, Rome enforced its usual territorial policy of maintaining autonomous *poleis*, which were charged with heavy administrative burdens, including fiscal levies. The majority of the civic settlements in the area dated from earlier periods, for urbanisation had been the means of occupying territory since Hellenistic times, if not before.¹⁸ There were about twenty-five cities of varying status (cf. map, fig. 1). One of the main roots of 'Romanisation' – conveying Hellenism as well¹⁹ – was the intense urbanisation that took place from the time of the Flavians,²⁰ and was comparable to what was happening in Syria and, to a lesser degree, in Arabia after AD 106. But in fact, Roman power did not create cities *ex nihilo*: emperors modified the status of existing settlements, promoting simple townships to municipal or colonial rank. The Severan period in particular was characterised by numerous alterations in status, with foundations of colonies in line with the general policies of the dynasty.²¹ An urban network secured Roman order in a region coveted by enemies both from within and without. For instance, during the war of succession of 193–196, the granting or denial of civic status was used by Septimius Severus as a means of rewarding or punishing political choices: while Neapolis was favoured, Sebaste was punished, these two fates echoing the opposing destinies of Nicaea and Nicomedia in Bithynia. Such favour encouraged loyalty and an adherence to the dominant culture.

The presence of sizeable pagan or mixed cities set the tone for regional behaviour.²² Nomenclature documented by funerary inscriptions²³ and the use of epigrams²⁴ testifies to the vitality of Hellenism, which was to be found in every field. From the first half of the 2nd century, local elites competed with each other for the importance of their benefaction, following the example of Transjordanian cities that used their prosperity to fund monumental urban amenities and festivals.²⁵ Theatres and other buildings, which placed a heavy burden on local finances, revealed the cultural tastes and religious attitudes of the

¹⁶ Ptolemy, *Geography* V, 15, 5: 'Jerusalem that we call today *Aelia Capitolina*'; Eusebius, *HE* IV, 6, 4.

¹⁷ Epiphanius, *Panarion* 30, 12, 2; *Chronicon Pascale* I, 474 (Dindorf).

¹⁸ Jones 1930; Schürer *et al.* 1979 (vol. II), 85–97. On the coast, at least, the list of cities in the Roman period is almost identical to that of 'Hellenistic cities' studied by Schürer *et al.* 1979 (vol. II), 97–184. Frézouls 1988 examines methodological problems.

¹⁹ Sartre 1991, 390. For a review by dynasty (from the Flavians to the Severans), see Isaac 1990b; more generally, see Woolf 1997.

²⁰ Isaac 1990a, 344–361.

²¹ Millar 1990, 31–56. For the period from the Severans to Constantine, see Jones 1971, 273–281.

²² Lapin 2000, 74–80.

²³ E.g., in the neighbourhood of Lydda (latterly Diospolis), Savignac 1904, 83–84, n° 5: 'Marcion son of Kronidès, native of Pelle'. For a mixed Roman and Palestinian nomenclature in an inscription from the Golan, see Applebaum/Isaac/Landau 1981–1982, 109, n° 19: Titus Iulianus Zabaïos.

²⁴ *SEG* 7 (1934), 329; 14 (1957), 847.

²⁵ For the moral obligations behind such benefactions, compare Julian the emperor's famous judgment about the situation in Syrian Antioch: 'Money spent on such festivals gives your curiales much more credibility and renown in others' eyes than Solon had after he met Croesus'. Julian, *Or.* VII (*Misopogon*) 8 [342c].

majority of the civic population. Revealingly, although the Mishnah forbade trade in bears and lions, since they were sold for the circus games,²⁶ the people of all the cities, ancient and newly founded alike, had the same recreational activities and types of display as those of any town in the empire. This can be seen from the list of victories of one wrestler, summed up in an inscription from Aphrodisias in Caria dated to about 165. The text reads like a roll-call of the eastern *oikoumenè*, in which Palestinian cities hold a good position: *In Damascus ... , in Berytos ... , in Tyre ... , in Caesarea Stratonis the men's pancratium, in Neapolis of Samaria the men's pancratium, in Scythopolis, the men's pancratium, in Gaza the men's pancratium, in Caesarea Parias the men's pancratium twice, in Hierapolis ...*²⁷ In Palestine, unlike neighbouring Syria and the Hauran, the Semitic pagan background had been severely attacked by the Hasmonaean reconquest, causing the destruction of many ancient sanctuaries, such as those of Ascalon and Gaza. In the mid-2nd century BC, the Jewish monarchy, heirs to the Maccabees and based on theocratic principles, made it a point of honour to destroy pagan cults.²⁸ Once Pompey had liberated the coastal cities, the sanctuaries that were rebuilt promoted the revival of local non-Jewish traditions, but this took place in a definitely Graeco-Roman cultural atmosphere.

From the Hellenistic period, onwards and despite Jewish parentheses, civic foundation legends, recast in a Greek mould, suggested that it was only Greek founders who were capable of promoting cities in a Hellenised world. At Tell Abu Shusha-Gabba Hippeon, founded by Herod to the north east of Dora, a Greek inscription honours *Abdagos, son of Alexandros, first citizen of the city and its founder*. The citizen's name – *slave of Dagon* – evokes the Phoenician cult of the great god of Arados, which had been wiped out by the Maccabees at Azotus in 148-146 BC.²⁹ But the honour granted to the *ktistès* shows that the mental attitude was Greek. This did not prevent the perpetuation of Syrian myths in a Hellenised form.³⁰ If the foundation was voluntary, however, the reference could be Roman, as in Aelia Capitolina.

4 ROMAN FOUNDATION MYTHS IN COLONIES

In Roman colonies, which were considered 'miniatures of Rome' according to A. Gellius' well-known formula,³¹ the Roman origin myth was borrowed and transferred naturally, without any need for a special exegesis. In all these communities, Rome was referred to on coins through the use of the classic image of the she-wolf and the twins. However, because of their diverse histories, not all Palestinian colonies assigned the same role to the myth.

In Caesarea Maritima, for instance, coins showed the *sulcus primigenius* as a symbol of colonial status (fig. 2). Caesarea was a Greek city by foundation and its promotion as a Roman colony by Vespasian did not significantly change its ethnic composition. Its points of reference remained mainly Greek, Roman influence passing only through the presence of the *legatus Augusti* and his following.³² In Sebaste, a town that was granted colonial status in 201/202, Roman symbolism is also confined. The city's legal promotion

²⁶ Mishnah *Avodah Zarah* 1, 7; on the damnation of theatre and circus because they were devoted to idols, see Babylonian Talmud, *Avodah Zarah* 18b. Cf. Jacobs 1998.

²⁷ Moretti 1953, 206-211, n° 72 ; also 250, n° 85 (AD 221).

²⁸ Cf. e.g. Josephus, *BJ* 1, 85-106. Schürer *et al.* 1973 (vol. I), 228, about Alexander Jannaeus: 'this work of conquest ... was ... a question of ... annihilation of Greek civilisation'.

²⁹ Isaac 1998a, 31-35; John Chrysostom, *In principium indicationis* 199 (PG 59, col. 673) listing Near Eastern deities: ἐν τῇ Παλαιστίνῃ τῷ Δαγῶν εἰδωσίασαι.

³⁰ Kasher 1990, 32-48, who in my opinion relies too much on late Roman evidence to reconstruct the Hellenistic situation. For parallel developments in Asia Minor, see Heller 2006.

³¹ Gellius, *Noctes Atticae* XVI, 13, 9: *effigies parvae simulacrae populi Romani*; Grelle 1972, 140-144. The *lex coloniae Genetivae* organises the public cult in the colony. See Crawford 1996, I, ch. 64 ff, esp. 70-71 (*munus ludosue scaenicos Ioui Iunoni Mineruae*); Rüpke 2006.

³² Haensch 1997, 227-237; Eck 2007a, 79-103.



Fig. 2. Bronze coin from Caesarea Maritima with reverse showing the drawing of the boundary of the colony, with ox and cow and the *conditor* receiving a wreath from a small Nike flying towards him (after Meshorer 1985, n° 26, Septimius Severus).



Fig. 3. Bronze coin from Sebaste with reverse representing the toga-clad emperor while founding the Roman colony by *circumductio* of the plough (after Meshorer 1985, n° 118, Caracalla).

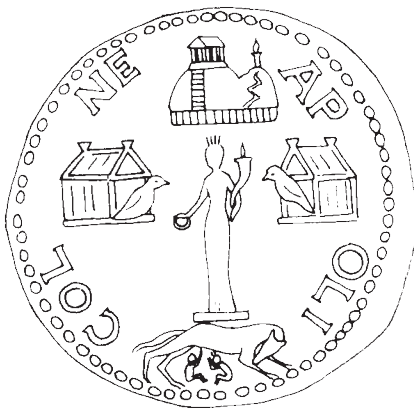

Fig. 4. Reverse of a bronze coin from Neapolis showing the civic Tyche, standing on the she-wolf suckling the twins, between two cages shaped in the manner of temples on either side, and topped by Mount Gerizim with its temple (after Meshorer 1985, n° 148, Trebonianus Gallus). Its composite construction reveals the city's diverse cultural references.

is celebrated in foundation coinage minted under Caracalla, which figures the *circumductio* (fig. 3).³³ This is one of two coin issues of truly Roman inspiration, with the Capitoline triad standing in a tetrastyle temple.³⁴ But here also, tradition remained Greek, as expressed by the name of the city, *Sebaste*, derived from the Greek equivalent of *Augusta*. Next, in neighbouring Neapolis, the Roman myth was only used to give iconographic expression to the collectivity's legal status. From the composite reverse of a coin minted under Trebonianus Gallus (fig. 4), we can infer that the religious atmosphere in this Flavian 'new city' was mainly Graeco-Semitic. The city honoured its recent (Philip I) status as a Roman colony by representing the she-wolf suckling the twins. This motif forms the basis of the whole composition: in the centre, a Tyche, holding a phial and the horn of plenty, rests her feet on the she-wolf, a position that designates her as a figure equivalent to *Genius/Iuno civitatis*. Flanking this civic divinity are two cages shaped in the

³³ Meshorer 1985, 45, n° 118; *BMC Pal.* n° 14.

³⁴ *BMC Pal.* n° 12 (Septimius Severus), and n° 15 (Julia

Maesa); Crowfoot/Crowfoot/Kenyon 1954, 67, n° 17 and 68, n° 20.



Fig. 5. Silver medallion from Neapolis with a very realistic representation of Mount Gerizim with its two eminences, an ascending flight of steps with eight chapels on either side leading to the temple on top of the central peak (after Meshorer 1985, n° 126, Antoninus Pius).

manner of Graeco-Roman temples with pediments housing doves, the birds of the Dea Syria. The true *patronus* of the whole construct is Mount Gerizim, depicted in a very realistic fashion: dominating the town, with a portico at the bottom and two eminences (cf. fig. 5).³⁵ The three cultural points of reference of the city are represented on this coin, but their respective positions paint a clear hierarchy that maintains the Graeco-Semitic tradition of *Neapolis*. The new, Roman status of the city is expressed by the she-wolf, but in an almost anecdotal fashion. It is a fact that, with the *Constitutio Antoniniana* from AD 212 onwards, colonial promotion did not lead to status changes for persons. The Gerizim and its temple remained the local reference *par excellence*: Zeus's eagle bears its shrine on his outspread wings, and two Victories carry it in a crown (fig. 6).³⁶ Even the she-wolf suckling the twins is protected by the eminence of the mount, and the Forum's Marsyas, another colonial symbol, can be found together with a Victory or an eagle with Gerizim.³⁷ If we turn finally to Scythopolis, we know, thanks to a bilingual dedication in honour of the emperor Galerius,³⁸ that this city was upgraded to colonial status. Unfortunately, there is no foundation coinage, because the honour probably dates from the Tetrarchy, when cities no longer minted coins. Had such a coinage existed, it would probably have shown the she-wolf, as in Caesarea, Sebaste or Neapolis, and this despite the fact that Scythopolis claimed Dionysos as its founder, as we shall see.

In all these colonies, we can infer that the reference to the Roman foundation myth was no more than a simple expression of their political status. Things were different in the colony of Aelia Capitolina (Jerusalem), where the Roman myth was part of the construction of civic identity, for reasons related to the specific conditions of its creation. The colony's intended character was proclaimed by its new name: *Aelia* honoured its imperial founder with its patronymic,³⁹ and *Capitolina* ensured the new community the protection of Jupiter, which Hadrian had spread in the East, albeit in the form of Zeus Olympios.⁴⁰ The revolts of AD 66-73 and 132-136, which left the civic landscape of Jerusalem a *tabula rasa*, facilitated the

³⁵ On the northern one stood the temple of Zeus Olympios, connected to the town by a large flight of steps. *BMC Pal.* n° 159 with pl. VII, 18 and Meshorer 1985, 52, n° 148. For a Samaritan explanation of the coin type, see Meshorer 1989b, 173-174, n° 1.

³⁶ Meshorer 1985, n° 140.

³⁷ *BMC Pal.* n° 118-121 (Philip I) and n° 132 (Philip I and Junior); Meshorer 1985, 51, n° 141.

³⁸ *AE* 1993, 1618 = *SEG* 20 (1964), 455; Laniado *et al.*

1993, (with bibliography and photo); Di Segni 1997b, 384-387, n° 99.

³⁹ Eusebius, *HE* IV, 6, 4: 'The Roman city which arose afterwards, changed its name and was called *Aelia* in honour of the reigning emperor Aelius Hadrianus'; cf. also *Chronicon Pascale* 119 (*PG* 92, 613) and Malalas XI (Dindorf, 279).

⁴⁰ The wording was not completely unique since a *Capitolias* had been founded in the Decapolis in 97/98. *RE* III (1899), *s.v.* *Capitolias*, col. 1529 (Benzinger).



Fig. 6. Silver tetradrachm from Neapolis with reverse depicting Zeus's eagle embracing the Gerizim temple in its outspread wings (after Meshorer 1985, n° 135, Caracalla).

establishment of an imported, not to mention implanted, settlement. This was done according to secular rules: the Etrusco-Roman ritual. The ritual of the *circumductio* gave the colony its religious limits: drawn by two oxen, the plough was driven by the founding magistrate acting with the assistance of priests. Roman religious and historiographical tradition, the latter illustrated by Plutarch's *Life of Romulus*, stated that this ritual re-enacted the foundation scene on the bank of the Tiber.⁴¹ This was all the more true in this case, since the ritual was performed under the personal auspices of the emperor himself as *conditor*. The event was immortalised on coins with a toga-clad Hadrian holding the yoke (fig. 7).⁴² Throughout the period of the city's mint, which was active from Hadrian to Herennius and Hostilian, bronze coin issues celebrated the foundation *ex nihilo* in 130/135, as well as later changes to the colony's status, using the same canonical type.⁴³ On the Hadrianic coin, which remained the standard, the *vexillum*⁴⁴ engraved behind the *conditor* expresses the fundamental link between the colonial foundation and the legionary camp that preceded it. This link was to figure on all foundation coins. For Aelia, the myth of the twins was not merely a form of political language: it was part of the demonstrative Romanness of the new colony, dominated by the Golgotha where a Capitol was built, next to the forum.⁴⁵ Gradually, from the period of the Severans onwards, the colony took on a more Graeco-oriental aspect; the Severan military reforms, when allowing legionaries to found legal families, certainly played a role in this evolution.

5 THE CREATION OF A GREEK FOUNDATION MYTH IN SCYTHOPOLIS

Scythopolis, on the west bank of the river Jordan and formerly belonging to the Pompeyan Decapolis,⁴⁶ was a Greek city which had been re-founded by Antiochos IV as Nysa, the name of a Seleucid princess. It had first been settled by the Scythians when they invaded Persian Palestine in the 7th century, and this may account for its name, 'the city of Scythians', which appears in *Judith* (3, 10) and later on in Polybius and the *Book of Maccabees*.⁴⁷ Expressions of Semitic or Nabataean culture were occasional or superficial in Scythopolis, and there were almost no monotheists in the city between the massacre of its Jewish population in AD 66⁴⁸ and the 3rd century.

⁴¹ Plutarch, *Romulus* 11.

⁴² Meshorer 1989a, n° 2.

⁴³ Under Marcus Aurelius, there was a new allotment for colonists (Meshorer 1989a, n° 42); under Septimius Severus, *in itinere Palaestinis, plurima iura fundavit* (*SHA Sev.* 17, 1); under Elagabalus, Aelia received a new eponymous epithet, *Aurelia Antoniniana* or *Aurelia Augusta* (Meshorer 1989a, n° 112); finally, in 251 under Hostilianus (Meshorer 1989a, n° 178), there was another privilege, unknown to

us because the mint was closed in 235 and only reopened under Decius. Roman and Talmudic books gave opposite meanings to this type, for which, see Stern 1998, 242-245.

⁴⁴ Rostovtzeff 1942.

⁴⁵ Belayche 1997.

⁴⁶ Isaac 1981; Bowsher 1992; Millar 1993, 408-414.

⁴⁷ Lifshitz 1977, 262-268.

⁴⁸ According to Josephus (*BJ* 2, 468), 13,000 were killed.



Fig. 7. Bronze coin from *Aelia Capitolina* celebrating the foundation of the Roman colony by the emperor Hadrian himself, holding the yoke. The standard (*vexillum*) on the back expresses the constituent link between the colonial foundation and the legionary camp which preceded it. Above to right *COL(onia) AEL(ia) KAPIT(olina)* and in exergue *COND(ita)* (cf. Meshorer 1989a, n° 2).

At the foot of the ancestral tell, the Roman city had all the features and facilities of a particularly sumptuous Graeco-Roman settlement in contact with the Graeco-Asiatic world.⁴⁹ Its lifestyle was able to rival that of the most opulent Greek cities in Asia.⁵⁰ The image Scythopolis presented of itself was never a Roman one, in spite of the reference in the Talmud to *Saturnalia* celebrated there;⁵¹ the tradition of the future capital of the Palaestina Secunda was Greek. Zeus Olympios and the Saviour gods (the Dioscuri) had been venerated there since the times of Demetrius II Nicator in the 2nd century BC.⁵² The worship of Zeus Olympios was replaced on the acropolis by that of Zeus Akraios, an epithet known to the Greek world for a mountain Zeus, and which was akin to the adoration of the gods of the heights in the Syro-Phoenician world.⁵³ This ‘Zeus of the heights’ was still honoured in Roman times.⁵⁴

Despite his dominant position, Zeus was not the city’s main god. Legend had it that the town had been the birth or burial place of Nysa, Dionysos’ wet nurse. In the 1st century, Pliny the Elder knew the legend which combined the explanation of the two names of the city: ‘Scythopolis, formerly Nysa, where Liber Pater (= Bacchus) settled the Scythians after having buried his nurse there’.⁵⁵ This tradition continued in the 2nd century with Solinus, but curiously, Nonnos’ *Dionysiaca* do not mention the legend of the nurse.⁵⁶ In the 6th century AD, in his *Chronographia*, John Malalas gave a new version of the story, connecting it even more closely to the most glorious Greek mythology. He related how Orestes and Pylades had come to Palestine with Iphigenia whom they had freed from the Scythian king Thoas; impressed by the young girl, the inhabitants built a temple to her goddess, Artemis, and asked Iphigenia to offer to the deity a young girl named Nysa.⁵⁷ Malalas is notorious for his mythographical reconstructions, and although I shall not discuss the origin of this late story, I would like to emphasise that the Byzantine writer also attempted to establish a connection between the two names and to integrate them into the oldest tradition, the Homeric one.

From the time of Gabinius in the mid-1st century BC, Dionysos appears in a public context. One century later, he is depicted on Claudian coinage.⁵⁸ However, the name of Nysa did not become common until the 2nd century. It then stood for the cultural self-assertion by a city stressing its divine origin at a time when Palestine was being progressively normalised. It marked the shift from the conception of a Scythian foundation, which – judging from the rare presence of Artemis in either official documents or the local pantheon – was never much exploited, to a more glorious Dionysian origin. In front of Dionysos’ temple, an honorific inscription on the base of a statue of Marcus Aurelius dedicated on the

⁴⁹ It was divided into *amphodoi*. Fitzgerald 1927; Applebaum 1989, 1-8; Lifshitz 1977, 270-271.

⁵⁰ Two Thasos marble statues, probably imported from Aphrodisias in the 2nd century, represent a helmeted Athena and Aphrodite. Vitto 1991.

⁵¹ Jerusalem Talmud, *Avodah Zarah* 1, 2 (39c); Lifshitz 1977, 276; Goodman 1983, 48.

⁵² Ovadiah 1975; Rigsby 1980; Fuks 1983, 81.

⁵³ Cook 1925, 871; Lifshitz 1977, 15; Tsafirir 1989; Briquel Chatonnet 2005.

⁵⁴ Lifshitz 1961, 186-190, n° 1 = Di Segni 1997b, 379-380, n° 96.

⁵⁵ Pliny, *NHV*, 74: *Scythopolim, antea Nysam, a Libero Patre sepulta nutrice ibi Scythis deductis*.

⁵⁶ Chuvin 1991a.

⁵⁷ Flusser 1974, 1066-1067.

⁵⁸ Spijkerman/Piccirillo 1978, 188, n° 2.

occasion of his visit in 175 exalted the city's titles: 'the city of the Nysaeans, also called Scythopolitans (Νυσσαέων τῶν καὶ Σκυθοπολιτῶν)'.⁵⁹ This tradition thus gave Dionysos an eminent position within the civic, religious organisation of Scythopolis.

Many coin types depict a Greek Dionysos, naked, with oinochoe, thyrsus, grapes, and panther, or standing on a chariot.⁶⁰ During the Hadrianic period, the god was also represented as a member of a triad, with Tyche and Zeus, from whose thigh the body of a child emerges.⁶¹ Some types show him in association with Tyche only, as on a Gordian III coin where a *kourotrophos* Tyche is depicted as a sitting Nysa suckling the divine child.⁶² An inscribed hexagonal limestone altar dated to AD 141/142 tells the foundation myth in the most public context (fig. 8). The altar, decorated with masks of Dionysos, Pan and Silenus, and adorned with Dionysiac attributes (thyrsus, panpipes and crook), was erected in front of the basilica's apse. Its location cannot have been fortuitous, since basilicas were the public buildings to which *curiae* were usually linked.⁶³ The location, the donor, and the epigraph, all suggest an official offering. The altar was dedicated by Seleukos, son of Ariston, according to a traditional votive formula: Ἀγαθῇ τύχῃ. Θεῷ Διονύσω (to the god Dionysos), κτίστη τῷ κυρίῳ (founding master), Σέλευκος Ἀριστωνος, χαριστήριον (in recognition).⁶⁴ The dedicator, of Hellenised, Seleucid origin, seems to have belonged to the city's ruling aristocracy (*aristoi*).⁶⁵ A shorter epigraph, Θεῷ Διονύσω Γερμανός,⁶⁶ confirms the interest in the god from a dedicant whose name occurs many times in the Near East. In addition to the altars, there must have been a temple of Dionysos in Scythopolis; this was probably the prostyle temple which had a *naos* with a circular apse.⁶⁷ It was located in the heart of the town, at the intersection of the two main streets,⁶⁸ and opened onto a paved square where the monumental base offered to Marcus Aurelius⁶⁹ was situated, which was perhaps intended for a statue of the god. A young Dionysos, crowned with a vine branch and ivy, and a monumental head, have been found in the portico built during the Byzantine period. Fragments of a frieze adorned with Dionysos' head may have been part of the temple's decoration.⁷⁰

The Scythopolitan dedication is the only known Palestinian inscription honouring a founder god, although several other cities, mainly on the coast, also claim such a glorious foundation. L. Di Segni explains this lack of evidence by a deliberate refusal to use the word *ktistès* – the Creator's name in the Septuagint – in a country 'strongly imbued with Jewish, Christian and pagan-monotheistic beliefs'.⁷¹ However, during the Roman period, cities claiming a divine founder did not in fact come under strong monotheistic influences. In addition, Graeco-Roman populations had not read the Greek version of the Bible, at least until the development of an anti-Christian polemic in the 2nd century AD, which did not reach Palestine at that time. In the same paper, L. Di Segni provides a detailed analysis of the meaning

⁵⁹ Foerster/Tsafirir 1986/1987 = Di Segni 1997b, 382–384.

⁶⁰ *BMC Pal.* n° 12–13 (Gordian); Spijkerman/Piccirillo 1978, 187; Meshorer 1985, n° 105 (Antoninus Pius), n° 107 (Commodus), n° 109 (Geta).

⁶¹ *BMC Pal.* n° 11; Meshorer 1985, n° 112 (Gordian III).

⁶² *BMC Pal.* n° 6–10; Meshorer 1985, n° 110. *LIMC* III, 1 (1986), s.v. Dionysos in *Peripheria Orientali*, 523 (Augé/Linant de Bellefonds).

⁶³ Balty 1991.

⁶⁴ Di Segni/Foerster/Tsafirir 1996 = Di Segni 1997b, 381–382, n° 97.

⁶⁵ Di Segni 1997a, 140–143. It is doubtful that a link existed with the mid-3rd century Seleukos (*ibid.*, 143 n. 12) who

dedicated the inscription to Ares Hoplophoros and who was obviously a soldier or an official in transit. Three other inscriptions (two of them dating from 235/240) dedicated by a Seleukos, son of Ariston, are mentioned by Foerster and Tsafirir (1993, 8) but not published. They must have come from the basilica area where they were reused.

⁶⁶ Lifshitz 1970, 62, n° 3 with pl. a; Ovadia 1975, 122, n° 6.

⁶⁷ On the basis of the circular shape, Foerster/Tsafirir (1990, 31–32) surmise that it could have been a *herōon* dedicated to Nysa.

⁶⁸ *NEAEHL* 1, 'Beth-Shean', 227 (Foerster).

⁶⁹ *Supra*, note 59.

⁷⁰ Foerster 2000.

⁷¹ Di Segni 1997a.



Fig. 8. Limestone hexagonal altar from Scythopolis for the god Dionysos, whose mask is carved above an inscription written in a *tabula ansata* honouring him as the ‘founding master’ (after Foerster/Tsafirir 2002, 77, fig. 110–111). With its prominent place in front of the local basilica, the inscribed altar, dedicated by Seleukos, son of Ariston, most probably a member of the city’s ruling aristocracy, proclaims the city’s foundation myth.

of the founder’s cult, with Hadrian represented as a human archetype. She lists parallels from Asia Minor and the Balkans and relates them to the emphasis placed on origins, which was characteristic of the 2nd century and which reflected the Panhellenism to which Hadrian gave such a strong impetus.⁷² In Scythopolis, two monumental cuirassed statues testify to his impact in the area. A bronze statue of Hadrian found at Tell Shalem near the city is one of two pointers to the city’s sympathies with Romanness.⁷³ It was closely linked to the encampment of the *legio VI* during the Second Revolt, and strongly recalls the torso of a marble statue found in the urban excavations, with a breastplate decoration showing an apotropaic Medusa’s head above two griffins and an eagle perched on a thunderbolt. The dedication of the public altar to Dionysos is slightly later in date, from the reign of Antoninus Pius, when the last vestiges of agitation following the Bar Kokhba war were finally stamped out.

Since Dionysian aetiology does not appear in the city’s propaganda before the imperial period, it is impossible to date this devotion back to the Ptolemies, who venerated Dionysos as their ἀρχέτης⁷⁴ and who raised tribute to Scythopolis until 218 BC. Nor can we invoke the assimilation between Yahveh and

⁷² Pont 2007.

⁷³ Foerster 1980 and 1985; Gergel 1991.

⁷⁴ *RE* II (1895), s.v. *Archègetès*, col. 442–443 (H. Jessen), and Leschhorn 1984.



Fig. 9. Bronze coin from Ascalon with reverse showing Poseidon standing with his right leg on a rock, his left hand holding the trident, and a dolphin above his right hand; AD 158-159 (cf. Rosenberger 1975, n° 189). Source: http://www.wildwinds.com/coins/ric/marcus_aurelius/_ascalon_AE26_Rosenberger_189.jpg.

Dionysos, of which traces are to be found in some 2nd-century BC speculations.⁷⁵ On the other hand, its expression fits perfectly well with the claim for Hellenism which the city repeated on its coin legends⁷⁶ as well as on the above-mentioned dedication to Marcus Aurelius: 'holy and inviolable, among Greek cities of Coele Syria'.⁷⁷ The rare final formula *Hellenis polis*⁷⁸ suits the image of a city whose toponym refers to Europe.⁷⁹ It was doubly pertinent to choose Dionysos as a founder, since the god linked the city to the most triumphal of Greek traditions, providing it, at the same time, with the means to assert its loyalty to the empire. In fact, when the Nysaeen tradition developed, under the Antonines, emperors were worshipped as Νέοι Διόνυσσοι.⁸⁰ Independently from any imperial reference, the period saw the widespread iconographic diffusion of the Dionysian myth. For instance, the triumph of Dionysos provided a popular motif for luxurious mosaic pavements. Palestine was also geographically well situated for the use of this theme, since the young victorious god was known to have crossed the region on his journey back from India; therefore his passage through Scythopolis was not inconceivable. Even in the Galilaean city of Sepphoris-Diocaesarea, where the majority of the population was Jewish, this theme was favoured. The earthquake of 363 preserved the Dionysiac pavement of a sumptuous building. The *triclinium* mosaic displays the mythological story of the god ΒΑΧΧΕ and depicts Bacchic rites; its central panel shows the two victorious gods, Dionysos and Heracles, feasting. The choice of Dionysos' adventure, with its mythical and ritual features, was not accidental. The villa was probably connected to the neighbouring theatre and must have housed the actors invited by the city. The iconographic theme conformed to the main trends of the Greek world's religiosity in the 2nd-3rd centuries, a period when Dionysos had become the symbol of hope for survival.⁸¹

In Scythopolis, the ideological construct, publicly endorsed by the ruling class, sheds light on the culture of the local society. In the extreme south of Palestine, on the border with Egypt, the city of Raphia also claimed a Dionysian patronage, but in a more contrived way. Despite the scanty information available on this city, one may safely assume that in this case the connection was established purely on an etymological basis. The town's name evoked the stitching, ραφή, that Zeus put into his thigh in order to bring Semele's child to term. This may explain why the local coinage features either the child held by the civic Tyche or the young god, naked, holding the thyrsus and accompanied by a triumphal panther as

⁷⁵ Under Antiochos Epiphanes, Dionysia were celebrated in Jerusalem: *II Maccabees* 6, 7; Kern 1923-1924. Flussner 1974, 1068-1069 'surmises' that the link between Dionysos and Beth Shean would have come from good relationships between Jews and pagans and from the assimilation of Yahveh with Dionysos.

⁷⁶ Gitler 1990-1991.

⁷⁷ τῆς ἱερᾶς καὶ ἀσύλου τῶν κατὰ Κοίλην Συρίαν Ἑλληνίδων πόλεων. Cf *supra*, note 69.

⁷⁸ Cohen 2006, 290-299.

⁷⁹ Sartre 1988; Gatier 1990, 205-206, n° 2; more generally Foerster/Tsafir 1992. We read a similar pride in Dura

Europos: Κωλονεία Εὐρωπαϊῶν Σελεύκου (Seleucus Nicator). Welles/Fink/Gilliam 1959, n° 32, l. 4.

⁸⁰ Beaujeu 1955, 172 and 307-311; Pleket 1965. Dionysos also appears in Abila: Mare 1994, 370; *LIMC* III, 1 (1986), *s.v.* *Dionysos in Peripharia Orientali*, 406-419 (Augé).

⁸¹ Jeanmaire 1970, 372-416. For the fashion of Dionysiac representations on sarcophagi, e.g. on the Neapolis road to the north of Jerusalem, see Michon 1913. In Erez (near Ascalon), on a 5th-century mosaic pavement, Dionysos' triumphal procession has been adapted to Christian conceptions. See Rahmani 1975 and Daszewski 1985.

in Scythopolis.⁸² In the Decapolis, another city also played on etymology in order to link itself to some glorious origin. On the coinage of Hippos-Susita, founded by the Seleucids (Antiochia ad Hippum),⁸³ the city's name is spelled out by an emblematic horse: coins feature either a horse's head, or Tyche, holding a horse by the bridle or carrying a little horse on her right hand.⁸⁴ Aetiology was clearly at work here, turning a trivial horse into a Pegasus by reference to Greek mythology.⁸⁵

6 A SYRIAN FOUNDATION MYTH IN ASCALON

In Ascalon, Greek tradition is also evident in the legend which attributed the foundation to Ascalos, son of Poseidon (fig. 9).⁸⁶ This, however, was never the main tradition. The Philistine town, which passed into Tyre's control during the Persian period,⁸⁷ was known above all for the temple of its *thea patria* Atargatis-Derketo, Aphrodite Urania in Greek.⁸⁸ As early as the 5th century BC, Herodotus knew of this as 'the oldest of all the temples of the goddess'.⁸⁹ On his way to Jerusalem, Philo of Alexandria would have noticed how popular the local tradition was. 'In Syria, by the sea, is a town called Ascalon; when I passed by there ..., I saw an incredible number of doves at the crossroads and in each house'.⁹⁰ Derketo was the civic goddess to whom the foundation of the city was attributed.⁹¹ Her name is a dialectical variation of Atargatis, the Syrian goddess, probably formed in the 7th century BC; the link with Semiramis, Derketo's daughter according to mythology, went back to the times of Persian domination.⁹² On silver coins dated from the 1st century BC, the dove depicted on the reverse was used as the city's emblem, and a coin from AD 225 chose the two symbolical representations of Astarte-Tyche: the *aphlaston* (the ornament on a ship's stern) and the dove.⁹³ Clearly, in Ascalon, the foundation myth did not primarily serve a political assertion; it was the pillar of one of the two great local cults.

7 FOUNDATION MYTHS IN BICULTURAL, GRAECO-SEMITIC CITIES

Greek cities were little open to Romanisation on the linguistic level; the Latin language remained confined to the administrative and military population which settled there. These cities continued in their

⁸² *BMC Pal.*, LXXXII and n° 3 (Septimius Severus) and 6 (Elagabalus); Meshorer 1985, n° 71 (Commodus).

⁸³ Roman coinage emphasises this origin with the legend 'Antiocheans of the city of Hippos, holy, asylum'. Meshorer 1985, n° 199 (Lucius Verus).

⁸⁴ Meshorer 1985, n° 203 (Antoninus Pius); Rosenberger 1990-1991, 79, n° 6 (Elagabalus); Meshorer 1985, n° 202 (Lucius Verus); but no evidence allows us to say that 'such a statue stood in a temple of Tyche in the city', *ibid.*, 75.

⁸⁵ Meshorer 1985, n° 200 and 204 (Faustina Junior and Elagabalus); *RPC* II, 2102.

⁸⁶ Nicolas Dam. fr. 26 (Müller, *FHG* III, 372).

⁸⁷ Schürer *et al.* 1979 (vol. II), 105-108.

⁸⁸ *IDélos* 2305: Ἀστάρτη Παλαιστίνη Ἀφροδίτη Οὐρανία; cf. also 1719; Baslez 1977, 81. Cf. Herodian, 5, 6, 4. Roscher, *Lexicon* I, 1, *s.v.* Aphrodite (Roscher), 390-395 ('Die

orientalische Aphrodite'). In Gerasa, a *thea Ourania* is known: Welles 1938, n° 24-26.

⁸⁹ Herodotus, I, 105; Pausanias, I, 14, 7; Roscher, *Lexicon* I 1, *s.v.* Aphrodite (Roscher), 390-406.

⁹⁰ *Ap.* Eusebius, *PE* VIII, 64. Cf. Tibullus, *Elegies* I, 7, 18 : 'the white dove that the Syrians of Palestine revere' (*Alba Palaestino sancta columba Syro*).

⁹¹ For her mythology, see Diodorus Sic. 2, 4. Cf. Oden 1977, 69-72. For a latter, euhemeristic version of the myth, see *CCDS* 1. II, 97 ff.

⁹² *CCDS* 1. II, 15-20. Lucian, *Dea Syria* 14, distinguishes Derketo of Ascalon and the goddess of Hierapolis (Atargatis) honoured in human form.

⁹³ Meshorer 1985, n° 42. Cf. Lucian, *Dea Syria* 14; Cumont 1929, 108 and 255 (note); *LIMC* III, 1 (1986), *s.v.* Dea Syria, 355-358 (Drijvers).

Greek ways, which had been successfully grafted onto Semitic traditions. The use of Greek channels benefited local traditions relating to divine or mythical founders and to supernatural patrons.⁹⁴ According to Claudius Iolau, Dora, the ancient Tanturah,⁹⁵ had been settled by the Phoenicians (Φοινίκων αὐτὴν οἰκούντων). And yet it displayed its status as a Greek city ‘sacred, inviolable autonomous, (Δωριπῶν ἱερὰ ἄσυλος αὐτονομος)’.⁹⁶ Playing with etymology in a rather imaginative way, it claimed a mythical Greek founder, Doros, son of Poseidon. The two figures inspired the motif struck on the reverse of local bronze coins, as well as the representation in a temple of Zeus and Astarte-Aphrodite-Tyche, or that of the deity holding a marine ensign, an appropriate symbol for a city which called itself ναυαρχίς (‘flagship’).⁹⁷

Further to the south, in Jaffa (Ἰόπη, Ἰόππη), the coinage only depicted the legend that linked the city to Greek mythological tradition, despite having acquired the title of *Flavia* in the reign of Vespasian. The Greeks associated the city with the myth of Perseus and Andromeda, which went back to the most ancient times of Palestine, since its foundation was reputed to be *antiquior terrarum inundatione*.⁹⁸ A spring of red water near Jaffa kept alive the memory of the Greek hero who, ‘after having killed the sea-monster, to which the daughter of Cepheus had been exposed, washed off the blood in the spring’.⁹⁹ The bones of the monster had been displayed in Rome itself during a triumph in 58 BC,¹⁰⁰ and according to Flavius Josephus, ‘the impressions of Andromeda’s chains’ could still be seen on the sea rocks.¹⁰¹ This myth was the main – and almost exclusive – inspiration for local coinage in the Severan period: Perseus holding the harpoon and Medusa’s head, the bull offered as a thanksgiving sacrifice to the gods, and Athena – the protective goddess of the hero – who remained alone on coinage after Elagabalus.¹⁰² With the progress of Christianisation, this mythological episode, recorded on civic coins in the shape of a rider besieging a monster with his lance,¹⁰³ may have endured in the representation of St. George, martyred under Diocletian and buried in Lydda-Diospolis. Jaffa thus expressed its glorious birth in two forms, one linked to the most ancient near-eastern traditions (the Flood) and another one dependent on Greek tradition. But unlike Scythopolis, the evidence does not allow us to see whether the foundation myth went further than a mediatic image, and no founder cult is attested in Jaffa.

The elaboration of Gaza’s origins was more complex and contrived. The great local god was Marnas, ‘Lord of the rains’.¹⁰⁴ Sometimes represented on coins by the Phoenician letter *mem*, which had become the mint’s trademark,¹⁰⁵ Marnas was the only god sufficiently representative of the local identity to be transported to Transjordan and even as far as Ostia by emigrants from Gaza.¹⁰⁶ His image as a great pagan god is nearly as paradigmatic as that of Serapis in Alexandria, whom he survived by ten years.¹⁰⁷ He was so much

⁹⁴ For the Hellenistic period, see Geiger 1990.

⁹⁵ Pliny, *NHV*, 17. For a general presentation, see *NEAEHL* 1, ‘Dor’, 357–368 (Stern).

⁹⁶ Claudius Iolau *ap.* Steph. Byz., *s.v.* Δῶρος (Müller, *FHG* IV, 363).

⁹⁷ Meshorer 1986–1987.

⁹⁸ Pliny, *NHV*, 69; Ammianus 22, 15, 24. Hill 1914, XXIV; Flusser 1974, 1080–1083. For Sartre 2002, this case betrays ‘une géographie ‘syrienne’ de la mythologie grecque’.

⁹⁹ Pausanias IV, 35, 9 [*GLAJJ* II, n° 354]; already in Pseudo-Scylax, *Periple* 104; Strabo XVI, 2, 28; Pliny, *NHV*, 128. Grimal 1988⁹, *s.v.* Andromède, 36, and *LIMC* I, 1 (1981) *s.v.* Andromeda, 774–790 (Schauenburg).

¹⁰⁰ Pliny, *NH* IX, 11 [*GLAJJ* I, n° 209].

¹⁰¹ Josephus, *BJ* 3, 420.

¹⁰² Meshorer 1985, n° 35–38. In Syria-Phoenicia, Ptolemais

coinage also depicts Perseus’ harpe, as well as the thunderbolt of Zeus and of the great Semitic god of storms, from Caracalla’s time on; cf. *RPC* I, 4748.

¹⁰³ Meshorer 1985, n° 39 (Caracalla).

¹⁰⁴ Roscher, *Lexicon* II, 2 (1895/1897), *s.v.* Marnas, 2377–2382 (Drexler); Cook 1940, 552–558; *RAC* VIII (1972), *s.v.* Gaza, 1124–1125 (Downey).

¹⁰⁵ Damascius, *In Parmenidem*, 262 (Ruelle, vol. II, 127–128): ‘among the Egyptians, the sign called tet, which is formed by a vertical line and three horizontal ones ... , in the same way another sign among the Heliopolis people and among the Gaza people a third one for Zeus (παρὰ Γαζαίοις ἄλλο τοῦ Διός)’. Mussies 1990, 2424–2425.

¹⁰⁶ *IGLS* 2412g (Διὶ Μάρνα τῷ Κυρίῳ); for the Marneion of Ostia in Aramaic, *CIS* I, 16.

¹⁰⁷ Jerome, *Epist.* 107, 2.

the face of the city that, during the Christians' attack in 402, a crisis arose among the Christians themselves, with a minority wanting to keep the temple intact by converting it into a church.¹⁰⁸ Marnas' reputation of being honoured by human sacrifices,¹⁰⁹ despite the lack of proof during the Roman period, calls to mind the cultic practices for the Philistine god Dagon, honoured in Azotus before the time of Jonathan Maccabee.¹¹⁰ The literary tradition unanimously identifies Marnas with the Cretan Zeus interpreted as meaning 'born in Crete' (ἐρμηνευόμενον Κρηταγενῆ).¹¹¹ In spite of a name which is probably Semitic ('Our Lord'),¹¹² Stephanus Byzantinus says that *Marnas/Marnan* is a Cretan name meaning Παρθένος. 'But some people tell of a legend according to which it [Gaza] was founded by Zeus who left his treasure there, for Gaza is the Persian word for silver.¹¹³ It was also called Minoa because Minos, with his brothers Eachus and Rhadamantus, leaving his country, founded this city'.¹¹⁴ The connection between Crete and Phoenicia is attested to from the earliest times.¹¹⁵ Without going back as far as the arrival of the Peoples of the Sea, Gaza and its port maintained regular links with the Greek island. Nevertheless, in the light of other Palestinian traditions, I prefer to follow the conclusions of G. Mussies, who considers 'the Cretan origin of this enigmatic deity as a later addition due to the – mainly Hellenistic – tendency to elaborate the historical fact of the stay of the Philistines in Crete'.¹¹⁶ As far as historical evidence is concerned, the aetiology of the Cretan Zeus is confirmed by the legend on a coin from Hadrian's time, which bears the name MINOS, the legendary king of Knossos,¹¹⁷ and by the toponymy: a village situated to the south-east of Gaza is called *Minois*.

Etymologies for Marnas seem to have developed in a more or less coherent fashion. They highlight the value which the citizens of Gaza and the literary tradition attached to a Greek ascendance. Flavius Josephus stressed this connection to explain why, on Herod's death, Gaza, like Gadara and Hippos, had been integrated in the province of Syria.¹¹⁸ We see the city proudly boasting its Greek titles on a dedication made in Ostia in 243 on the god's order and through the temple's curator: ἡ πόλις ἡ τῶν Γαζαίων ἱερά καὶ ἄσυλος καὶ αὐτόνομος πιστὴ καὶ εὐσεβὴς λαμπρὰ καὶ μεγάλη ('the city of the Gazaeans, holy, asylum, autonomous, faithful, pious, illustrious and great').¹¹⁹ The dedication shows the same noble series of titles as the other Greek cities in Asia Minor, Syria and Palestine. Overall, the nomenclature of notables was Graeco-Roman,¹²⁰ even though some names were of Egyptian origin.¹²¹

On coins, the depiction of Marnas varies, reflecting the more or less Hellenic aspect of his personality and cult. When he is represented, for instance on a Gordian III coin, standing naked, his right hand raised and his left hand brandishing the thunderbolt, it is his Jovian aspect that is being emphasised. This is enhanced by the depiction of an eagle at his feet and of a Nike who is crowning him.¹²² However, the Marnas of

¹⁰⁸ Mark Deacon, *Vita Porphyrii* 66, 3–4.

¹⁰⁹ Mark Deacon, *Vita Porphyrii* 66, 12–13.

¹¹⁰ *I Maccabees* 10, 83–84; *RAC* I (1950), *s.v.* Baal, Dagon, 1086 (Klauser).

¹¹¹ Stephanus Byzantinus *s.v.* Γάζα; Mark Deacon, *Vita Porphyrii* 64, 18. Cf. also Epiphanius of Salamis, *Anchoratus* 109C (*PG* 43, 209). Mussies 1990, 2427–2433, has collected the mythological sources. On the Cretan Zeus as a juvenile god, see Capdeville 1995, 179–196.

¹¹² *RE* XIV, 2 (1930), *s.v.* Marna, Marnas, col. 1899–1906 (Preisendanz). Cf. Philo, *Legatio ad Gaium* 39, on a demonstration in Alexandria against Agrippa qualified as 'Marin'. After etymological research, Mussies 1990, 2433–2443, concludes that it is a Philistine name, and not an Aramaic one.

¹¹³ Cf. also Epiphanius, *Panarion* 30, 6, 7: 'gaza means 'treas-

ure' in Hebrew'.

¹¹⁴ Stephanus Byzantinus, *s.v.* Γάζα.

¹¹⁵ Mussies 1990, 2443–2447.

¹¹⁶ Mussies 1990, 2446. *Contra* Chuvin 1991b, 210, who believes in the Philistine tradition, as in Tyre for Heracles Melqart.

¹¹⁷ Meshorer 1985, 29, n° 55. According to Stephanus Byzantinus, the city had first been called Minoa. Thus, Cook 1914, I, 478, proposed a labyrinthic plan for the Marnas temple.

¹¹⁸ *BJ* 2, 97. Schürer *et al.* 1979, II, 98–103.

¹¹⁹ *IG* XIV, 926, lines 7–11.

¹²⁰ Di Segni 1997b, 541–557, n° 177*–191*.

¹²¹ Di Segni 1997b, 510–511, n° 153: a 179/180 dedication of Ammonios, son of Domesticos.

¹²² *BMC Pal.* n° 147; Meshorer 1985, n° 65.



Fig. 10. Bronze coin from Gaza (AD 131/132) with reverse displaying a distyle temple enclosing two figures: to the right, Marnas in the form of a young, Apollo-like god, naked, holding a bow and facing his female consort (an Artemis?) in her huntress form, drawing arrow from quiver at her shoulder and holding a bow (after Rosenberger 1977, n° 65).

Gaza could also resemble Idumaeen Qos as featured in Khirbet et-Tannur.¹²³ Other, more numerous series of coins depict him in a temple with a triangular pediment, in the form of a young, Apollo-like god (like Zeus Casios of Pelusa), naked, holding a bow and facing his female consort (an Artemis?) in her huntress form (fig. 10).¹²⁴ He is no longer the bearded, seated Greek-style Zeus found in the Tell el-Ajjul area.¹²⁵

A number of other city temples, which might shed some light on our enquiry, are not mentioned by Mark the Deacon, including those of Io or Artemis, and of Heracles or his son, although these deities are often summoned as divine references in aetiological legends and on coins. However, this is consistent with the ideological character of the documents where they do appear; we might conclude that they did not receive cultic honours.¹²⁶ Yet, Porphyrius' biographer lists τὸ λεγόμενον Ἡρωεῖον (the so-called *Heroeion*)¹²⁷: it is only known from this list and may have preserved the memory of Heracles and his, possibly eponymous, son.¹²⁸ From the available aetiological legends, Stephanus Byzantinus quoted the one which linked the city's name with Aza, son of Heracles, a presumed founder: 'It was called Aza, as well as Gaza, and until today Syrians call it Aza from Azon, son of Heracles'.¹²⁹ Coins often depict the bust of Heracles, or Heracles standing, holding a club and the lion's skin (fig. 11).¹³⁰ In the 5th century, his twelve labours were represented marking the hours on a large public clock described by Procopius of Gaza.¹³¹ A lead sarcophagus, perhaps made in a Gaza workshop, displays a drunken Heracles on a chariot drawn by centaurs in the style of Dionysiac-inspired motifs,¹³² the popularity of which in Palestine has already been illustrated by the Diocaesarea mosaic. The Heroon could also have been an Ioon. 'It is also called Ione for Io came all the way here, via the sea route, and landed here'.¹³³ The flight of Io pursued by Hera's ire was well known to have led Zeus' beloved, transformed into a heifer, towards the southern Mediterranean and to Egypt, so that she gave her name to the *Ionian Pelagos* between Gaza and Egypt. Her miserable fate inspired the minters, who chose to represent her either in her zoomorphic shape at the feet of the civic Tyche,¹³⁴ or in her human form, shaking the hand of the civic divinity.¹³⁵ Stephanus Byzantinus specified that 'there was a heifer near a statue'; this might indicate that a statuary group served

¹²³ Glueck 1937, 15 and fig. 8a and 8c; *IGLS XXI*, Jordanie 4, 124-125, n° 95.

¹²⁴ Meshorer 1985, n° 56 (during Hadrian's visit in 130), n° 62 (from AD 204), and n° 64 (from AD 220). Cf. Teixidor 1977, 97-98.

¹²⁵ Conder 1880.

¹²⁶ Similarly, depictions of Tyche do not always refer to cultic honours. Belayche 2003.

¹²⁷ Mark Deacon, *Vita Porphyrii* 64, 4-7.

¹²⁸ For Mussies, 1990, 2417, the Heroeion 'was the temple of either Heracles or Minos' with no further discussion.

¹²⁹ Stephanus Byzantinus *s.v.* Γάζα. Chuvin 1991b, 210, thinks that Heracles-Melqart, a possible founder god as in Tyre, could be the same as Marnas.

¹³⁰ *BMC Pal.* n° 46-55 (Hadrian), 80-87 (Antoninus Pius), 93-95 (Marcus Aurelius) etc.; Meshorer 1985, n° 59 (Antoninus Pius).

¹³¹ Abel 1931, 10.

¹³² Rahmani 1989, 72-74, n° IV with pl. 8.

¹³³ Stephanus Byzantinus *s.v.* Io; Libanios, *Orationes* 55, 32-33. Cf. Duchemin 1979, 6-23.

¹³⁴ *BMC Pal.* n° 28-45 (Hadrian); Meshorer 1985, n° 58 (Marcus Aurelius).

¹³⁵ *BMC Pal.* n° 23-27 (Hadrian); Meshorer 1985, n° 63 (Geta). Mussies 1990, 2447-2448, goes as far as to imagine that Io was Marnas' consort in his temple.



Fig. 11. Bronze coin from Gaza (AD 130/131) with reverse depicting Hercules standing facing, leaning on club and holding the lion skin; to his right the letter *mem* (cf. Rosenberger 1977, n° 51). Source: <http://http://imagedb.coinarchives.com/img/cng/078/image01494.jpg>

as a model for the engravers. Whatever the identity of the god to whom the shrine may have been dedicated, what is significant for us is that the city's ancient Philistine history was almost concealed, and the Gazaeans preferred to trace their roots back to a Greek past.

CONCLUSION

This journey through Roman Palestine has revealed many different options for the cities wishing to boost their local image by claiming a divine foundation. These claims became more prominent in the period after the two Jewish wars, when Palestine had to redefine its position within the Roman world. In this context, the points of reference invoked for the construction of civic identity could not be original, since they had to proclaim the cities' successful integration among the communities of the Graeco-Roman world. Therefore, these models of mythical or cultural claims were sought in other oriental provinces, in Asia Minor and Syria. The fact that older local traditions were still alive did not curb this trend. In the cities with a renowned Greek mythology (e.g. Ascalon), they simply had to portray its main figures, for instance on coins. With the exception of Aelia Capitolina, all the Roman colonies preferred to keep their own cultural traditions (e.g. Neapolis) instead of borrowing the Roman twin myth, however majestic it may have been. Other cities (e.g. Scythopolis or Gaza) that had to assert their image and position in the large eastern region developed an aetiology based on Greek values; these were prevalent culturally at that time and ensured that the cities could be distinguished from their Jewish neighbours. These Greek traditions that conveyed a glorious image could be grafted onto local, Philistine traditions as in Gaza, or onto a Roman tradition (e.g. Aelia Capitolina) when the Roman political masters were exporting their own model.

ABBREVIATIONS

<i>AE</i>	<i>l'Année Epigraphique</i>
<i>ARG</i>	<i>Archiv für Religionsgeschichte</i>
BEFAR	Bibliothèque des Ecoles Françaises d'Athènes et de Rome
BMC <i>Pal.</i>	Hill, G.F., 1914: <i>Catalogue of Greek Coins of Palaestina in the British Museum</i> , London.
CCDS	<i>Corpus Cultus Deae Syriae</i>
CIS	<i>Corpus Inscriptionum Semiticarum</i>
FHG	Müller, K. (ed.), 1975 (1841-1851): <i>Fragmenta Historicum Graecorum</i> , Paris (5 vols).
GLAJJ	Stern, M., 1976-1984: <i>Greek and Latin authors on Jews and Judaism</i> , Jerusalem (3 vols).
IDélos	<i>Inscriptions de Délos</i>
IG	<i>Inscriptiones Graecae</i>
IGLS	<i>Inscriptions Grecques et Latines de Syrie</i>

LIMC	<i>Lexicon Iconographicum Mythologiae Classicae</i>
NEAEHL	Stern, E. (ed.), 1993: <i>The New Encyclopedia of Archaeological Excavations in the Holy Land</i> , Jerusalem.
PG	<i>Patrologie Grecque</i>
RAC	<i>Reallexikon für Antike und Christentum</i>
RE	<i>Paulys Realencyclopädie der classischen Altertumswissenschaft</i>
REG	<i>Revue des Études Grecques</i>
REJ	<i>Revue des Études Juives</i>
RPC	<i>Roman Provincial Coinage</i>
SEG	<i>Supplementum Epigraphicum Graecum</i>

REFERENCES

- Abel F.-M., 1931: Gaza au VI^e siècle d'après le rhéteur Chorikios, *Revue biblique* 40, 5-31.
- Applebaum S./B. Isaac/Y. Landau, 1981/1982: Varia epigraphica, *Scripta classica Israelica* 6, 98-111.
- Applebaum, S., 1989: *Judaea in Hellenistic and Roman times. Historical and archaeological essays*, Leiden (Studies in Judaism in late antiquity 40).
- Balty, J.-Ch., 1991: *Curia ordinis. Recherches d'architecture et d'urbanisme antiques sur les curies provinciales du monde romain*, Bruxelles (Académie royale de Belgique, Mém. Beaux-Arts, 2nd series, XV, 2).
- Baslez, M.-F., 1977: *Recherches sur les conditions de pénétration et de diffusion des religions orientales à Délos (IIe-Ier s. avant notre ère)*, Paris.
- Beaujeu, J., 1955: *La religion romaine à l'apogée de l'Empire I. La politique religieuse des Antonins (96-192)*, Paris.
- Belayche, N., 1997: Du Mont du Temple au Golgotha. Le Capitole de la colonie d'*Aelia Capitolina*, *Revue de l'Histoire des religions* 214, 387-413.
- Belayche, N., 2001: *Iudaea-Palaestina. The pagan cults in Roman Palestine (second to fourth century)*, Tübingen (Religion der Römischen Provinzen 1).
- Belayche, N., 2003: Tychè et la Tychè dans les cités de la Palestine romaine, *Syria* 80, 111-138.
- Belayche, N., 2004: Déclin ou reconstruction ? La Palaestina romaine après la révolte de 'Bar Kokhba', *REJ* 163, 25-48.
- Bouffartigue, J., 1996: La tradition de l'éloge de la cité dans le monde grec, in C. Lepelley (ed.), *La fin de la cité antique et le début de la cité médiévale, de la fin du III^e siècle à l'avènement de Charlemagne*, Bari, 43-58.
- Bowersock, G.W., 1990: *Hellenism in Late Antiquity*, Cambridge etc.
- Bowsher, J.M.C., 1992: Civic organisation within the Decapolis, *ARAM. Society for Syro-Mesopotamian studies* 4, 265-281.
- Briquel Chatonnet, F., 2005: Les cités de la côte phénicienne et leurs sanctuaires de montagne, *ARG* 7, 20-33.
- Bruit Zaidman, L./Gherchanoc, F. (eds), 2006: Τὰ ἀρχαία dans les mondes grec et romain. Définitions et usages de la 'notion d'archaïsme', *Ktema* 31, 3-242.
- Capdeville, G., 1995: *Vulcanus. Recherches comparatistes sur les origines du culte de Vulcain*, Rome (BEFAR 288).
- Chuvin, P., 1991a: *Mythologie et géographie dionysiaques. Recherches sur le poème de Nonnos de Panopolis*, Clermont-Ferrand.
- Chuvin, P., 1991² b (1990): *Chronique des derniers païens. La disparition du paganisme dans l'Empire romain, du règne de Constantin à celui de Justinien*, Paris.
- Cohen, G.M., 2006: *The Hellenistic Settlements in Syria, the Red Sea Basin and North Africa*, Berkeley/Los Angeles/London.
- Conder, C.R., 1880: Discovery of a statue near Gaza, *Palestine exploration fund. Quarterly statement*, 7-9.

- Cook, A.B., 1925: *Zeus II*, London.
- Cook, A.B., 1940: *Zeus III.1*, London.
- Crawford, M. (ed.), 1996: *Roman statutes*, London.
- Crowfoot, J.W./G.M. Crowfoot/K.M. Kenyon, 1954: *Samaria-Sebaste. Reports of the work of the joint expedition in 1931-1933 and of the British expedition in 1935 vol. III. The objects at Samaria*, London.
- Cumont, F., 1929⁴ (1906): *Les religions orientales dans le paganisme romain*, Paris.
- Daszewski, W.A., 1985: *Dionysos der Erlöser*, Mainz.
- Dindorf, L. (ed.), 1832 : *Chronicon Pascale*, Bonn (Corpus scriptorum historiae Byzantinae 16-17).
- Di Segni, L., 1997a: A dated inscription from Beth Shean and the cult of Dionysos *Ktistes* in Roman Scythopolis, *Scripta classica Israelica* 16, 139-161.
- Di Segni, L., 1997b: *Dated Greek inscriptions from Palestine from the Roman and Byzantine periods*, Jerusalem (Ph. D. Hebrew University of Jerusalem).
- Di Segni, L./G. Foerster/Y. Tsafir, 1996: A decorated altar dedicated to Dionysos the 'Founder' from Beth Shean (Nysa-Scythopolis), *Eretz Israel* 25, 336-350 (Hebr.), 101* (Engl. abstract).
- Duchemin, J., 1979: La justice de Zeus et le destin d'Io. Regard sur les sources proche-orientales d'un mythe eschyléen, *Revue des études grecques* 92, 1-54.
- Eck, W., 2003: The Language of Power. Latin in the Inscriptions of Iudaea/Syria Palaestina, in L.H. Schiffman (ed.), *Semitic Papyrology in Context*, Leiden/Boston, 123-144.
- Eck, W., 2007a: *Rom und Judaea. Fünf Vorträge zur römischen Herrschaft in Palaestina*, Tübingen.
- Eck, W., 2007b: *Rom Herausfordern. Bar Kochba im Kampf gegen das Imperium Romanum*, Rom.
- Fitzgerald, G.M., 1927: Two inscriptions from Beisan, *Palestine exploration fund. Quarterly statement*, 150-154.
- Flusser, D., 1974: Paganism in Palestine, in S. Safrai/M. Stern (eds), *CRINT I. The Jewish people in the first century*, Assen/Amsterdam, 1065-1100.
- Foerster, G., 1980: A cuirassed bronze statue of Hadrian from a Roman fort near Beth Shean (Scythopolis), *Israel museum news* 16, 107-110.
- Foerster, G., 1985: A cuirassed bronze statue of Hadrian from a Roman fort near Beth Shean (Scythopolis), *Atiqot English series* 17, 139-160.
- Foerster, G., 2000: A statue of Dionysos from Bet Shean (Nysa-Scythopolis), *Ἀγαθὸς δαίμων. Mythes et cultes. Études d'iconographie en l'honneur de Lilly Kahil*, Athens (*Bulletin de Correspondance Hellénique* Suppl. 38), 135-142.
- Foerster, G./Y. Tsafir, 1986/87: Nysa-Scythopolis. A new inscription and the titles of the city on its coins, *Israel Numismatic Journal* 9, 53-58.
- Foerster, G./Y. Tsafir, 1990: Bet Shean. Un centre urbain raffiné, *Le monde de la bible* 66, septembre-octobre, 29-36.
- Foerster, G./Y. Tsafir, 1992: Nysa-Scythopolis in the Roman period: 'a Greek City of Coele Syria'. Evidence from the excavations at Bet Shean, *ARAM. Society for Syro-Mesopotamian studies* 4, 117-138.
- Foerster, G./Y. Tsafir, 1993: City center (North), *Excavations and surveys in Israel* 11 (*The Bet She'an excavation project, 1989-1991*), 3-32.
- Foerster, G./Y. Tsafir, 2002: Skythopolis. Vorposten der Dekapolis, in A. Hoffmann/S. Kerner (eds), *Gadara, Gerasa und die Dekapolis*, Mainz (Antike Welt, Sondernummer), 72-87.
- Frézouls, E., 1988: Fondations et refondations dans l'Orient syrien. Problèmes d'identification et d'interprétation, in P.-L. Gatier/B. Helly/J.-P. Rey-Coquais (eds), *Géographie historique au Proche-Orient*, Paris, 111-131.
- Fuks, G., 1983: *Scythopolis. A Greek city in Eretz-Israel*, Jerusalem (Hebr.).
- Gatier, P.-L., 1990: Nouvelles archéologiques. À propos de la Coelé-Syrie, *Syria* 67, 204-206.
- Geiger, J., 1990: Local patriotism in the Hellenistic cities of Palestine, in A. Kasher/U. Rappaport/G. Fuks (eds), *Greece and Rome in Eretz Israel*, Jerusalem, 141-150.

- Geiger, J., 1996: How much Latin in Greek Palestine?, in H. Rosen (ed.), *Aspects of Latin. VIIIth International colloquium on Latin linguistics (Jerusalem, 1993)*, Innsbruck, 39-57.
- Gergel, R.A., 1991: The Tel Shalem Hadrian reconsidered, *American Journal of Archeology* 95, 231-251.
- Gitler, H., 1990-1991: Numismatic Evidence on the Visit of Marcus Aurelius to the East, *Israel Numismatic Journal* 11, 36-51.
- Glueck, N., 1937: A newly discovered Nabatean temple of Atargatis and Hadad at Kirbet et-Tannûr, Transjordan, *American Journal of Archeology* 41, 361-376.
- Grelle, F., 1972: *L'autonomia cittadina fra Traiano e Adriano. Teoria e prassi dell'organizzazione municipale*, Napoli.
- Grimal, P., 1988⁹ (1951): *Dictionnaire de la mythologie grecque et romaine*, Paris.
- Haensch, R., 1997: *Capita provinciarum. Statthaltersitze und Provinzialverwaltung in der römischen Kaiserzeit*, Mainz.
- Hall, J.F. 2002: *Hellenicity. Between Ethnicity and Culture*, Chicago.
- Harl, K.W., 1987: *Civic Coins and Civic Politics in the Roman East, AD 180-275*, Berkeley.
- Heller, A., 2006: Archaïotès et eugeneia. Le thème des origines dans les cités d'Asie Mineure à l'époque impériale, *Ktema* 31, 97-108.
- Hill, G.F., 1914: *Catalogue of Greek Coins of Palaestina in the British Museum*, London.
- Howgego, Ch./V. Heuchert/A. Burnett, (eds) 2007: *Coinage and Identity in the Roman Provinces*, Oxford.
- Isaac, B., 1981: The Decapolis in Syria. A neglected inscription, *Zeitschrift für Papyrologie und Epigraphik* 44, 67-74.
- Isaac, B., 1990a: *The limits of Empire. The Roman army in the East*, Oxford.
- Isaac, B., 1990b: Roman administration and urbanization, in A. Kasher/U. Rappaport/G. Fuks (eds), *Greece and Rome in Eretz Israel*, Jerusalem, 151-159.
- Isaac, B., 1998a: *The Near East under Roman rule. Selected papers*, Leiden/New York (*Mnemosynè* Suppl. 177).
- Isaac, B., 1998b: Jews, Christians and others in Palestine. The evidence from Eusebius, in M. Goodman (ed.), *Jews in a Graeco-Roman World*, Oxford, 65-74.
- Jacobs, M., 1998: Theatres and performances as reflected in the Talmud Yerushalmi, in P. Schäfer (ed.), *The Talmud Yerushalmi and Graeco-Roman culture I*, Tübingen, 327-347.
- Jeanmaire, J., 1970: *Dionysos. Histoire du culte de Bacchus*, Paris.
- Jones, A.H.M., 1930: The urbanization of Palestine, *Journal of Roman Studies* 20, 78-85.
- Jones, A.H.M., 1971: *The cities of the Eastern Roman provinces*, Oxford.
- Kadman, L., 1956: *Corpus Nummorum Palaestiniensium I. The coins of Aelia Capitolina*, Jerusalem.
- Kasher, A., 1990: *Jews and Hellenistic cities in Eretz-Israel*, Tübingen.
- Kern, O., 1923-1924: Ein vergessenes Dionysosfest in Jerusalem, *Archiv für Religionswissenschaft* 22, 198-199.
- Laniado, A./R. Last/P. Porat, 1993: A dedication to Galerius from Scythopolis. A revised reading, *Zeitschrift für Papyrologie und Epigraphik* 98, 229-237.
- Lapin, H., 2000: Rabbies and cities. Some aspects of the rabbinic movement in its Graeco-Roman environment, in P. Schäfer/C. Hezser (eds), *The Talmud Yerushalmi and Graeco-Roman culture II*, Tübingen (Texts and studies in ancient Judaism 79), 51-80.
- Leschhorn, W., 1984: 'Gründer der Stadt'. *Studien zu einem politisch-religiösen Phänomen der Griechischen Geschichte*, Stuttgart.
- Lifshitz, B., 1961: Der Kult des Zeus Akraios und des Zeus Bakchos in Beisan (Skythopolis), *Zeitschrift des Deutschen Palästina-Vereins* 77, 186-190.
- Lifshitz, B., 1970: Notes d'épigraphie grecque, *Zeitschrift für Papyrologie und Epigraphik* 6, 57-64.
- Lifshitz, B., 1976: Bleigewichte aus Palästina und Syrien, *Zeitschrift des Deutschen Palästina-Vereins* 92, 168-187.
- Lifshitz, B., 1977: Scythopolis. L'histoire, les institutions et les cultes de la ville à l'époque hellénistique et impériale, *Aufstieg und Niedergang der römischen Welt* II.8, 262-290.

- Malkin, I., 1987: *Religion and colonisation in ancient Greece*, Leiden/New York (Studies in Greek and Roman religion 3).
- Mare, W.H., 1994: The 1992 season of excavation at Abila of the Decapolis, *Annual of the Department of Antiquities of Jordan* 38, 359-378.
- Meshorer, Y., 1985: *City-coins of Eretz-Israel and the Decapolis in the Roman period*, Jerusalem.
- Meshorer, Y., 1986-1987: The Coins of Dora, *Israel Numismatic Journal* 9, 59-72.
- Meshorer, Y., 1989a: *The Coinage of Aelia Capitolina*, Jerusalem.
- Meshorer, Y., 1989b: On three interesting cults at Neapolis in Samaria, in G. Le Rider/K. Jenkins/N. Waggoner/U. Westermark (eds), *Kraay-Morkholm Essays*, Louvain (Numismatica Lovaniensia 10), 173-177.
- Michon, E., 1913: Sarcophage représentant Bacchus et les génies des Saisons découvert à Tourmous'aya, *Revue Biblique* 10, 111-118.
- Millar, F., 1990: The Roman *coloniae* of the Near East. A study of cultural relations, in H. Solin/F.M. Kajava (eds), *Roman policy in the East and other studies in Roman history*, Helsinki, 7-58.
- Millar, F., 1993: *The Roman Near-East, 31 BC - AD 337*, Cambridge (Mass.).
- Moretti, L., 1953: *Iscrizioni agonistiche greche*, Roma.
- Mussies, G., 1990: Marnas, God of Gaza, *Aufstieg und Niedergang der römischen Welt* II.18.4, 2413-2457.
- Oden, R.A., 1977: *Studies in Lucian's De Syria Dea*, Missoula (Harvard Semitic Monographs 15).
- Ovadia, A., 1975: Greek cults in Beth Shean / Scythopolis in the Hellenistic and Roman periods, *Eretz Israel* 12 (N. Glueck Memorial Volume), 116-124 (Hebr.), Engl. abstract 122*.
- Pleket, H.W., 1965: An aspect of the emperor cult. Imperial mysteries, *Harvard Theological Review* 58, 331-347.
- Pont, A.-V., 2007: L'empereur 'fondateur': enquête sur les motifs de la reconnaissance civique, *REG* 120, 526-552.
- Rahmani, L.Y., 1975: The Erez mosaic pavement, *Israel exploration journal* 25, 21-24.
- Rahmani, L.Y., 1989: Roman Miscellanea, *Israel exploration journal* 39, 66-75.
- Rigsby, K.T., 1980: The cult of Zeus Olympios under the Seleucids, *Transactions of the American Philological Association* 110, 233-242.
- Robert, L., 1977: La titulature de Nicée et de Nicomédie: la gloire et la haine, *Harvard studies in classical philology* 81, 1-39 (= *Opera Minora Selecta* 6, 211-249).
- Rogers, G.M., 1991: *The Sacred Identity of Ephesus. Foundation Myths of a Roman City*, London/New York.
- Rosenberger, M., 1975: *City-coins of Palestine*, II, Jerusalem.
- Rosenberger, M., 1977: *City-coins of Palestine*, III, Jerusalem.
- Rosenberger, M., 1990-1991: Unpublished and rare city coins, *Israel Numismatic Journal* 11, 77-80.
- Rostovtzeff, M., 1942: *Vexillum and Victory*, *Journal of Roman Studies* 32, 92-106.
- Ruelle, C.A. (ed.), 1889: *Damascii successoris Dubitationes et solutiones de primis principiis*, in *Platonis Parmenidem*, Paris (2 vols).
- Rüpke, J., 2006: Religion in the lex Ursonensis, in C. Ando/J. Rüpke (eds), *Religion and Law in Classical and Christian Rome*, Stuttgart (Potsdamer Altertumswissenschaftliche Beiträge 15), 34-46.
- Sartre, M., 1988: La Syrie creuse n'existe pas, in P.-L. Gatier/B. Helly/J.-P. Rey-Coquais (eds), *Géographie historique au Proche-Orient*, Paris, 15-40.
- Sartre, M., 1991: *L'Orient romain. Provinces et sociétés provinciales en Méditerranée orientale d'Auguste aux Sévères (31 avant J.-C.-235 après J.-C.)*, Paris.
- Sartre, M., 2002: La construction de l'identité des villes de la Syrie hellénistique et impériale, in H. Inglebert (ed.), *Idéologies et valeurs civiques dans le monde romain. Hommage à Claude Lepelley*, Paris, 93-105.
- Savignac, R., 1904: Chronique. Notes archéologiques, *Revue biblique* 1 n.s., 82-84.
- Schäfer, P. (ed.), 2003: *The Talmud Yerushalmi and Graeco-Roman Culture*, III, Tübingen.
- Schürer, E./G. Vermes/ F. Millar/M. Black, 1973-1987: *The history of the Jewish people in the Age of Jesus Christ*, I-III, Edinburgh.

- Spijkerman, A./M. Piccirillo, 1978: *The coins of the Decapolis and Provincia Arabia*, Jerusalem (Studium biblicum franciscanum, Collectio maior 25).
- Stern, S., 1998: Dissonance and misunderstanding in Jewish-Roman relations, in M. Goodman (ed.), *Jews in a Graeco-Roman world*, Oxford, 241-250.
- Teixidor, J., 1977: *The pagan god. Popular religion in the Greco-Roman Near-East*, Princeton.
- Tsafir, Y., 1989: Further evidence of the cult of Zeus Akraios at Beth Shean (Scythopolis), *Israel exploration journal* 39, 76-78 [= *Eretz Israel*, 19, 1987, 282-283 (Hebr.)].
- Veyne, P., 2002: Lisibilité des images, propagande et apparat monarchique dans l'empire romain, *Revue historique* 304, 3-30.
- Vitto, F., 1991: Two marble heads of goddesses from Tel Naharon-Scythopolis, *Atiqot English Series* 20, 33-45.
- Welles, C.B., 1938: The inscriptions, in C.H. Kraeling (ed.), *Gerasa*, New Haven, 355-494.
- Welles, C.B./R.O. Fink/J.F. Gilliam, 1959: *Excavations at Dura Europos. Final report V. Parchments and papyri*, New Haven.
- Woolf, G., 1997: The Roman urbanization of the East, in S.E. Alcock (ed.), *The Early Roman Empire in the East*, Oxford, 1-13.

Ethnic discourses on the frontiers of Roman Africa

Dick Whittaker

- 1 Introduction
- 2 Context-based ethnicity
- 3 Ethnicity and culture
- 4 Ethnicizing and essentializing
- 5 Ethnicity and the state
- 6 Ethnic soldiers
- 7 Romanization

Abbreviations

References

I INTRODUCTION

Anthropologists have long voiced disquiet, although no agreement, about the concept of ethnicity, some dismissing it as an administrative fiction,¹ others finding it too vague to be an analytical term,² too objective to explain change,³ or too contested between ‘primordialists’ and ‘instrumentalists’ to be debated.⁴ Ethnography, says Amory, is ‘a discourse in anxious flux’, and hence the title of this paper.⁵

I shall cut through the modern debate by assuming without discussion the transactionalist definition of ethnicity established by Barth (1969) and others who have followed his line of argument, which I find the most satisfactory. This states (1) that ethnicity is not the same as culture, let alone an identifiable material culture; and to believe otherwise produces teleological ‘ethno-histories’ and ‘acculturation studies’; (2) that ethnic groups are self-ascriptive, mutable and context-based in history, often producing ethnic labels in periods of conflict; the frontiers they establish, consequently, are non-exclusive, and porous; (3) that ethnic groups, although primarily political and social systems, nevertheless have a built-in or ‘essentializing’ tendency to invent feelings of common descent, common religion, common icons, however mythical; (4) that ethnicity is not simply an invention of colonial powers to exercise bureaucratic control or to create martial units, although both can encourage symbols of unity; (5) that exogamy is the most effective destroyer of ethnic boundaries, even if it also encourages greater strategic manipulation of ethnicity.

The question that I have asked myself here is how much of this clarifies or lays bare the discourse about Roman rule in Africa (and by extension in other provinces of the empire), which is full of references to ‘tribal’ divisions, tribal military units and tribes on the frontiers. The growth of the Roman empire in fact has been described as a history of ‘ethnicity being harnessed’,⁶ and certainly the Romans were enthusiastic

¹ De Heusch 2000.

² Tibi 1991, 137-143; Tonkin *et al.* 1989, 11-17.

³ Hutchinson/Smith 1996, 15.

⁴ Jones 1997.

⁵ Amory 1997, 3.

⁶ Enloe 1980, 210.

ethno-hunters. It was an easy sport when you had access to archives of *formae provinciales*, geographic commentaries or itineraries. And Africa was an exceptionally fruitful field for such a passion.

Best known are the ethnic lists provided in the 1st century AD by Pliny the Elder, who claimed that there were 516 *populi* in Africa Proconsularis, of which 463 were non-*civitates*, although he named only 25. Ptolemy added to the list in the 2nd century AD and tried to locate them geographically. Further names of tribes were recorded on the Peutinger Table, probably derived from itineraries of the 2nd century AD, others were named in the spate of topographic catalogues that appeared in the later Empire (such as the Verona list, various *Cosmographia*, the Latin Excerpts of Jerome, and so on), drawn from earlier lists and commentaries. And finally today we have yet more ethnic names that turn up in the huge modern collections of inscriptions, which are more numerous in Africa than in any other province. Jehan Desanges who collected and collated almost all the references in his *Catalogue des tribus africaines* (1962) registered 420 names in the index. The problem, however, has always been what to do with such inventories. Certainly one should not try and pin point them onto maps nor to write ethno-histories. Both are doomed to failure, since that is not how ethnicity works.

Ancient reaction to these embarrassing numbers was usually to explain in uncomprehending ways how it was that tribes seemed to appear and disappear in different parts of the Maghreb. In Libya the Psylli tribe of snake charmers, said Herodotus, were buried by the South wind, though Agatharcides said they had been chopped to pieces by the Nasamones.⁷ Yet they reappeared later in Pliny's and Ptolemy's lists 'above' the Garamantes in the 1st century or on the borders of Cyrenaica in the 2nd century, and yet again serving as Vandal auxiliaries in the 5th century.⁸ The Nasamones, whom different authors placed at various points along the Grand Syrtes or in the oases of the East, were 'forbidden to exist' by Domitian in the later 1st century AD after they refused to pay taxes.⁹ But they were back again in Ptolemy's list and were still around in the later Empire as part of the Laguatan invasion of Tripolitania. The once mighty Masaesyli of central Algeria in Jugurtha's day (that is, during the 1st century BC) were *extincta*, if we believe Pliny. But, although Ptolemy subsumed them into the Numidians, they crop up again in the late 2nd or 3rd century in a Libyan bilingual inscription, this time on the other side of the Maghreb near Tetuan in Morocco.¹⁰ The Mauri said Pliny, though once a major *gens*, were now reduced to a few *familiae*;¹¹ yet from the 3rd century AD they dominated African ethnic history.

So, while we get some sense of movement from the ancient sources, we get no notion from them of the intrinsic instability of ethnicity, nor of the changing networks of dependence and circulation of elites within tribal communities. They knew all about wandering nomads, for example,¹² especially since fecklessness and vagabondage were supposedly typical of all barbarians. And the very name of the Numidae, so they believed, was a corruption of nomad. But Roman and Greek writers were all outsiders and in reality had no more interest in the anatomy of African tribes than they had during the later Empire in the identity of Franks and Goths, who received the same treatment. When Massinissa, the powerful Numidian chief of the Massyles in western Tunisia who helped to bring down Carthage, laid claim to 'ancestral lands' in Tripolitania some 500 km to the east of his capital, the Romans believed he was cheating, since that was what all natives did. They had no understanding of the nomadic concept of possession of 'terre de parcours' nor of territory as 'the science of movement'.¹³ I am not sure that modern historians of Roman Africa have done much better.

⁷ Herodotus, 4.173; Pliny, *NH* 7.13.

⁸ Pliny, *NH* 5.270; Ptol. 4.4.6; Sidonius Apollinaris, *Carm.* 5.337.

⁹ Cassius Dio, 67.5.6-7.

¹⁰ *RIL* 882.

¹¹ Pliny, *NH* 5.17; repeated by Ptolemy.

¹² Silius Italicus 3.2.90: *migrare per arva mos*.

¹³ Cf. Barth 2000, 19: 'Territory [is] the science of movement, not a field for the demarcation of plots'.

Little attempt in fact has been made to comprehend African ethnicity in terms of historical contingency and context-based identity. 'Ethnic divisions that grow into conflict', say two anthropologists recently, 'are in reality entirely new constructions that... never existed before'.¹⁴ The essence of ethnicity is its mutability, especially in periods of stress, while ethnic fictions and self-ascription draw readily on names and symbols of the past. The past glories of Massinissa must surely account for the name of the Massinissenses who appeared near Setif in central Algeria during the disturbed wars of Firmus in the 4th century AD.¹⁵ But they had nothing to do with the Tunisian kingdom of five centuries earlier. The same is true of the Musulamii, a powerful confederation of tribes who were first recruited as ethnic soldiers (with Tacfarinas as one of their leaders) while the Romans were penetrating southwards in the early 1st century AD. They are subsequently firmly located by inscriptions in the next century on the Tunisian-Algerian border as part of the nomadic movement coming out of the southern oases that Trajan and Hadrian wished to control. Yet in the 3rd century they suddenly appear near Tipasa on the coast of central Algeria, some 500 km to the West, when a governor of Mauretania fought against them.¹⁶ The circumstances are obscure, except that it was a known period of instability in the Ouarsenis Mountains when this inscription was put up, and the group was either newly formed, or it was the remnants of a Roman military ethnic unit once stationed in Mauretania whose recorded inscriptions disappear after the 2nd century.¹⁷ In neither case were they a fraction of the former Musulamii that had somehow survived and migrated, but a newly imagined community framed by historical circumstance – what Geary (1983) in the context of Merovingian Gaul calls a 'situational construct'.

The most spectacular examples of ideological manipulation and atavistic attachments, in order to create new ethnic groups, were under Juba I and his son, Juba II, during the Roman civil wars of the 1st century BC. Juba I was typically regarded by Romans as an unpredictable and cruel barbarian with tasteless dress and a funny hair style.¹⁸ But Juba knew how to play the ethnic game. He adopted symbolic, ethnic themes on his coins, such as the goat-god Ammon and the elephant head-dress, he made an 'ancestral' claim to command the Libyan tribes of Tripolitania, he appealed to old Massyles' memories by putting up honorific inscriptions to Massinissa in central Numidia, and he was able to win the support of Jugurtha's old alliance with the Gaetulians. All this made his alliance against Julius Caesar indispensable for the Pompeians. His son, Juba II, is usually dismissed as the puppet of Augustus, set up to control Mauretania. But he was more than a Roman cipher. His success in establishing his ethnic credentials in a region far removed from his Numidian heartland illustrates the ephemeral and political quality of ethnicity. It was not so much his Hellenistic court at Caesarea-Cherchel that made him valuable to Augustus but his capacity to control the Gaetolian and Garamantes desert tribes from Algeria to Tripolitania, and the western Mauri tribes as far as Volubilis in Morocco, a history largely unrecorded by Roman historians until he was challenged by Tacfarinas.¹⁹

Again it is the exploitation of African ethnicity by Juba II that is striking, despite his highly Romanized upbringing. We see that in his claim to Massinissa's patrimony,²⁰ in the ancestry he traced from Hercules-Melqart,²¹ and in his 'national' coinage figuring the iconic themes of Hercules, African lions and elephants. Forty years after his death and after a rebellion in the by-now annexed province of Mauretania, Sulpicius Galba, the Roman governor, thought it still expedient to honour Juba at Cherchel,

¹⁴ Whitehead/Ferguson 2000, preface, xxi.

¹⁵ Ammianus Marcellinus, 29.5.11.

¹⁶ *CIL* VIII, 20863 (corrects 9288): *Musula(mios) (g)entesque ali(as)*.

¹⁷ Holder 1980.

¹⁸ Cicero, *Ad Att.* 11.7.3 – probably referring to side-locks worn by Libyans for reasons buried in religious antiquity.

¹⁹ Cf. Cassius Dio, 55.28.3–4.

²⁰ Cassius Dio, 51.15.6; 53.26.2; Strabo, 17.3.7.

²¹ Plutarch, *Sert.* 9.

and twenty years later the pretender Luccius Albinus took the name Juba to win support.²² The name continued to be venerated at local shrines or recalled in the tribal names of the Baniubae of Morocco and the Jubaleni of central Algeria.

Self-ascription and historical context must also explain some of the many ethnic inscriptions that are found all over the Roman Maghreb. Usually they are assumed to be the relics of Roman administration and land cadastration, since the Latin text often makes reference to the emperor. Hence they are analysed and explained in terms of forced sedentarization and tribal containment. Some no doubt are, as I shall come on to discuss. But we cannot dismiss the possibility that sometimes the initiative for tribal identification was taken as a consequence of new, political consciousness among the local population in reaction to Roman power. For example, the inscription, mentioned earlier, commemorating the once powerful Masaesyli, was a bilingual in Latin and Libyan, and unlikely, therefore, to have been set up by Roman administrators.

Another example of what looks like self-ascription comes from the once powerful Numidae, whom the Romans encountered and recruited in their push towards the southern Aures mountains. But we find them also named on 2nd-century inscriptions 300 km to the North-West of the Aures where the plain meets the Biban mountains of Algeria. Two of them record *finis adsignati* by the *indulgentia* of Hadrian.²³ Why should it be assumed, as it is usually, that this refers to land marked out for the benefit of the provincial administration or imperial estates? The motive was almost certainly to safeguard the annual market, which lay nearby and happens to be recorded on another inscription, at a place called Vanisnesium.²⁴ State permission was usually needed for annual markets, but particularly in this part of Africa which has always been the meeting point, often the flash point, where huge, migrant tribal groups of the South encounter those of the highlands. For that reason markets were often placed under the guardianship of local gods or holy men, as the inscription records in this case.²⁵ The reference to the emperor's indulgence, therefore, is within the context of an appeal by a group seeking recognition, while exploiting the strategic use of ethnic labels and symbols to heighten their own political consciousness and claims.

Although Roman imperial power provided a new kind of glue to tribal cohesion, the process by which native peoples adopt elements of colonial power to construct a new ethnicity for themselves has been analysed in more recent empires by Said and others.²⁶ This poses a riddle of how to interpret many of the territorial inscriptions in Roman Africa. Another series of ethnic inscriptions concern the Musulamii, referred to earlier, which were connected with the work of Trajan's governor in his consolidation of the southern frontier stretching from the Aures Massif in Algeria to the salt lake Chotts of Tunisia. The frontier undoubtedly interfered with the traditional, free movement of nomadic groups, and the inscribed stones, set up officially between AD 102 and 106 on the fringes of a 100 km triangle in eastern Algeria, are usually, therefore, regarded as marking the area to which the movements of the Musulamii were restricted. That may be true. But they could nevertheless have also stimulated a new ethnic consciousness and identity among previously disparate tribesmen. Certainly the nomadic transhumance of the Musulamii did not cease. Rather like what happened in the case of the Numidae, an inscription was set up some 20 years later about 50 km to the East, recording senatorial permission for a regular market to meet on Musulamii territory at a strategic entry point to the high plains from the South. The permission was conditional on good behaviour and avoiding violence (*sine iniuria et incommodo*) in encounters with strangers, members of other tribes.²⁷ So although the context of the inscription was that of administrative control, yet the market served as a node of ethnic self-identity.

²² *AE* 1960, 595; Tacitus, *Hist.* 58–59.

²³ *CIL* VIII, 8813–8814.

²⁴ *CIL* VIII, 20627.

²⁵ Shaw 1995.

²⁶ Said 1994.

²⁷ *CIL* VIII, 270 = *ILTun* 396.

Frontiers, says Barth, are not for separation but conjunctions, ‘a constant field for opportunities for mediators, traders and middle persons of all kinds’.²⁸ The name ‘Numidian’ had many different meanings and became a vague identification of ‘the other’ for Romans, ‘a sort of frontier in public consciousness’.²⁹ This is very much like the way the name ‘Goths’ came to be used later on the northern frontier. It is not, however, ethnicity that defines politics but vice-versa – as recent tragic events among the Hutu of Rwanda have reminded us.³⁰ When the Bavares and Baquates of the western Algerian mountains became identified through a well-known series of treaty inscriptions in the period between the late 2nd and the 3rd centuries, we cannot ignore the fact that this was while the Severan frontiers were taking shape in the region. Roman sources talk about wars that ultimately compelled the tribal groups to make peace, using stereotyped descriptions of perfidious rebel attacks and barbarian fury and adding another of those vague ethnic, boundary terms, ‘Mauri’, for effect.³¹ But most modern commentators believe the encounters to have been much exaggerated and the series of treaties recorded on the inscriptions no more than normal diplomatic exchanges.³² It was this interaction that defined the identity of the groups. The episodes add evidence to what has recently been argued by Ferguson and Whitehead, that the supposed endemic tendency of all primitive people to engage in ‘pristine’ warfare is in reality a reflection of a colonial presence. ‘States make tribes’, they claim, in order to expand.³³

I shall return to the frontiers later. Here I simply want to expand the argument of contextuality by pointing out that multiple ethnic identity should not trouble us. The Greeks had many different loyalties, of which being a Hellene was only one, and usually less important than loyalty to the family, village, polis or to wider, ethnic groups (such as Arcadians).³⁴ Context was all important as to which label was claimed. The region of north-eastern Algeria around Hippo Regius has yielded an unusual concentration of inscriptions in the Libyan language. That is, they are self-ascriptive evidence, many of them bilingual with Latin added, of a tribal group who call themselves the Misiciri. One member of the Misiciri, however, calls himself Gaetulicus, evoking a wider loyalty to a confederation of the Gaetulan tribes.³⁵ We know that there was such a wider identity from the earliest reference to a tribal prefect in the reign of Nero referring to his responsibility for six Gaetulan tribes together.³⁶ The Macae and Nasamones were other prominent, but wider tribal groups in Tripolitania, clearly composed of what are often termed sub-tribes. But it makes more sense to consider them as ethnic units that appear or disappear according to historical exigency.³⁷ This corresponds to the way that Amory describes the Goths in later Roman history – ‘The edges of an ethnic group are always bleeding and healing as people leave it or join it.’³⁸ For example, the Baniouri and the Nababes could also be Quinquegentanei when fighting the Romans in the Kabylie mountains during the late 3rd and 4th centuries. The name, though Latinized, was not necessarily given them by the Romans to describe an alliance, since a contemporary Latin panegyricist calls them Mauri, and Julius Honorius listed them as a single tribe.³⁹ Identities were fluid and multiplex accordingly as friends and enemies chose.

²⁸ Barth 2000, 29.

²⁹ Desanges 1980b, 88.

³⁰ Enloe 1980, 7-8.

³¹ E.g. Pausanias, 8.43.3; *Historia Augusta*, *Pius* 5.4; *AE* 1907, 4 = *ILS* 9006.

³² Frézouls 1980, 1981, Février 1981.

³³ Ferguson/Whitehead 2000.

³⁴ Finley 1986.

³⁵ Whittaker 1993.

³⁶ *CILV*, 5267 (Como): *praefectus (...) nationum Gaetulicarum sex quae sunt in Numidia*.

³⁷ Mattingly 1995, 22-24.

³⁸ Amory 1997, 16.

³⁹ *Panegyrici Latini*, 9 (4).21.2; Julius Honorius, in A. Riese, *Geographi Latini Minores*, 1964 (1878), 47; cf. Desanges 1962, 67.

I have assumed that ethnicity is not a definition of culture, nor *a fortiori* of material culture.⁴⁰ Ethnicity is about how people feel, while material culture often crosses group boundaries. Pre-Roman Gaul had a number of highly diverse cultures as well as common features; but the differences were not defined by ethnic limits.⁴¹ The same seems to be true of the Maghreb, although, apart from studies of prehistoric monuments⁴² and the UNESCO Libyan Valleys survey,⁴³ there has been little rural archaeology. There is a certain broad, regional diversity between eastern burial chambers and dolmens, western stone circles and silo burials, and pre-Saharan tumuli burials. But, concludes Camps, who is the doyen of the pre-historians of the Maghreb, ‘La distinction entre *Afri*, *Numides* et *Maures* paraît, même aux auteurs anciens, plus livresque que le reflet d’une réalité ethnique.’⁴⁴

Language is much the same, insofar as one can judge by inscriptions. Certainly, there were notable differences in the survival and penetration of the Latin, Punic and Libyan languages. But they indicate regional, not tribal differences. Neo-Punic staged a revival in Tripolitania but not much elsewhere; around Hippo Regius there seems to have been a bunching of Libyan inscriptions (which may be an archaeological accident); while in the mountainous regions of the Kabylie and Aures there was a relative scarcity, though not total absence, of Latin. But again what Camps notes is ‘l’unité linguistique des anciennes populations du nord de l’Afrique’⁴⁵ and not the ethnic variations, despite a curious list of supposed tribal languages contained in the *Liber Generationis* that bears no relation to any other evidence.⁴⁶

If we look at cultural traits such as habitations, they obviously varied considerably between nomadic and settled populations, although the essential feature of transhumance was that ethnic separation between desert and town was minimized by symbiotic unions between the two. Nomads right across North Africa, however, were characterized in Roman authors to the point of stereotype by shared characteristics. All nomads, for instance lived in the same portable *mapalia* huts, whether they were Numidae (Pliny), Mauri (Pliny), Gaetuli (Sallust), Furni (Jerome) or Ethiopian Asphodelodes, the latter whose name supposedly derived from the rush matting of these dwelling. Even among the sedentary populations portrayed on mosaics, such as those at Oudna (Tunisia) and el-Alia (Tunisia), historians believe they can identify rural *mapalia*, which also seems to be the origins of place-names in agricultural regions, such as Mapalia Magna (Henchir Mettich) on the central Tunisian plain, Mapalia in eastern Algeria, or a suburb of that name in Carthage. So, whatever the distinctions in settlements, they were not tribal differences.

In religious practice, including the choice of the gods they worshiped, one might expect to find greater differences among the ethnic groups, since it is precisely the use of such symbols and icons that reinforces ethnicity. To some extent that is born out by worship of local deities, most obviously those called *genii loci*, that had a geographic particularity.⁴⁷ The Libyan bull god, Gurzil, that figured prominently as an icon of the Laguatan tribes in the 6th century, probably originated as the local god of Ghirza and derived his name from the place.⁴⁸ Yet it is also the commonality of the gods that strikes commentators, ancient and modern. Apart from a generalized practice and use of animism, magic, fertility, taboos and amulets, the saints and dead ancestors that were venerated may have had different names, but few had

⁴⁰ Hodder 1982; Jones 1997.

⁴¹ Woolf 1997.

⁴² Camps 1961, 1974.

⁴³ Barker *et al.* 1996.

⁴⁴ Camps 1980, 116.

⁴⁵ Camps 1980, 54.

⁴⁶ Riese, *Geographi Latini Minores*, 1964 (1878), 167: *gentes quae linguas habent, haec sunt...Mauri, Baquates et Massenas,*

Gaetuli, Afri qui et Barbares, Mazices, Garamentes qui et Marmarides, qui usque Aethiopiam extenduntur.

⁴⁷ E.g. CILVIII, 5884 = ILaIlg 2, 6865: *genius numinis caput (= capitis) Amsagae.*

⁴⁸ Mattingly 1995, 213.

distinctive personalities. ‘À première vue’, says Bénabou, ‘ces divinités ne se distinguent guère’.⁴⁹ Even Gurzil is found commemorated in 1st century Carthage and (probably) at Banasa in Morocco, as well as lending his iconic name to the tribe of Pagogurgenses and Aethogurgenses. The distinctions, in short, were ethnic but not cultural.

4 ETHNICIZING AND ESSENTIALIZING

Barth has been criticized for neglecting in his analysis pre-existing social systems which are part of the cultural influence that creates feelings of common descent. Ethnicity is not solely the result of social relations or political manipulation, since there is a group identity in origin upon which to mythologize, that is not the invention of the colonizer.⁵⁰ I agree with the argument, although, in that case, we all share in such essentializing, primordial feelings, whether we call it nationalism, patriotism or tribalism.

It is not hard to find such ethnicizing features of a mythic past in African tribal societies. El Bekri and Ibn Kaldoun in the Middle Ages preserved a long list of the supposed origins of Berbers, many of them with roots deep in antiquity. The problem for us in analysing such myths of ethnogenesis in North Africa, which are repeated by ancient writers such as Sallust or Strabo, is to know how much was the creation of outsiders, how much that of self-identification, even if stimulated in response to political pressures from Carthaginians and Romans. Some seem to be clear colonial importations; for example, how wandering Persians, who arrived carrying their *mapalia*, intermarried with Gaetulians and called themselves Nomads; or how Hercules, regularly identified with Phoenician Melqart, crossed over from Spain.⁵¹ Pliny claimed that the Pharusii, a nomadic tribe of Morocco, owed their name to the Persians who came over with Hercules, just as Augustine believed the Chenani who told him (in Punic) that they were descendants of the Chananaeci or Canaanites.⁵² These look like imported aetiologies. But we also know that Hiempsal, descendant of Massinissa, possessed *libri punici* that ended up in the possession of Juba II and were still around in the time of Augustine.⁵³ So even if the mythology was imported, it is not hard to imagine how these two royal chiefs might have exploited the myths to reinforce their own ethnic pedigrees.

Other essentializing features I have already touched upon. Religion and divine associations, for example, were important for group identity. Although it is much debated whether African tribal groups deified their leaders, there is no doubt that royal tombs, such as the huge Medracen burial chamber in the southern marches of Algeria, were places of worship.⁵⁴ Some tribal groups added theophoric names for self-ascriptive identity, like the Massinissenses, noted earlier. Royal names were associated with Jupiter or Ammon and appear on inscriptions or in literary sources. The annual market of the Numidae at Vanisnesium, that I discussed earlier, owed its foundation, according to the inscription, to *Jovis (sic) et Juba et genius Vanisnesi* as well as to unknown tribal gods called the *dii Ingirozoglezim*. The sacred personalities were there to protect market transactions, much as later Arab tribes employed the shrines of saints and marabouts.⁵⁵ Minucius Felix and Cyprian, both of them probably Africans of the late 2nd and early 3rd centuries, say that Juba was made a god by the Mauri, at a time which was also exactly when the ethnicity of the Mauri was asserting itself against the Romans.⁵⁶ Resistance is one of the historical processes that creates ethnic identity. Medinisses, general of the Mauri resistance to the Byzantine reconquest of Africa

⁴⁹ Bénabou 1976, 295.

⁵⁰ De Heusch 2000.

⁵¹ Sallust, *BJ* 18.3–8.

⁵² Pliny, *NH* 5.16; cf. Derks 1998, 100 ff. and Roymans 2004, 235 ff., on imported myths in Gaul which anchored ethnic groups to the world outside.

⁵³ Sallust, *BJ* 17.7; Augustine, *Ep.* 17.2; Lancel 1995, 358–360.

⁵⁴ Bénabou 1976, 285.

⁵⁵ Shaw 1995.

⁵⁶ Minucius Felix, *Oct.* 21.9; Cyprian, *Inst. div.* 1.15.6.

bore a name that is surely a distortion of Massinissa.⁵⁷ Antalas, one of the attacking Laguatan chiefs in the 6th century, was said to have been chosen by the oracle of Ammon.⁵⁸

Ethnic soldiers inevitably adopted ethnic icons of gods and ancestors as agents of esprit de corps, which played upon the essentializing character of African ethnicity. The best known and most discussed are the Mauri military units that served Rome, whose *dii Mauri* or *dii patrii* were honoured on inscriptions of the 3rd century in North Africa and in other parts of the empire.⁵⁹ The unusual characteristic of the Mauri, who rapidly evolved into crack units of the imperial *comitatus*, was that, despite a certain amount of dilution, as always happened when ethnic units were posted abroad,⁶⁰ many of the units made greater efforts to preserve and encourage their corporate identity than most others. So much so that Mommsen regarded them as barbarian federates *avant la date*, with their special hair styles, special rates of pay and their especially savage ways of fighting.⁶¹ The *dii Mauri* served an essentializing purpose that put an ethnic weapon in the hands of the Roman state. But the weapon ended up as a two edged sword.

5 ETHNICITY AND THE STATE

It is this facet of ethnicity, the exploitation of ethnicity by the state that was once believed by some anthropologists to have been the dominant feature of tribes in history; that is, that they were often no more than an administrative fiction and a political tool in the hands of a colonial bureaucracy – ‘an accomplice of colonialism’.⁶² Although there is more to ethnicity than this, we cannot ignore the practical desire of imperial powers to freeze the identity of the communities they encounter, or to harness the ethnicity of what they considered the ‘martial races’ on their borders. In the case of Roman North Africa, the process can be followed perhaps more clearly than in other provinces of the empire, thanks to the richness of the dossier of inscriptions.

Broadly speaking, the main imperial interests of the Romans in their provinces were security and taxation. In Africa this translated itself into a struggle to maintain the agricultural productivity of the sedentary population against the constant pressure of nomadic intrusions. The majority of ethnic names on inscriptions comes from territorial boundary stones whose purpose was either to compel nomadic communities of the southern pre-desert to settle on cadastrated (taxable) land or to regulate the time and place of seasonal transhumance by marking the permissible ‘terre de parcours’.⁶³ We have a celebrated series of inscriptions of the Nicives and Suburbures that have been interpreted either way.⁶⁴ In terms of historical contingency, therefore, such bureaucratic intervention inevitably halted or changed the cycle of construction and deconstruction of ethnic groups.

The fact is that on ‘the violent edge of empire’ states need ethnic leaders with whom to negotiate, and leaders need states to invent their own base of authority.⁶⁵ In North Africa, as the Roman state pushed its frontiers southwards and westwards from Tunisia to Morocco between the 1st and 3rd centuries, the process is well illustrated in two ways: by the administrative creation of managerial elites and by the military influence of frontiers and ethnic soldiers.

There seems to have been a standard procedure for taxation and recruiting in every frontier province, as soon as it was formed, through the use of *praefecti gentis*. In Africa this procedure is documented by a

⁵⁷ Procopius, *BV* 4.10.1-12.

⁵⁸ Mattingly 1995, 39, with references.

⁵⁹ Cf. Fentress 1978.

⁶⁰ E.g. *CIL* III, 6267 from Dacia Apulensis, probably early 3rd century AD.

⁶¹ Speidel 1975.

⁶² See the discussion in De Heusch 2000, 99.

⁶³ Whittaker 1993.

⁶⁴ Lancel 1955; Berthier 1968.

⁶⁵ Ferguson/Whitehead 2000.

dozen references from Nero to the later Empire.⁶⁶ Most of the prefects were Roman army officers who later rose in civil careers, although at least two in the 2nd century were African born – one a prefect of the Musulamii,⁶⁷ the other of the Gaetulian Cinithii,⁶⁸ and both possibly members of the tribes. If so, it was a forecast of the future. Besides the state prefects there were those with the title *principes gentis*, although other similar titles (such as *principes civitatis*) occur and all doubtless were used as general terms for leaders of local, tribal communities who sometimes existed side by side with urban magistrates.⁶⁹ By the later Empire it is evident that the two titles had merged and the prefects, now regularly drawn from the tribes, were formally invested with state symbols of authority, perhaps rather like the *tribuni* of the *gentiles* who appeared at the same time in Tripolitania.⁷⁰

All this is well known and has been much discussed. But what interests me is the use of prefects and *principes* in a dual role, both as instruments of urbanization and as managerial elites to control the border *gentes*. Again, the process seems to have been standardized and, allowing for the particularities of Africa (such as nomadism), may well be a paradigm for other western provinces. To the two examples of African-born prefects already noted, we can add the *princeps Numidarum*.⁷¹ He was not a prefect but he shared with the others the functions of leading the *gentes* while at the same time holding an urban magistracy in one of the urban centres or *civitates* that lay within the tribal areas, many of which eventually became Roman *municipia* and even colonies. This was at the very time in the 2nd century when the southern Algerian-Tunisian frontier was being consolidated and when territorial restrictions were being imposed on some of these same tribes.

Those who have argued that the *gentes* were in this way left unchanged and did not become part of the *civitas*, are almost certainly correct. Instead they were ‘attributed’ (or attached) to the urban centre in a manner that is documented earlier in Italy. Administratively, however, they were drawn into the urban network through the new Afro-Roman ‘managers’; that is to say, by men drawn from the ethnic élite who at the same time became part of the Romanized, urban aristocracy.⁷² The more one looks, the more cases appear to fit this model, although at various, different stages of evolution. For example, further west in the colony of Sitifis an inscription records a *princeps* of the Musuni *gens*, a tribe whose territorial markers appear in the same region.⁷³ The nomadic Nicives and Suburbures, whose territory was defined in the 2nd century, also appear to become attached to urbanized centres, the *civitas Nattabutum* and the *respublica* of the *gens Suburburum*, after the organization of the central Algerian frontier.⁷⁴

On the western limits of Mauretania Tingitana we can see what appears to be the first stage of the evolution of this process in the celebrated Tabula Banasitana, an inscription of the later 2nd century.⁷⁵ It records a tribe, almost certainly attributed to the colony of Banasa, whose *princeps* with his family was awarded Roman citizenship, in return for which he recognized his duty to collect tribute and recruits, as is recorded in Caracalla’s edict of 216.⁷⁶ Their condition resembles the first stage of transition from *gens* to *civitas* status on other frontiers. Tacitus, for example, records a similar process taking place among the northern border tribes, the Batavi, the Frisii and the *gentes* of Raetia and Noricum.⁷⁷ In the light of later history in Africa, the most interesting example of *principes gentis* (or in this case *primores*),⁷⁸ after the establishment of a *civitas* centre for the élite, is at Altava, which was founded as a military post on the border of Mauretania Caesariensis

⁶⁶ Leveau 1973; e.g. *CIL* VIII, 7554: *praefecto gentis Numidarum, dilectatori tironum ex Numidia lectorum*.

⁶⁷ *CIL* VIII, 5351 = *ILAlg* 1, 3992.

⁶⁸ *CIL* VIII, 10500.

⁶⁹ Kotula 1965.

⁷⁰ Mattingly 1995, 195–197; cf. Matthews 1976 for Mauretania Caesariensis.

⁷¹ *AE* 1905, 10 = *ILAlg* 1, 1297.

⁷² Christol 1988.

⁷³ Desanges 1980a.

⁷⁴ Lancel 1955.

⁷⁵ *LAM* 94.

⁷⁶ *LAM* 100; Christol 1988.

⁷⁷ *Tac. Hist.* 4.25, *Ann.* 4.72, *Hist.* 5.25; Gascou 1992.

⁷⁸ *AE* 1935, 86.

after the frontier with the Mauri tribes became defined in the Severan period. Such a system of attachments meant that ethnic boundaries overlapped with, but also extended beyond, formal, Roman administered territory, since tribute and recruits were being regularly drawn from the *gentes*.⁷⁹

6 ETHNIC SOLDIERS

We know very little about ethnic military units in the early Roman army of Africa, but we may assume that Roman commanders made the usual calculations of what have been called ‘situational risks’ in such circumstances – that is, how to turn peasants and herdsmen into soldiers within the wider polity by exploiting a false or artificial, ethnic consciousness, without at the same time creating a rod for their own backs.⁸⁰ Tacfarinas’s rebellion in the 1st century AD was a clear example of such risks, after he had served as a Musulamius auxiliary; and further similar experiences on the Rhine frontier turned the Roman administration away from the policy of employing ethnic auxiliaries on home fronts. So, while African ethnic units begin to appear in our army lists to coincide with the Flavian and 2nd-century drive towards the southern frontiers, none seems to have had local postings. The second Flavian equestrian cohort of Numidians is found in Thracia, the first cohort of Numidian archers in Syria, and so on.⁸¹ Only the first Flavian cohort of Musulamii is recorded in the Maghreb, but that, too, was well away from home territory in Mauretania Caesariensis; and it disappears after Hadrian.

In general, within such units it appears that little attempt was made to maintain ethnic purity by recruiting, so that they must have quickly become diluted and artificially ethnicized once they left home territory. True, one of the few individual records we possess is of a veteran from a cohort of Musulamii who returned to the town of Thubursicum Numidarum to join the Roman citizen, urban elite, thereby reinforcing the ties between *gens* and *civitas*.⁸² The same seems to have been true of the large numbers of Gaetolian veterans and wives whose seventy known inscriptions show them preserving *Gaetulicus* / *Gaetulus* as a cognomen in their Roman name.⁸³ They were proud of their origins, perhaps, but much more proud of their Roman citizenship and their military service, since the ethnic name was probably just as artificial as that of the present day Gurkhas in the British army. These ‘Gaetulians’, too, settled for the most part in urban, often veteran centres.

It is difficult to know why the Romans changed their military policy towards foreign posting for ethnic units in the course of the 2nd and 3rd centuries, at the time when the Severan frontiers of central and western Algeria were being defined. If we can judge by other periods of history, ethnicity and the use of ‘martial races’ becomes diluted in the army when central state institutions consolidate; and the converse happens when the army plays a greater role in politics.⁸⁴ The latter is what happened in the Severan period. But we should also take into account, as I argued earlier, that Roman expansion ‘tribalized’ the frontier populations. The development of Severan Mauretania coincided with the rise to prominence of Mauri ethnic units in the 3rd century. Although Mauri units, most of them *numeri*, continued to be posted to other frontiers, including the frontiers in other parts of Africa, as was normal practice with regular auxiliaries, they now also appear extensively on the Mauretanian frontier or *praetensiones*,⁸⁵ and are particularly prominent in emergencies against other hostile Mauri tribes.⁸⁶

⁷⁹ This ambiguity was inherent in the frontier itself, and resolves the problem of whether or not such institutions were within or outside the empire; cf. Slofstra 2002, 27–28; Roymans 2004, 197.

⁸⁰ Enloe 1980, 3–6.

⁸¹ Holder 1980 gives the full lists.

⁸² *CIL* VIII, 4879 = *ILAlg* 1, 1335.

⁸³ Gasco 1970.

⁸⁴ Enloe 1980, 48.

⁸⁵ *CIL* VIII, 9047: *in territorio Auziensi praetendentes*.

⁸⁶ E.g. *AE* 1966, 597: *res prospere gestae in desp[erantissimam turbam et factionem]*.

A similar ‘nativization’ of the frontiers took place on the Tripolitanian *limes* in the same century, where the desert forts were garrisoned partly by cohorts of Afri and irregular *numeri*, some of whom were presumably recruited from the adjacent Libyan *gentes*, as was standard procedure. That is a plausible explanation to account for the low-grade ‘latin créole’ found in military records in the outposts, which was a foretaste of the frontier Latin argot used by *gentiles* in the following century.⁸⁷ We have, however, no evidence that the change in military policy ever resulted in such ethnic units betraying the imperial frontiers by joining forces with hostile tribes beyond. True, we do have some examples of Mauri being used by imperial pretenders, but that argues more for regional esprit de corps rather than for treachery against Rome. In the events of AD 235, when Gordian I declared Africa Proconsularis for the senate against Maximinus, some Mauri units (according to the Augustan History) on the Numidian frontier supported the military governor of Numidia in putting down the civilian usurpation.⁸⁸

The Roman frontiers, in fact, had created two kinds of ethnicities: one in reaction to Roman power provoked among people beyond the *limes*, and the other by ideological manipulation of ethnicity in the military units of the imperial army. By the 6th century Corippus’s account of the Byzantine reconquest divided African ethnicity into good ‘Afri’ and bad ‘Mauri’. The first were Roman in spirit (*animo Romanus*) and peaceful; the other – pointedly called *gentes* – were stereotyped by savagery, barbarity, treachery and paganism.⁸⁹

7 ROMANIZATION

For the last part of this paper I want to shift the discourse on ethnicity to the concept of ‘Romanization’, which these days appears to have become a dirty word, with an even dirtier historiographic past, tarnished by imperialism, colonialism and ethnocentricity. The criticism of the term in recent polemics has focused on its cultural implications.⁹⁰ Although this is not the place for a full discussion, the debate can be briefly summarized as follows:

First and most vociferously, it is argued, the concept of Romanization does not account for the multiplicity of cultural responses within the Roman empire, nor indeed within Italy itself. We should be debating not uniformity, say the critics, but the new ‘cultural logic’ of variations and the ‘cultural bricolage’ of provincial civilizations.⁹¹ Most of this stress on diversity is the result of the growing industry of provincial histories and regional archaeology, since it is here, archaeologists claim, that ‘Romanization’ misreads material cultures; that is, it takes no account of the archaism and symbolism of artefacts, the relationship between material goods and imperialism or between materialism and identity.⁹² Nor is Roman material culture the same as Roman identity.

A second thrust of the debate concerns the nature and mode of cultural change, whether it was imposed from above by the state or adopted from below through the emulation of local elites.⁹³ Some prefer the notion of a resolution or accommodation between the clash of cultures; others the idea of a bargain for power. But despite local cultural variations, some argue, we cannot dismiss the evidence of overriding Roman imperial power displayed through similar styles adopted simultaneously over widely

⁸⁷ Marichal 1992, 46–48; Mattingly 1995, 169.

⁸⁸ *Historia Augusta, Gord.* 15.

⁸⁹ Février 1985.

⁹⁰ Summaries of the debate are in Le Roux 2004, and in Keay/Terrenato 2001.

⁹¹ Woolf 1997. The term ‘cultural bricolage’ is used by Terrenato 1998.

⁹² Hingley 1996.

⁹³ The classic study is Millett 1990.

diverse areas and provinces.⁹⁴ So, the question is, what was specific about Roman ideology and Roman practice to produce this effect.⁹⁵

A third, interesting facet of the debate is equivocal about the very term Romanization, and goes beyond a purely cultural definition to talk of cultural myths used for legitimation of empire, of the invention of tradition, of new imagined identity and new 'media of representation'.⁹⁶ The focus is on the manipulation of identity through language or symbols of communication; or how public and private inscriptions and texts convey multiple identities. This comes closest to the discourse on ethnicity and is worth expanding in this paper.

Romanization is, of course, a modern word. But used in an ideological and ethnic sense, the term is revalorized. 'Being Roman' should not even be expected to mean uniformity or acculturation (even if that happened sometimes), much less the adoption of a specific material culture. If Weber was right that, 'It is primarily the political community, no matter how artificially organized, that inspires belief in a common ethnicity,'⁹⁷ there is no reason why the Roman community should be excluded from the generalization. We should not fall into the trap of confining discourses on ethnicity to the third world or, in the Roman context, of limiting ethnicity to so-called tribal societies. We can test this by applying the assumptions with which I began, while using Roman Africa as the example.

It is hardly worth pausing over the truism that being Roman was not a claim to cultural uniformity. It is obvious that Seigneur Julius, the elegant villa owner who appears on the mosaic at Carthage and Q. Apuleius Maxsumus (sic), a Libyan farmer who has left his semi-literate inscription in the Tripolitania Gebel, were worlds apart. But both were Roman citizens and this is the important, specific fact of Romanization. We are not talking here about general uniformity, and certainly not about a uniform material culture. Nor did a Roman identity preclude other ethnic ascriptions, chosen according to the context. I noted earlier a bilingual from northern Algeria recording in the Libyan language a man as a member of the local Misiciri people, but who in the Latin version called himself C. Julius Gaetulicus, advertizing himself as an ethnic, Gaetulan veteran and a Roman citizen. The importance of communication through self-ascription and incorporation is stressed in all analyses of ethnicity, which was also peculiarly well suited to the Roman epigraphic habit. The public and private use of language and onomastics was a tool in Italian and provincial societies to assert local or Roman ethnic identity, sometimes simultaneously. On tombs in Lepcis Magna for example, the exterior inscriptions were in Latin for public recognition, but the underground container was inscribed in neo-Punic as a private claim.⁹⁸

One facet of the modern debate on ethnicity stresses the contrast between the Germanic myths of cultural communities (*Völksgemeinschaft*) and the French Jacobin ideal of common, legal rights.⁹⁹ The latter, I believe, offers a key to the Roman invention of ethnicity. *Civitas* or *agere civiliter* was an ideal implying common rights and duties that ineluctably shifted not just the juridical status of an individual but also that of a community and its cultural practices.¹⁰⁰ *Civitas* was an instrument of Roman ethnicity that extended to communities, even if they had not formally adopted municipal laws. Whatever the overt cultural differences, says Barth,¹⁰¹ what matters is what people *say* they are by 'continual expression and validation.' That more or less paraphrases the edict of Claudius concerning the Tridentine *gentes* when he said, 'Although I am aware that this category of people does not have much of an inherited claim to Roman *civitas*, nev-

⁹⁴ The introduction to Dondin-Payre/Raepsaet-Charlier 1999 is critical of those who lay such stress on provincial diversity that they create 'une impression curieuse, comme si ces provinces n'avaient pas été vu appliquer des règles.'

⁹⁵ Woolf 1992, 351-352.

⁹⁶ Woolf in Keay/Terrenato 2001, 178; Hingley 1996 goes so far as to doubt the value of the term Romanization.

⁹⁷ Weber 1979, 389 ff.

⁹⁸ Fontana 2001; cf. Vallat 2001.

⁹⁹ Brubaker 1992, 184-189.

¹⁰⁰ Whittaker 1997. The effect on religious practice is most forcefully stated by Scheid 1999.

¹⁰¹ Barth 1969, 79.

ertheless, since *they are said* to possess it by a long-standing claim (*longa usurpatione*),... I permit them to keep this legal status'.¹⁰² As I suggested earlier, *civitas* in Africa was the Roman bureaucratic instrument to bridge the gap between the urban, citizen elites, and the attributed ethnic *gentes*, so that they, too, might become Roman after 'a long standing claim' – as many of them did by the 3rd century.

If Roman *civitas* was essentially, like all ethnic devices, intended to promote a social and political system, there is no shortage of evidence of 'essentializing' symbols and myths that the state and communities invented to create feelings of common descent and solidarity. Apart from the more obvious common worship of the Roman Capitoline triad and of Roman emperors in urban centres or the Romanizing of native gods through *evocatio*, Roman provincials also invented new ethnic gods with pseudo-Roman credentials – Juno Caelestis for Tanit, Saturn for Baal Hammon and so on – many of whose religious titles reflected explicit loyalty to the new Roman ethnicity, by, for example, the addition of the title Augustus to a god's name. Virtues such as *amor civicus* or *amor patriae* were prominently displayed on inscriptions not only in a large cosmopolitan town such as Lepcis, but also in the frontier towns of Timgad and remote Altava, as they became widespread in the later Empire.¹⁰³ The *dii patrii* as alternatives for the *dii Mauri* were the military expression of similar ethnic loyalties. Although the Roman wolf and twins, as the mythical symbol of common Roman descent, appeared in several provinces, it has not so far turned up in Africa. But recollections of Troy and Aeneas were used to rally the Libyans and miserable Africans to the Byzantine cause.¹⁰⁴

Finally, to return to the frontiers, from where Barth began his reappraisal of ethnicity, we need to ask how Romanization – that is Romanization as an ethnic term – improves our understanding of what happened on North Africa's frontiers under Roman rule. The fluidity of the nomadic, southern pre-desert and the independence of the western Mauretanian mountain regions provide illustrations of how frontiers afford opportunities for 'conjunctions' rather than 'separations'.¹⁰⁵ We can trace the African cultural influence on the Roman *limes* through ethnic auxiliaries, but at the same time the Romanization of ethnic *gentes* through increasing citizenship and service in the legions. Many legionaries preserved their African origins through local cognomina, such as Donatus, Damapho and Saturninus. Not all such names necessarily derived from groups settled on the frontiers, but some names, such as Aurassus or Numidius, probably did. The frontier was at once the point of most rigorous ethnic enforcement (by military or bureaucratic devices), but, also, the most easily penetrated (through economic, cultural and demographic symbiosis). I can illustrate this best through reference to marriage among the frontier soldiers, keeping in mind the general principle that exogamy ensures the erosion of ethnic boundaries within a few generations.¹⁰⁶

Recent studies of marriage in the Roman army show, I believe, that in military camps and veteran colonies the birth rate was not sufficiently high to replace retiring legionaries, nor (more to the point) to produce enough 'wives' or partners for soldiers and veterans.¹⁰⁷ To make up the shortfall of women, if we take the example of Syria, the soldiers turned to *contubernatio* with local women.¹⁰⁸ But it is also becoming clearer that a fair number of such partners were slaves or ex-slaves, some of whom are explicitly registered as such on military inscriptions – like, for example, Cerennia Hilara, named as wife and *liberta* of a veteran at Lambaesis.¹⁰⁹ There were many others who would not have wished to advertise their servile origins but whose Romanized *nomen* repeats that of their husbands. About 17% of such wives must be classed as 'uncertain' for that reason.¹¹⁰ The figure could be even higher if Roman rules

¹⁰² *CIL* V, 5050 = *ILS* 206.

¹⁰³ Giardina 1988.

¹⁰⁴ Février 1985.

¹⁰⁵ Barth 2000.

¹⁰⁶ Van den Burghe 1995.

¹⁰⁷ I am aware these are contentious points (cf. Whittaker 2004, 137-138); I hope to publish a paper in the near

future with the evidence in detail.

¹⁰⁸ Tacitus, *Hist.* 2.80.

¹⁰⁹ *CIL* VIII, 3079 and p. 1740.

¹¹⁰ Calculated from the lists of military inscriptions in Le Bohec 1989 and Cherry 1998; cf. the discussion in Phang 2001, 331-2.

of onomastics were not strictly followed or were concealed – as, for example, in the case of the wife of T. Flavius Crispus, who is recorded as his *liberta* but with the name Ulpia Euphoreta that reveals nothing of the family attachment to her husband.¹¹¹

The commonest source of slaves, after home bred *vernae*, was the frontiers, although it is the most under-recorded.¹¹² For ordinary soldiers such slaves were also the cheapest. There were enough petty wars on the African frontiers to keep up the supply. For example, after the rebellion of the Bavares whole families were deported,¹¹³ not to mention the tax on imported slaves at the frontier post at Zarai, or Augustine's reference to Gaetulian captives sold by illicit slave traders.¹¹⁴ Interestingly, the latter were sometimes dressed as soldiers, no doubt because soldiers were common enough in the commerce not to attract notice. Even if we will never know the precise numbers, we can say that many of these ethnic slaves who became partners of soldiers, would probably have noticed little difference culturally or racially as they crossed the frontier, ultimately to become citizens and mothers of future Romans.

In short, if ethnicity is not a culture, but, in Weber's words, 'presumed identity' and 'fiction', then Romanization, which is historically contingent, shifting and *bricolée*, stimulated new – or the rediscovery of old – identities. Above all, as a strategy to maintain boundaries, Romanization served to define ethnic alterity, especially in periods of stress. But it did not enforce a physical or cultural iron curtain.

Later antiquity witnessed an expansion of the meaning of 'Romanus' all over the empire, while *gentes* both internally and externally took on new ethnic definitions that coincided with a new political consciousness.¹¹⁵ But being Roman was an ever more changing situational construct, especially among army groups who served both emperors and themselves, or among immigrants who settled within Roman territory. Many of these men were not Roman citizens. But *civitas* was no longer the index of Romanity, which was defined increasingly by how close a person was to the emperor. Theodoric briefly tried to unite his *gentes* by the revival of *civilitas*, but there were by then too many centres of political power.

In Africa the change is reflected in the evolution of the Mauri. The ethnic title had become at once a generic term for African units loyal to the emperor and the state's stereotype of ferocious savages and barbarians beyond the frontiers.¹¹⁶ The clearest indication of change comes from a 6th-century inscription from the Mauretanian border town of Altava when Roman administration was in transition. It honours a local *princeps*, Masuna, who seems to be called *rex gentium Maurorum et Romanorum*.¹¹⁷ Not only does this show the ambiguity of what used to be called a frontier, but it illustrates how Romanus and Maurus were now recognized as equivalent labels of ethnicity.

What conclusions, therefore, can we reach that are relevant to the great debate on Romanization? Being or becoming Roman, I have argued, cannot be measured by cultural change but by political integration. The stress is on rights and obligations, not on behavioural norms or material goods. This does not mean that there is no relation between the two. Adoption of Roman political practice carried with it cultural implications, such as the means by which a community organized its religious practice or its social organization, as well as the access it created for material influences in styles of living, trade and consumption. But while material innovations can be measured by archaeologists, they cannot be calibrated against ethnicity. Just as no modern commentator would dream of equating the consumption of Coca Cola or MacDonalD hamburgers in Europe with the assimilation of American identity (*au contraire* often), so the term 'Americanization', used in this material sense, means no more than Romanization. It can describe a measure of exposure to external influences but it is not a guide to substantive political change. Archaeology cannot dig up ethnicity and it is time the debate shifted to the domain of social history.

¹¹¹ Le Bohec 1989, 208 (note 236).

¹¹² Harris 1999.

¹¹³ *CIL* VIII, 21486: *familias eorum abductas*.

¹¹⁴ *CIL* VIII, 4508; Augustine, *Ep.* 10* p. 47, 1.8–11.

¹¹⁵ Amory 1997, 22–24.

¹¹⁶ Février 1985, 1986

¹¹⁷ *CIL* VIII, 9835 and p. 2059; Février 1988 doubts that Romans could be called a *gens*.

ABBREVIATIONS

<i>AntAfr</i>	<i>Antiquités Africaines</i>
<i>CIL</i>	<i>Corpus Inscriptionum Latinarum</i>
<i>IAM</i>	<i>Inscriptions Antiques du Maroc</i>
<i>ILAlg</i>	<i>Inscriptions Latines de l'Algérie</i>
<i>ILS</i>	<i>Inscriptiones Latinae Selectae</i>
<i>ILTun</i>	<i>Inscriptions Latines de la Tunisie</i> , Paris 1944
<i>RIL</i>	<i>Recueil des Inscriptions Libyques</i> (ed. J.B. Chabot)

REFERENCES

- Amory, P., 1997: *People and identity in Ostrogothic Italy, 489-550*, Cambridge.
- Barker, G.W.W./D.D.Gilbertson/G.D.B. Jones/D.J.Mattingly, 1996: *Farming the Libyan desert. The UNESCO archaeological survey in Tripolitania 1979-1989* (2 vols.), Paris.
- Barth, F., 1969: *Ethnic groups and boundaries*, Boston.
- Barth, F., 2000: Boundaries and conventions, in A.P.Cohen (ed.), *Signifying identities. Anthropological perspectives on boundaries and contested values*, London, 17-36.
- Bénabou, M. 1976: *La résistance africaine à la romanisation*, Paris.
- Berthier, A., 1968: Nicibes et Suburbures, *Bulletin d'Archéologie Algérienne* 3, 293-300.
- Brubaker, R., 1992: *Citizenship and nationhood in France and Germany*, Cambridge (Mass).
- Camps, G., 1961: *Aux origines de la Berbérie. Monuments et rites funéraires protohistoriques*, Paris.
- Camps, G., 1974: *Les civilisations préhistoriques de l'Afrique du Nord et du Sahara*, Paris.
- Camps, G., 1980: *Berbères. Aux marges de l'histoire*, Toulouse.
- Cherry, D., 1998: *Frontier society in Roman North Africa*, Oxford.
- Christol, M., 1988: Rome et les tribus indigènes en Maurétanie Tingitane, *Africa Romana* 5, 305-337.
- De Heusch, L., 2000: *L'ethnie*. The vicissitudes of a concept, *Social Anthropology* 8, 99-115.
- Derks, T., 1998: *Gods, temples and ritual practices. The transformation of religious ideas and values in Roman Gaul*, Amsterdam (Amsterdam Archaeological Studies 2).
- Desanges, J., 1962: *Catalogue des tribus africaines de l'antiquité classique*, Dakar.
- Desanges, J., 1980a: Un princeps gentis à Sitifis, *Bulletin Archéologique du Comité des Travaux Historiques* 12-14 B, 123-129.
- Desanges, J., 1980b: Permanence d'une structure indigène en marge de l'administration romaine. La Numidie traditionnelle, *AntAfr* 15, 77-89.
- Dondin-Payre, M./ M.-T. Raepsaet-Charlier (eds), 1999: *Cités, municipes, colonies colonies. Les processus de municipalisation en Gaule et en Germanie sous le Haut Empire romain*, Paris.
- Enloe, C.N., 1980: *Ethnic soldiers. State security in divided societies*, Harmondsworth.
- Fentress, E., 1978: Dii Mauri and Dii Patrii, *Latomus* 37, 507-516.
- Ferguson R.B./N.L. Whitehead, 2000: The violent edge of empire, in N.L. Whitehead/R.B. Ferguson (eds), 1-30.
- Février, P.-A., 1981: A propos des troubles de Maurétanie (villes et conflits au IIIe s.), *Zeitschrift für Papyrologie und Epigraphik* 43, 143-148.
- Février, P.-A. 1985: Les Maures ambigus ou les pièges du discours, *Bulletin Archéologique du Comité des Travaux Historiques* 19B, 291-306.
- Février, P.-A., 1986: L'Histoire Auguste et le Maghreb, *AntAfr* 22, 115-128.
- Février, P.-A., 1988, Masuna et Masties, *AntAfr* 24, 133-147.
- Finley, M.I., 1986: The ancient Greeks and their nation, ch. 7 in *The use and abuse of history*, London.

- Fontana, S., 2001: Leptis Magna. The Romanization of a major African city through burial evidence, in Keay/ Terrenato (eds), 161-172.
- Frézouls, E., 1980: Rome et la Maurétanie tingitane; un constat d'échec?, *AntAfr* 16, 65-93.
- Frézouls, E., 1981: La résistance armée en Maurétanie de l'annexion à l'époque sévérienne. Un essai d'appréciation, *Les Cahiers de Tunisie* 29, 41-69.
- Gascou, J., 1970: Le cognomen *Gaetulus* en Afrique romaine, *Mélanges d'Archéologie et d'Histoire de l'Ecole Française de Rome* 82, 723-736.
- Gascou, J., 1992: *Vici et provinciae* d'après une inscription de Banasa, *AntAfr* 28, 161-172.
- Geary, P.J. 1983: Ethnic identity as a situational construct in the early Middle Ages, *Mitteilungen der Anthropologischen Gesellschaft in Wien* 113, 15-26.
- Giardina, A. 1988: *Amor civicus*. Formule e immagini dell'evergetismo romano nella tradizione epigrafica, *La terza età dell'epigrafia. Atti del convegno AIEGL-Borghesi 86, Bologna, ottobre 1986, Faenza (Epigrafia e antichità 9)*, 67-85.
- Harris, W.V., 1999: Demography, geography and the source of Roman slaves, *Journal of Roman Studies* 89, 62-75.
- Hingley, R., 1996: The legacy of Rome. The rise and fall of the theory of Romanization, in J. Webster/ N.J. Cooper (eds), *Roman imperialism. Post-colonial perspectives*, Leicester, 35-48.
- Hodder, I., 1982: *Symbols in action*, Cambridge.
- Holder, P.A., 1980: *The auxilia from Augustus to Trajan*, Oxford (British Archaeological Reports Int. Ser. 70).
- Hutchinson, J./A.D. Smith (eds), 1996: *Ethnicity*, Oxford.
- Jones, S., 1997: *The archaeology of ethnicity. Constructing identities in the past and present*, London.
- Keay, S./N. Terrenato (eds), 2001: *Italy and the West. Comparative issues in Romanization*, Oxford.
- Kotula, T., 1965: Les *principes gentis* et les *principes civitatis* en Afrique romaine, *Eos* 55, 347-365.
- Lancel, S., 1955: Suburbures et Nicibes. Une inscription de Tigisis, *Libyca (Série Archéologie et Epigraphie)* 3, 289-298.
- Lancel, S., 1995: *Carthage. A history* (trans. A. Nevill), Oxford.
- Le Bohec, Y., 1989: *La Troisième Légion Auguste*, Paris
- Le Roux, P., 2004: La romanisation en question, *Annales (ESC)* 59, 287-311.
- Leveau, P., 1973: L'aile II des Thraces, la tribu des Mazices et les *praefecti gentis* en Afrique du Nord, *AntAfr* 7, 153-192.
- Marichal, R., 1992: *Les ostraca de Bu Njem*, Tripoli.
- Matthews, J., 1976: Mauretania in Ammianus and the Notitia, in P. Bartholemew/R. Goodburn (eds), *Aspects of the Notitia Dignitatum*, Oxford (British Archaeological Reports Int. Ser. 15), 157-186.
- Mattingly, D.J., 1995: *Tripolitania*, London.
- Millett, M., 1990: *The Romanization of Britain. An essay in archaeological interpretation*, Cambridge.
- Phang, S.E., 2001: *The marriage of Roman soldiers (13 BC-AD 235)*, Leiden/Boston/Köln.
- Roymans, N., 2004, *Ethnic identity and imperial power. The Batavians in the early Roman empire*, Amsterdam (Amsterdam Archaeological Studies 10).
- Said, E., 1994: *Culture and imperialism*, New York.
- Scheid, J., 1999: Aspects religieux de la municipalisation. Quelques réflexions générales, in Dondin-Payre/Raepsaet-Charlier (eds), 381-423.
- Shaw, B.D., 1995: Rural markets in North Africa and the political economy of the Roman Empire, ch.1 in *Rulers, nomads and Christians in North Africa*, Aldershot.
- Slofstra, J., 2002: Batavians and Romans on the Lower Rhine, *Archaeological Dialogues* 9, 16-38..
- Speidel, M., 1975: The rise of ethnic units in the Roman imperial army, *Aufstieg und Niedergang der Römischen Welt* II.3, 202-231.

- Terrenato, N., 1998: The Romanization of Italy. Global acculturation or cultural *bricolage*?, in C. Forcey/J. Hawthorne/R. Witcher (eds), *TRAC 97. Proceedings of the seventh annual Theoretical Roman Archaeology Conference, Nottingham, April 1997*, Oxford, 20-27.
- Tibi, B., 1991: The simultaneity of the unsimultaneous. Old tribes and imposed nation-states in the modern Middle East, in P.S. Khoury/J. Kostiner (eds), *Tribes and state function in the Middle East*, Berkeley/Los Angeles, 137-143.
- Tonkin, E./M. McDonald/M. Chapman (eds), 1989: *History and ethnicity*, London.
- Vallat, J.P., 2001: The Romanization of Italy. Conclusions, in Keay/ Terrenato (eds), 102-110.
- Van den Burghe, P., 1995: Does race matter?, *Nations and Nationalism* 1, 359-368.
- Weber, M., 1979: *Economy and society* (trans. E. Fischhoff *et al.*); G. Roth/C. Wittich (eds), Berkeley.
- Whitehead, N.L./R.B. Ferguson (eds), 2000² (1992): *War in the tribal zone. Expanding states and indigenous warfare*, Oxford.
- Whittaker, C.R., 1993: Land and labour in North Africa, ch.1 in *Land, city and trade in the Roman Empire*, Aldershot.
- Whittaker, C.R., 1997: Imperialism and culture. The Roman initiative, in D.J. Mattingly (ed.), *Dialogues in Roman imperialism. Power, discourse and discrepant experience in the Roman empire*, Portsmouth (RI) (Journal of Roman Archaeology, Suppl. 23), 145-163.
- Whittaker, C.R., 2004: *Rome and its frontiers. The dynamics of empire*, London.
- Woolf, G., 1992: The unity and diversity of Romanization, *Journal of Roman Archaeology* 5, 349-352.
- Woolf, G., 1997: Beyond Romans and natives, *World Archaeology* 22, 339-350.

Cruptorix and his kind. Talking ethnicity on the middle ground

Greg Woolf

Tacitus tells the story of the Frisian revolt of 28 AD as a case history in the brutality and stupidity of Roman provincial government.¹ The Frisii had for a generation been taxed in hides which were used by the army: 'because of their poverty' glosses the historian, although archaeologists will remember the importance of livestock in this local economy, and of leather in the production of Roman military equipment.² A senior centurion, assigned as district officer, demanded the hides of aurochs rather than cattle, or rather their equivalent in domestic hides. Forced requisitions of cattle, confiscations of land and enslavement of the families of defaulters eventually drove the Frisii into committing atrocities. The Romans holed up in the fort of Flevum to await the relief, which duly marched down the Rhine from Cologne led by the provincial governor, Lucius Apronius. Flevum was relieved but a subsequent punitive expedition into the marshes went horribly wrong. The Canninefates' cavalry, ordered to outflank the Frisii, were routed. The deployment of legionaries as reinforcements was bungled. Auxiliary infantry finally rescued the other units, but casualties were heavy. Tacitus' account ends with the fate of two detachments which had been cut off. One group had fought until morning in the grove of Baduhenna before being slaughtered. Another unit committed mass suicide after a panicky night hiding out in the *villa* of a former Roman soldier named Cruptorix.

Tacitus' Germany is forever a place of treacherous landscapes. Dark forests hide enemies and the traces of Roman disasters. Earlier in the *Annales* we have already been treated to the story of Germanicus' army stumbling onto the site of the Varian disaster, modern Kalkriese, with its bloody altars on which legionaries had been sacrificed to barbarous gods.³ This is territory that the Romans had once ruled but now had lost. Germanicus' invasion was a journey back in time to the once great Roman empire. Like the marshes that blur the boundaries between land and sea, Germany is fluid, intractable: when grasped, it drips through Roman fingers like mud. Roman energy can win victories in this terrain, but they are never long-lived. During the summers of AD 14, 15 and 16, Germanicus led his army across the Rhine at first to restore morale and discipline and teach Rome's enemies a lesson, later with wider aims in view. The language used by Tacitus deliberately recalls Julius Caesar's trans-Rhenine expeditions as narrated in his *Gallic war*. The campaign of AD 16 was nothing less than an attempt to recover the province lost by Varus seven years before.⁴ Germanicus concludes the campaign by setting up a great trophy, dedicated to Mars, Jupiter and Augustus on which he claims, in Virgilian language, to have defeated all the peoples between the Rhine and the Elbe. On the return journey, a great storm shatters the Roman fleet. Germanicus is shipwrecked and even contemplates suicide. When the survivors are gathered and ransomed, humiliatingly thanks to the mediation of the recently re-conquered Angivarii, they tell tales of hurricanes, strange birds, sea monsters

¹ Tacitus, *Ann.* 4.72-4.

² For the ecological frame, see Roymans/Theuws 1991, Roymans 1996. For the use of leather in military equipment, see Bishop/ Coulston 1993, 194, listing, among the products for which leather

was needed, footwear, belts, shield covers and covering, body armour, tents and horse harnesses.

³ Tacitus, *Ann.* 1.61.

⁴ Tacitus, *Ann.* 2.5-26.

and creatures half human, half animal, 'whether seen or simply imagined in terror'. They have been brought back from the ends of the earth.⁵

Vivid as these images are, they can obscure the complex mundanities of imperial rule and provincial identity in this part of the empire. Savage barbarian chaos did not, in fact, routinely confront Roman order on the Roman frontiers where patterns of interaction rapidly became established which created a relatively stable social landscape.⁶

Tacitus provides glimpses of these exchanges. The roles played by the Canninefates and Angivarii remind us that no Roman army ever marched in these regions without local allies. Then there are the scattered references to Germans who had been in Roman service. Segestes, leader of the pro-Roman faction among the Cherusci, sent as envoy to Germanicus his son Segimundus who had been priest at the altar in Cologne in AD 9 but had run off to join the rebels.⁷ The German leader Arminius was himself a former Roman soldier, and his brother, now with the unlikely Roman name of Flavus ('blondy'), was still serving under Germanicus. Tacitus stages a debate between the brothers on the banks of the Weser.⁸ A few chapters later an enemy horseman rides up to the Roman camp at night, calling out to them *in Latin* that Arminius would reward deserters with wives, land and pay at the rate of 100 HS a day. And then there is Cruptorix, a retired auxiliary, inhabiting a *villa* he has built for himself. Tacitus' purposes were complex: the moral gulf he fixed between Rome and Germany allowed the memory of the Varian disaster to hang over Germanicus' efforts in the present; provided an apologia for the failure of Roman imperialism and also an accusation of the emperors; enabled Germany to serve as Rome's antitype, its opposite as well as its limit; and established relations between his text and those of his predecessors, especially Pliny the Elder's massive *German wars* and Caesar's *Commentaries*.⁹ Yet it is clear that Tacitus was well aware that Germany was also and perhaps primarily a zone of interaction, and one in which information passed across a gradient.

Similar, if always unique, situations existed all along Rome's long frontier with northern Europe. The incorporation of the Batavi within the empire on terms that preserved old identities at the same time as assigning new roles has been described with subtlety.¹⁰ Roman-style buildings have been documented beyond the Danubian *limes*.¹¹ Widespread bilingualism among the Pannonians has been noticed.¹² Equally the existence of a broad zone beyond the frontier in which finds of Roman ceramic, coin and manufactured objects, has long been discussed.¹³ Those objects are all that remains of networks of exchange and travel that once extended far across the frontier. A throwaway comment in the *Germania* describes the special privileges enjoyed by the Hermunduri who alone were allowed to cross the Danube and travel wherever they wished in Raetia including to the provincial capital, while all other peoples had to conduct trade on the riverbank or at the camps.¹⁴ Roman explorers travelled far north of the river on occasion, presumably moving with traders, some from the provinces, others from neighbouring peoples who acted as intermediaries. The slave trade relied on barbarian slave-traders. And then there were the diplomatic travellers and hostages, like the son of Arminius born in the Roman empire of the daughter of Segestes.¹⁵ All these vectors of contact have been well studied. It is broadly agreed that, at this end of the empire at least, there are strong analogies to be drawn with other colonial situations in which, despite

⁵ On the presentation of the edges of the world in classical literature see Romm 1992.

⁶ For frontiers as zones of interaction see Whittaker 1994.

⁷ Tacitus, *Ann.* 1.57.

⁸ Tacitus, *Ann.* 2.9.

⁹ For Tacitus' construction of Germany as an antithesis of Rome in his (earlier) *Germania*, see O'Gorman 1993 with Rives 1999, 48-66.

¹⁰ Roymans 2004.

¹¹ Pitts 1989.

¹² Mócsy 1983.

¹³ From a vast bibliography see Fulford 1985, Hedeager 1987.

¹⁴ Tacitus, *Germ.* 41.

¹⁵ For this incident see Tacitus, *Ann.* 1.58. On the roles of these figures as cultural mediators see Creighton 2000.

sharp asymmetries in power and occasional instances of bloody confrontation, it is possible to see all parties contributing to new lifestyles. Individuals like Cruptorix passed back and forward between societies, becoming to some extent bi-cultural as well as bi-lingual. Able to operate in worlds that seemed at first completely alien to each other, they became cultural mediators or brokers and participated in creating new accommodations and in finding new common meanings.

Historians of the Americas developed the concept of the middle ground to describe a particular form of stable co-existence in a colonial situation. This situation was contrasted on the one hand with the dynamics of first contact, and on the other with situations in which the impact of colonizing powers led to a disintegration of indigenous societies. That latter situation is most familiar today, wherever industrializing nation states have impacted on small scale societies. But in the early modern period, some colonial populations co-existed for long periods with indigenous peoples.¹⁶ On the middle ground, a wide range of rapprochments and exchanges were developed, transforming both societies. Typically too there were individuals who moved between adjacent worlds; bilinguals, mestizos, traders, interpreters and the like. On the middle ground, however, there was some freedom and agency available to both sides. A contrast is usually drawn with styles of colonial rule in which the conquerors treated the land, possessions and bodies of the conquered as theirs to dispose of as they wished. Some colonial encounters moved rapidly to such an attempted obliteration of pre-contact orders. Land was treated as *terra nullius* territory without owners. Indigenous were treated as if children (as in Mexico) or even as sub-human (as in parts of Australia): in neither case were they regarded as having full human rights. But in many regions of the globe, first contact was not backed up by overwhelming military force and civilians – including traders, missionaries, trappers and settlers – were largely left to negotiate accommodations with local inhabitants and polities. On the middle ground, new arrivals had to make concessions to local customs. Equally, they brought with them goods, tools and ideas that were seen by some members of indigenous societies more as opportunities than threats. In regions like the Great Lakes region, these conditions lasted for generations. Entire peoples emerged whose ways of life, religion and identity was a product of intense but piecemeal exchanges. In retrospect we view these situations as transitional states, but at the time they were to all intents and purposes a new and enduring order of things.

Further distinctions might be made, and some qualifications. The contrast between the middle ground and what has been called *terra nullius* can easily be overdrawn. Probably no colonial society has ever really been able to do without accommodation, no imperial power has ever lived up to its fantasies of complete control, and no colonial episode has not generated at least some winners and some losers on both sides. Conversely, those who met on the middle ground were never exact equals. Even the complex web of commercial, sexual and religious relations constructed about Hudson's Bay between indigenous peoples and the first European whale-hunters and fur trappers – the paradigm for middle grounds around the world – was created on very uneven terms. Europeans had technological advantages, a biological edge given by their domesticated species and the pathogens they brought with them, and of course they had the freedom to leave the encounter. But in general it is true that there have been many colonial locales in history where complex local arrangements have been made and have endured sometimes for centuries. These middle grounds were by definition places of creative hybridization.¹⁷ Their authors were drawn from many groups. The Roman experience had its peculiarities, but many have imagined that in the frontier zone there were traders, soldiers, deserters and others from within the provinces who made lives

¹⁶ White 1991, compare Van der Leeuw 1983 drawing analogies between Hudson's Bay in the sixteenth through eighteenth centuries and the Low Countries during the Roman Empire. The most important application of the idea to archaeologi-

cal material is Gosden 2004, 82-113. See also Van Dommelen, 1998. This paper is indebted to all these works.

¹⁷ Thomas 1994 is a paradigmatic study.

for themselves beyond them as well as barbarians who, half civilized in the empire or its service, returned to societies that were no longer quite home. Men, that is, like Cruptorix.

Less often explored are the implications of all this for the generation of ancient ethnographic knowledge. By this I mean the processes of investigation, documentation and systematisation that lie behind our largely classical accounts of ethnic identity in temperate Europe just before and during the Roman period. Those processes are in general less studied than the texts that resulted from them, partly for positivist reasons, partly because of the intellectual habits of the modern disciplines most concerned. Only a few of these texts are ethnographies as such and only one, Tacitus' *Germania*, survives. Most ancient ethnography took the form of passages within histories or more rarely geographies (the intellectual fields were less clearly differentiated than today) or else is represented by ethnographic knowledge deployed in texts as diverse as medical treatises, encyclopaedias, forensic orations, epic poems and even satires and odes. Nothing like the present-day professions of cultural or social anthropology or ethnography existed with their evolved traditions of training and validation of research. But there were methodological debates, for example over the relative importance of autopsy and library study, over the key determinants of cultural variation and even over the best scale at which to write. There were key analytical categories not completely unlike our notions of 'culture' and 'society'. The idea of 'people' was variously described as *genos*, *ethnos* or *demos* in Greek or *natio*, *gens* or *populus* in Latin: each term had its own distinctive connotations.¹⁸

Modern study has focused much more, however, on how ancient writers chose to present, write or 'construct' other cultures than on how they found out about them. Given the centrality of classical texts to all accounts of ancient ethnicity, this is a matter of some concern. Indeed the truth-value of these accounts is itself controversial, some scholars treating them as essentially fictional, others assuming their broad veracity, yet others choosing to evade the issue by focusing on ancient *mentalités*, on literary tropes or the notion of a Roman *imaginaire*. A large strand of recent classical scholarship has viewed ancient ethnography largely in terms of the rhetorical redeployment of tropes of barbarism in the service of identity-building in the metropolitan core or else of the manipulation of ethnonyms for short-term political interest.¹⁹ Germans, Africans and Gauls line up as anti-Romans rather as Persians, Scythians and Egyptians are sometimes regarded as mirrors of the Greeks. Alternatively, the distinctiveness of Caesar's Germans is attributed to his need to make the crossing of the Rhine seem even more impressive to Roman audiences. Cultural constructionism, and a fascination with the generic, has deep roots within classical scholarship. In this field in particular, the influence of Foucault, Said and their admirers has been very strong. Stereotyping of barbarians has been presented as part of the creation of an imperial order of knowledge, a complementary means of subjugating Rome's enemies that can be considered alongside war and taxation.²⁰ Faith in the ideological content of Roman ethnography has undermined, for some, any belief in its historical value as evidence. The Chatti and Cherusci have been banished to a place in the Roman Imaginary, far from the mundane *Realien* of Roman manufactures found east of the Rhine and north of the Danube. This species of cultural history has not precisely challenged archaeologically informed investigation of ancient peoples so much as declared a lack of interest in engaging in such a conversation. That broader debate cannot be dealt with here, although I hope to return to it later.

¹⁸ Bickermann 1952 is the starting point for discussion of the ideas.

¹⁹ Harrison 2002 collects a range of recent treatments of Greeks and their neighbours. Hall 1989, Hartog 1988 and Cartledge 1993 offer contrasting cultural constructionist accounts of the othering of barbarians in Greek literature, with different emphases on the political and sociological components of

the process. For Romans and barbarians, see Woolf 1998 chapter 3 with bibliography.

²⁰ Nicolet 1988 for an influential but certainly not isolated example of this approach. See further most recently Murphy 2004. For the *Germania* the excellent studies of Bazelmans 1991, especially pp. 93-106, and O'Gorman 1993 illustrate the strengths, but also the limitations of this approach.

There are some good reasons to distrust extreme cultural constructionist readings of ancient ethnography. First, there is a growing recognition among historians of other periods that however important the imperial context of modern ethnographies may have been, and however real the asymmetries of power between questioner and respondent, empire did not generally determine the content of ethnography.²¹ Perhaps no one has ever asserted quite such an extreme position. Actual descriptions of alien peoples varied considerably. The Napoleonic *Description de l’Egypte* with which Said illustrated some of his arguments, is perhaps an example of an intellectual project unusually closely linked to an imperialist agenda, yet even here the spread of Egyptomania illustrates the capacity of the colonial subject to set some agendas for metropolitan society. On other occasions, it is clear that the descriptions written of native society and science often show a genuine exchange of ideas. This was the case in India under British rule, where the interaction can be observed from both sides.²² When the art and architecture of Europe during the eighteenth and nineteenth centuries are considered it is clear not only that actual (as opposed to imagined or constructed) cultural forms could be very influential on creativity at the heart of empire: the agency of some metropolitan artists was hardly linked at all to colonialist politics or attitudes.²³

Classicists too are now moderating their language when it comes to descriptions of the Other. The most recent work on Herodotus’ history, once a key text for students of *alterité*, makes more of Herodotus’ background in Ionian scientific enquiry than of his identity as a Greek.²⁴ Descriptions and dramatisations of Persians could play a part in Greek self-definition. Perhaps this was especially important in the period of major Greco-Persian conflict during the 5th century. But it is also clear that some 4th-century writers – Xenophon in the *Cyropaedia* and the *Anabasis* for instance – could produce very nuanced accounts of Persians and even hold up Persian kings and princes as models for imitation by Greek and Macedonian leaders. Greek practice is relevant to our enquiry, of course, since it was Greek writing that provided the main models for ethnographic discourse in Latin.

If we reject extreme cultural constructionist views of ethnography, it becomes all the more important to ascertain the sources of the information incorporated into ethnographic writing. Our extant texts do, of course, often carry information over from earlier writers. Much of Tacitus’ *Germania* derives from earlier works in Latin and Greek. But at some point information entered the written record. If we exclude the hypothesis that most of this information was invented, fictionalised on the basis of existing tropes about barbarians or else manufactured by inverting the norms of ‘civilized’ society, it is hard to escape the conclusion that at some point Roman writers relied, as many claimed they did, on local informants. None of this denies that opportunities existed to select, edit, repackage, gloss and reinterpret what they learned. Yet perhaps like those western scholars fascinated by Indian science, or those artists enraptured by Turkish architecture, sometimes there was no desire to fictionalise and stereotype. Among the characteristic assertions of authority made by ancient geographers, universal historians and encyclopaedists are claims to accuracy, to have discovered new facts, to have engaged in personal research, to have corrected the errors of predecessors and to have extended the collective body of knowledge.²⁵ It does not of course follow that ancient ethnographers were any more faithful and neutral recorders of colonial voices than are their modern counterparts. Most anthropologists now treat it as a given that, like it or not, they shape their material, if only by the questions they ask and their prior assumptions about what an ethnographic project involves.²⁶

²¹ E.g. Mackenzie 1995, Bayly 1996, Washbrook 1999 responding in different ways to Said 1978.

²² Bayly 1996.

²³ MacKenzie 1995.

²⁴ Thomas 2000.

²⁵ On these claims in Pliny the Elder see, for instance, Murphy 2004.

²⁶ Clifford/Marcus 1986 for an enormously influential contribution to what has become a fierce debate.

If we ask, then, how Tacitus knew about Germania, there is only one reasonable answer. He knew what Germans told him, and it was probably told in Latin by Germans who had learned the language in the course of years spent involved with Romans. This is a version of what James Clifford calls ‘the Squanto effect’ after the Anglophone Patuxet Indian, who met the Pilgrim Fathers in 1620, shortly after his own return from Europe, and helped them survive their first winter in the New World.²⁷ The modern myth of the ethnographer arriving out of the blue, immediately immersing him or herself in a new language, living as a native, and returning to the academy with new knowledge of a pristine culture was always a myth. There are always mediators, interpreters in a wide sense, and their own knowledge of both worlds cannot but influence the ethnographer and his or her descriptions, thick or otherwise, or the alien culture. Where for the Pilgrim Fathers there was Squanto, for Roman administrator-scholars there was Cruptorix and his kind.

This is much clearer from ancient ethnographies than from modern ones, since ancient writers did not live under the shadow of Malinowski and felt no qualms about declaring the sources of their knowledge. Polybius describes Scipio interrogating merchants in Gaul about the Tin Islands. Caesar is explicit that he learned of Britain from the Gauls. By what other ruter could Tacitus have learned of the great battle in which the Bructeri were annihilated by the Chamavi and Angivarii in a battle in which 60,000 Germans fell, or about the Kings of the distant Gotones? Roman knowledge of the alien was not brought back across a cultural divide so much as exchanged easily over a gentle gradient.

Parallel conversations were taking place all over the Roman world. One of Strabo’s sources for Spain was the writer Asclepiades from Myrleia in north-west Asia Minor.²⁸ Asclepiades taught *grammatike*, basic education, among the Turdetanoi of southern Spain at some point in the 1st century BC. Not much is known of his but he was also the author of an account of his native Bithynia and is described variously as an orator, a philosopher and a grammarian. He also wrote commentaries on Homer and some Hellenistic poets, and a work *On Orthography*. Asclepiades was part of a diaspora of Greek intellectuals who had earned their living first in Italy, and then all over the western provinces, as civic educators, itinerant performers and domestic retainers of the wealthy.²⁹ While teaching in Spain, Asclepiades wrote an account of the peoples of the region. Perhaps this was the first to be composed: it was certainly influential on the later accounts of Pompeius Trogus and even – at some remove – on late antique and early mediaeval accounts. Asclepiades testified that in the temple to Athena in the city of Odysseia in Spain there were shields and prows from Odysseus’ wanderings. He also described the wanderings of the Trojan heroes Teucer and Amphilocus elsewhere in Spain, and how some of Herakles’ companions and some Messenians colonised Iberia.³⁰ He found evidence of Spartan colonists in Cantabria and a city there founded by Antenor’s companion Ocelas. Strabo’s summary – all we have – strongly suggests that Asclepiades employed toponyms and perhaps ethnonyms as important clues in working out the identity of the founders of various Spanish peoples. That they were likely to have had founders, and ones identifiable from Greek myth, he took for granted as did many other scholars in his day.³¹

The best means of reconstructing the origins of peoples was a matter of controversy. Strabo describes how some scholars used Homer as the basis for their scientific hypotheses, while others rejected this method. One who did reject Homer was Pomponius Mela, whose *Chorographia*, written not long after

²⁷ Clifford 1999.

²⁸ Strabo 3.4.3. The fragments of Asclepiades’ works, which included a history of his native Bithynia, are gathered at Jacoby, *FGrHist* 697.

²⁹ On these movements see Rawson 1985 for the late Republic and Dueck 2000 for Strabo’s own day. Juvenal, *Satire* 6 and Lucian’s *On Salaried Posts* present hilarious

accounts of the phenomenon in the 2nd century AD.

³⁰ On the popularity of Trojan myths of origin in the west see Erskine 2001 and Roymans 2004, 235–8. For similar processes underway in Italy in a slightly earlier period see Wiseman 1983 and Dench 1995.

³¹ Bickermann 1952.

Strabo's *Geography*, has recently been characterised as a 'Phoenician geography'.³² Written in Latin by a Roman citizen from a Spanish town that had Carthaginian roots it does show some interest in the Punic geography of the pre-Roman Mediterranean. But it is difficult to tell how far it represents the survival of genuinely pre-Roman perspectives, rather than a meticulously constructed provincial identity. As in the case of Asclepiades, we seem to be dealing with the product of ethnographic investigation taking place on the middle ground, as part of the search for new meanings and accommodations.

Local erudits and visiting scholars around the empire joined forces to connect up the evidence of local myths, monuments and names to the Great Traditions of Hellenistic science and archaic myth. The researches of Asclepiades were conducted on the ground: whatever clues toponymy gave he seems to have followed up looking for hard evidence, for temples in which hard archaeological evidence was displayed. Tacitus and Ammianus both mention Greek inscriptions as evidence for the travels of Greek heroes in Europe. Whether or not – as seems likely – these are in fact mis-interpretations of Gallo-Greek inscriptions, there is at least an interest in testing scientific hypotheses against local information. Much of that local information is presented as local traditions. But it would be wrong to assume these were stories that had been told time and time again within indigenous societies long before Greek or Roman observers heard and transcribed them. Many of these informants were already well versed in Roman and Greek habits of thought, knew what counted as a good explanation, perhaps even knew the myths that Greeks and Romans told of their own origins. A small category of informants had received a Roman education as well as learning the language in the camps. Asclepiades' educational methods, after all, would have included teaching his pupils to read and memorize Homer. Perhaps it is no surprise that they and he, both saturated in the Greek classics together came up with some promising hypotheses about local history. The children of the western elites were learning their Latin from Virgil's *Aeneid* before going on to serve as commanders of auxiliary units.³³ Those units would be brigaded alongside legions in which senatorial youths like Tacitus and his pupils did their own military services before entering on a senatorial career. It is a strange thought that part of the common ground that Batavian chieftains shared with Italian military tribunes was that both groups had been driven through the *Aeneid* as children by Asclepiades' Latin teaching equivalents.³⁴ Not all would have been interested in discussing local history, but for those who were they shared a ready made language and conceptual framework.

Occasionally it is almost possible to reconstruct the broad lines of some of these conversations. Consider one of the most often discussed passages of Tacitus' *Germania*, the source of the phrase *interpretatio romana* which has been given so many meanings in modern literature since Wissowa first opened the debate.³⁵

In the land of the Nahanarvali is displayed a grove long held in awe. A priest in woman's dress presides, but the gods they speak of in Roman translation as Castor and Pollux: that is the essence of this divine power, the actual name is the Alci. There are no images, no trace of foreign superstition, yet they are worshipped as young men and brothers.³⁶

The context is a discussion of some of the most distant German tribes, a series of peoples of the Suebi inhabiting regions north of the Mittelgebirge and the Hercynian forest, on the borders of the territory of the Sarmatians. Nothing much is known of most but their names, and, in this case, one oddity of cult. The same chapter includes the information that the Cotini mine iron and the Harii paint themselves black. We are on the borders of the exotic, three chapters before the peoples said to be half human, half beast. What sort of sources can we imagine Tacitus – or just possibly the author of an unacknowledged

³² Batty 2000.

³³ A writing tablet from Vindolanda on Hadrian's Wall (*TV* 118) includes a line of the *Aeneid* quite plausibly the product of a Latin lesson in the commandant's house; see Bowman and Thomas 1994, *ad loc.* for discussion.

³⁴ Woolf 2000 for some discussion of this theme.

³⁵ Wissowa 1916–19 is the starting point. Webster 1995 for a very different view.

³⁶ Tacitus, *Germ.* 43.3, transl. Rives.

source – would be using? These details go beyond schematic Othering. Yet no Roman army had ever fought in that territory. These can only be German stories, told about Germans by Germans to Roman enquirers. The enquirer is invisible but the information that there are no images, and no trace of a foreign (*i.e.*: non-German) origin for the cult presupposes a process of interrogation. In support of the enquirer being Tacitus we might cite his earlier interest in the origins of what he supposes to be a German cult of Isis, and his probably military service in Cologne. So who supplies the identification with the Dioscuri? Given that the *Germania* stresses the unique features of the cult, it is unlikely to be Tacitus. The translation – the *interpretatio* – looks like the work of Germans familiar with Roman deities.³⁷

Classical authors did, of course, contribute to these conversations. One thing they brought was a set of research questions. Ancient ethnography was preoccupied with descent, with myths of origin, which operated for Greeks as a map of the past that underpinned present relations, what in other contexts have been called a ‘genealogical charter’.³⁸ The Hellenic genealogy explains the relationships of the three main linguistic groups of the archaic age, the Dorians, the Ionians and the Aeolians in terms of their descent from three brothers, the sons of an eponymous Hellen. Elaborations of the system gave Macedonians a slightly less close relation, mapped the Achaeans’ position, related Athenians to Ionians in Asia Minor and so on.³⁹ It is no surprise that Tacitus, or his source, sought similar information about German tribes.

‘In ancient lays, their only type of historical tradition, they celebrate Tuisto, a god brought forth from the earth. They attribute to him a son, Mannus, the source and founder of their people, and to Mannus three sons, from whose names those nearest the Ocean are called Ingaevones, those in the middle Herminones, and the rest Istaevones. Some people, inasmuch as antiquity gives free rein to speculation, maintain that there were more sons born from the god and hence more tribal designations – Marsi, Gambrivii, Suebi, and Vándilii – and that those names are genuine and ancient.’⁴⁰

Again, the observation that there are more than one version of the German genealogy in existence, presupposes a process of enquiry and information gathering. Roman enquirers had elicited similar stories about the Gauls. Livy for example offered this account that ‘made sense’ of the distribution of Gallic peoples in his own day.

‘While Tarquinius Priscus was king of Rome, the supreme power amongst the Celts, who formed a third part of the whole of Gaul, was in the hands of the Bituriges; they used to furnish the king for the whole Celtic race. Ambigatus was king at that time, a man eminent for his own personal courage and prosperity as much as for those of his dominions. During his sway the harvests were so abundant and the population increased so rapidly in Gaul that the government of such vast numbers seemed almost impossible. He was now an old man, and anxious to relieve his realm from the burden of over-population. With this view he signified his intention of sending his sister’s sons Bellovesus and Segovesus, both enterprising young men, to settle in whatever locality the gods should by augury assign to them. They were to invite as many as wished to accompany them, sufficient to prevent any nation from repelling their approach. When the auspices were taken, the Hercynian forest was assigned to Segovesus; to Bellovesus the gods gave the far pleasanter way into Italy.’⁴¹

It would be easy to multiply examples all the way back to Herodotus’ genealogy that explains the kinship of Etruscans and Lydians, but the main point is clear. Classical writers had a good sense of what

³⁷ Scheid 1991 for a parallel argument that interpretations among the Treveri presuppose local experts in Roman religion.

³⁸ Bohannon 1952, in relation to the Tiv.

³⁹ Hall 1997.

⁴⁰ Tacitus, *Germ.* 2.2, transl. Rives.

⁴¹ Livy, *History of Rome* 5.34, transl. Roberts.

constituted a proper explanation for the subdivision of a group of related peoples. The questions they asked and the way they organised what they heard left a definitive trace on the text.

There were many other presuppositions. Among them were the beliefs that language marked peoples; that peoples had distinct customs; that the climate of the regions they inhabited had a impact on customs and dispositions; that there were certain symmetries in the geography and ethnography of the world; that wealth or comfortable lands brought about softness and hardship or rugged terrain strength; that there was a continuum between humans and beasts and that different barbarian peoples could be placed on it; that deviance from human norms increased with distance from the Mediterranean heartlands. But these presuppositions were simply equivalent to the working hypotheses that ethnographers today take with them into the field, a clutch of ideas about incest, ancestor worship, animism, kinship, personhood, gift exchange and the like. On the middle ground these general principles are brought into relation with what is heard and seen in a creative project to which questioner and respondent both contribute. Like modern ethnographers, in other words, ancient writers never came entirely fresh to their subject. Previous writings formed one part of their baggage, but a set of analytical procedures and assumptions were also important. Yet these did not wholly determine the final version, any more than that final version was simply a record of local knowledge. Asclepiades, Tacitus and their analogues, conversing with Cruptorix and his kind, created the new story together.

My central claim has been that ethnographic knowledge was created on the middle ground. The alternative views propose either that ethnographic texts were essentially esoteric products of internal Greek and Roman discourse, owing little and mattering less to the peoples described, or else that they were largely disinterested records of genuinely ancient traditions derived from pristine indigenous cultures and merely transcribed at the point of contact, just another variety of exotic goods bartered on the river bank. My contention is that the form of the texts we have, together with what we know of frontier relations, make it much more likely that what we have are products of the middle ground. This has been rightly termed a process of ethnogenesis.⁴² My concern here has been to explore the modalities of that process, and ask what each side brought to the encounter. The actual texts generated were probably the least important product at the time. Myths were also rehearsed in cult and ritual. The longer term significance of the creation of texts like the *Germania* was, of course, enormous, but that is, as they say, another story. Listening in, however, on the conversations that must lie behind these literary products gives us a different sense of what 'Romans and natives' actually felt like at the edge of empire. In the long intervals between the crises that attracted the attention of classical historians, we can just hear the echo of conversations on the middle ground in which representatives of different worlds meet to seek some common understanding of the new one that they shared.

REFERENCES

- Batty, R., 2000: Mela's Phoenician Geography, *Journal of Roman Studies* 90, 70-94.
Bayly, C.A., 1996: *Empire and Information. Intelligence gathering and social communication in India, 1780-1870*, Cambridge.
Bazelmans, J., 1991: Conceptualizing early Germanic political structure. A review of the use of the concept of *Gefolgschaft*, in N. Roymans/F.Theuws (eds), 91-129.
Bickermann, E., 1952: *Origines gentium*, *Classical Philology* 47, 65-81.
Bishop, M.C./ J.C.N. Coulston, 1995: *Roman Military Equipment from the Punic Wars to the fall of Rome*, London.

⁴² Roymans 2004, setting these processes in different, but complementary contexts.

- Bohannon, L., 1952: A genealogical charter, *Africa* 22, 301-315.
- Bowman, A.K./ J.D.Thomas, 1994: *The Vindolanda Writing Tablets (Tabulae Vindolandenses II)*, London.
- Brandt, R./J. Slofstra (eds), 1983: *Roman and native in the Low Countries. Spheres of interaction*, Oxford (British Archaeological Reports, International Series 184).
- Cartledge, P.A., 1993: *The Greeks. A portrait of self and other*, Cambridge.
- Clifford, J./ G. E. Marcus (eds), 1986: *Writing Culture. The Poetics and Politics of Ethnography*, Berkeley CA.
- Clifford, J., 1999: *Routes. Travel and translation in the late twentieth century*, Cambridge.
- Creighton, J.S., 2000: *Coins and Power in late Iron Age Britain*, Cambridge.
- Dench, E., 1995: *From Barbarians to New Men. Greek, Roman and Modern Perceptions of Peoples from Central Appenines*, Oxford.
- Dueck, D., 2000: *Strabo of Amasia. A Greek man of letters in Augustan Rome*, London.
- Erskine, A., 2001: *Troy between Greece and Rome. Local tradition and imperial power*, Oxford.
- Fulford, M.G., 1985: Roman material in barbarian society, c.200 BC - AD 400, in T.C.Champion/ J.V.S.Megaw (eds), *Settlement and Society. Aspects of West European prehistory in the first millenium BC*, Leicester, 91-108.
- Gosden, C., 2004: *Archaeology and colonialism. Cultural contact from 5000 BC to the Present*, Cambridge.
- Hall, E. 1989: *Inventing the Barbarian. Greek self-definition through tragedy*, Oxford.
- Hall, J. M., 1997: *Ethnic identity in Greek antiquity*, Cambridge.
- Harrison, T.E.H. (ed.), 2002: *Greeks and Barbarians*, Edinburgh.
- Hartog, F., 1988: *The Mirror of Herodotus. The representation of the other in the writing of history*, Berkeley (French original 1980).
- Hedeager, L., 1987: Empire, frontier and the barbarian hinterland: Rome and northern Europe from A.D. 1 - 400, in M. Rowlands/M. Larsen/K. Kristiansen (eds), *Centre and Periphery in the Ancient World*, Cambridge, 125-140.
- Jacoby, F., 1923-1968: *Fragmente der Griechischen Historiker*, 14 volumes, Berlin/Leiden.
- MacKenzie, J. M., 1995: *Orientalism. History, theory and the arts*, Manchester/New York.
- Mócsy, A., 1983: The civilized Pannonians of Velleius, in B. Hartley/J. Wachter (eds), *Rome and her Northern Provinces. Papers presented to Sheppard Frere*, Gloucester, 169-178.
- Murphy, T., 2004: *Pliny the Elder's Natural History. The Empire in the Encyclopaedia*, Oxford.
- Nicolet, C., 1988: *L'inventaire du monde. Géographie et politique aux origines de l'Empire Romain*, Paris.
- O'Gorman, E., 1993: No place like Rome. Identity and difference in the *Germania* of Tacitus, *Ramus* 22, 135-154.
- Pitts, L.F., 1989: Relations between Rome and the German 'Kings' on the Middle Danube in the first to fourth centuries AD, *Journal of Roman Studies* 79, 45-58.
- Rawson, E., 1985: *Intellectual Life in the late Roman Republic*, London.
- Rives, J.B., 1999: *Tacitus Germania, translated with introduction and commentary*, Oxford.
- Romm, J.S., 1992: *The edges of the earth in ancient thought. Exploration, geography, fiction*, Princeton.
- Roymans, N. (ed.), 1996: *From the sword to the plough. Three studies on the earliest romanization in Belgic Gaul and the Rhineland area*, Amsterdam (Amsterdam Archaeological Studies 1).
- Roymans, N./ Theuws, F. (eds), 1991: *Images of the Past. Studies on Ancient Societies in northwestern Europe*, Amsterdam.
- Roymans, N., 2004: *Ethnic Identity and Imperial Power. The Batavians in the Roman Empire*, Amsterdam (Amsterdam Archaeological Studies 10).
- Said, E. W., 1978: *Orientalism*, London.
- Scheid, J., 1991: Sanctuaires et territoire dans la Colonia Augusta Treverorum, in J.-L. Brunaux (ed.), *Les sanctuaires celtiques et leurs rapports avec le monde méditerranéen. Actes du colloque de St-Riquier (8 au 11 novembre 1990)*, Paris, 42-57.
- Thomas, N., 1994: *Colonialism's culture. Anthropology, travel and government*, Cambridge.

- Thomas, R., 2000: *Herodotus in Context. Ethnography, science and the art of persuasion*, Cambridge.
- Van der Leeuw, S.E., 1983: Acculturation as information processing, in R. Brandt/J. Slofstra (eds), 11-38.
- Van Dommelen, P., 1998: *On colonial grounds. A comparative study of colonialism and rural settlement in first millennium BC west central Sardinia*, Leiden (Archaeological studies Leiden University 2).
- Washbrook, D.A., 1999: Orients and occidends. Colonial discourse theory and the historiography of the British Empire, in R.W.Winks (ed.), *The Oxford History of the British Empire* volume 5, *Historiography*, Oxford, 596-611.
- Webster, J., 1995: Translation and subjection. Interpretatio and the Celtic Gods, in J.D. Hill/C. Cumberpatch (eds), *Different Iron Ages. Studies on the Iron Age in Temperate Europe*, Oxford (British Archaeological Reports International Series 602), 175-183.
- White, R., 1991: *The middle ground. Indians, empires, and republics in the Great Lakes region, 1650-1815*, Cambridge.
- Whittaker, C.R., 1994: *Frontiers of the Roman Empire. A social and economic study*, Baltimore/London.
- Wiseman, T.P., 1983: Domi nobiles and the Roman cultural élite, in M. Cébeillac-Gervasoni (ed.), *Les 'bourgeoisies' municipales italiennes aux IIe et Ier siècles av. J.-C.*, Paris/Naples, 299-307, reprinted in T.P. Wiseman, 1987: *Roman studies. Literary and historical*, Liverpool, 297-305.
- Wissowa, G., 1916-19: Interpretatio Romana. Römische Götter im Barbarenlande, *Archiv für Religionswissenschaft* 19, 1-49.
- Wolf, G.D., 1998: *Becoming Roman. The origins of provincial civilization in Gaul*, Cambridge.
- Wolf, G.D., 2000: Urbanization and its discontents in early Roman Gaul, in E. Fentress (ed.), *Romanization and the City. Creation, transformations and failures*. Proceedings of a conference held at the American Academy in Rome to celebrate the 50th anniversary of the excavations at Cosa, 14-16 May 1998, Portsmouth RI (*Journal of Roman Archaeology* supplement no.38), 115-132.

Hercules and the construction of a Batavian identity in the context of the Roman empire

Nico Roymans

- 1 Introduction. Myth, history and the construction of collective identities
- 2 Evidence for Trojan foundation myths in Gaul and Britain
- 3 Hercules as the first civiliser of the Germanic frontier
- 4 The cult of Hercules among the Batavians
- 5 The appeal of the Roman Hercules and the construction of a Batavian identity
- 6 The Hercules sanctuaries and their significance for the construction of a Batavian identity
- 7 On the Hercules cult in the other civitates of Lower Germany
- 8 Discussion

Abbreviations

References

I INTRODUCTION. MYTH, HISTORY AND THE CONSTRUCTION OF COLLECTIVE IDENTITIES

When studying romanisation processes, archaeologists have until recently focused their attention on socio-economic and political aspects of the integration of groups into the Roman empire.¹ In the past decade, however, the scope has broadened to include ideological dimensions of the integration process. Several recent studies have pointed to the significance of foundation myths in the creation and perpetuation of collective identities within the context of the empire. Ethnic group identity is based to a significant extent on the notion of a common past. Almost every community in antiquity had its foundation myth. Although these stories often served to legitimise the power positions of leading elites, their significance went far beyond that. They played a key role in the self-definition of ethnic communities, marking their place in the cosmos.² Foundation myths appear to be flexible creations that changed in response to changing historical constellations.

The historian Gehrke has recently analysed the relationship between myth, history and collective identity in ancient Greece.³ He emphasises that foundation myths do not derive their power and vitality simply from references to the past, but from their significance for the present and the future. Foundation myths usually define friendship or kinship relations with outside groups which are relevant for the present. They thus become a frame of reference for dealing with the present and the future, which places

¹ This paper was published earlier as one of the chapters of my book *Ethnic identity and imperial power. The Batavians in the early Roman empire* (Roymans 2004). While the text has only been slightly changed, notes and references have

been brought up to date. I thank Ton Derks for his critical remarks on an earlier draft of this paper.

² Hobsbawm/Ranger 1983.

³ Gehrke 2000; idem, this volume.

the modern concepts of myth, history and contemporary history on a single continuum.⁴ By means of creative adaptation, relationships and group identities from the present are projected back into the past to become part of the collective memory. Gehrke calls this ‘intentional history’ (*intentionale Geschichte*), in the sense that the past derives its relevance from its capacity to help form relationships in the present.

In this paper, I intend to focus on the significance of the cult of Hercules for Batavian integration into the Roman Empire. In so doing, I will build on recent discussions about the changing self-definition of Celto-Germanic groups following their incorporation into the empire. My central proposition is that ‘becoming Roman’ meant that groups had to redefine their identity and self-image – in short, to rewrite their history. Derks and Creighton have placed this topic on the research agenda of provincial Roman archaeology.⁵ They have pointed to the need of communities conquered by Rome to forge a link to Graeco-Roman mythology in the context of their political relationship with Rome. I intend to take up this insight and develop it for Lower Rhine groups, with a particular focus on the Batavians. How did the Batavians find their way into Roman mythology and what were their motives for doing so?

I am fully aware that in broaching this topic – the role of origin myths in the construction of new identities by provincial Roman groups – I am entering a terrain of meagre archaeological evidence and few historical sources. In fact, we have no direct historical information at all about Batavian descent myths. What we do have, however, is important circumstantial evidence, both historical and archaeological. By combining this knowledge with analogies with other groups in the northern provinces of the Roman Empire, we can put forward a model for developments among the Batavians. Although I realise that much of what I propose here is speculation, my reason for broaching this subject is that it constitutes a vital aspect of the romanisation of Lower Rhine groups, and one which we simply cannot ignore, especially if we hope to understand the self-image of groups vis-à-vis the Roman Empire.

The springboard for my analysis has been Derks’ recent study⁶ of Gallo-Roman religion and, in particular, the cult of indigenous deities associated with Mars or Hercules. The monumental character of the sanctuaries where these gods were worshipped, the involvement of magistrates in their cult and, most notably, a number of inscriptions linking their cult to a *civitas* or *pagus*, all provide strong evidence to suggest that they were the principal deities of *civitates* or *pagi*. Derks maintains that the various associations of indigenous gods with the Roman Mars or Hercules are not isolated instances, but rather core elements in the mythical anchoring of Celto-Germanic groups in the Roman world, and hence in the creation of a new historical self-image. We can observe two strands in the available evidence:

- a link to Trojan descent myths, frequently associated with Mars as the principal deity, discernible in various *civitates* in Gaul and possibly Britannia.
- a link to Hercules, documented only on the Lower Germanic frontier.

Before discussing the significance of the cult of Hercules among the Batavians, I will elaborate on both these links.

2 EVIDENCE FOR TROJAN FOUNDATION MYTHS IN GAUL AND BRITAIN

Although foundation myths were an important element in the symbolic construction of ethnic identities in the pre-Roman Celto-Germanic world, the information we have about them is meagre. The best-known example is the Mannus genealogy of Germanic groups, described by Tacitus, in which tribes traced back their origins to deities or mythical ancestors.⁷ Tacitus’ observation that different versions

⁴ Gehrke 2000, 9.

⁶ Derks 1998, 91 ff.

⁵ Derks 1998; Creighton 2000.

⁷ Tacitus, *Germ.* 2.

of the genealogy were in circulation points to the myth's dynamic character. Collective descent myths continued to play a fundamental role in the self-definition of provincial Roman groups, who, above all else, did not wish to be associated with the barbarians whom Rome had defeated. By creatively adapting foundation myths and genealogies, they sought to negotiate for themselves a worthy place in the Roman world. The myths were a declaration of political loyalty to the new regime. The following examples from Gaul and Britain demonstrate the creative appropriation of a Trojan foundation myth:⁸

- a. Arverni. The poet Lucan reported in the mid-1st century AD that the Arverni claimed Trojan descent and hence kinship ties with Rome.⁹ His words – that the Arverni ‘dared’ to represent themselves in this way – suggest that Rome did not officially recognise their prestigious foundation myth. This descent tradition, probably created in the 2nd century BC as a result of an alliance with Rome, was still referred to in the 5th century AD by Bishop Sidonius Apollinaris.¹⁰
- b. Aedui. Caesar reported that the Aedui were allies of Rome, whom the senate officially honoured with the title ‘brothers and kinsmen’ (*fratres consanguineique*).¹¹ This would suggest that, like their neighbours the Arverni, the Aedui claimed Trojan descent.¹² The alliance with Rome, and probably the notion of a common Trojan origin, dates back to the 2nd century BC.¹³ The kinship tie with Rome was still referred to in the 4th century AD. It appears that the Aedui worshipped Mars as their principal deity.
- c. Remi. The Remi also seem to have claimed kinship ties with Rome. Mars Camulus, the principal deity of the Remi, may have been an important unifying element. A central clue is the interpretation of the sculptural programme on the monumental triple arch of the ‘Porta Martis’, at Reims.¹⁴ This is believed to represent the foundation myths of both Rome and the Remi. Mars, the god who gave the arch its name, is the principal figure on the central arch. The other arches depict Romulus and Remus, and Leda and the swan, while the arch facades include statues of Venus and Aeneas, and Rhea Silvia and Mars, four leading figures in the foundation myth of Rome. A votive inscription from Reims, dedicated to Mars Camulus, also hints at a direct link to Roman foundation myths. The dedicant, whose name is clearly a provincial one, was a member of the Laurentes Lavinates, an elite college of priests from Italy who had a specific responsibility for the cult surrounding the Trojan foundation myth of Rome.¹⁵ The name of the Remi may have contributed to the interweaving of their foundation myth with that of Rome. It enabled them to trace their origin to an eponymous forefather, Remus, immediately evoking associations with Romulus’ twin brother of the same name, the founder of Rome.¹⁶
- d. Britannia. Various medieval texts provide evidence of a Trojan foundation myth for Britain. At their heart is the Brutus story. Aeneas’ grandson, Silvius, had a secret love affair, out of which Brutus was born. Fate decreed that he should cause the death of both his mother and father. His relatives banished him from Italy and, after much wandering, he arrived in Britain, where successive generations of his descendants ruled until Julius Caesar reunited them with their noble origins.¹⁷ Although the earliest version of this medieval tale dates to c. 800 AD, Creighton believes it may have been of Roman origin, partly in view of the overwhelming evidence for the appropriation of Graeco-Roman myth by British rulers in the era before the Claudian conquest.¹⁸

⁸ Derks 1998, 108–111.

⁹ Lucanus, *Phars.* I, 427–428. Cf. Braund 1980; Goudineau/Peyre 1993, 171.

¹⁰ Sidonius Apollinaris, *Carmina* 7.139; *Epistulae* 7.7.2.

¹¹ Caesar, *BG* 1,33.

¹² Goudineau/Peyre 1993, 172–173.

¹³ Goudineau/Peyre 1993, 171–172.

¹⁴ Derks 1998, 106 ff.; *ibid* 1999, 357–358.

¹⁵ Derks 1998, 109–110.

¹⁶ Derks 1998, 108–109. Flodoard, the early medieval ecclesiastical historian, saw a connection between Remus and the foundation myth of the Remi.

¹⁷ Creighton 2000, 140.

¹⁸ Creighton 2000, 141 ff.

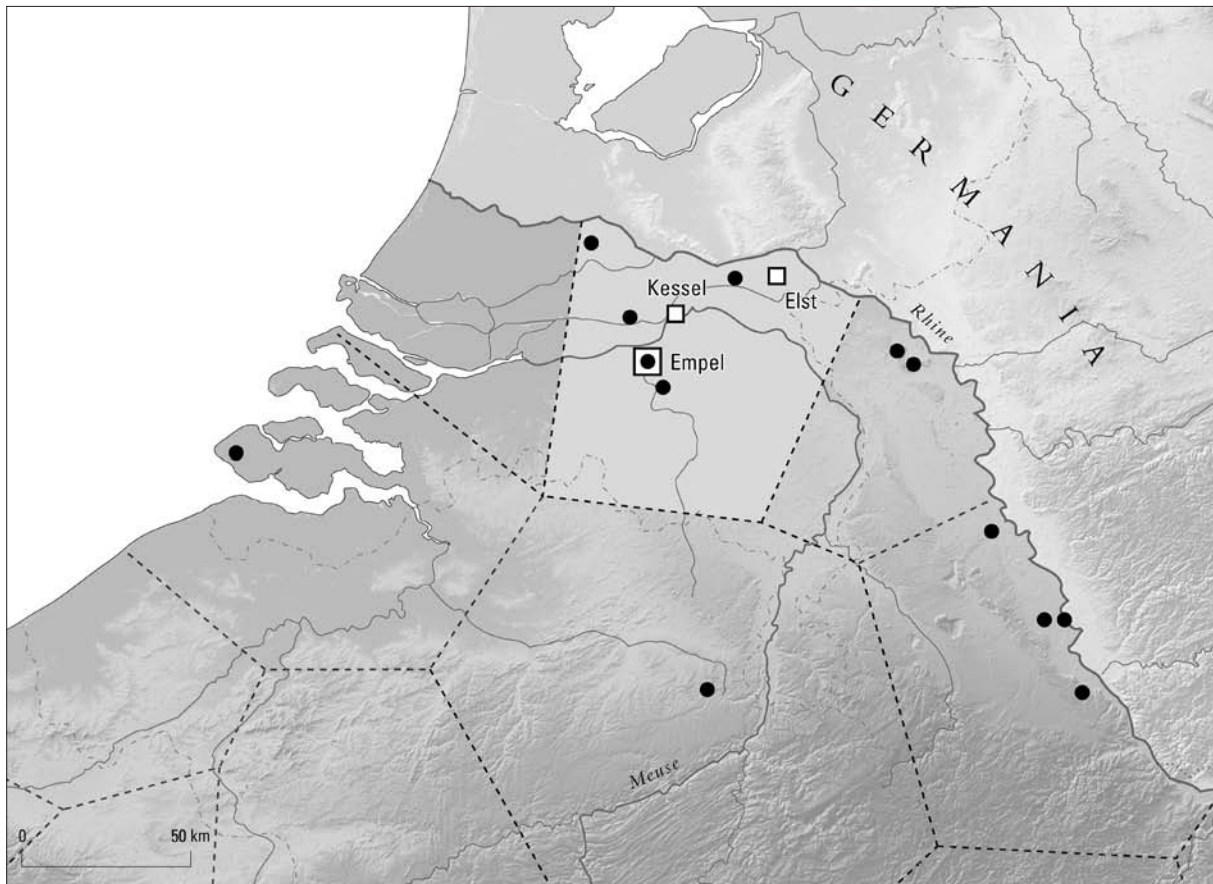

Fig. 1. Distribution of votive inscriptions to Hercules Magusanus (black dots), and of public sanctuaries (squares) certainly (Empel) or probably (Elst, Kessel) dedicated to him in the Lower Rhine region.

The above examples demonstrate how deeply rooted was the Trojan descent myth in the northwestern provinces. The earliest associations date from the 2nd century BC among peoples in Central/Eastern Gaul who already then maintained treaty relations with Rome. Later, Augustus may have provided a powerful impetus. At his instigation, literary circles made modifications to the foundation myth of Rome; the Julian family of his adoptive father Caesar was positioned at the heart of the myth by claiming descent from Venus and Aeneas.¹⁹ As the father of Romulus and hence the founder of Rome, Mars had been a central figure in the Roman foundation myth from early times. Trojan foundation myths long retained their popularity in Gaul, enabling us to trace the tradition among the Aedui and the Arverni right up until the 4th/5th century. It is interesting to note that the Merovingian kings also laid claim to Trojan descent. By appropriating the foundation myth of Rome, they were able to present themselves as Rome's successors. Probably they were linking themselves to the then still widespread descent tradition of Rome and of many Gallic communities.²⁰

One feature of the Gallic examples is the connection with a local cult of Mars. This does not appear to have been coincidental; rather, it fitted within the ideological programme propagated by Augustus. The question we must ask is how close was this association? Should we assume a link with the Roman descent myth in all *civitates* where Mars was the principal deity? Derks believes that we should. He suggests that

¹⁹ Cf. in particular the sculptural design in the decoration of the Mars temple at the Forum of Augustus in Rome.

See Derks 1998, 30 ff.

²⁰ Barlow 1995.

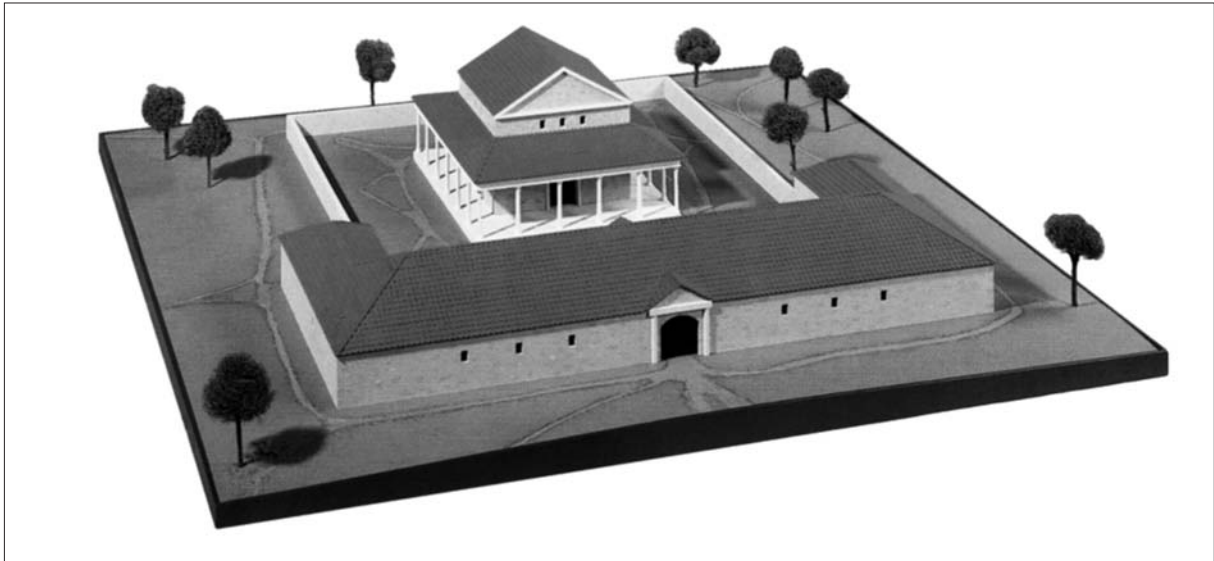

Fig. 2. Reconstruction of the Gallo-Roman temple complex at Empel. Photo Noordbrabants Museum, 's-Hertogenbosch.

the choice of Mars went hand in hand with the incorporation of Rome's legendary past into that of the local community.²¹ The choice of Mars can be seen as a declaration of loyalty to the Augustan political order. It is important to emphasise that the Gallic Mars deities are all syncretisms, in which a local – probably pre-Roman – god is equated with the Roman Mars. Such syncretisms enabled communities to create a new kinship bond with Rome, while at the same time preserving their local identity.

3 HERCULES AS THE FIRST CIVILISER OF THE GERMANIC FRONTIER

Alongside the Trojan origin myth there is a second, much less widespread myth, which is based on descent from Hercules. This tradition is directly linked to Roman myths about Hercules' exploits in the barbarian north. In Graeco-Roman mythology, Hercules is the prime example of an adventurer who constantly traverses the frontiers of the civilised world. In his adventurous exploits in the world beyond the frontier, he comes face to face with barbaric hostile forces in a wild and inhospitable natural environment. He is credited with being the first explorer and civiliser of the barbarian frontier regions, initially in Spain and Africa, and later in Gaul and Germania.²² The earliest diffusion of Herculean myth accompanied the wave of colonisation by Greek states that swept across the western Mediterranean.²³ Later, Hercules' advance went hand in hand with Roman expansion in Gaul. As the boundaries of the Roman frontier shifted, so too did Hercules. Diodorus' account of Hercules' exploits in Gaul is an illustration of this. Hercules pacified and offered protection from perils in regions where nature was as yet untamed and where barbaric customs still prevailed, clearing a safe passage into wild areas and protecting those who took possession of these regions in his wake.²⁴ Thus Diodorus links Hercules to Roman expansion, with

²¹ Derks 1998, 101.

²² For geographical shifts in Hercules myths over time, see Jourdain-Annequin 1992; Plácido 1993.

²³ For a brief chronological survey of passages on Hercules'

actions in Gaul in the Graeco-Roman literature, see Moitrieux 2002, 69-72.

²⁴ Diodorus, *Bibliothèque* 4,19,1 and 4. Cf. Jourdain-Annequin 1992, 278.

Hercules paving the way for Caesar's legions. Hercules became the perfect embodiment of the war against the Barbarians, waged in the name of civilisation; he provided a justification for the Greek wave of colonisation and, later, for Roman military expansion.²⁵

We should therefore not be surprised at Hercules' appearance, with similar associations, at the Germanic frontier several generations later. According to Tacitus, Hercules' travels also took him to Germania, where people praised him as their supreme hero.²⁶ Elsewhere Tacitus reports on the Pillars of Hercules in the Frisian area on the North Sea coast.²⁷ Such references to Herculean myths primarily reflect a Roman perspective, and can probably be traced back to creations by Roman soldiers who were active in Germania. The central theme is that Hercules had preceded the Roman armies in exploring and socialising the Germanic frontier.²⁸

In the Graeco-Roman world, Hercules played a prominent role in the origin myths of local royal lineages. According to the standard pattern, Hercules would sire a son by the daughter of a local king, and the son would subsequently become eponymous for a city or primogenitor of a people.²⁹ It is precisely this theme that allowed groups at the barbarian frontier to creatively appropriate Herculean myths, thus taking up the Graeco-Roman myths about Hercules' exploits among barbarian peoples. One early example dating back to the 5th century BC is a



Fig. 3. Bronze Hercules figurine from Empel (1st century AD). After Roymans/Derks 1994.

²⁵ Jourdain-Annequin 1992, 278; Webster 1994.

²⁶ Tacitus, *Germ.* 3.

²⁷ Tacitus, *Germ.* 34. Tacitus reveals that he was aware of the dynamic nature of this myth; the location of the Pillars of Hercules moved from the Straits of Gibraltar to the North Sea coast.

²⁸ Cf. also the place name *Castra Herculis*, situated along the Lower Rhine and mentioned on the Peutinger Map. The name of this Roman fort may well refer to a foundation myth by Hercules, generated by the Roman soldiers who first built the camp. *Castra Herculis* has been identified with the fort at Arnhem–Meinerswijk, the foundation of which is related to the campaigns of Germanicus between AD 14 and 16 (Willems 1986). Cf. Tacitus' story (*Germ.* 3) about the Greek hero Odysseus, who is said to have stopped in Germania on his northern travels. There

he founded Asciburgium, and there is even a report of an altar dedicated to him. This myth, too, seems to be a product of Roman soldiers stationed in the army camp at Asciburgium.

²⁹ Cf. *DNP* 5, 1998, 387–392 s.v. Herakles [Fritz Graf]; 403–404 s.v. Hercules [A. Mastrocinque] (with further references); Huttner 1977, esp. 225–229. Hercules may also have played a role in the earliest foundation myth of Rome. In his recent book, *Erocle e Roma*, Mario Levi emphasises the significance of the Hercules cult at the Forum Boarium for early (pre-Hellenistic) Rome, and sees in him the true founder (*vero ecista*) of Rome (Levi 1997, 9). According to him, the classical foundation myth of Rome (including the link with the Trojan cycle) represents a more recent version, which did not emerge until the Hellenistic period (*idem*, 25).

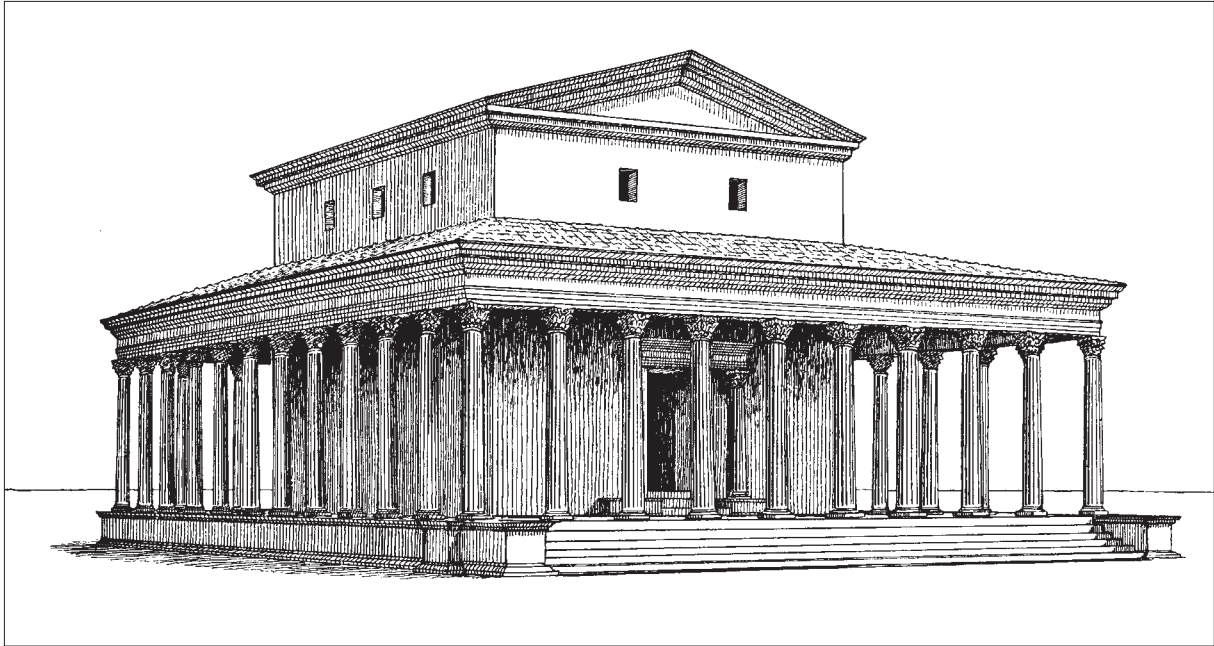

Fig. 4. Reconstruction of the Gallo-Roman temple of Elst-‘Maartensstraat’. After Bogaers 1955, pl. 45.

Scythian origin myth, recounted by Herodotus. During his travels through the land of the Scythians with Geryones’ cattle, Hercules encountered a maiden – half woman, half snake – by whom he sired three sons. Scythes, the youngest, became the forefather of the Scythian kings.³⁰ Later, similar myths appear to have been created by Gallic groups. Diodorus reports (probably following Posidonius) on the reputed descent of the Celts from Hercules, who was said to have visited Celtica during his campaigns against Geryones and to have sired a son, named Galates, by the daughter of a local king.³¹ It is this Galates to whom the Gauls owe their name. Diodorus also tells of Hercules founding the city of Alesia.³² Like the Trojan descent traditions of Gallic groups, these Herculean descent myths of ‘barbaric’ peoples will not have been externally imposed by the Greeks or by Rome. Rather, they express the viewpoint of local aristocrats, who used the creative appropriations of Mediterranean Hercules myths to demonstrate their close political and cultural ties with Greek states, and later, with Rome.³³

³⁰ Herodotus, *Hist.* 4, 8-10. This myth was allegedly told in Greek cities on the Black Sea coast. It was probably created by Scythian leaders who had entered into alliances with Greek colonies and who may even have had residences there. Cf. in this regard Herodotus’ fascinating story of the Scythian king, Scylas, who lived in two separate worlds, a Greek and a Scythian one (*Hist.* 4, 78 ff).

³¹ Diodorus, *Bibliothèque* 5.24. For related myths, cf. also Parthenius, *Narrationes Amatoriae* 30; Dionysius of Halicarnassus, *Antiquitates Romanae* 14, 1, 3.

³² Diodorus, *Bibliothèque* 4.19.2.

³³ Cf. Lund 1998, 99 ff. In contrast with Webster (1994, 5-6), who views such origin myths too one-sidedly

as a Roman form of cultural imperialism, as part of a Roman colonial discourse imposed by Rome on Gallic groups. Relevant here is the rich numismatic evidence from Britannia, analysed by Creighton (2000). The coin series struck by British ‘client kings’ of Rome in the period before the Claudian conquest bears witness to an astonishingly rich knowledge of Graeco-Roman myth. Scheid (1999, 385) points out that in polytheistic religious systems (like the Graeco-Roman and Germano-Celtic religions) the adoption and worship of deities of other groups poses fewer problems than in monotheistic religions; we are dealing here with additive extensions of open systems.

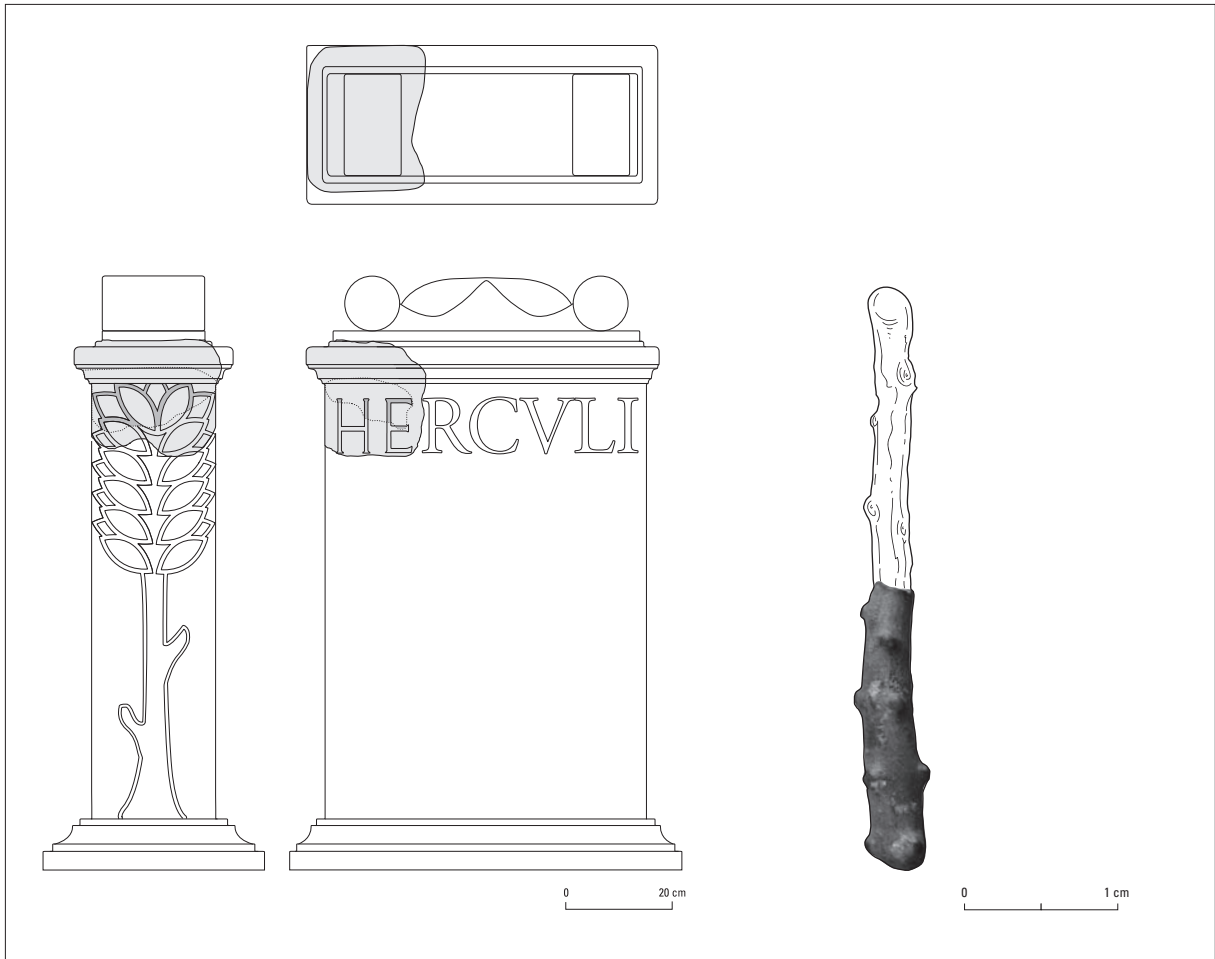

Fig. 5. Club of a bronze Hercules figurine and fragment of a c. 1 meter high votive altar dedicated to Hercules from Elst. After Derks *et al.* 2008, fig. 4.8 and 5.2.

It is important to note that the Hercules descent myths of the Gauls, reported by Diodorus and others, date from the period between Caesar's Gallic wars and the death of Augustus. There is no evidence to show that this myth retained its vitality in the imperial period, by which time Mars had become the principal deity of almost all *civitates*. This stresses the particular status of Hercules as a 'frontier deity'. After the provincialisation of Gaul and the introduction of a formal Roman *civitas* system under Augustus, Hercules seems to have lost his special appeal for the Gauls. He owed his initial popularity to his ambivalent nature: on the one hand a Roman god, on the other hand a deity with barbaric traits because of his martial and pastoral associations, his drinking habits and his nomadic life-style.

4 THE CULT OF HERCULES AMONG THE BATAVIANS

Derks and the present author have recently drawn attention to the special significance of the cult of Hercules among Lower Germanic groups along the Rhine and, in particular, the Batavians.³⁴ This is an instance of the appropriation by indigenous groups of the Roman Hercules cult, probably tying in with Roman myths about the role of Hercules as the first explorer of the Celto-Germanic frontier.

³⁴ Roymans 1996, 88-94; Derks 1998, 98, 111 ff.

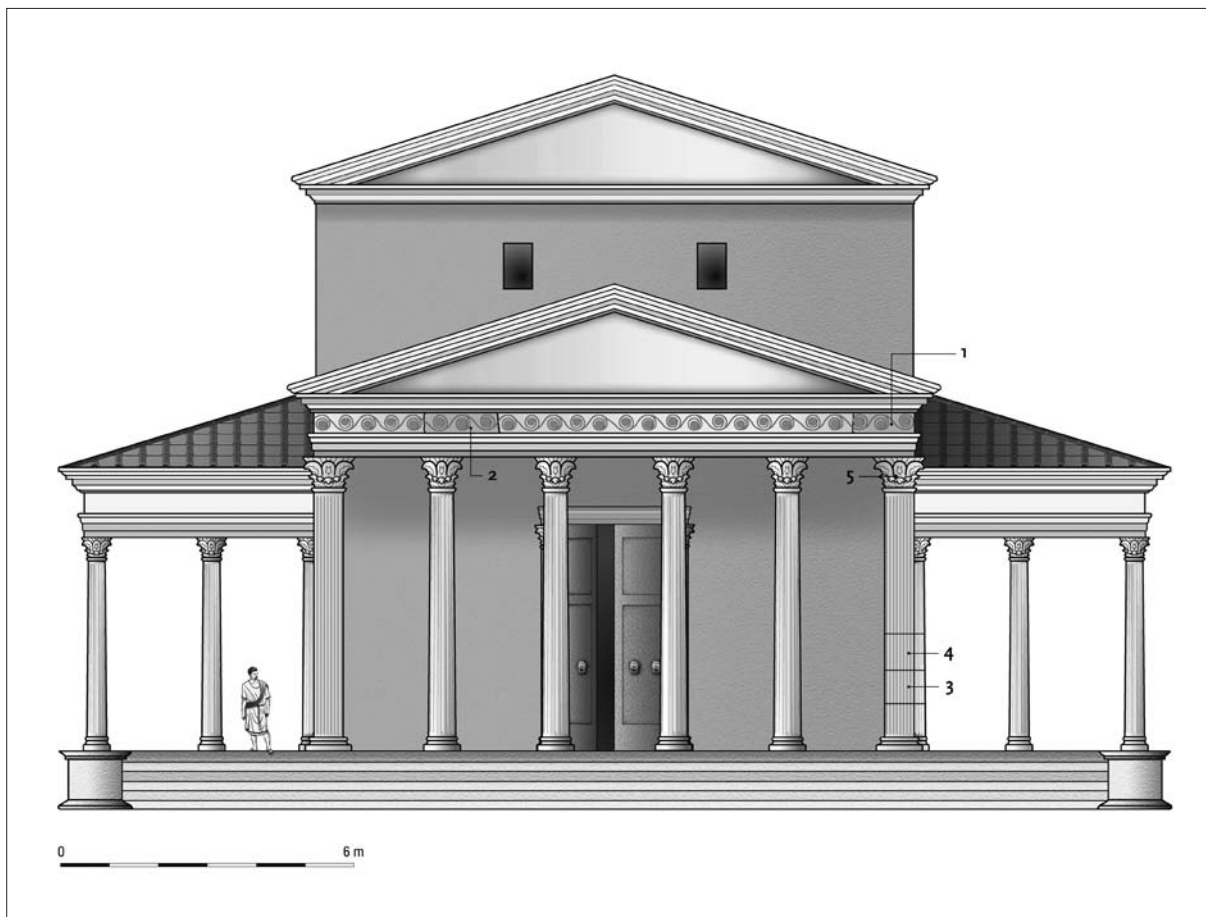

Fig. 6. Attempted reconstruction of the Gallo-Roman temple at Kessel. The numbering refers to architectural remains retrieved during the excavation. After Roymans 2004, fig. 7.23.

Significant here is the epigraphic evidence for the cult of Hercules Magusanus. Hercules Magusanus is a god with a double name, a Roman and an indigenous one respectively, and we should regard him as a syncretism of the Roman Hercules with Magusanus, a local deity or hero.³⁵ The cult was based in Germania Inferior, particularly the Batavian region, as attested to by the distribution of votive inscriptions and the presence of some monumental sanctuaries that can be ascribed to this deity (fig. 1). Hercules Magusanus may well have been the principal deity of the *civitas* of the Batavians.³⁶

From the Batavian area we now know of three cult places which have produced evidence for an association with Hercules. Firstly, the Gallo-Roman sanctuary at Empel (fig. 2); among the find material there are many pieces of military equipment, a bronze figurine of Hercules (fig. 3) and a votive inscription to Hercules Magusanus.³⁷ Secondly, the Gallo-Roman temple at Elst (fig. 4). Bogaers' hypothetical association of this sanctuary with Hercules Magusanus seems to be confirmed by the recent find of a

³⁵ The sequence is reversed – Magusanus Hercules – in the oldest inscription from Ruimel (*CIL* XIII 8771; first half 1st century AD). Hercules Magusanus is the only example of an 'indigenous' Hercules north of the Alps. Cf. Moitrioux 2002, 181 ff.

³⁶ This is evident from the relatively large numbers of

votive inscriptions from the Batavian area (fig. 1), the association of the cult with the monumental temple complex at Empel and probably also Elst and Kessel, and the presence among the dedicants of a *summus magistratus* of the *civitas Batavorum* (*CIL* XIII 8771).

³⁷ Roymans/Derks 1994.

fragment of a bronze figurine of Hercules, and a fragment of a votive altar dedicated to Hercules, found on an adjacent rural settlement (fig. 5).³⁸ Thirdly, a cult place discovered during large-scale dredging operations at Kessel/Lith on the south bank of the Meuse. Here, a large ritual find complex was encountered with Late La Tène and early-Roman military equipment, human and animal bones and pottery. The same site also produced rich decorative building remains of a monumental Gallo-Roman temple (fig. 6) used as spolia in a Late Roman fortification. The strong military association of the cult place points to Hercules as the central deity worshipped here.³⁹

Recent investigations of the monumental cult places dedicated to Hercules Magusanus in the Batavian area have added substantially to our knowledge of the cult of this deity. Most striking are the strong masculine and military associations of the cult, as evidenced in the ritual deposition of many kinds of weaponry. Another notable feature is the pre-Roman origin of the sanctuaries.

Although no historical evidence has been passed down to us about the myths involving Hercules Magusanus, we note that the iconography relating to him is fully in keeping with that of the Roman Hercules, including references to the mythical repertoires associated with him. A bronze figurine from Empel (1st century AD; fig. 3) shows him wearing a lion's skin over his shoulders, holding a club (now lost) in his left hand and a drinking cup in his right. On an altar stone from Bonn (226 AD; fig. 7), he once again bears a club and lion's skin, and is flanked by Cerberus, the hellhound. And a statue from Xanten (2nd/3rd century AD; fig. 8) shows him in classical pose holding a club and, in his left hand, the apples of the Hesperides. All this would suggest that, although Hercules Magusanus may have expressed a local individuality and identity in terms of his name, he was quickly perceived – certainly by outsiders – as a truly Roman Hercules.⁴⁰

For the Batavians, we have no specific information about just how the Roman Hercules was integrated into local foundation myths. Analogies, however, allow us to proffer some suggestions. The same leitmotif that we encounter elsewhere in Herculean myths may have applied to Hercules Magusanus as well. During his travels with the cattle of Geryones, Hercules passed through the Batavian region,



Fig. 7. Altar stone for Hercules Magusanus from Bonn, dated 226 AD. After Horn 1970, Abb. 1.

³⁸ Bogaers 1955, 173, 240; Derks *et al.* 2008, 77, fig. 4.8, 138 ff, fig. 5.2.

³⁹ Roymans 2004, chapter 7.6.

⁴⁰ Derks 1998, 113-115. This may explain why the dedi-

cants of votive altars to Hercules Magusanus include several persons who did not come from the Lower Rhine area.



Fig. 8. Stone statue of Hercules Magusanus from Xanten (2nd/3rd century AD), dedicated by a Roman legionary soldier (CIL XIII 8610). Photo Ton Derks.

where he is said to have sired a child by a local progenitress, thus entering into existing descent myths. However, as with the local Mars gods in Gaul, the situation with regard to Hercules Magusanus is more complex in that it involves a syncretism. Here we must take account of an existing deity or hero who already occupied a place in the pantheon, who shared several structural similarities with Hercules and who was identified with him.

Who among the Batavians could have been responsible for appropriating the myth of Hercules and fusing it with the already existing Magusanus myth? The originators must be sought first and foremost among those with access to political power: the pro-Roman Batavian elite, and the group of the *Iulii* in particular. In their youth, members of the *stirps regia* may have enjoyed a Roman education as ‘hostages’ in centres in Italy or in the province (fig. 9), and may have used the knowledge gained there to create new interpretations and appropriations of Graeco-Roman myth.⁴¹ Relevant here is the analogy with events in Britannia where, until the time of the Claudian conquest, British rulers enjoyed considerable autonomy as client kings of Rome. We know of coins from British rulers that either depicted Hercules or presented the rulers themselves as Hercules.⁴² These representations demonstrate the personal preferences of British kings, probably arising from knowledge acquired

during their education in Italy. However, the elite cannot have been solely responsible for the success of the Lower Rhine Hercules cult. Although they probably made the initial association, this does not account for its general popularity. To become a common good, a new idea has to be accepted across all levels of society; it must be positively received or ‘believed’ by the broad masses. It would appear that the association of Magusanus with Hercules rapidly gained wide acceptance. Heroic Herculean legends probably merged

⁴¹ Taking and ‘raising’ children of the leading indigenous aristocracy as hostages or prisoners was a known Roman strategy for controlling groups in the Gallic and Germanic frontier (Wolters 1990, 87, 216; idem 2000, 37; Creighton 2000, 137; Allen 2006). As an illustration, we should examine the situation among the *stirps regia* of the Cherusci who, on the eve of the revolt under Arminius, were the main ally of Rome in the area between the Lower Rhine and the Elbe (Wolters 1990, 211–212). Arminius’ son was a prisoner/hostage in Roman hands

(Tacitus, *Ann.* 2.10), and his brother’s son (Flavus and Italicus respectively) was born in Rome. After being raised in Italy, Italicus was sent back under Claudius to his homeland, where he was appointed king (Tacitus, *Ann.* 11.16). The Augustan denarius *RIC* I 201a (fig. 9) makes a direct reference to the practice of taking hostages. The reverse side shows a barbarian in Germanic dress who, as a sign of subjection, hands over a child as hostage to emperor Augustus (cf. Wolters 2000, 37).

⁴² Creighton 2000, 179, 182.



Fig. 9. Augustan *denarius* (RIC I 201a). The reverse shows a barbarian in Germanic dress who, as a sign of subjection, hands over a child as hostage to emperor Augustus. After Zieghaus 2000, Abb. 15.1.

with those of Magusanus and soon became an integral part of the collective memory of the Batavian community. This will have happened in one or two generations, probably in the Augustan era.⁴³

The gradual introduction of the Roman *civitas* system from Drusus onwards and the later legal elevation of Noviomagus to the status of *municipium* around 100 under Trajan⁴⁴ undoubtedly led to changes in the nature and organisation of the public cult. However, since there was no question here of large-scale settlement by foreign Roman veterans, we should assume a considerable degree of continuity in broad terms. Against this background, we can understand that the *civitas Batavorum* continued to adhere to the mythically-based Hercules tradition, as is evidenced by the impressive monumentalisation of the sanctuaries of Elst, Empel and Kessel around AD 100.

5 THE APPEAL OF THE ROMAN HERCULES AND THE CONSTRUCTION OF A BATAVIAN IDENTITY

The Batavian Hercules cult should be seen in the context of a special alliance with Rome during the early imperial period. Tacitus speaks of an *antiqua societas*, which may have had its roots in the Caesarian organisation of the Rhine frontier.⁴⁵ As a consequence, the Batavians still enjoyed special privileges in the Neronian period, in particular exemption from paying tribute and the right to supply auxiliary troops in closed ethnic units, led by their own commanders. The size of the auxiliary units supplied to Rome was quite exceptional: in the pre-Flavian era, about 5000 soldiers spread across ten units.⁴⁶ The alliance with Rome was closely

⁴³ A *terminus ante quem* is provided by the above-mentioned altar stone from Ruimel, which is dedicated to Magusanus Hercules and which can be dated to the early 1st century AD. The fact that the dedication was carried out by a *summus magistratus* of the Batavian *civitas* means that the Hercules cult had already developed into a public cult at that time. It had probably begun as the private creation of members of the Batavian elite.

⁴⁴ Cf. Haalebos 2000, 38. An additional argument is provided by the new dendrochronological dating of the construction of the Gallo-Roman temple at Elst-St. Maartenstraat around AD 100 (Derks *et. al.* 2008, 33 ff, 136 ff.).

⁴⁵ Roymans 2004, chapter 5.

⁴⁶ Roymans 1996, 23–24, fig. 4, with further references.

tied up with the power position of the Batavian aristocracy, who had acquired Roman citizenship; the most prominent of them belonged to the *stirps regia*, of which Julius Civilis was a member.

So what was the attraction of the Roman cult of Hercules for Germanic groups in the Lower Rhine, and for Batavians in particular? It has been argued that the Roman Hercules represented ideas and values which had particular appeal for Lower Rhine groups and which matched those associated with their local deity or hero, Magusanus.⁴⁷

These were first and foremost martial values. In the Graeco-Roman world, Hercules stood for masculine power and courage, as epithets such as Hercules Victor and Hercules Invictus demonstrate. These martial qualities had particular appeal for Germanic groups. Tacitus reports that Hercules' heroic deeds made him a shining example to Germanic warriors.⁴⁸ In addition, a large proportion of the votive inscriptions to Hercules Magusanus were from soldiers or veterans. Further evidence of martial associations is the practice of depositing weapons in the sanctuary of Hercules Magusanus at Empel.

Secondly, Hercules' popularity will have been influenced by the pastoral values associated with him. Unlike Mars, Hercules had a reputation as a keeper and protector of cattle, thus providing a link to the livelihood of indigenous groups in the Lower Rhine area. The Rhine delta – probably the centre of the Hercules Magusanus cult – was essentially a non-villa landscape in which the agrarian economy relied heavily on cattle and horse raising. Also interesting is the association of the Mediterranean Hercules with the theme of cattle raiding. Traditionally, cattle raids may have been the social context par excellence in which Lower Rhine groups could display both martial and pastoral values.⁴⁹

A third factor accounting for Hercules' appeal was his role as mediator, as an intermediary deity who bridged the gap between Germanic groups and Roman civilisation, thus securing for the former a respectable place in the Roman world. This theme builds on Hercules' role as the first explorer of the Germanic frontier and, by virtue of his sexual escapades, as the mythical forebear of barbarian peoples. This bridging function was particularly relevant for Germanic groups, who continued to be stigmatised as barbarians by the Romans, particularly after the failure of the Augustan *Germania* policy.

This last point brings us to the ethnic self-definition, or self-image, of Lower Rhine groups vis-à-vis Rome and to the role of the Hercules myth. Two attributes, to some degree at odds with one another, may have dominated the collective self-image of the Batavians in relation to the Romans. On the one hand, there was their status as a worthy treaty partner of Rome. Certainly, their prestigious role as the supplier of elite troops and the bodyguard of the Julian-Claudian emperors will have added to their self-respect. On the other hand, there was the problem of their barbarian status. In Roman eyes, the Batavians were Germanic, and hence barbarians.⁵⁰ Tacitus' account of the Batavian revolt illustrates how easily the old barbarian clichés were reactivated in a time of crisis.⁵¹ Challenging their barbarian stigma must therefore have been a point of emphasis in the Batavian self-image. In the 1st century AD, the Batavians laid claim to a position within the Roman Empire, as shown by the votive stone from Ruimel, the triumphal pillar for Tiberius from Nijmegen,⁵² the construction of monumental temples and the fact that the upper-most Batavian elite enjoyed Roman citizenship. These were means by which they emphasised an inclusive Roman identity. The Batavian Hercules myth, too, cannot be viewed separately from the political relationship with Rome at the time: it was probably an essential component of Batavian 'intentional history', a mythical variant of the alliance with Rome.

⁴⁷ Cf. Roymans 1996, 88 ff., and Derks 1998, 102 ff., for the pastoral and martial associations of the Lower Rhine Hercules.

⁴⁸ Tacitus, *Germ.* 3.

⁴⁹ Roymans 1996, 88 ff.

⁵⁰ Cf. the discussion in Roymans 2004, chapter 10.3.

⁵¹ Tacitus reduces the conflict to a struggle between Romans and barbarians; the Romans strongly suspected Julius Civilis of striving for an independent *regnum Germanorum*, which would pose a serious threat to the Gallic provinces. Cf. Tacitus, *Hist.* 4.18; 4.73.

⁵² Panhuysen 2002; Roymans 2004, 216.

6 THE HERCULES SANCTUARIES AND THEIR SIGNIFICANCE FOR THE CONSTRUCTION OF A BATAVIAN IDENTITY

Generally speaking, public cult places played a vital role in the symbolic construction of ethnic communities and the creation of boundaries with outside groups.⁵³ They often functioned as *lieux de mémoire* where foundation myths were reproduced through rituals, cult celebrations, imagery, etc. At appointed times people would gather in large numbers to affirm themselves as a cult community. The role of public sanctuaries as key locations for creating a collective identity is graphically illustrated in Tacitus' account of the central cult place of the Germanic Suebi, where the tribe gathered each year to commemorate its origins (*initia gentis*):

*They describe the Semnonnes as the most ancient and best-born of the Suebi. This credibility of their antiquity is confirmed by religion. At fixed seasons all tribes of the same name and blood gather through their delegations at a certain forest, (...). And after publicly offering up a human life, they celebrate the grim initiation of their barbarous worship (...). The whole superstition came to this, that it was here where the race arose, here where dwells the god who is lord of all things.*⁵⁴

As argued above, Hercules will have played a prominent role in the *initia gentis* of the Batavians, and it therefore seems likely that the Hercules sanctuaries at Empel, Elst and Kessel were focal points where the Batavian origin myth was commemorated and where a collective identity was forged. These cult places may have had links to the mythical biography of Hercules Magusanus, perhaps as a place where he had once come to make a sacrifice.⁵⁵

Recent archaeological investigations in the sanctuaries of Empel and Elst have produced extensive evidence for the practice of ritual feasting. The pottery spectrum at Empel is dominated by drinking ware and kitchen pottery, which are related to the preparation and consumption of food and drink during religious festivities. The bone material is heavily dominated by cattle, which were slaughtered and consumed at the cult sites on a massive scale.⁵⁶ This ritual feasting in public cult places was an important means of social interaction in early Batavian society. Powerful networks were sustained by collective food and drink rituals, and they probably constituted a major means of defining membership of the Batavian community.

The significance of the Batavian Hercules sanctuaries was certainly not confined solely to the creation of an ethnic identity, but also extended to the construction of gender and age-class identities. The excavations at Empel have furnished us with archaeological evidence of this. Inasmuch as we are able to make sex specifications, the ritual find complex discovered here is strikingly male in character. This is particularly evident in the many remains of weapons and horse gear. Find categories that point clearly to the female domain (certain fibula types, and especially terra cottas and glass bracelets) are almost entirely absent. The militaria found in Empel can be interpreted as personal equipment deposited by individual soldiers who had completed their military service.⁵⁷

⁵³ On the interpretation of communities as symbolic constructs, see Cohen 1993.

⁵⁴ Tacitus, *Germ.* 39. Cf. Derks 1998, 75.

⁵⁵ Cf. the Hercules cult at the Forum Boarium in Rome, which is said to have originated from a sacrifice that Hercules himself once made there after having killed the monster Cacus (*DKP* 1, 1964, s.v. Cacus [W. Eisenhut]). Cf. also Tacitus' account (*Germ.* 3) of Odysseus erecting an altar at Asciburgium.

⁵⁶ Klomp 1994 (pottery, Empel); Seijnen 1994; Robeerst 2008 (animal bones, Empel and Elst).

⁵⁷ Cf. Roymans 1996, 31–32; Nicolay 2004. For the social interpretation of the practice of coin deposition at Empel, see Roymans/Aarts 2005. Significant too is the find at Empel of 26 bronze seal-boxes, used for sealing private letters on wooden writing tablets. These letters were probably used in a votive ritual and will for the most part have been written by soldiers (Derks 1998, 229–230).

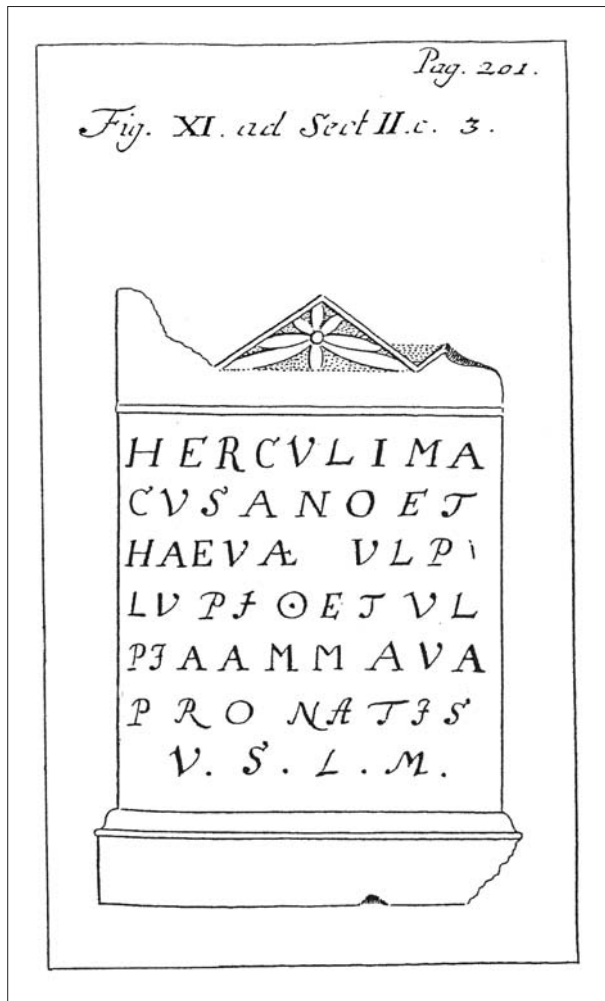

Fig. 10. Altar stone for Hercules Magusanus and Haeva from Over-Betuwe, dedicated by a Batavian couple for their children. The original is lost. Drawing in J.G. Keysler, *Antiquitates selectae septentrionales et Celticae*, Hannover 1720, 201, fig. XI.

There are good reasons to assume that Hercules played a special role as the patron of the Batavian *iuventus*. In Roman Italy as well as in the provinces, local communities had their formal *collegia* of *iuvenes*, who organised competitive sporting events – equestrian sports in particular – at special festivals.⁵⁸ In Celto-Germanic tribal societies, there were probably similar organisations of young men, which were predominantly military in nature and which consequently represented a politically significant force.⁵⁹ Tacitus tells us of the existence of a *iuventus* among the Batavians. He claims that mishaps that occurred when Vitellius ordered the recruitment of new troops from the *Bataavorum iuventus* were the immediate cause of the revolt of 69/70.⁶⁰ The prime importance of the Batavians as a supplier of auxiliary troops suggests that the *iuventus* here was a paramilitary-like organisation, which prepared young men for a soldier's life. We observe a general pattern

in the Roman empire, in which the *collegia iuvenum* manifested themselves as cult communities, with a specific deity as patron.⁶¹ Hercules emerges clearly as the most popular god, no doubt due to his military and sporting attributes. Given Hercules' position among the Batavians as principal deity in the public cult, it is probable that he functioned there too as protector of the *iuventus*. A possible epigraphic clue is the inscription on the altar stone from Over-Betuwe (fig. 10), dedicated to Hercules Magusanus and Haeva by a Batavian couple 'for their children'.⁶²

The Batavian cult places of Hercules may have been the concrete setting for the public initiation ritual of young male adults. Tacitus recounts the initiation of young men during a public *rite de passage* among Germanic groups:

(...) the custom is that no one takes arms until the tribe has endorsed his future competence; then in the assembly itself one of the chiefs, or his father, or his relatives equip the young man with shield and spear; this (...) is youth's first public distinction.⁶³

⁵⁸ Jaczynowska 1978, 34–35, 48 ff.

⁵⁹ Cf. Roymans 1990, 28–29, with further references.

⁶⁰ Tacitus, *Hist.* 4.14. For other examples of the military role of the *iuventus* in the northern provinces, cf. Tacitus *Ann.* 3.43; *Hist.* 1.68, 3.5 and 2.12.

⁶¹ Jaczynowska 1978, 55 ff.; Moitrioux 2002, 233 ff.

⁶² *CIL* XIII 8705.

⁶³ Tacitus, *Germ.* 13.

If we accept the idea that Hercules Magusanus acted as the patron of the Batavian *iuventus*, it seems obvious that such public initiation rituals would have been performed at the cult places of Hercules. In the Graeco-Roman world, too, the Hercules cult was strongly male-oriented and often associated with initiation rites of juveniles.⁶⁴

7 ON THE HERCULES CULT IN THE OTHER CIVITATES OF LOWER GERMANY

What can be said about the Hercules cult in other *civitates* of Lower Germany? I can only offer some hypotheses here, as the archaeological evidence does not allow firm conclusions. The occurrence of votive inscriptions in Bonn (2), Cologne (1), Xanten (2), and bronze arm rings with votive inscriptions from Bonn, Cologne and Grimmlinghausen, proves that Hercules Magusanus was also worshipped in the adjacent parts of Germania Inferior (cf. fig. 1).⁶⁵ Given the presence of several altar stones and a statue at Bonn and Xanten, we could even expect sanctuaries dedicated to this deity. However, it is not clear whether Hercules played a role in the public cult there; there is an absence of clues (e.g. associations with large monumental sanctuaries, or the involvement of *civitas* magistrates in the cult) to suggest this. Furthermore, it is significant that the votive inscriptions from the German Rhineland all date to the 2nd or 3rd century, while the earliest ones originate from the Batavian territory.⁶⁶ This may point to a relatively late diffusion of the cult from the Batavian region to neighbouring *civitates* in the east. However, the number of inscriptions is too small to be conclusive. The Hercules Magusanus cult may have had early roots there too, given the close cultural ties between the Ubii and the Batavians since the late 1st century BC.⁶⁷

Nevertheless, we must assume a considerable dynamic within the domain of the public cult of Lower Rhine groups, which is linked to their specific political and administrative integration into the Roman empire. One development that fundamentally affected the *civitates* of the Ubii and the Cugerni was the foundation of Roman colonies under Claudius and Trajan respectively. The massive settlement of veterans went hand in hand with the introduction of a new judicial framework, changing power relations, and a redefinition of collective identities. As a result of this large-scale settlement, the old, tradition-bearing core of the Ubii and Cugerni lost its political might or had to share it with the newcomers.⁶⁸ This undoubtedly led to a comprehensive reorganisation of the public cult and a reconsideration of the tribal descent myths of these communities.⁶⁹ The origin myth of the Ubii – possibly also via Hercules – was meaningless to the newly introduced community of veterans. The colony's new name, *Colonia Claudia Ara Agrippinensium*, referred to its founding by a member of the imperial house; no attempt at all was made to incorporate the Germanic-Ubian identity. In one of Tacitus' fictitious orations, it is precisely the abandonment of their ethnic identity with which the trans-Rhenish Tencteri reproached the Ubii

⁶⁴ Cf. *DNP* 5, 1998, 391, s.v. Herakles [Fritz Graf]. At several places (e.g. at Thassos), the Herakles cult was linked to a practice of ritual feasting and the transference of the first weapons to young men.

⁶⁵ For a list of votive inscriptions for Hercules Magusanus, see Derks 1998, appendix 3.1.

⁶⁶ Inscriptions from St.-Michielsgestel-Ruimel (first half 1st century AD) and Empel (96–early 2nd century AD).

⁶⁷ Cf. the recent study of the Late Iron Age *triquetrum* coinages in the Lower Rhine region (Roymans 2004, chapter

6), and the role of both groups in providing soldiers for the Germanic bodyguard of the Julio-Claudian emperors (Speidel 1994, 12 ff.).

⁶⁸ The latter may have occurred voluntarily. Tacitus (*Hist.* 4.65) suggests that there was large-scale intermarriage between veterans and the Ubian elite.

⁶⁹ Cf. the broader discussion in Scheid 1999, esp. 398 ff.; Derks, this volume. For comparable developments in the Roman province of Judaea, see Belayche, this volume.

in the context of the 69 AD revolt.⁷⁰ We should therefore assume a marginalisation of Hercules' position as principal deity in the public cult among the Ubii and the Cugerni following the foundation of the *colonia*. It is likely that this role was taken over by the Roman Mars.⁷¹ In any case, there was a Mars temple in Cologne in the Neronian period, where a sword ascribed to Julius Caesar was kept.⁷² It is tempting to link the building of this temple to the founding of the *colonia* under Claudius.

8 DISCUSSION

In this paper, I have discussed the role of Hercules in the creation of a Batavian identity in the context of the Roman Empire. My point of departure has been the assumption that the Batavians had to rewrite their history after their integration into the Roman world. The Hercules myth was a vital component in this process. Hercules probably played a prominent role in the origin myth of the Batavians and hence in their collective memory; they presumably saw themselves as his descendants. The appropriation of the Mediterranean Hercules myth reflected the friendly alliance they had with Rome at that time. Hercules Magusanus was thus a key element in the 'intentional history' created by the Batavians in order to forge for themselves a proper place in the Roman world.

We could also argue that the Hercules cult played a role in the ethnogenesis of the Batavians. This group was a relatively young creation from the period between c. 50 and 1 BC, the same period in which the foundations were laid for the cult of Hercules. The Batavians emerged following an amalgamation – probably orchestrated by Rome – of a small, but dominant *Traditionskern* of Chattian origin from the east of the Rhine, and an older indigenous population, who were probably remnants of the Eburones whom Caesar had destroyed.⁷³ Participation in the cult of Hercules, with its strong political and military associations, was undoubtedly a powerful integrating force among warriors who came from different subgroups of the emerging Batavian community. The social function of genesis stories was to symbolically express the identity and social cohesion of the new group. Furthermore, it is perhaps no coincidence that the Hercules sanctuaries of Empel, Elst and Kessel are of pre-Roman origin. Here, the connection with a ritual past may have strengthened the legitimacy of the newly formed Batavian community.

I would like to return here to the motives of Lower Rhine groups for appropriating the cult of Hercules. I have argued above that the Batavian choice of Hercules was partly determined by the fact that the Romans perceived them as Germanic and hence as barbarians. This points to the existence of some form of hierarchy in the descent traditions of provincial Roman groups. Foundation myths that forged a link with the Graeco-Roman world were a source of prestige within Roman Gaul. They needed to be negotiated and, certainly for Germanic groups, there were limits to what was feasible. The political relationship with Rome was the chief factor governing the success or failure of a claim to a prestigious descent tradition. Rome could reward certain *civitates* by formally recognising their foundation myths, as happened with the Aedui and the Remi. Other *civitates* might well claim such descent, but Rome could reject the claim, as appears to have been the case with the Arverni. At the time of Augustus, claims of blood ties with Rome by virtue of Trojan descent were a bridge too far for Germanic groups, including the Batavians. Other parties – Romans and Gauls – would have dismissed their claim as arrogant. They would have regarded descent from Hercules as more appropriate to the Germanic identity of the Batavians, but this claim was undoubtedly less prestigious than the foundation myth of the Aedui and the Remi.

⁷⁰ Tacitus, *Hist.* 4.64. Cf. also Tacitus, *Germ.* 28.

⁷¹ After the 1st century, it seems that the Hercules Magusanus cult at Bonn, Cologne and Xanten was largely carried on by soldiers, who viewed him as a Roman Hercules.

⁷² Suetonius, *Vitellius* 8, 10. See also Derks, this volume.

⁷³ Roymans 2004, chapter 5. We should probably view this *Traditionskern* as a band of warriors led by a pro-Roman aristocratic leader.

Finally, what are the prospects for further research in this field? Clearly, we will never come to know the myths associated with the Lower Rhine Hercules cult. What archaeologists can do, however, is uncover new evidence on the material culture relating to the cult of Hercules Magusanus. I see particular potential for future research into the public Hercules sanctuary at Elst. Such research may yield new information about the origin, development and social significance of the Hercules cult in Batavian society.

ABBREVIATIONS

<i>CIL</i>	<i>Corpus Inscriptionum Latinarum</i>
<i>DKP</i>	<i>Der Kleine Pauly</i>
<i>DNP</i>	<i>Der Neue Pauly</i>
<i>RIC</i>	<i>Roman Imperial Coinage</i>

REFERENCES

Classical sources

- Caesar, *De bello Gallico*, ed. H.J. Edwards, 1970, London/Cambridge Mass. (LCL 72).
 Diodorus, *Bibliothēke*, ed. C.H. Oldfather, 1960, London/Cambridge Mass. (LCL).
 Dionysius of Halicarnassus, *Antiquitates Romanae*, ed. E. Cary, 1968, London/Cambridge Mass. (LCL).
 Herodotus, *The Histories*, transl. Aubrey de Séincourt/A.R. Burn, 1981 (Penguin Classics).
 Lucanus, *Pharsalus*, ed. W. Ehlers, 1973, München.
 Parthenius, *Narrationes Amatoriae*, ed. J.L. Lightfoot, 1999, Oxford.
 Sidonius Apollinaris, *Epistulae et Carmina*, ed. W.B. Anderson, 1980, London/Cambridge Mass. (LCL).
 Suetonius, *Vitae Caesarum*, ed. J.C. Rolfe (2 vols), 1960, London/Cambridge Mass. (LCL).
 Tacitus, *Annales*, ed. J. Jackson (3 vols), 1979–1986, London/Cambridge Mass. (LCL 249, 312, 322).
 Tacitus, *Germania*, ed. M. Hutton, rev. E.H. Warmington, 1980, London/Cambridge Mass. (LCL 35).
 Tacitus, *Historiae*, ed. C.H. Moore, 1979–1980 (2 vols), London/Cambridge Mass. (LCL 111, 249).

Modern sources

- Allen, J., 2006: *Hostages and hostage-taking in the Roman Empire*, Cambridge.
 Bogaers, J.E.A.Th., 1955: *De Gallo-Romeinse tempels te Elst in de Over-Betuwe*, 's-Gravenhage (Nederlandse oudheden 1).
 Barlow, J., 1995: Gregory of Tours and the myth of the Trojan origins of the Franks, *Frühmittelalterliche Studien* 29, 86–95.
 Braund, D.C., 1980: The Aedui, Troy and the *Apocolocyntosis*, *Classical quarterly* 30, 420–425.
 Cohen, A.P., 1993² (1985): *The symbolic construction of community*, London/New York.
 Creighton, J., 2000: *Coins and power in Late Iron Age Britain*, Cambridge (New Studies in Archaeology).
 Derks, T., 1998: *Gods, temples and ritual practices. The transformation of religious ideas and values in Roman Gaul*, Amsterdam (Amsterdam Archaeological Studies 2).
 Derks, T., 1999: Between daily existence and divine order. The landscapes of Roman Gaul, in Ch. Fabech/J. Ringved (eds), *Settlement and landscape*, Moesgaard, 351–360.
 Derks, T./J. van Kerckhove/P. Hoff, 2008: *Nieuw archeologisch onderzoek rond de Grote Kerk van Elst, gemeente Overbetuwe (2002-2003)*, Amsterdam (Zuidnederlandse Archeologische Rapporten 31).
 Gehrke, H.-J., 2000: Mythos, Geschichte und kollektive Identität. Antike exempla und ihr Nachleben, in D. Dahmann/W. Potthoff (eds), *Mythen, Symbole und Rituale. Die Geschichtsmächtigkeit der Zeichen in*

- Südsteuropa im 19. und 20. Jahrhundert*, Heidelberg/Bonn (Heidelberger Publikationen zur Slavistik, Literaturwissenschaftliche Reihe, Band 14), 1-24.
- Goudineau, Chr./Chr. Peyre, 1993: *Bibracte et les Eduens. A la découverte d'un peuple gaulois*, Paris.
- Haalebos, J.K., 2000: Mosterd na de maaltijd. Een vergeten jubileum: Traianus en het jaar 98 na Chr. in Nijmegen, *Jaarboek Numaga* 2000, 9-41.
- Hobsbawm, E./T. Ranger (eds), 1983: *The invention of tradition*, Cambridge.
- Horn, H.G., 1970: Eine Weihung für Hercules Magusanus aus Bonn, *Bonner Jahrbücher* 170, 233-251.
- Huttner, U., 1997: *Die politische Rolle der Heraklesgestalt im griechischen Herrschertum*, Stuttgart (Historia Einzelschriften 112).
- Jaczynowska, M., 1978: *Les associations de la jeunesse romaine sous le Haut-Empire*, Wrocław.
- Jourdain-Annequin, C., 1992: Héraclès en occident, in C. Bonnet/C. Jourdain-Annequin (eds), *Héraclès, d'une rive à l'autre de la Méditerranée. Bilan et perspectives. Actes de la table ronde de Rome, Academia Belgica-École Française de Rome, 15-16 septembre 1989*, Bruxelles/Rome, 263-291.
- Klomp, A., 1994: Feestgelagen en het gebruik van aardewerk, in N. Roymans/T. Derks (eds), *De tempel van Empel. Een Herculesheiligdom in het woongebied van de Bataven*, 's-Hertogenbosch, 152-161.
- Levi, M.A., 1997, *Erocle e Roma*, Roma (Centro Recherche e Documentazione sull' Antichità Classica, Monografie 17).
- Lund, A., 1998: *Die ersten Germanen. Ethnizität und Ethnogenese*, Heidelberg.
- Moitrioux, G., 2002: *Hercules in Gallia. Recherches sur la personnalité et le culte d'Hercule en Gaule*, Paris (Gallia Romana 5).
- Nicolay, J. 2007: *Armed Batavians. Use and significance of weaponry and horse gear from non-military contexts in the Rhine Delta (50 BC – AD 450)*, Amsterdam (Amsterdam Archaeological Studies 11).
- Panhuysen, T.A.S.M., 2002: *De Romeinse godenpijler van Nijmegen*, Nijmegen (Museumstukken 8).
- Plácido, D., 1993: Le vie di Ercole nell'estremo Occidente, in A. Mastrocinque (ed.), *Ercole in Occidente. Atti del colloquio internazionale Trento 7 marzo 1990*, Trento (Labirinti, Collana del Dipartimento di Scienze filologiche e storiche 2), 63-80.
- Roberst, A., 2008: Dierlijk botmateriaal, in T. Derks/J. van Kerckhove/P. Hoff, 2008: *Nieuw archeologisch onderzoek rond de Grote Kerk van Elst, gemeente Overbetuwe (2002-2003)*, Amsterdam (Zuidnederlandse Archeologische Rapporten 31), 98-116.
- Roymans, N., 1990: *Tribal societies in Northern Gaul. An anthropological perspective*, Amsterdam (CINGULA 12).
- Roymans, N., 1996: The sword or the plough. Regional dynamics in the romanisation of Belgic Gaul and the Rhineland area, in N. Roymans (ed.), *From the sword to the plough. Three studies on the earliest romanisation of Northern Gaul*, Amsterdam (Amsterdam Archaeological Studies 1), 9-126.
- Roymans, N., 2004: *Ethnic identity and imperial power. The Batavians in the early Roman empire*, Amsterdam (Amsterdam Archaeological Studies 10).
- Roymans, N./T. Derks (eds), 1994: *De tempel van Empel. Een Herculesheiligdom in het woongebied van de Bataven*, 's-Hertogenbosch.
- Roymans, N./ J. Aarts, 2005: Coins, soldiers and the Batavian Hercules cult. Coin deposition in the sanctuary of Empel in the Lower Rhine region, in C. Haselgrove/D. Wigg (eds), *Iron Age coinage and ritual practices*, Mainz (Studien zu Fundmünzen der Antike 20), 337-359.
- Scheid, J., 1999: Aspects religieux de la municipalisation. Quelques réflexions générales, in M. Dondin-Payre/M.-Th. Raepsaet-Charlier (eds), *Cités, municipes, colonies. Le processus de municipalisation en Gaule et en Germanie sous le Haut Empire romain*, Paris, 381-423.
- Seijnen, M., 1994: Dierbotten en rituele maaltijden, in N. Roymans/T. Derks (eds), *De tempel van Empel. Een Herculesheiligdom in het woongebied van de Bataven*, 's-Hertogenbosch, 162-173.
- Slofstra, J., 2002: Batavians and Romans on the Lower Rhine. The romanisation of a frontier area, *Archaeological Dialogues* 9, 16-38.
- Speidel, M.P., 1994: *Riding for Caesar. The Roman emperors' horse guard*, London.

- Webster, J., 1994: The Just War. Graeco-Roman texts as colonial discourse, in S. Cottam e.a. (eds), *TRAC* 94, 1-10.
- Willems, W.J.H., 1986: The Roman fort at Arnhem-Meinerswijk, *Berichten van de Rijksdienst voor het Oudheidkundig Bodemonderzoek* 34, 169-196.
- Wolters, R., 1990: *Römische Eroberung und Herrschaftsorganisation in Gallien und Germanien. Zur Entstehung und Bedeutung der sogenannten Klientel-Randstaaten*, Bochum (Bochumer historische Studien, Alte Geschichte, 8).
- Wolters, R., 2000: *Die Römer in Germanien*, München (C.H. Beck Wissen 2136).
- Zieghaus, B., 2000: Der frühkaiserzeitliche Münzumschlag zwischen Alpen, Donau und Iller, in L. Wamser (ed.), *Die Römer zwischen Alpen und Nordmeer. Zivilisatorisches Erbe einer europäischen Militärmacht*, Mainz, 15-23.

Ethnic identity in the Roman frontier. The epigraphy of Batavi and other Lower Rhine tribes

Ton Derks

- 1 Introduction
- 2 Ethnicity and the Roman frontier
- 3 Ethnic identity and recruitment for the Roman auxilia
- 4 Batavi in the epigraphic record
- 5 Contexts of ethnic consciousness
- 6 Formulaic expressions of origin
- 7 Power, tradition and origin myths
- 8 Conclusions

Abbreviations

References

The Roman antiquities from the Netherlands show that the masters of the world did not live there with the same splendour and luxury as they did in neighbouring Gaul, Britain and the Rhine area. No colonies were founded on the poor heathlands and moors; no high rank official brought the magnificence and richness from the south. Remains of splendid villae, mosaic floors, marble cornices, columns and images have not been found here. The Batavian territory, too poor to produce tributes and taxes, was left to its own devices. But the sons of this unruly soil, hardened by the continuous struggle with an ungrateful nature and unfavourable climate, were fit for military service. Thus the Batavian territory was considered a breeding ground for soldiers of the Roman army (...).

Van Schevichaven 1881, i-ii
(author's translation)

I INTRODUCTION

The impact of empires on their colonial subjects is manifold and often reaches far beyond the visible material conditions of life that are the focus of much archaeological research.¹ Colonisers usually take control not just of the conquered land and its natural resources, but also of the people who inhabit it.

¹ This paper springs from a research project entitled *The Batavians: ethnic identity in a frontier situation (360-60-000)* funded by the Dutch Organisation for Scientific Research (NWO) and VU University Amsterdam. The article is the expanded text of a lecture read at the Valkhof Museum at Nijmegen in December 2004 and a

reworked version of a contribution originally published in Dutch as Derks 2004. I am grateful to the audience at Nijmegen and to Nico Roymans for their valuable comments, to Bert Brouwenstijn for drawing the maps of fig. 2 and 9, to Annette Visser for correcting my English.

Thus distinctions are made between those who control the land and those who occupy and work it. As Loren observes in a recent study on the impact of French and Spanish colonial rule in the 17th- and 18th-century American Southeast, the very demarcation and classification of the colonised constitutes an inherent part of colonisation.²

While the empire's classification of its subjects always reflects and serves its own needs and interests, redrawing the boundaries necessarily implies dividing pre-existing communities and amalgamating others; ultimately, it may even create new social categories that did not exist before while denying the existence of others. By simultaneously sanctioning certain social practices and discouraging or prohibiting others, such categorisation from above invariably has a profound effect on the self-understanding of the colonised. The post-Columbian Spanish empire in the Americas presents some nice examples of this. Whereas Spanish colonial rule focused on accommodating the *caciques*, the paramount leaders of the American Indians, by recognising their political authority, the Spanish crown also developed an elaborate, strict system of categorisation (the *régimen de castas*), which classified people by caste using a complex mix of ethnicity, phenotypic or racial characteristics, and legal status.³ Clearly, the caste system was designed to check and control the vast new colonial population of mixed-bloods, and to preserve the racial purity (*Espanidad* or 'Spanishness'), power and wealth of the coloniser. But the ultimate upshot of anchoring the imperial classification systems in everyday social practice was that the colonised largely adopted the identities imposed by colonial rule. As the net result was certainly not always advantageous to all, some colonised groups also employed a strategy of fashioning their own social identity by acting, dressing and behaving like individuals from another group, or defined themselves as different by giving themselves a new name. This strategy could be particularly helpful for those seeking to enter colonial situations from which they would normally be excluded.⁴

This paper deals with the Roman empire and the interplay between Roman imperial rule (and its projected identities) and the adopted identities of Rome's subjects. It focuses on the images and self-images of a particular tribe in the northwestern frontier of the empire, the Batavi. Since the tribal peoples on the periphery of the empire were largely illiterate (and the Batavians were no exception), modern accounts have often relied heavily on the writings of ancient authors.⁵ The written texts of classical ethnography scarcely epitomise objective, accurate description, however.⁶ It is therefore imperative that we juxtapose the stock images from Roman imperial writing – which since the Renaissance have often become our own (witness the quote at the head of this chapter) – with other source material. Inscriptions are a much neglected category of sources that offers an extraordinarily rich potential for research in this area. Inscribed monuments erected by individual members of local communities provide unparalleled access to subjective feelings of belonging even at the level of the individual.

At the heart of this paper is a systematic inventory of inscriptions that mention Batavians. A key question governing the examination of these inscriptions is to what extent the ways in which Rome's subjects are presented were their own choice (adopted identities) and to what extent they were influenced by structures of the empire in which they operated (projected identities)? In other words, what impact did the growing political integration of the Batavian community into the Roman empire have on the self-understanding of individual Batavians? When and where did they manifest themselves as an ethnic

² Loren 2005, 303.

³ Deagan 2001, 186 ff.; Loren 2005, 303 ff. According to Deagan (*ibid.*, 191), this ultimately resulted in the formal institutionalisation of racial mixtures into more than 25(!) categories, of which the mestizo, mulatto and quadroon are the best known.

⁴ Deagan 2001, 191; Loren 2005, 310, both citing Boyer 1997.

⁵ For some nice examples of the predominance of clichés in writing on the Batavians, see Roymans 1999; Ribbens 2004. Archaeological research on the Batavi did not start until the mid-20th century.

⁶ Cf. Woolf, this volume.

group and how much did that assist or impede their full integration into Roman society at large? What changes, if any, can we observe in forms of self-representation? Did the Batavi see themselves as the brave tribal warriors generally portrayed in classical ethnography? Or did they instead emphasise their status as fully-fledged members of the world community which we know as the Roman empire? And how then should we assess the Batavian case in comparison to that of their neighbours?

After broadly outlining the epigraphic evidence central to the argument in this paper (section 4), I will first discuss the social contexts of ethnicity (section 5) as well as the specific epigraphic formulae used to express affiliation (section 6). In order to avoid the pitfalls of working directly from the Batavian evidence alone, I will try to explain the emergent pattern against a background of wider developments within the frontier of the Roman Northwest, such as military recruitment and urbanisation, by constantly comparing and contrasting our case with that available for some other Lower Rhine groups. In the final section (7), I will investigate what conclusions may be drawn for the community's origin myths, which are generally thought to be crucial for the perpetuation of ethnic identity groups. But I begin this paper with a few remarks on the concept of ethnicity – concerning the correlation with material culture and the dynamics of ethnic categories – and a brief discussion of the frontier in the Roman Northwest (section 2), followed by a discussion of the possible impact of Roman army recruitment practices on the ethnicity of individual soldiers (section 3).

2 ETHNICITY AND THE ROMAN FRONTIER

Ethnicity refers to the collective identity of an *ethnos*, i.e. a tribe or people whose members subscribe to a perceived common origin. While material culture may have been instrumental in the construction of ethnic identities,⁷ the relationship between ethnicity and material culture is a complex one.⁸ Because of its strong symbolic value, material culture is by definition multivocal and capable of symbolising multiple aspects of human relationships, not just ethnicity. In contrast to earlier archaeological thinking, it is highly unlikely then that we would be able to identify items of material culture that could stand exclusively for only one particular ethnicity. Conversely, ethnicity is never expressed through a single material item. Nor are ethnic signifiers necessarily the same for all members of society: they may have gender, age and class aspects. Given this complex and arbitrary correlation between material culture and ethnicity, archaeologists will quickly become lost if trying to investigate ethnic issues without having access to additional written evidence that offers clues about where to look. It is hoped that inscriptions can help us to direct our research in the right direction.

Ethnicity is first of all about people's *perceptions* of their roots, or to quote a more scholarly definition by a Dutch anthropologist, 'ethnicity is a discursive, *subjective* construction of group difference'.⁹ This is not to say that ethnicity is simply bipolar. If ethnic categorisations are ethnocentric by default, group difference is located on both sides of the boundary between 'us' and 'them'. In other words, depending on the scale of observation, we may identify a hierarchy and a conglomerate of groups with graduated differences in familiarity and foreignness. Regardless of how well or poorly a group had integrated materially into the wider context of the empire, what mattered was how it defined its position symbolically. Origin myths and collective rituals are important concrete expressions of such symbolic thinking.

Although ethnic groups generally present themselves as bounded entities that never change, in reality they are shown to be dynamic and subject to change. History has revealed numerous examples of how

⁷ Cf. Loren 2005.

⁹ Abbink 2001, 14.

⁸ Generally, Hodder 1982; Jones 1997; for an early case study from Roman archaeology, Grahame 1998.

ethnogenesis processes and the dissolution of ethnic groups have transformed the ethnographic map of Europe over time. Two observations can be made about these processes of change: 1) the main driving force behind most modifications to the ethnographic map are changing configurations of power, and 2) if ethnic identity groups show significant changes, it would appear obvious that the binding factors of origin myths and collective rituals also change.

Frontiers are one geographical and socio-political context where ethnicity may be particularly relevant.¹⁰ Located on the periphery of nation states or empires, frontiers are best described as broad zones of interaction between an intrusive power and the indigenous tribes within its sphere of influence. Frontiers are not stable, but move with the expansion of empires. On the northwestern periphery of the Roman empire, we can identify four stages in the development of the frontier.

From Caesar's Gallic war until the Augustan administrative reorganisation concluded by the foundation of the federal altar of the Tres Galliae at Lyon in 12 BC, the northern frontier of the Roman empire comprised the entire area between the province of Gallia Narbonensis and the river Rhine. After the incorporation of Comatian Gaul into the empire's provincially organised core, the frontier shifted further to the north. From the beginning of the Germanic campaigns in 12 BC until the foundation of the two Germanic provinces under Domitian, it covered large areas on both sides of the Rhine, stretching from the military districts of Belgic Gaul across the Rhine far into Germany, where for the time being the river Elbe embodied the new symbolic boundary of the inhabited world. It was this shift in the main area of military operations that first put the spotlight on the Lower Rhine area, thereby producing the earliest historical records of the Batavians.¹¹ After the transformation of the military districts of Belgic Gaul into the provinces of Upper and Lower Germany around AD 84, the frontier comprised the area of the client tribes of 'Great Germany' north and east of the Rhine.¹² With the establishment of the Gallic empire in the third quarter of the 3rd century, the Lower Rhine and adjacent areas reverted to their frontier status, which they retained until the fall of the western empire in the early 5th century.¹³

As we saw in the introduction to this paper, the intervention of imperial powers in the frontier regions of their empires often reinforces some existing ethnic groups while at the same time creating new ethnic categories and disrupting others. Roman measures which may have been relevant in this respect were the annihilation, division or relocation of certain tribes, the targeting of tribal groups for ethnic soldiering, the settlement of veteran colonies, the creation of new political administrative centres, and the granting of municipal rights and citizenship. Of course, not all frontier peoples were affected by such measures in the same way or to the same degree. The Batavi, for instance, after splitting off from the Chatti on the Middle Rhine, were relocated in the heart of the Lower Rhine frontier. By virtue of a treaty with Rome they were exempt from capital and property taxes,¹⁴ but were exploited all the more for large-scale conscription: with eight *cohortes* of 500 men (replaced by four *cohortes milliariae* in the early 2nd century), one *ala* and many soldiers for the imperial horse guard and the German fleet, the Batavi were among the principal suppliers of manpower to the Roman army.¹⁵ As the vast majority of the epigraphically known Batavians appear to have been auxiliary soldiers, it may be useful to examine in more detail the potential impact of Roman recruitment practices for the *auxilia* on the construction of ethnic identity.

¹⁰ Barth 1969; Eriksen 1993; Chappell 1993; Rodseth/Parker 2005.

¹¹ Tacitus, *Ann.* 2.8 and 2.11.

¹² For the term, Alföldy 1997.

¹³ Cf. Willems 1984, 272 ff (chapter 12).

¹⁴ Tacitus, *Germ.* 29.

¹⁵ For the concept of ethnic soldiering, Van Driel-Murray 2005; for the Batavian *auxilia*, Strobel 1987; Roymans 1996, 20 ff, 84 ff; idem 2004, 3 f., 222 ff; Van Rossum 2004; for Batavians in the Germanic fleet, Tacitus, *Hist.*, 4.16.

3 ETHNIC IDENTITY AND RECRUITMENT FOR THE ROMAN AUXILIA

Long-term service in the Roman army inevitably left its mark on individual soldiers, especially on those who served in the auxilia. Many Roman army auxiliaries adopted a new name upon enrolment, and whether this was a Latinised version of their original native name or a completely new Latin or Greek name, to most men it meant adopting a partly new personal identity and a serious break with the past.¹⁶ The challenge of learning to understand, speak and perhaps even write the new language of power, as well as deployment in the remotest parts of the world among peoples who they had not even heard of until a short time previously, will certainly also have had an impact on the soldiers' self-image. While this may be relatively easy to understand, less comprehensible perhaps is the idea that service in the Roman army may have affected the soldier's ethnicity. This has everything to do with Roman recruitment practices and the army bureaucracy.

In contrast to the legions, most Roman army auxilia were levied from a single tribe. This was generally one of Rome's peace conditions stipulated in a treaty that left responsibility for the levy itself to tribal leaders.¹⁷ These units were referred to by the ethnic names, possibly preceded by a serial number, of the peoples from which they were conscripted. For our purposes, it is important to realise that, provided the tribal leaders recruited enough men, it will have been of little interest to the Roman authorities whether the men serving in these units did in fact belong to the ethnic group that gave the unit its name. For any recruits from other ethnic groups, however, this arrangement meant that for the remainder of their military career they were entered in the Roman army records as ethnic members of the tribe from which the unit, according to its name, had been recruited. This phenomenon will no doubt have occurred among the Batavian auxiliaries as well. In fact, recent demographic calculations show that Batavian society was too small to satisfy on its own the annual demand for the new recruits needed to maintain the eight Batavian cohorts and the *Ala Batavorum*. We must therefore conclude that there were scores of recruits from other groups, perhaps from Batavian client tribes, among the auxiliary soldiers listed as 'Batavian' in the army records.¹⁸ For these men, the benefits of gaining access to a military career more than made up for the incidental masking or sublimation of their own individual ethnic identity in favour of another collective ethnic identity linked to their unit.

If the ethnic units were nominally homogeneous at the time of recruitment, most would have lost their real or supposed homogeneity soon afterwards. In general, new recruits needed to fill the gaps left by dead or retired soldiers were no longer conscripted from the eponymous tribe from which they were initially recruited, but from the province where the unit happened to be garrisoned. There has been extensive discussion as to whether the Batavi, for reasons of their particular qualities as soldiers, were excluded from this trend toward local recruitment. I agree with Van Rossum that, despite the Batavian background of some of their commanders, ethnic recruitment for the Batavian auxilia ended in all probability some time in the early 2nd century.¹⁹ As long as troops were regularly moved, this resulted in quite mixed units, but once they started staying longer in the same garrison, from the Hadrianic period

¹⁶ Striking here are the Greek names adopted by soldiers figuring in the Vindolanda tablets (Birley 2001) and by Batavian members of the pre-Flavian horse guard in Rome. In the latter case, the choice may reflect conformity to onomastic conventions among slaves in the imperial service.

¹⁷ Wolters 1990, 109 ff., esp. 111 and 126 ff. Cf. also Alföldy 1968, 111 ff., esp. 116.

¹⁸ Van Rossum 2004, esp. 125, who draws this conclusion for the 2nd-century situation; to my mind, the same argument could be put forward for the 1st century. Cf. also Roymans 2004, 207 f., who reaches the same conclusion with regard to pre-Flavian recruitment but by a different route.

¹⁹ Van Rossum 2004, with the older literature. For ethnic recruitment in the late 1st, early 2nd century, cf. appendix B 19, B 25–26 and B 28.

onwards, the upshot was that units named after tribe x predominantly comprised soldiers from tribe y. Although the army continued to record the ethnic background of each individual soldier, this practice may have led to some ambiguity as to how these auxiliaries should categorise themselves collectively, as soldiers from tribe x or y. We will see an example of this in section 5.²⁰

The phenomenon of different categorisation scales leading to hierarchically overlapping identity groups is also apparent from evidence for Roman army recruitment. In addition to the ethnic units discussed above, the Roman auxilia also contained units recruited from several tribes and named after the group that served as the umbrella group, usually a province (e.g. Thracians, Raeti), but sometimes several provinces or a larger geographical area (e.g. Galli, Germani). For instance, the cohortes Gallorum – unlike the ethnic units levied from individual tribes in Belgic Gaul – consisted of volunteers conscripted from a range of tribes in the Tres Galliae. Similarly, the cohortes Germanorum were recruited from a series of tribes on both sides of the Rhine, in what the Romans called Great Germany, again inasmuch as they were not targeted for ethnic soldiering. Finally, we can say that to both Flavius Josephus and Suetonius the 1st-century imperial horse guard consisted of Germani.²¹ Interestingly, inscriptions from Britain and Rome suggest that these macro-categories existed not only within Roman army bureaucracy, but were also meaningful among the tribal people themselves. In contexts where soldiers from different tribes of the Lower Rhine frontier communicated with each other – Coventina’s well at Carrawburgh is a case in point – some presented themselves as *Germanus*, and in Rome the association uniting members of the Claudio-Neronian horse guard was called *collegium Germanorum* (fig. 1).²²

The predominance of Batavi in the imperial body guard of both the *Germani corporis custodes* and the *equites singulares Augusti* gave rise to a colloquial designation of the unit as a Batavian one. Suetonius tells us that Caligula received a divine warning in the sanctuary at the source of the river Clitumnus in Central Italy to supply the *numerus Batavorum* of his bodyguard with new recruits.²³ In his report of Hadrian’s military inspections, Dio speaks of the ‘so-called Batavian cavalry’ in the emperor’s retinue crossing the river Danube,²⁴ and a bilingual inscription on a tombstone from Anazarbus, Cilicia, in present-day Turkey, refers to the deceased – described in the Latin text as *equus singularis* – as ἵππεύς νομέπων Βατάων in Greek.²⁵ Even if in the early 3rd century the Batavian guard still dominated the horse guard to such an extent that their tribal name could become emblematic for the whole unit, other inscriptions prove that the unit still contained a substantial number of men from other parts of the empire, especially Pannonia.²⁶

Finally, mention should be made of the differential recording of the auxiliary’s home in Roman army rosters and official documents such as military diplomas. According to Speidel, the way in which a soldier’s home was recorded (province, tribe or town) varied according to where he came from and where he was sent to serve.²⁷ Whereas an auxiliary soldier’s native province was only given if he was sent abroad as a recruit, his tribe or town was stated if he had enrolled in a unit stationed or raised in his own province (local recruitment). There are two exceptions to this rule: 1) even when sent outside their home province, soldiers from Spain, Gaul and Germany were nearly always designated by their tribe or home town, probably because in these cases the terms Hispanus, Gallus or Germanus were ambiguous as to precisely which province they referred to,²⁸ and 2) auxiliarii who enrolled as Roman citizens retained

²⁰ Cf. notes 68–69 below.

²¹ Ios., *ant. Iud.* 19.1.15 (§ 119) on Caligula’s guard; Suet., *Cal.* 47; *Gal.* 12; Speidel 1984.

²² Clay 2008; Derks 2004, 57 ff. Cf. also note 28 below.

²³ Suet., *Cal.* 43.

²⁴ Dio 69, 9; cf. also *CIL* III 3676; Speidel 1991.

²⁵ *ESA* 688. Cf. also *ESA* 688 c–d, in which the unit is

designated as *numerus Bataonum* and *numerus e{x}quitum Batavonum*.

²⁶ Cf. *ESA* 657, 688a, 688c–d, 732.

²⁷ Speidel 1986. Once settled, it remained unchanged for the entire term of service.

²⁸ There are a few examples of *Germani corporis custodes* and *equites singulares Augusti* designated as Germani, e.g. Bel-



Fig. 1. Two inscribed funerary monuments from the cemetery of the *collegium Germanorum* at the Via Portuense in Rome, erected by members of the Germanic bodyguard (*Germani corporis custodes*) in commemoration of deceased fellow guardians of different Germanic backgrounds, Fannius (left) being of Ubian, and Indus (right) of Batavian descent. Rome, Museo delle Terme di Diocleziano (author's photographs).

Fannius / Neron(is) Claudi / Caesaris Aug(usti) / corpor(is) custos / dec(uria) Cotini / nation(e) Ubius / vixit ann(os) XIIIX. H(ic) s(itus) e(st). / Posuit Corinthus / dec(uria) aedem heres eius / ex colleg(io) German(or)um (AE 1952, 145 = Bellen A 12).

Indus / Neronis Claudi / Caesaris Aug(usti) / corpor(is) custos / dec(uria) Secundi / natione Batavus / vix(it) ann(os) XXXVI. H(ic) s(itus) e(st). / Posuit / Eumenes frater / et heres eius ex collegio / Germanorum (AE 1952, 148 = Bellen A 15).

their towns as their home even when sent abroad immediately upon enlistment. The best illustration of the impact of official recording on how individual soldiers presented themselves on private altars or epitaphs is the fact that, from Augustus to Trajan, we do not encounter a single exception to the above rule among the 173 stone inscriptions of the *auxilia*!²⁹

len B 7-8; ESA 378, 446, 558; cf. also ESA 356.

Holder 1980.

²⁹ Speidel 1986, 475, using the evidence collected by

Despite the relatively abundant epigraphic evidence for the Batavi compared to some other peoples in the northwestern frontier of the empire,³⁰ no up-to-date collection was available when this study began. The first catalogue of inscriptions was drawn up more than a century ago by the Dutch cultural historian, publicist and future municipal archivist of Nijmegen, Herman Van Schevichaven. In his booklet entitled *Epigraphie der Bataafsche Krijgslieden in de Romeinsche Legers* (Epigraphy of Batavian warriors in the Roman armies), written in Rome and Algiers and published in 1881, Van Schevichaven was able to gather some 50 inscriptions from findspots as far apart as Nijmegen, Lyon and Rome.³¹ The first collection after Van Schevichaven's and the only systematic one is presented in Byvanck's three-volume *Excerpta Romana*, a monumental survey of historical, epigraphic and archaeological sources for the Roman Netherlands. The second volume in the series, published in 1935 and entirely devoted to epigraphic evidence, contained all Latin inscriptions from the Netherlands then known, as well as those from abroad that could shed light on the people who settled in the territory confined by the actual national boundaries, especially the Batavi and the Cananefates.³² More recently, selections of inscriptions have been discussed in the context of research on the political institutions of the Batavi and Cananefates.³³ It goes without saying that new discoveries have not only rendered these surveys incomplete, they have sometimes also forced us to reconsider some of the old material. As a full discussion of each inscription is clearly beyond the scope of this study, the available evidence has been presented in the appendix at the end of this paper.

The guiding principle for my inventory of inscriptions is that the text must entail an explicit reference to Batavian descent. I will come back to the methodological implications of this criterion in the next section. Suffice it to say that this has resulted in a collection of 58 inscriptions referring to 69 Batavi; a Batavian descent is explicitly stated for 63 of them, with the remaining six being direct relatives, mostly brothers (appendix, table B).³⁴ Apart from this group of inscriptions, several categories have been defined for which Batavian descent may be surmised, with varying degrees of certainty. The first contains inscriptions erected by local magistrates and council members (table C). Although public offices in the local community will generally have been held by citizens from that *civitas*, examples of magistrates or councillors who served 'abroad' call for caution.³⁵ As there are no explicit indications of a 'foreign' origin, I assume that the *summus magistratus* and the two *decuriones* of the Batavian *civitas* were all of local stock. The second category contains people for whom we may assume a Batavian background on military-historical grounds. Service in a Batavian unit may be taken as a strong indicator, especially in the 1st and early 2nd century, but to avoid circular argument such cases have only been counted if there was addi-

³⁰ This was first recognised by Van Schevichaven (1881, ii-iii).

³¹ However, these included men for whom he unjustifiably assumed a Batavian background because of either the military unit they were serving in (e.g. *CIL* III 839) or a findspot in the Batavian home region (e.g. *CIL* XIII 8806, 8818).

³² One of the drawbacks of Byvanck's survey is that it offers virtually no datings and no – or only very brief – epigraphic commentary. The complete *Excerpta Romana*, including the volume with the inscriptions, can now be consulted electronically at <http://www.inghist.nl/retroboeken/excerpta/>.

³³ The most important one here is Bogaers 1960/1961.

³⁴ Children mentioned in Roman military diplomas issued to Batavian auxiliaries have not been included in this survey. In the military diploma from Elst two (anonymous) daughters were mentioned, in that of Regensburg three (cf. note 43 below).

³⁵ Most of them served in neighbouring communities or in a town where they had become residents. For the principle, see Thomas 1996, 28, 129-131; for concrete examples, *CIL* XIII 2669 = Krier 1981, no. 20 (Autun), *CIL* XIII 2873 (Alise Ste Reine), *CIL* XIII 5353 (Moirans-en-Montagne) and *CIL* XII 1685 (Luc-en-Diois).

tional confirming evidence such as onomastic clues or kinship relations (table D). In addition, a number of people bore the ethnic cognomen *Batavus* or the ethnic nomen derived from it, *Batavinus* (table E). Although they are often conjectured to be of Batavian origin, this is far from certain; all we can say for certain is that they will have had some relationship with the Batavi. Finally, for the sake of completeness, historically known Batavi have been listed (table A).

The oldest inscription dates from the reign of Tiberius, the youngest from the second half of the 3rd century. The chronological distribution develops from a hesitant start in the first half of the 1st century and a considerable increase in the second half, towards a culmination in the 2nd century, followed by a rapid decline in the early 3rd century. There is just one inscription for the late 3rd century, and epigraphic documents mentioning private individuals who explicitly designate themselves as ‘Batavian’ are completely absent for the 4th and 5th centuries.³⁶ This chronological division corresponds perfectly to a general pattern observed over large parts of the Roman empire and must certainly be associated with the adoption and abandonment of the epigraphic practice.³⁷ However, there are good reasons to assume that it is not just the drying up of our sources that prevents us from encountering any Batavians after the late 3rd century. Internal developments in Batavian society itself are just as important as the rapid decline in epigraphic evidence. Recent archaeological research has shown that many rural settlements began to be deserted from the early 3rd century on. Although 4th-century settlement traces are being uncovered (as was the case in Tiel, for instance), the excavated house types and associated material culture are completely different from the earlier phases, suggesting a major discontinuity.³⁸ At the same time, public sanctuaries such as those at Empel and Elst, which played a key role in the reproduction of Batavian identity, were devastated shortly before the mid-3rd century and not rebuilt thereafter.³⁹ And in the 270s the site of the tribal capital of *Ulpia Noviomagus* was even abandoned. Taken together, we cannot but conclude that at some time in the late 3rd century, the Batavian community (*civitas Batavorum*) ceased to exist as such. Although the memory of a Batavian identity group still lived on in some epigraphic and historically transmitted names of auxiliary units from the early 5th century,⁴⁰ it is unlikely that at this stage the soldiers serving in these formations were all still ethnic Batavians. By then, the old practice of ethnic soldiering had long been replaced by local recruitment in the garrison’s province.⁴¹

³⁶ However, the ‘Batavian’ label does turn up as part of regimental names in late Roman inscriptions as well as written sources. Cf. note 40 below.

³⁷ Mrozek 1973, 1988; MacMullen 1982; Woolf 1996.

³⁸ Heeren 2006; Roymans *et al.* 2007.

³⁹ Roymans/Derks 1994; Roymans 2004, 258; Derks *et al.* 2008, esp. 69 and 139 ff.

⁴⁰ Epigraphically, after the mid-3rd century, the ethnic label of the Batavi is only documented as a regimental name of both an infantry and cavalry unit in sarcophagus inscriptions from the late Roman cemetery at Concordia in Northern Italy. For these inscriptions, see *CIL* V 8743, 8752, 8759, 8761, 8773, 8776, and *AE* 1891, 101 (*Batavi seniores*), and *AE* 1891, 106 (*equites Batavi seniores*), with comments and corrected readings in Hoffmann 1963 and *id.* 1969, 75 ff. As Hoffmann (1963, 25; 1969, 83 ff, esp. 101, 526) convincingly demonstrated, these inscriptions must be dated to the winter of AD 393–394; for the history of their discovery and a description of the cemetery,

see *CIL* V, p. 1058, Hoffmann 1969, 61 ff and Lettich 1983, 17–37. These and additional units are mentioned in the *Notitia Dignitatum* (*Occ.* 5.19, 5.163 and 7.14: *pedites Batavi seniores*; *Occ.* 6.5, 6.47, and 7.167: *equites Batavi seniores*; *Occ.* 40.39: Cohors I Batavorum; *Occ.* 35.24: Cohors IX Batavorum), whereas in a more general sense – i.e. without the details of unit names – Batavian armed forces are mentioned throughout Ammianus Marcellinus’ *Res Gestae* (16.12.45, 20.1.3, 20.4.2, 27.1.6, 27.8.7, 31.13.8–9). It may be noted in passing that the Batavi are the only namegiving tribe of late Roman auxiliary units which is already known as such from the early empire. This may point to the continued (or renewed) exceptional importance of ethnic soldiering among the Batavi at the time the regiments of the late Roman army were first conscripted (i.e. under the tetrarchy or Constantine at the latest).

⁴¹ Hoffmann 1969, 81.

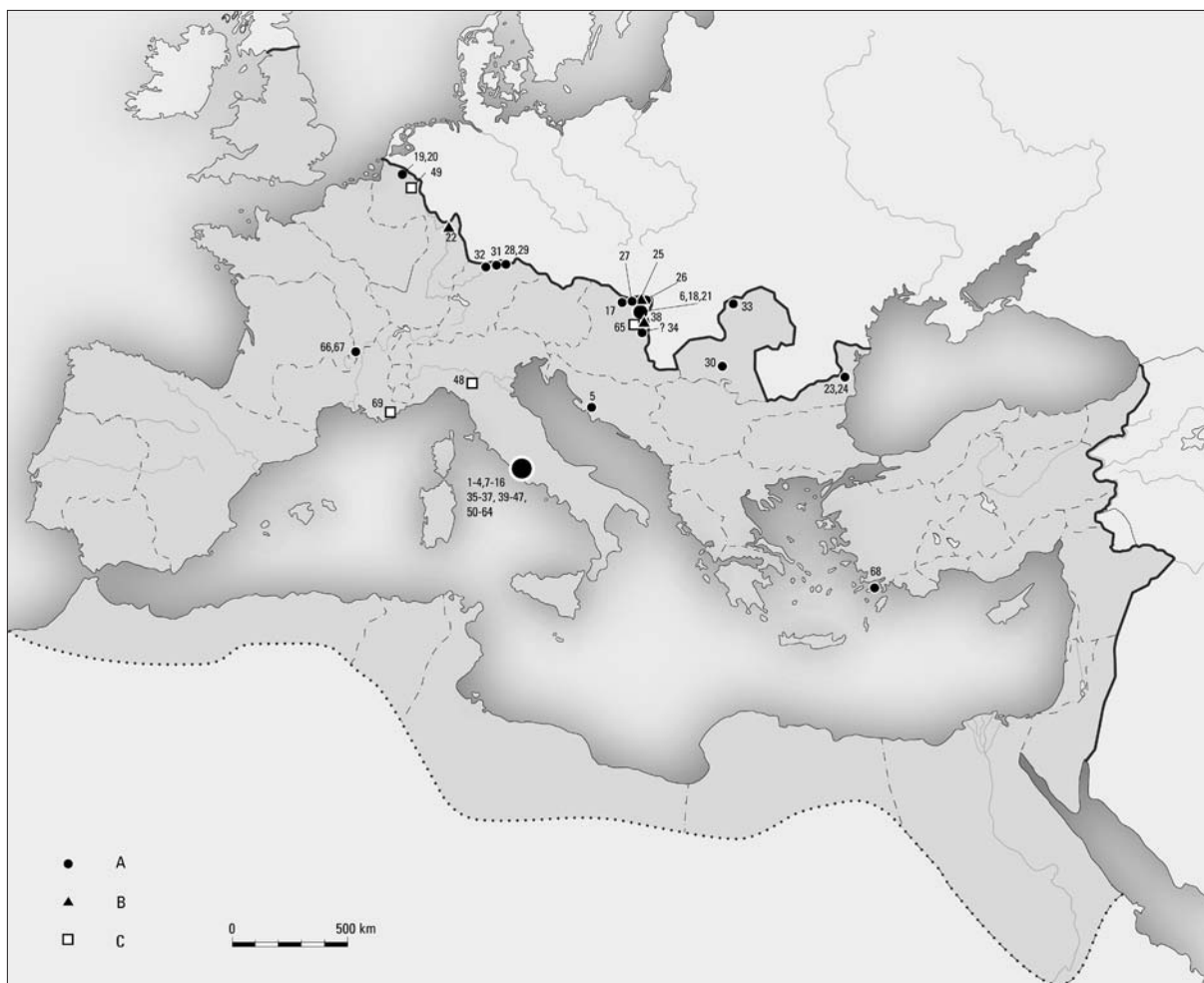

Fig. 2. Distribution of inscriptions including Roman military diplomas which explicitly mention individuals of Batavian descent.

A active auxiliary or legionary soldier, member of the imperial horse guard, or soldier of the praetorian guard; B veteran soldier; C civilian (small symbol: 1-2 individuals; medium size symbol: 3-4 individuals; large symbol: 5 or more individuals; numbering corresponds to that of table B in the appendix).

If we now take a look at the geographical distribution of inscriptions that mention Batavians (fig. 2), apart from a marked presence at Rome, we are immediately struck by the scattering of inscriptions in the frontier regions of the empire. The pattern's strong military bias is further confirmed by the military background recorded for most Batavians. Apart from Celerinius Fidelis (B 66), a former recruit in the 30th Legion based at Xanten who had succeeded in escaping the hardships of the ordinary soldier's life to become an *officialis* in the office of the financial procurator of Lugdunensis and Aquitania at Lyon (cf. fig. 7), the only Batavian outside the imperial capital not directly linked to the army is a gladiator (*retiarius*), who died and was buried in the North Italian town of Parma (B 48).⁴² Also instructive is the fact that the four Batavian women whom we know of were all the wives of serving soldiers and officers who followed their husbands through the empire during their period of service. Two of these women

⁴² The situation of the Tungri is highly comparable. Here we know of only two people who did not serve in the

army (cf. below table 5).

are known to us from military diplomas issued to their husbands on discharge: Mattua Silvani fil. (B 29) ended up with her Batavian husband M. Ulpius Fronto (B 28), a soldier in the Cohors I Batavorum, and their three daughters in the civil settlement near the auxiliary fortress of Regensburg-Kumpfmühl in Raetia,⁴³ while the Batavian wife (who remains anonymous) of a Frisian cavalryman, following her husband's discharge from the Ala I Hispanorum Auriana (B 32), then stationed in Biriciana/Weissenburg in Raetia, settled with her family in the vicinity of her husband's last posting in the Raetian countryside. The two other Batavian women are known to us from gravestones, which we know with varying degrees of certainty were erected by their husbands in the vicinity of their army camps: the Batavian Procula (B 30) was buried near the *castellum* of Tibiscum in the province of Dacia,⁴⁴ whereas [--- R]omana (B 65), who was married to the prefect (probably also a Batavian) of the Cohors III Batavorum milliaria, found her final resting place in the vicinity of the garrison town Vetus Salina in Pannonia Inferior.

In addition to these women for whom a Batavian origin is beyond question, our documentation also includes several examples of women for whom there is no final proof of a Batavian background, although all indications point in that direction. For example, we can assume on the basis of her nomen, formed by the Rhineland suffix '-inius', that Maturinia Pia (D 15), who we know from an inscription from Lyon (cf. fig. 7), probably came from Germania Inferior;⁴⁵ her relationship to a Batavian soldiering family makes it likely that she herself also originally came from the *insula Batavorum*. When her husband, the above-mentioned legionary Fidelis, was transferred to Lyon in the early 3rd century from his station in Xanten to serve as an *exactus* on the staff of the financial procurator of Gallia Lugdunensis (and Aquitania),⁴⁶ she had no choice but to go with him. Following his death and burial there at the age of 40, she stayed behind as a widow with three children in the Gallic provincial capital.⁴⁷ Finally, the probable Batavian Batavinia Romana (E 9), travelled with her husband M. Pub(licius) Adventus, a soldier in the same 30th legion from Xanten, to Aquitania, where they buried their 11-month-old son, named after his father M. Adventinius Fruendus, in Avaricum/Bourges.⁴⁸ It is not clear what brought them there, but Adventus was probably posted from his legion to the Lyon-based *vexillatio*, taken from the four Lower and Upper German legions which had taken over the job of the disbanded Cohors Urbana since Septimius Severus's decisive victory

⁴³ As the children of two Batavian parents, the daughters Vagatra, Sureia and Sata were Batavian by descent, although not explicitly designated as such in the diploma. The unit Fronto had served in was part of the army of Pannonia Superior at the time. It is unclear why Fronto and his family settled in Raetia; army service had probably brought him into contact with people in this army camp or the surrounding *vicus*.

⁴⁴ Her husband's name and background have not survived. If we assume, however, that her stay in Tibiscum was linked to her husband being based at the local fort, he may have served in the Cohors IVindelicorum. This unit was stationed in the Flavian period in Lower Germany (*CIL* XIII 8320 = *RSK* 272; *RMD* IV 216 from AD 98), and was transferred to Moesia Superior, undoubtedly in connection with Trajan's First Dacian war (*CIL* XVI 43 from AD 100). The unit arrived at Tibiscum shortly after the mid-2nd century (*CIL* XVI 107, dated to 156/157), or in the late 2nd or early 3rd century (Benea 1986, 452).

⁴⁵ On the Rhenish -inius *nomina*, in general see Weisgerber 1968, 135-138, 386-392, esp. map on 387; idem 1972; Bérard 2001, 669 ff, esp. 670 f.; cf. also Dondin-Payre 2001, 580 f.; Haensch 2001, 93 with notes 42-43. A Maturinia Galeta is known from Bonn (*CIL* XIII 8070), where she erected a funerary monument for her husband Liberalinius Vitalis, who had served in Legio I Minervia.

⁴⁶ For the duty of *exacti*, see Haensch 1997, 713 ff, esp. 722; Bérard 2000, 291 f.

⁴⁷ She may have been supported by her brother-in-law, Celerinius Augendus (B 67), an equestrian officer who completed the *tres militiae*, and who together with her took care of the gravestone. On Augendus' career, see *PME* C 104; Haensch 2001, 136.

⁴⁸ Both husband and wife bore a nomen that was typical of the Lower Rhine area. Cf. note 45 above.

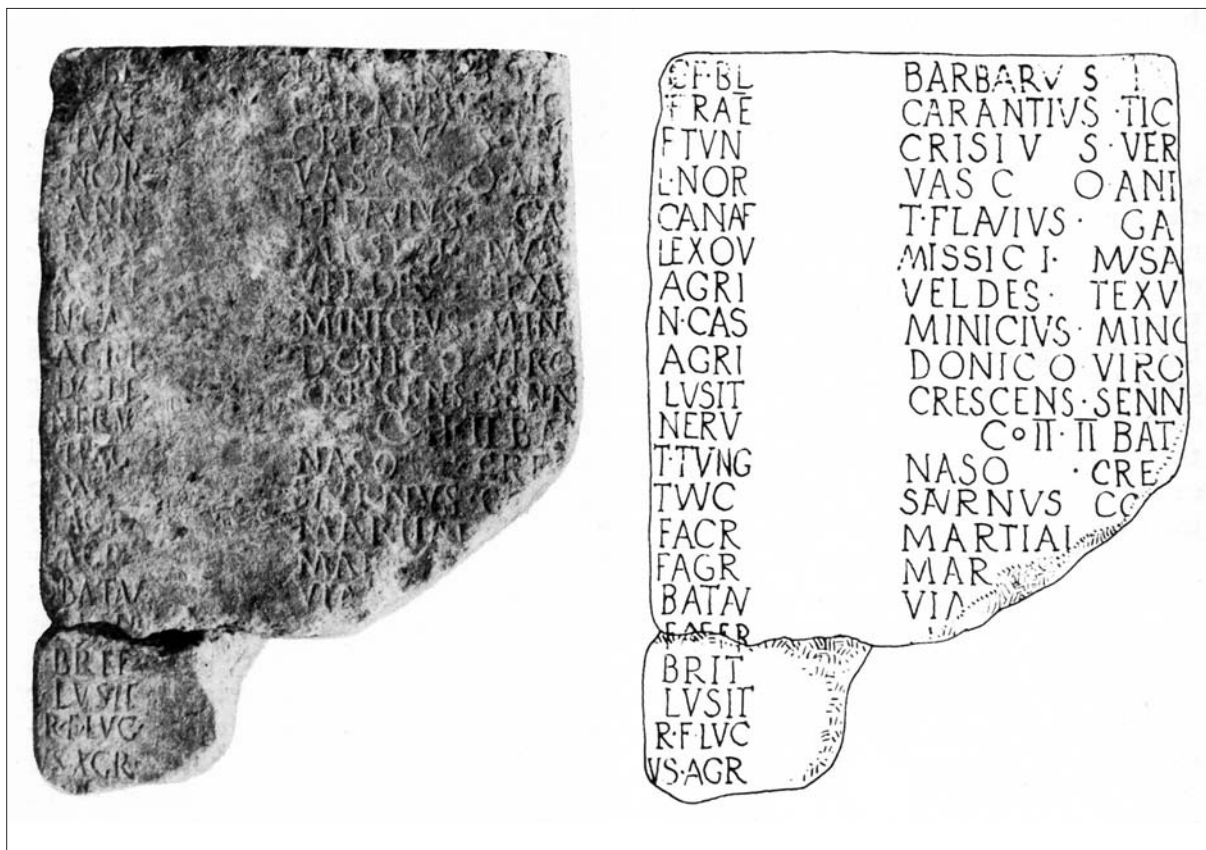

Fig. 3. Photograph and drawing of a stone slab (width 0.90 m) from the left side of the war memorial of Adamklissi (RO) erected 'to the memory of the very brave men who died for the country (*patria*)' in the emperor Trajan's Dacian wars showing two fragmentary preserved columns of soldiers' names and their origins. In the left column one Batavian is mentioned (l. 16), in the right the heading of the Cohors II Batavorum is followed by the names of five victims from this unit (after Doruțiu 1961, 358, fig. 3).

over Clodius Albinus in 197.⁴⁹ Once again, we know of these two women mainly through their husbands' military careers. However colourful their life stories may have been, they confirm the strong military bias of the epigraphic source material available for the Batavians.

If we look more closely at the men themselves, we see that in the provinces, with the exception of two legionary soldiers (B 22 and B 66) and a commander of the Pannonian fleet (B 34), they all served in the auxiliary forces of the Roman army.⁵⁰ Their presence in different parts of the empire is closely related to the military history of Batavian and other Lower German auxiliary forces. The few Batavians known to us for the 1st century served in a non-Batavian unit that was transferred from the Rhine to Dalmatia and Pannonia after their enrolment. In the early 2nd century, Batavians formed part of the Roman army that fought the Dacian wars, either in one of their own units or as soldiers enlisted in other 'national' units.⁵¹ At least two Batavian casualties were recorded on the impressive memorial altar that Trajan erected as a

⁴⁹ For the Lyon garrison, see Freis 1967, esp. 30 f.; Bérard 2000, 279; idem 2001. For the inscription, Haensch 2001a, 120, no. 122; Kakoschke 2004, 145, who in spite of the designation *miles* suspects that that this may have involved a veteran.

⁵⁰ B 68 was the 8-month-old son of a *centurio* from Legio II Parthica. Cf. note 80 below.

⁵¹ The Second Cohort of Batavians is recorded on the Tropaeum Traiani, but the First Cohort probably also took part in the war.

tribute to all those who had died in action on the battlefield near Adamklissi in present-day Romania (fig. 3). After the Dacian wars and the frequent transfers resulting from them, Batavians were mainly posted along the Upper Danube, in Noricum, Raetia and Pannonia.

Finally, we need to mention the single findspot with the largest number of inscriptions that record Batavians – the imperial capital at Rome. The vast majority of these inscriptions relate to Batavian soldiers from the imperial bodyguard, the *Germani corporis custodes* of the 1st century (cf. fig. 1) and the *equites singulares Augusti* of the 2nd and 3rd. These horsemen had been picked from the cavalry of the auxiliary forces in the provinces to serve the emperor in Rome and on his journeys across the empire. In the 3rd century, a few Batavian soldiers (B 52–56) worked their way up to the prestigious Praetorian Guard that also had its headquarters in the metropolis.

5 CONTEXTS OF ETHNIC CONSCIOUSNESS

Expressions of ethnic identity were only one way in which people sought to position themselves within the context of the Roman empire. As the empire's inhabitants naturally belonged to many, partly overlapping, social groups based on class, age, profession, gender, kinship, religion, language or origin (to mention only the most important axes of social organisation), they had many allegiances whose relative importance fluctuated according to context. This raises the question as to what precisely were the kinds of social context in which ethnic self-definitions became relevant and were expressed in inscriptions.

The guiding principle behind the inventory in this study is the requirement that a Batavian affiliation be explicitly mentioned in the inscription. While this has the great advantage of presenting a clear criterion that avoids the difficult issue of establishing origin on the basis of onomastics,⁵² it also has major implications for the results of our inquiry. After all, references to origin have proven to be context-dependent and particularly relevant in interaction with perceived ethnic 'others'.⁵³ If we inspect more closely the geographical distribution of inscriptions containing an explicit mention of Batavian descent, we see that not a single text appears to have been found within Batavian territory.⁵⁴ The local origin of people mentioned in votive or funeral inscriptions erected in their homeland was self-evident and usually went without saying; it was only abroad that Batavians revealed themselves as such. Conversely, it is only 'foreigners' who can be identified unambiguously in the epigraphy of the Batavian homeland.⁵⁵ Since an explicit statement of tribal affiliation makes little sense among fellow tribesmen, Batavians remain invisible in their homeland.

⁵² Cf., for instance, Solin 1994/95.

⁵³ In this respect, despite the distorting effects of the epigraphic habit, it is the *presence* in Roman Cologne of inscriptions mentioning Agrippinenses that requires an explanation, rather than the *absence* of Ubii (*contra* Carroll 2001, 128). Those who did refer to local citizenship in the frontier town will have had good reasons to do so, for instance, as a way of distancing themselves from others with whom they had otherwise much in common. We could think here of soldiers who wanted to stress their local origin as opposed to their numerous foreign colleagues, immigrants – including veterans and tradesmen – wanting to emphasise membership of the local citizenry despite a foreign origin (e.g. *CIL* XIII 8283 = *RSK* 219; *CIL* XIII 2023), and Ubians wishing

to underline their citizenship in the colony despite their (former) Ubian background (e.g. *CIL* XIII 8336 = *RSK* 304). For an overview of such exceptions in Gaul, Burnand 2005, 240, note 2.

⁵⁴ The military diploma of Elst is clearly an exception, but since such documents are products of the Roman army bureaucracy, they should not be included in a contextual analysis of ethnic *self*-ascription.

⁵⁵ For an example, cf. the recently discovered funerary stele from Houten which was erected for an auxiliary soldier from Forum Iuli. In contrast to the view expressed in my first publication of the inscription (Derks 2003; *AE* 2001, 1515), the Iulia mentioned in the text may have been the deceased's manumitted slave and wife. I thank Dick Whittaker for this suggestion.



Fig. 4. Vindolanda writing tablet (*TV* 164) containing an intelligence report of sorts on horse riding techniques of the native Britons, referred to in the first line as *Brittones*, and in the fifth by the patronising diminutive *Brittunculi*, ‘those wretched little Brits’. Photograph Oxford, Centre for the Study of Ancient Documents.

These two patterns are not of course unique to the Batavi, but apply generally to all tribal groups in the Roman world.⁵⁶

The idea that ethnicity is context-based cannot just be inferred from the inscription findspots, it is also evident in a few other patterns. For instance, it is conspicuous that nearly all Batavian soldiers whose tribal affiliation is mentioned were serving in a non-Batavian unit.⁵⁷ The only exception is a recently discovered epitaph from Solva/Esztergom in Hungary, erected by a Batavian soldier from the First Cohort of Batavians for his deceased father (B 26). Also important is an observation regarding the famous Vindolanda tablets. As we know, most of

these documents belong to the period when the Ninth Cohort of Batavians garrisoned the fort.⁵⁸ While the tablets contain many names of individual soldiers whose onomastics also show a clear connection with the Lower Rhine area,⁵⁹ so far there are only two instances where the soldier’s name is accompanied by his tribal affiliation. Tellingly, the men in question are a Treveran and – if the lacuna is correctly read – a Vangio, both foreigners in a cohort that at that time still largely consisted of ethnic Batavians. Birley has suggested that this recording of tribal affiliation may have been prompted by a desire to distinguish these men from Batavians of the same name.⁶⁰ Regardless of how we explain these two exceptions, the bulk of the Vindolanda evidence tells us clearly enough that ethnicity was hardly an issue in the daily routine of a Roman garrison.⁶¹

The situation may have been completely different as soon as the men left the walled circuit of the army camp on their patrols and encountered the enemy. A report on the fighting techniques of the

⁵⁶ Compare, for instance, the evidence collected in Wierschowski 2001 and Kakosche 2004.

⁵⁷ Again, this is not a pattern unique to the Batavians. Nouwen (1997, 261) made similar observations for soldiers from the Tungri.

⁵⁸ Bowman/Thomas 2003, 11–12, 23–26; periods II and III, ranging from c. AD 92 to c. AD 104/105.

⁵⁹ Birley 2001.

⁶⁰ *Ibid*, 246–247, note 15.

⁶¹ Although the unit was still ethnically homogeneous at

this time (cf. Van Rossum 2004), this does not mean that particular behavioural characteristics of these soldiers could not have functioned as ethnic markers to an outsider. One example is the sizeable consumption of beer, as recorded in the Vindolanda writing tablets (*TV* 190, 628; cf. also *TV* 182, 186, 482, 581). While beer consumption may not have been an exclusive prerogative of Batavian auxiliaries, it may have served as a pointer to a small circle of British or Germanic groups.



Fig. 5. Votive altar to Hercules Magusanus erected in the headquarters of the imperial horse guard at Rome by 'Batavian or Thracian citizens selected from the province of Lower Germany' to commemorate their share in the emperor's safe return to the capital. Dated to September 29, AD 219.

Herculi Magusano / ob reditum domini nostri / M(arci) Aureli Antonin[i] P[ri]m[us] / Felicis Aug(usti), equites singulares / Antoniniani eius, cives / Batavi sive Thraces adlecti / ex provincia Germania / inferiore, votum solverunt / libentes merito III Kal(endas) Oct(obres) / Imp(eratore) d(omine) n(ostro) / Antonino Aug(usto) II et / Tineio Sacerdote II co(n)s(ulibus) (CIL VI 31162 = ESA 62).

Britons is instructive here. We read that 'the cavalry does not use swords nor do the little Brits mount in order to throw javelins' (fig. 4).⁶² It seems that throwing javelins while mounted was the norm among the reporting scouts; the fact that they used the Latin diminutive *Brittunculi* to designate the unusual equipment and behaviour of their opponents betrays an attitude of superiority and contempt towards the native British cavalry. Such positioning with regard to close neighbours whose way of life hardly differs from one's own is typical of ethnic relationships, as is

the disproportionate attention to what, to an outsider, may seem insignificant details. I'll come back to this shortly. For the moment, we may conclude that such differences of detail only become clear and acquire meaning in interaction with those perceived as non-group members. Methodologically, it may be important to add that this feature of British ethnic identity focuses exclusively on the male section of society. What ethnic discourse among women would have looked like has gone unrecorded.

But let's return to the monumental inscriptions that form the bulk of our evidence. They direct our attention to two more settings in which ethnicity may have been relevant. The first is death in a foreign country. The vast majority of Batavians living outside their homeland have become known to us through their epitaphs. Death was of course an occasion par excellence in which those who stayed behind could look back on the life of a beloved relative or friend. Aspects of status, age, and class roles, alongside flattering descriptions of the deceased's character, were normally selected for inclusion in the commemorative inscription on funerary monuments erected to their memory. It seems that one thing that certainly mattered in the event of death in a foreign country was to refer to the deceased's ethnic background. It is impossible to say whether explicit mention of this detail was prompted by regret at the premature death that prevented burial in the deceased's native soil, or by a feeling of pride that also reflected on those responsible for erecting the monument (after all, they too will often have had a similar background). If the outward form of the commemorative monument bore any relation to the form of the funeral ceremony, we have to assume that most Batavians who died abroad were buried according to local custom rather than to that of their home region.⁶³

⁶² TV 164: (...) *Brittones / nimium multi equites / gladis non utuntur equi/tes nec residunt / Brittunculi ut iaculos / mittant.*

⁶³ Cf. Derks 2004, regarding the monuments of the *Germani corporis custodes*.

The second setting in which a person's origin could be mentioned was dedications. We can distinguish here between individual and collective dedications. Private dedicators acting on their own rarely mentioned ethnic background. The few exceptions from the Lower Rhine include a dedication by a legionary soldier from Arezzo in Cologne⁶⁴ and a series of votive altars erected by Gaulish *negotiatores* in the sanctuary of Nehalennia, now off the coast near Colijnsplaat.⁶⁵ No single example survives for the Batavians.⁶⁶

Dedications that make explicit reference to ethnic background were normally acts of collective worship. A nice, and at the same time unique, example are the *cives Batavi sive Thracae adlecti ex provincia Germania inferiori*, Batavian or Thracian horsemen who were selected for the imperial bodyguard in Rome after serving in the auxilia from Lower Germany (fig. 5). On returning from a journey to the Orient with the emperor Elagabalus, they dedicated an altar *ob reditum imperatoris* to Hercules Magusanus, one of the prominent gods in their last province of service. Soldiers from a particular ethnic group describing themselves as *cives* of a certain area and joining together for a dedication to a god or emperor were no exception in the Roman world. To mention just one familiar example, the German *cives Tuihanti* serving in a Frisian unit based at Housesteads erected several altars on Hadrian's Wall to Mars Thingsus and the two Alaisiagae, otherwise unknown goddesses whose cult most probably originated from their home area on the continent.⁶⁷ Noteworthy in the Batavian example is the use of the syndeton *sive* as a conjunction between *Batavi* and *Thracae*. It suggests that, to the authors of the inscription, there was hardly any difference between the Thracian and Batavian element mentioned in the text. This has led to the interesting assumption that the altar's dedicators were Batavians recruited to a Thracian unit while it was stationed in Germany. This would fit well with our knowledge of the development of the recruitment system for the Roman army auxilia. In the early 3rd century, a nominally Thracian unit that had stayed long enough in the Batavian area would certainly have included large numbers of *Batavi*.⁶⁸ If this interpretation is correct, the inscription nicely illustrates the bureaucratic impact of the Roman army's changing recruitment strategies on the collective self-representation of recruits.⁶⁹

An interesting aspect of the dedication by the 'Batavi or Thracians' is that, like the *Tuihanti* mentioned earlier, they apparently acted without their colleagues serving in the same unit. This raises the question as to what happened to those excluded soldiers. Were they so few in number that they were simply neglected?⁷⁰ Or should we imagine them doing the same with respect to their provincial gods? From a modern point of view, such separate and potentially divisive actions by different sections of the same military unit

⁶⁴ *CIL* XIII 8174 = *RSK* 15.

⁶⁵ Derks 1998, 144, table 4.1; Stuart/Bogaers 2001.

⁶⁶ Without explicit information on the dedicator's background, votive inscriptions to 'Batavian' gods such as Hercules Magusanus or Vagdavercustis cannot in themselves be taken as a reliable indication that the dedicator was a Batavian.

⁶⁷ *RIB* 1593-1594. Likewise, soldiers recruited from areas either larger or smaller than a tribe and serving within a particular military unit could join together for worship. Compare, for instance, dedications by *c(i)ves Raeti* (*RIB* 2100), a *pagus Vella(v)us* (*RIB* 2107, Birrens), and a *pagus Condrustis* (*RIB* 2108), all serving in the same Cohors II Tungrorum based at Birrens.

⁶⁸ Noy 2000, 222. Of the Thracian units that had been stationed some time in Lower Germany, only the mixed

Cohors IV Thracum, the Ala I Thracum, and the Ala Classiana Gallorum et Thracum may still have been in the province by the late 2nd or early 3rd century and eventually have functioned as the guards' mother units. On these units, Alföldy 1968, 17 ff, 36 f., 71 f.; Bogaers 1974; Eck/Pangerl 2004 (complete diploma from 5.9.152).

⁶⁹ The alternative would be to explain the asyndeton by the similar high-quality horsemanship for which both *Batavi* and *Thracians* were renowned. The differential recording of their homes (tribe or province) matches the patterns observed in Roman military records (cf. above, note 27) and would again be testimony to the influence of the Roman army's official records on the soldiers' forms of self-representation in their private monuments.

⁷⁰ For non-Batavian members of the guard, cf. note 26 above.

would seem a threat to the unit's internal cohesion and esprit de corps. But judging by the evidence available for other formations, such as the Second Cohort of Tungrians, acts of worship by sections of army units were not viewed as a problem by the army authorities, probably because, in line with Rome's general attitude in religious affairs, they were seen to add to rather than replace the official army religion.⁷¹ From the Roman point of view, the 'native' gods of these ethnic groups were thus additionally recruited for the well-being and safeguarding of the unit; for the ethnic military enclaves themselves such collective acts of worship to the main gods of their home area were an important instrument for maintaining bonds of solidarity among like-minded fellow tribesmen while remaining fully loyal to the Roman cause.

Although acts of worship such as those by the Batavian or Thracian guard may have been quite routine and need not indicate any political unrest, they may well have triggered a heightened ethnic solidarity and consciousness. In two inscriptions from Xanten and Rindern, citizens from the Lingones and Remi joined together to thank the principal gods from their home regions for the well-being of emperor Nero, as well as for the salvation of the citizens (*ob cives servatos*).⁷² In this case, the addition of the latter formula does hint at a serious threat to public order; this has variously been identified with invasions by groups of Frisians and Amsivarii in AD 57/58, with the great fire of Rome in AD 64, with the Pisonian conspiracy in AD 65, or with the revolt of Vindex in AD 68.⁷³ The exact historical context is irrelevant for our argument here; what matters here is that, after the crisis had been averted, these ethnic enclaves hastened to proclaim their loyalty to and sympathy with the sovereign authority in order to ensure that they were on the right side of the divide.

The Batavian revolt provides a clear example of how, in times of crisis or dramatic political upheaval, ethnic sentiments could be mobilised against the imperial power. To conclude this survey, I will touch upon one particular episode from this uprising that not only underpins my point, but is also particularly instructive as to the role of material culture in ethnic discourse.

During the Batavian revolt, the trans-Rhenish Tencteri sent envoys to the colony of the neighbouring Ubii.⁷⁴ Not unlike the Tencteri, the Ubii had always claimed a Germanic origin. Since the establishment of a Roman colony under Claudius, they had quickly adopted Roman customs. For a long time, this had remained unproblematic: significantly, Julius Civilis himself, the leader of the anti-Roman coalition, had his son educated in the colony.⁷⁵ But the changed political circumstances of the revolt suddenly transformed the symbols of *Romanitas* into a focus of hatred. In return for tearing down the walls of 'slavery' and killing all Romans in Ubian territory, the Tencteran envoys promised the Ubii a life as a 'pure, unaffected people, forgetting its former slave status'. The 'offer' was of course unacceptable to the Ubii. They replied that while all foreigners had already been killed or had fled to their home towns, the veteran settlers of the first hour had intermingled with them through marriage with native women to such an extent that they and their children considered the Ubian colony to be as much their *patria* as the Ubii themselves did.⁷⁶

⁷¹ For army religion, cf. Herz 2002; Stoll 2007. For the divisions of the Tungrian cohort, cf. note 67 above. There is some indication that these monuments were erected more or less simultaneously: one pair (*RIB* 2107 and 2108) shows essentially the same wording, whereas the third inscription (*RIB* 2100) was erected under the same prefect as one from the pair (*RIB* 2108). Finally, there is a dedication to Minerva by the whole unit, again under the same prefect (*RIB* 2104).

⁷² *CIL* XIII 8701 = *AE* 1980, 656; *AE* 1981, 690. Cf. *CIL* XIII 11806; Derks 1998, 89 f.

⁷³ Wierschowski 2001, 410.

⁷⁴ Tacitus, *Hist.* IV, 64.

⁷⁵ Tacitus, *Hist.* IV, 63.

⁷⁶ Since very few local women will have had Roman citizenship in the early 1st century, Tacitus' description implies that the deduced legionary veterans were given the right of *conubium*. Cf. Vittinghoff 1994, 288 f.; Haensch 1999, 649 f. For an instructive epigraphic example of intermarriage between a putative legionary soldier and a native Ubian woman, see *CIL* XIII 8565 (Neuss).

From an archaeological point of view, this example has some wider relevance since it shows again how particular details are temporarily selected from the entire cultural package and treated as typical of a certain ethnic identity. In times of immense political pressure, heightened ethnic awareness clearly leads conflicting parties to emphasise selective details and neglect others – in short, it produces stereotypes. This is what is amply illustrated here: circumstances had reduced the multiple bonds of interaction existing between members of *Civilis*' coalition and the inhabitants of the colony to a stereotypical opposition between 'Germans' and 'Romans'.

Summing up, we may conclude that ethnicity is a situational construct that becomes relevant only in particular contexts. Although ethnic background was entered in each soldier's personal files in the army archive, the Vindolanda evidence suggests that it went largely unrecorded in the paperwork that reflected each unit's daily routine. At the same time, the recruitment practices of the Roman army fostered bonds of ethnic solidarity within these same *auxilia*. The sources suggest that the most important contexts were collective acts of worship by soldiers from the same ethnic background but serving in mixed units, as well as funerals for soldiers and veterans who died abroad. In the latter case, ethnicity was often deemed a relevant aspect that merited mention in an epitaph. In the interaction with the social environment of the fort, ethnic difference was not located in objective phenotypic difference, but in subjectively selected details of cultural practices, such as horse riding, which up to a point were broadly similar among the interacting groups. In times of political tension, ethnicity sometimes became a matter of life and death, whereby particular forms of behaviour or material culture were randomly selected and magnified to create stereotypical oppositions.

6 FORMULAIC EXPRESSIONS OF ORIGIN

Having presented the evidence for Batavians in the epigraphic record and outlined the contexts of ethnic consciousness, we will discuss in this section the precise epigraphic formulae used in inscriptions to describe origin. We will investigate what distinct shades of meaning might have been involved, ask whether these remained unchanged and always relevant, and see what conclusions may be drawn from their chronological development.

We can distinguish three distinct principles of self-ascription in the terminology used to describe origin in the epigraphic evidence: 1) tribal affiliation, employing the term *natione* or *domo* in conjunction with the ethnicum,⁷⁷ 2) civic ascription built on the term *civis*, again followed by the ethnicum, and 3) geographical provenance through mention of the *caput civitatis*. In almost half of all inscriptions, the Batavi expressed their affiliation by the formula *natione Batavus* (table 1).⁷⁸ From a cultural philosophical perspective it is noteworthy that *natione* derives from the Latin verb *nascisci*, 'to be born'. Etymologically, the term thus refers to the idea of kinship through birth, one of the key notions that even today underlies much ethnic thinking. In the Roman empire origin was indeed hereditary rather than territorially defined.⁷⁹ This is nicely illustrated by the epitaph erected by a Batavian *centurio* for his 8-month-old son: although the boy was said to be *nat(ione) Batav(us)*, his very young age in combination with a burial place

⁷⁷ The adjectival form of the province's name could perhaps be used, e.g. *Raetus*, *Pannonius* etc. As this is unattested for tribes from the Lower Rhine (cf. above, note 27), I won't elaborate on this elsewhere in this paper.

⁷⁸ The inscription from Riez (B 68), which is the only

one that has to be dated to the second half of the 3rd, or possibly even the 4th century AD, has not been included, whereas those listed in the appendix under nos B 49-51 have been counted among the 2nd-century inscriptions.

⁷⁹ Thomas 1996.

Specification of origin	I A	I B	II	IIIA	total
<i>natio Batavus</i>	1 (0)	11 (1)	8 (7)	9 (9)	29 (17)
<i>domo Batavus</i>		3 (0)	1 (1)		4 (1)
<i>Batavus</i>		3 (0)	10 (5)		13 (5)
<i>Ulpia Noviomago (natio) Batavus</i>			4 (4)		4 (4)
<i>(Ulpia) Noviomago (Batavorum)</i>			7 (7)	4 (4)	11 (11)
<i>civis Batavus</i>				2 (2?)	2 (2?)
total	1 (0)	17 (1)	30 (24)	15 (15)	63 (40)

Table 1. Specification of origin in inscriptions by Batavian individuals between the first half of the 1st and the first half of the 3rd century AD. The number of people who possessed Roman citizenship is given in brackets (cf. appendix).

at Cnidus in Asia Minor makes it very unlikely that he was actually born on Batavian soil.⁸⁰ As the other, perhaps dominant, meaning of the Latin *natio* shows, the point of reference for this kin-ordered concept of origin appears to have been a people or tribe. If we take both shades of meaning together, the term *natio* seems to denote a tribal affiliation adopted through birth.

In three inscriptions from Pannonia the formula *domo Batavus* is used to express a Batavian origin (fig. 6). The form is a regional variant which was particularly popular in the Danube provinces.⁸¹ While it has the same connotation of defining origin through descent, the point of reference is the house rather than the tribe. Although there is ample evidence to show that the concept of ‘house’ refers to both the physical building that provides shelter and the social group that inhabited it,⁸² it is important to remember that not every residence could be called a *domus*: for a house to be designated as such, it had to be the seat of the family as apparent from the presence of the *lares familiares*. Judged against this background, expressions such as *domo Batavus* principally refer to an understanding of the Batavians as an ancestral lineage group with a shared origin.⁸³

In addition to this first group of formulae which conceptualise origin as a form of kinship, other forms of expression employed the term *civis*, followed by the adjective of the people or the town to which the person belonged, e.g. *civis Batavus* or *civis Agrippinensis* (fig. 7). Both forms emphasise political-administrative ascription to the civic community (*civitas*) where the individual was inscribed as a citizen. As many inscriptions by *peregrini* show, the citizenship referred to in such inscriptions is always a *local* one (e.g. *civis* of the *civitas Batavorum*), which did not necessarily imply *Roman* citizenship of the metropolis. If the local community happened to be a Roman colony, only inhabitants with full Roman citizenship were allowed to call themselves citizens. Both forms are rare among the Batavians: only two people presented themselves as *cives Batavi* (B 66 and B 69; cf. fig. 7), and we have no example of Batavians who described themselves as *cives Noviomagenses*.

⁸⁰ *Contra* the editor of *CIL* III 14403, who reads *D(is) M(anibus) / T. Fl(avius) Maritimus / eq(ues) R(omanus) nat(us) / Batav(us) vixit*, etc. For other Batavian children who in all probability were born in a foreign country, see note 43 above.

⁸¹ Krier 1981, 173.

⁸² Cf. Saller 1994, 80 ff. The sense of *domus* as a family

group is of course well-known for the Imperial House and epigraphically widely attested by the formula *in honorem domus divinae* used in all forms of dedications. See also the discussion on *domo* below.

⁸³ Given the findspots of these inscriptions, *domo* cannot have referred to the place of residence, the *domicilium*, as opposed to the place of birth, the *patria*.

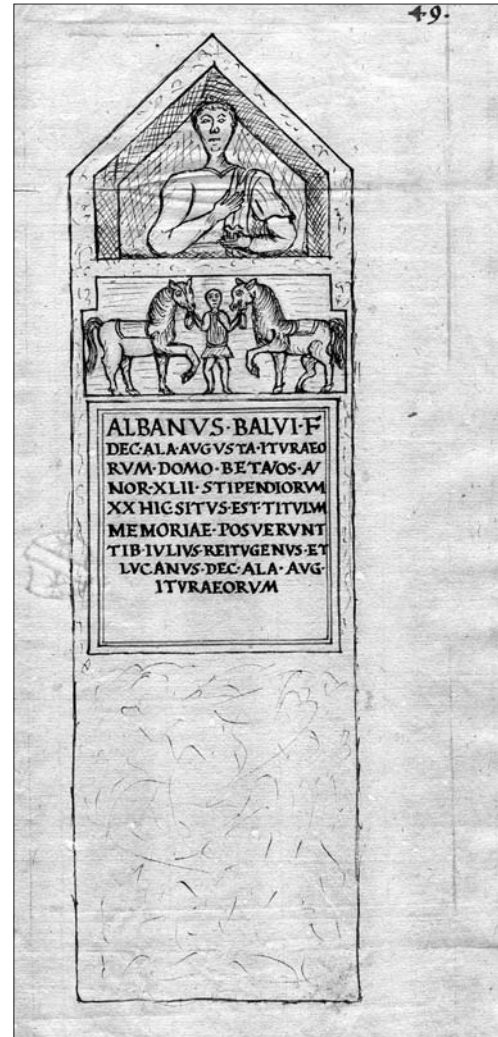

Fig. 6. Funerary monument from Brigetio/Szőny (H) erected by two decurions of the Ala Augusta Ituraeorum for their Batavian fellow decurion Albanus Balvi f. The stele's gable, with the deceased's portrait, now lost, is known from a drawing by Bartholomaeus Jupp in a manuscript from AD 1588 which is kept in the library of the University of Leiden. With the formula *domo Betavos*, the mentioning of Albanus' origin follows a regional convention. Photograph Kunsthistorisches Museum, Vienna; drawing after Voss. Lat. O. 65, folia 49r, University of Leiden.

Albanus Balvi f(ilius) / dec(urio) ala Augusta Ituraeo/rum domo Betavos an/nor(um) XLII stipendiorum / XX hic situs est. Titulum / memoriae posuerunt / Tib(erius) Iulius Reitugenus et / Lucanus dec(uriones) ala Aug(usta) / Ituraeorum (CIL III 4368).

A neutral but ambiguous way of indicating origin was to employ the simple ethnicum (e.g. *Batavus*), used either as an adjective or as a substantival noun. Through the omission of *natione*, *domo* or *civis*, it could be read as the abbreviated form of each of the formulae discussed above. While this was the standard way of recording a soldier's background in Roman army files, as is apparent from official documents such as military diplomas and *laterculi*,⁸⁴ it remained incidental as a form of Batavian self-ascription (B 5 and B 49).

Finally, throughout the Latin West we find references to the tribal capital of a *civitas* as a common form of describing origin in geographical terms.⁸⁵ Whenever Batavians employed this way of describing their roots,

⁸⁴ Cf. note 27 above.

⁸⁵ As the examples for the Roman colonies at Cologne and

Xanten show, a distinction can be made here between officeholders who tended to use the town's full title,

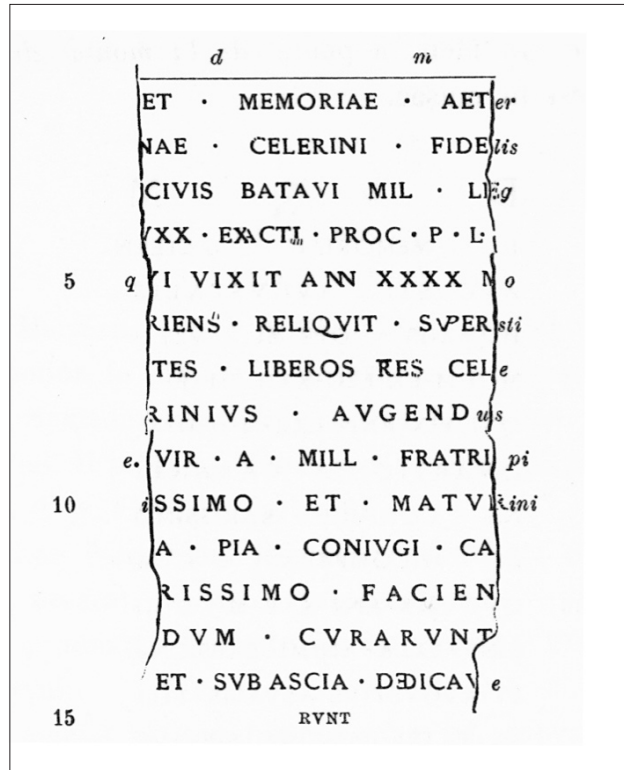
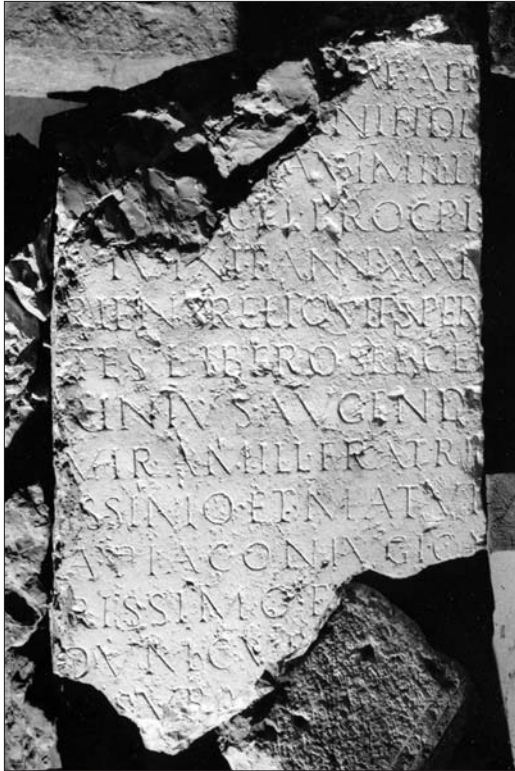

Fig. 7. Funerary inscription from Lyon for the Batavian legionary soldier Celerinius Fidelis erected jointly by his brother Celerinius Augendus and his wife Maturinia Pia. He is said to have been a Batavian citizen, *civis Batavus*. Photograph Musée gallo-romain de Lyon, Département du Rhône; drawing after *CIL* XIII 1847.

[D(is) M(anibus)] / et memoriae aet[er]nae Celerini Fide[li]s / civis Batavi, mil[iti]s le[g]ionis / XXX, exacti proc[ur]atoris p[ro]vinciae Lugdunensis, / [q]ui vixit ann[os] XXXX, m[or]iens reliquit super[st]ites liberos tres. Cel[e]rinius Augend[us] / [e]gregius vir a mil[li]t[ari] fratri [pi]ssimo et Matur[in]ia Pia coniugi ca[r]issimo facien[dum] cura[ve]runt / et sub ascia dedicav[er]unt.

they always referred to (*Ulpia*) *Noviomagus* and, as far as we can tell, they always had Roman citizenship.⁸⁶ The earliest reference is in a fragmentary inscription from the very beginning of the 2nd century (B 21), but it is only from about 135 AD onwards that the name appears on a more regular basis (fig. 8).

albeit mostly in abbreviated form (CCAA and CVT), and the rest of the population, who used the terms *Agrippinensis* and *Traianensis* or shortened versions of the town's name such as *Cl(audia) Ara* and *Traiana*. See the useful overviews in Weisgerber 1968, 55–58; Galsterer-Kröll 1972, 115 f.; Schalles 1995, 380–385.

⁸⁶ In a fragmentary *laterculus* from the *castra praetoria* in Rome (*CIL* VI 32627), the names of two soldiers are followed by the abbreviation *Nov* and that of a third one by the somewhat longer form *Novom*. Although these abbreviations may be extrapolated in different ways (e.g. *Noviodunum*, *Noviomagus*) and although *DNP* 8, 2000, 1032 ff., *s.v.* *Noviomagus* (R. Wiegels), lists as many as 8 different towns with the same name (!), it seems very

likely that *Ulpia Noviomagus Batavorum* was meant here. With its typical *-inius* suffix, the gentilicium of one of the men (M. Ingenuinius Super) clearly points to an origin in the Lower Rhine area. Moreover, three of his fellow soldiers serving in the same *centuria* can be identified as originating from Lower Germany as well, two being from the colony at Cologne (*Agrippina*) and a third one from that at Xanten (*Traiana*). It should be noted that the earlier name of the town, oppidum *Batavorum* or *Batavodurum*, in use from the early 1st century until shortly after the Batavian revolt (cf. Tacitus, *Hist.* 5.19–20), had ceased to exist before the bulk of the inscriptions were erected and before Roman citizenship had become widespread among the Batavi.

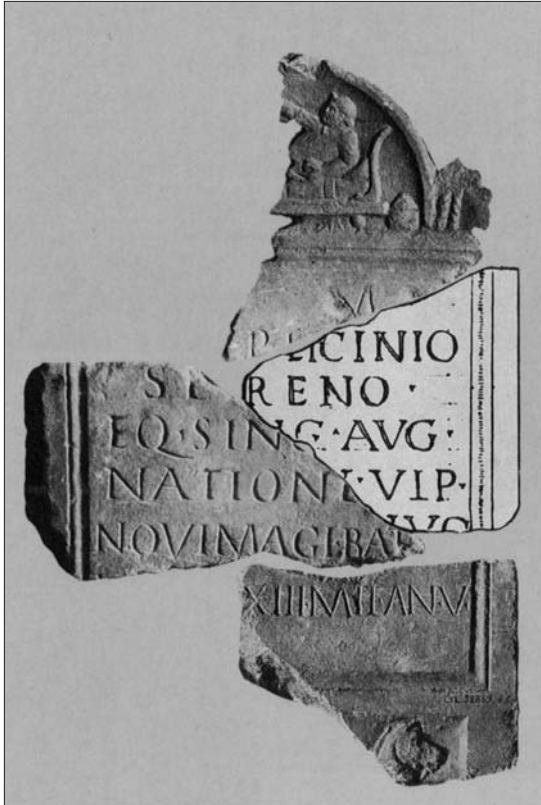

Fig. 8. Epitaph of a Batavian *equus singularis Augusti* mentioning his home town Ulpia Noviomagus (with spelling error!) in conjunction with the ethnic formula *natione Batavus*. Date: 2nd century. Photos and drawing after Speidel 1994a.

[D(is)] M(anibus) / [. Si]mplicinio / Sereno, / eq(uiti) sing(ulari) Aug(usti), / natione Ulp(ia) / Novimagi (sic!) Bata(v)us / [vix(it) an(nos) X]XIII, mil(itavit) an(nos) V (ESA 211).

Finally, for the sake of completeness, we need to mention four cases of redundant formulations containing both the name of the town and the ethnicum, occasionally preceded by *natione*.⁸⁷

What should we conclude from all this? Before drawing immediate conclusions, we first need to ask whether the different formulaic expressions still retained the distinct shades of meaning which their etymology suggests, or whether they had become blurred over time, developing into plain convention. Hybrid formulae combining *natione* or *domo* with the name of a town demonstrate a certain loss of terminological accuracy (cf. fig. 8).⁸⁸ Also the fact that

Batavi in Pannonia used the formulae typical of the area points to the importance of convention. Finally, whether the *origo* was described in terms of membership of the civic community in which the individual was inscribed (*civis Batavus*) or through reference to the capital where most privileges of that membership could be exercised (Ulpia Noviomagus) may have made little difference to the people concerned. In contrast, I would argue that the distinction between the tribal affiliation and self-ascription to a civic community remained critical. To make my point, I will compare the Batavian evidence with that available for the Ubii, Cugerni, Treveri and Tungri.

In the territories of the Ubii and Cugerni, the establishment of Roman colonies in AD 50 and AD 98/99 led not just to an enormous boost for the process of urbanisation, but also – and more importantly – to the social marginalisation of the peregrine sections of the original tribal population, ultimately resulting in their complete disappearance from the epigraphic record.⁸⁹ Thus for the Ubii – with the exception of five *Germani corporis custodes* of the Julio-Claudian bodyguard, all with peregrine status – only one woman and four men, all of them peregrine *equites* from the auxilia, are known (table 2). The woman, of peregrine stock, is known from the funerary monument which her husband had erected close to the Roman road just outside the legionary fort at Neuss. The man himself, a Roman citizen inscribed in the Galerian tribe, must have been garrisoned at the local *castra*. Since he bears no cognomen, the

⁸⁷ B 31, B 41, B 46, B 47.

⁸⁸ While the use of *domo* followed by the name of a town was widespread, the combination of *natione* with a place name is rare. For examples, cf. ESA 211: *natione Ulp(ia) Novi{0}magi Batav(us)*; CIL III 1214 = Krier 1981, no. 55: *domo Augus(ta) Treve(rorum)*; CIL VI 3311 = ESA 728: *nat(ione) Cl(audia) Ara*; CIL VI 36325: tombstone for M.

Sennius M.f. Verus *nat(ione) Agrippinensis* (erected by C. Valerius Messor *nat(ione) Frisiaus*; cf. CIL VI 36324).

⁸⁹ For the treatment of the Ubii after the foundation of the Roman colony, Haensch 1999, 649 f.; Eck 2004, 152 ff. For the Cugerni, Galsterer 1999, 261 ff. esp. 265 f.; for the foundation date of CVT, *ibid.* and the extensive discussion in Geyer 1999, 134–141, esp. 140.

	Find spot	Name	Origin	Unit	Reference
1	Rome	Bassus	<i>nat(ione) Veius (=Ubius?)</i>	<i>Germani corporis custodes</i>	<i>CIL VI 4337 = Bellen B 8</i>
2	Rome	Macer	<i>natione Vein (=Ubius?)</i>	<i>Germani corporis custodes</i>	<i>CIL VI 4339 = Bellen A3</i>
3	Rome	---	<i>nation(e) U[bius]</i>	<i>Germani corporis custodes</i>	<i>CIL VI 8805 = Bellen A19</i>
4	Rome	Postumus	<i>nat(ione) Ubius</i>	<i>Germani corporis custodes</i>	<i>CIL VI 8809 = Bellen A10</i>
5	Rome	Fannius	<i>nation(e) Ubius</i>	<i>Germani corporis custodes</i>	<i>AE 1952, 145 = Bellen A12</i>
6	Moesia inferior	Primus Marci f.	<i>Ubius</i>	<i>Ala Asturum</i>	<i>RGZM 8</i>
7	Châlon-sur-Saône	Albanus Excingi f.	<i>natione Ubius</i>	<i>Ala Asturum</i>	<i>CIL XIII 2613</i>
8	Mainz-Weisenau	Fronto Dregeni f.	<i>natione Ubius</i>	<i>Ala Indiana</i>	<i>AE 1929, 130</i>
9	Cercovika (BG)	Blandus Sing(i)ber(t)i f.	<i>nat(ione) U[b]ius</i>	<i>Ala Bosporanorum</i>	<i>AE 1925, 70</i>
10	Neuss	Louba Gastinasi f.	<i>Ubia</i>	-	<i>CIL XIII 8565</i>

Table 2. Inscriptions mentioning Ubii, with the exception of one woman (no. 10) most likely married to a legionary soldier, all of them *Germani corporis custodes* or peregrine horsemen from the auxilia. All date from the 1st century AD.

inscription can not be much later than the early 40s AD and thus predates the foundation of the colony. The soldier's tribe, together with the monument's early dating, points to an origin from Northern Italy. The couple would then be a fine example of the process of intermarriage between first generation settlers from the Mediterranean and local Ubian women.⁹⁰ As for the four horsemen, all completed their term of service within the 1st century. According to the military diploma issued to him in AD 99, one of them was conscripted as late as AD 74, proving that the Ubian tribal affiliation remained in use for a while after the colony's foundation, at least in the official record-keeping of the Roman army. As demonstrated by the early 2nd-century example of M. Ulpius Victor, a veteran of the *equites singulares* from Rome, those Ubii who acquired Roman citizenship and were thus able to associate themselves with the new colonial town, did so eagerly.⁹¹

Although the evidence for the Cugerni is much sparser, a largely similar development may be seen here. Actually, we have only one inscription in which someone claims Cugernian origin (table 3). The inscribed monument, a funerary stele for a peregrine horseman from the auxilia, is typologically dated to the mid-1st century, thus clearly before the foundation of the Colonia Vlpia Traiana that was to replace the *civitas Cugernorum*.⁹² Apart from the Cugerni, the Baetasii are another tribal group conventionally located within the territory that was later controlled by Trajan's colony.⁹³ Although their exact status is uncertain, they were at least used for military recruitment: during the Batavian revolt, they supported Claudius Labeo with an irregular unit of young men, and a regular Cohors Baetasiarum is epigraphically

⁹⁰ The fort at Neuss was occupied by Legio XX under Tiberius and Legio XVI under Claudius. A veteran from Legio XX, originating from Veleia and inscribed in the Galerian tribe, settled in the urban centre of the colony itself. He may be another example of this phenomenon: *CIL XIII 8286 = RSK 223*.

⁹¹ *CIL VI 3311 = ESA 728*. Victor may have been conscripted as a Ubian, won Roman citizenship when selected for the imperial guard and ended up being assigned an origin from the colony at his death. This background perhaps explains the hybrid expression used to denote

his origin; cf. note 88 above and Eck 2004, 160. Cf. also Tacitus, *Germ.* 28 on the Ubii who 'preferred to be called Agrippinenses after the name of their foundress (Agrippina)': *libentius Agrippinenses conditoris sui vocentur*.

⁹² *CIL III 9727* (Trilj-Gardun, HR); Rinaldo Tufi 1971, no. 10 and fig. 3.

⁹³ They are usually discussed in close association with the Sunuci – who, in contrast, are unattested in the epigraphy – and are located between the rivers Meuse and Niers. Cf. Tacitus, *Hist.* IV, 66; *CIL XIII*, p. 598 f.; Galsterer 1999, 253 f.

	Find spot	Name	Origin	Unit	Reference
1	Rome	Phoebus	<i>nat(ione) Baetesius</i>	<i>Germani corporis custodes</i>	<i>CIL VI 8808 = Bellen A21</i>
2	Rome	M. Arrad(ius) Priscus	<i>Traianenses Baetasius</i>	<i>Equites singulares Augusti</i>	<i>CIL VI 31139 = ESA 3</i>
3	Rome	M. Ulp(ius) Optatus	<i>Traianensis Baetasius</i>	<i>Equites singulares Augusti</i>	<i>CIL VI 31139 = ESA 3</i>
4	Rome	C. Iul(ius) Crescens	<i>Traianensis Baetasius</i>	<i>Equites singulares Augusti</i>	<i>CIL VI 31139 = ESA 3</i>
5	Trilj-Gardun (HR)	Melvadius	<i>domo Cugernus</i>	<i>Ala Claudia Nova</i>	<i>CIL III 9727</i>
6	Mainz	Annauso Sedavonis f.	<i>cives Baetasius</i>	<i>Ala II Flavia</i>	<i>CIL XIII 7025</i>

Table 3. Inscriptions mentioning Cugerni or Baetasii, all dating from the 1st or early 2nd century.

known from AD 103 onwards.⁹⁴ We know of five *cives Baetasii*, all of them horsemen (table 3). Two are known from their 1st-century tombstones,⁹⁵ while the names of the other three have been preserved on a large votive altar from the headquarters of the imperial horse guard in Rome. The altar was a collective dedication by 48 *equites singulares Augusti* in commemoration of their honourable discharge in AD 132. While the names of those responsible for the dedication were listed individually on the side panels,⁹⁶ four also mentioned their origin, three of which read as *Traianensis Baetasius*. With the foundation of the Colonia Vlpia Traiana in AD 98/99, the territory of the Baetasii had apparently been allocated to the newly established veteran colony.⁹⁷ As the consular dates on the top of the *laterculi* indicate, the Baetasii were placed on the rolls in AD 104, i.e. a few years after the colony had been established, when building activity in the new town was in full swing. One of the Baetasii – together with 37 of his comrades! – bore the praenomen and gentilicium of Trajan, showing that this emperor had granted him Roman citizenship on admission to the imperial horse guard.⁹⁸ Against this background, it is easy to understand that he and his fellow tribesmen felt a kind of dual identity: having been born as Baetasii and enrolled as such in the auxilia, they received Roman citizenship upon transfer to the emperor's guard and finally completed their military service to become full citizens of the Colonia Vlpia Traiana, the town founded by the emperor to whom they owed their citizenship. The next generation of Baetasii either no longer felt this problem of loyalty or, from the subordinate position attributed to them, judged it more advantageous to mask their 'true' origin and to publicly declare themselves *cives Traianenses*, thereby depriving us of any prospect of tracing their origin.

So unless we have been misled by the peculiar characteristics of the epigraphic evidence, in the case of both the Ubii and the Cugerni (as well as the Baetasii), the old exclusive tribal identity of the 1st century quickly made way for an inclusive civic identity centred upon on the new colonial town. This is exactly what we would expect, given the social implications of large-scale colonisation by a socially privileged group. The question then remains as to what form this development took in other districts that did not undergo such forms of colonisation and veteran settlement. Here the comparison with the Treveran and Tungrian material, which reveals two different trajectories, may be instructive.

⁹⁴ Alföldy 1968, 77 and 84.

⁹⁵ *CIL VI 8806 = Bellen A 21: nat(ione) Baetesius* (Neronian); *CIL XIII 7025 (Mainz) = Boppert 1992, no. 34: cives Betasii[s]* (Flavian).

⁹⁶ *CIL VI 31140 = ESA 3.*

⁹⁷ Galsterer 1999, 254, 266; Raepsaet-Charlier 1999, 318 f.; for the Roman character of the colony, i.e. with veteran settlement, Galsterer 1999, 251; Vittinghoff 1994, 85, 104.

⁹⁸ Whether the other two, named M. Arrad(ius) Priscus and C. Iul(ius) Crescens, already had citizenship when they joined the army, remains an open question. For the continued debate on the citizenship of the imperial horse guard, see Stylow 1994, with critical remarks by Raepsaet-Charlier 2001, 432 f.

Specification of origin	I A	I B	II	IIB / IIIA	III	total
<i>natione Trever</i>	5 (0)		1 (1)		1 (1)	7 (2)
<i>domo Trever</i>	1 (1)	1 (0)				2 (1)
<i>domi Trever</i>			1 (1)			1 (1)
<i>Trever</i>	3 (1)	9 (5)	8 (7)	7 (7)		27 (20)
<i>civis Trever</i>		3 (2)	7 (7)	11 (11)	4 (4)	25 (24)
<i>domo Augusta Treverorum</i>			1 (1)			1 (1)
total	9 (2)	13 (7)	18 (17)	18 (18)	5 (5)	63 (49)

Table 4. Specification of origin in inscriptions by Treveran individuals between the first half of the 1st and the 3rd century AD. The number of people who possessed Roman citizenship is given in brackets (data from Krier 1981; his nos 9, 17, 27, 28, 33, 52 and 62, for which the origin has not – or with not enough detail – been preserved, have not been included in this table).

The evidence available for the Treveri (table 4) reveals a trend which in many respects is similar to that described for the Ubii and Cugerni, but with the important difference that – unlike the latter tribes – the Treveri were not driven from their territory and marginalised, but remained centre stage. While the near absence of references to the *caput civitatis* may be difficult to explain,⁹⁹ the high frequency of the formula with *civis* suggests that the Treveri evolved into a flourishing civic community as quickly as did the colonial towns on the Rhine.¹⁰⁰

In this respect, the Treveri show a marked difference from the Batavi. It is not simply that the term *civis* appeared late (not until the 3rd century) in the inscriptions of the Batavi (cf. table 1) and remained rare (only featuring twice) whereas the formula *natione* continued to be used frequently, there are also distinct differences with regard to geographical distribution and the ratio of civilians to military men. About three quarters of the inscriptions erected for and by Treveri stem from the ‘civilised’ provinces of the empire’s interior (fig. 9). Not surprisingly, many of the people involved had a civilian background. With nearly equal numbers of inscriptions for Treveri and Batavi, such sharp contrasts are unlikely to have been determined by chance. Instead, they support the idea that the high number of military personnel in the Batavian sample, as well as their much stronger identification with the ethnic group than with the civic community, reflects historical reality.

Most Batavians whom we happen to know of are soldiers, with auxiliaries and troopers from the imperial horse guard accounting for more than 75 % of the inscriptions. Due to the practice of ethnic recruitment, auxiliary soldiers tended to retain their tribal affiliation much longer than their legionary counterparts, a tendency that is perhaps corroborated by the Roman army system of recording the soldiers’ homes.¹⁰¹ Instructive for the distinct mental maps of auxiliaries and legionaries are the 13 inscriptions of 1st-century legionary soldiers whom we know were recruited from Gaul. While they all, much like their Italian colleagues, refer to an urban centre to indicate their provenance,¹⁰² their peregrine

⁹⁹ It features only once (cf. note 88 above); perhaps the name Augusta Treverorum offered too few options for abbreviation (cf. note 85)?

¹⁰⁰ I consider the simple ethnicum *Trever* comparable to the simple *Agrippinensis* or *Traianensis*, and in both cases am inclined to understand a preceding *civis* rather than *natione*.

¹⁰¹ Cf. notes 27 and 29 above.

¹⁰² Syme 1938, esp. 186, note 8; Forni 1953, 181 f.; idem 1974, 370: Lugdunum (three men), Augustonemetum (three), Augustodunum (two), Autricum (two), Burdigala (two) and Andematunnum (one).

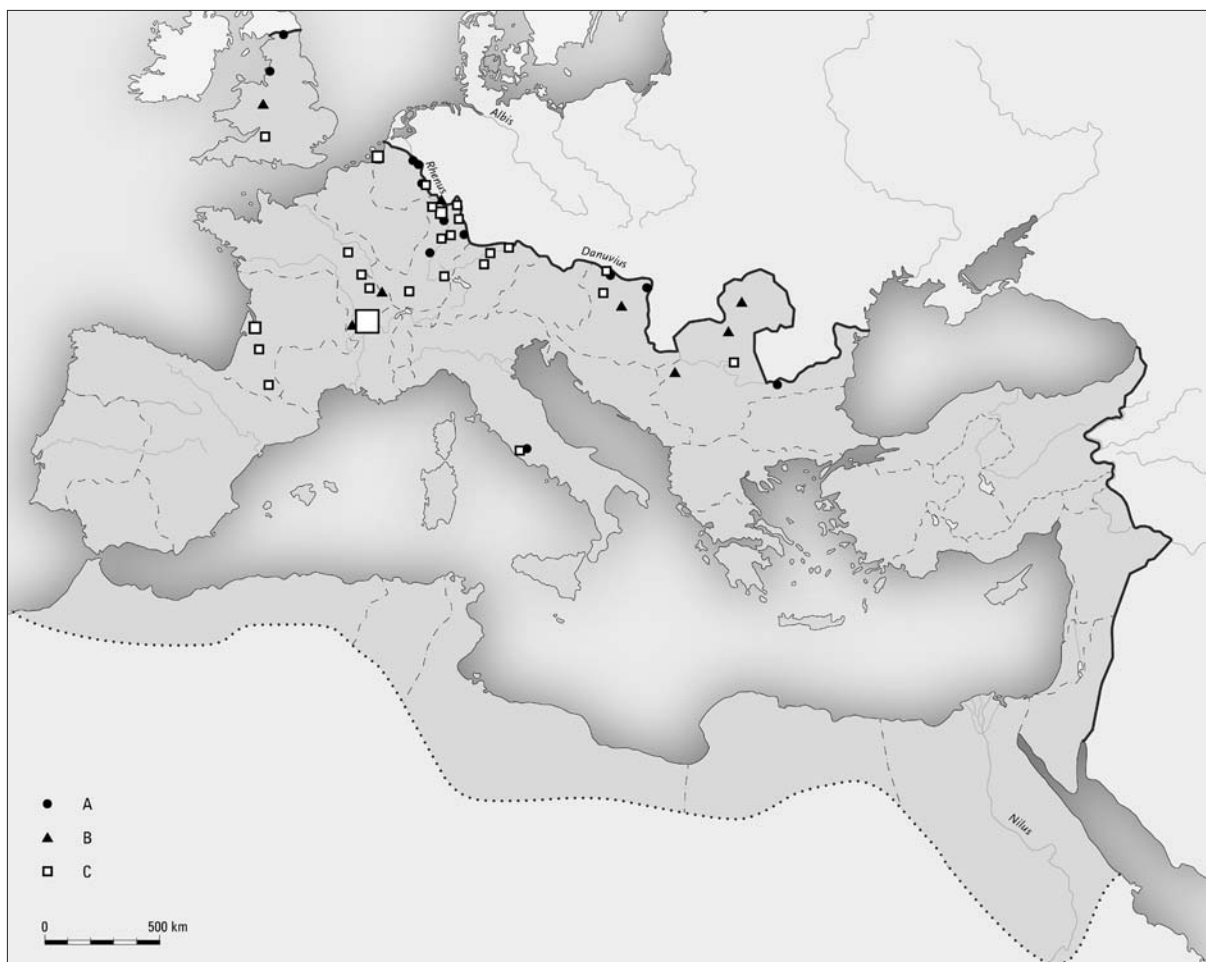

Fig. 9. Distribution of inscriptions including Roman military diplomas which explicitly mention individuals of Treveran descent (data after Krier 1981 with one addition: Vindolanda).

A active auxiliary or legionary soldier; B veteran soldier; C civilian (small symbol: 1-2 individuals; medium size symbol: 3-4 individuals; large symbol: 5 or more individuals).

fellow countrymen from the auxilia also retained their tribal affiliation (Haeduus, Arvernus, Lingo).¹⁰³ Against this background, the significant difference between the Treveran and Batavian evidence may be primarily explained by the exceptionally heavy recruitment for the auxilia among the Batavi and the disproportionately high representation of auxiliary soldiers in the available epigraphic evidence. What is most striking then is that despite their *civitas* having been promoted to the rank of *municipium* in the early 2nd century, and despite the fact that most Batavian auxiliaries had Roman citizenship from the 2nd century on, they continued to express their roots in terms of tribal affiliation. If a certain reluctance to switch to self-ascription in civic terms may have been widely shared by auxiliaries from different tribes, the striking unresponsiveness of Batavians demands an explanation. Since the label 'Batavian' became almost synonymous in army circles with military virtues such as 'manliness', 'bravery', and 'martiality',

¹⁰³ As Ronald Syme noted (1938, 189), among the towns represented are a Roman colony, three tribal capitals of *civitates* which according to Pliny (*NH* IV 106) were federated (*foederatae*) i.e. Aedui, Carnutes and Lingones,

whereas the *civitates* of the remaining three were free (*liberae*). Most of the legionary soldiers seem to have been granted Roman citizenship upon enrolment.

	Find spot	Name	Origin		Unit	Reference
1	Ovilava/Wels (A)	Chartius Pagudani (f.)	<i>natione Tunger</i>	<i>eques sing(u)l(aris)</i>	Ala Augusta	AE 1968, 412; CSIR III.3, 49
2	Rome	M. Ulpius Felix	<i>natione Tunger</i>	<i>mirmillo</i>	-	CIL VI 33977
3	Rome	[---]inus	<i>Tung(er)</i>		Cohors Pr	CIL VI 32623
4	Neuss	Oclatius Carvi f.	<i>Tunger</i>	<i>signif(er)</i>	Ala Afrorum	AE 1926, 67
5	Semriach (A)	Host(ilius)	<i>Tunger</i>	father of soldier from Coh VII Pr	-	CIL III 5450
6	Budapest	Ti. Claudiu[s L]aedi f. A[---]ger	<i>[Tun]ger</i>	<i>e[q(ues)]</i>	?	CIL III 15163 = RHP 128
7	Guljanci (BG)	Sulpicius Massa		<i>veteranus</i>	Ala Hispanorum	CIL III 12361
8	Adamklissi	[---] f.	<i>Tun(ger)</i>			CIL III 14214, fragm. V, l. 3
9	Adamklissi		<i>Tung(er)</i>			<i>ibid.</i> , l. 12
10	Adamklissi		<i>Tung(er)</i>			<i>ibid.</i> , l. 13
11	Mainz (Zahlbach)	Freioverus Veransati f.	<i>cives Tung(er)</i>	<i>eq(ues)</i>	Cohors I Asturum	CIL XIII 7036

Table 5. Inscriptions mentioning Tungri. Based on data in Nouwen 1997, 156 f.

Batavian *auxilarii* probably had good reasons for preferring to parade themselves as ‘Batavian’ rather than as ‘*civis Noviomagensis*’.¹⁰⁴

Finally, the Tungri more or less follow the example of the Batavi (table 5). With four units of infantry and one of cavalry raised from their midst, they number among the small group of tribes that were exploited primarily for their manpower: with only two exceptions, all Tungrians attested to in the inscriptions served in the army.¹⁰⁵ Although both the Batavian and Tungrian communities were granted municipal rights, they never achieved the same degree of urbanisation as the Roman colonies of the Agrippinenses and Traianenses, nor that of the Latin colony of the Treveri. In other words, if municipalisation and enfranchisement normally contributed to the dissolution of traditional ethnic bonds, insofar as the epigraphic evidence can tell us, this was not the case with the Batavi and Tungri.¹⁰⁶

7 POWER, TRADITION AND ORIGIN MYTHS

An important aspect of ethnicity is a shared belief in a common origin. If tribal communities in the frontier of the Roman Northwest experienced different forms of intervention, causing some to retain a strong tribal affiliation and others to adopt a new civic identity, a final question that I want to discuss here is how these different trajectories affected origin myths. Did they continue in the way they had

¹⁰⁴ The three Batavians from the Praetorian Guard (see above, note 86) are the exceptions.

¹⁰⁵ The father of a soldier from the Cohors VII praetoria (CIL III 5450), and a former *mirmillo* (CIL VI 33977) are the exceptions. Much like the Batavi (and quite unlike the Treveri), Tungrians are only found in the frontier provinces along the Rhine and Danube as well as in

Rome. For further discussion, cf. Nouwen 1997, 157–163, 261–265, 298 f.

¹⁰⁶ The only indication that Batavi and Tungri to a certain extent underwent a similar transition from self-ascription to an ethnic group to self-definition in civic terms is the isolated use of self-designations such as *Batavus* or *Tunger*, omitting the preceding formula *natione*.

before, or were they adapted in some way or replaced by new stories? In other words, was the creation of a new identity group simply a matter of changing names¹⁰⁷ or did it go hand in hand with a redefinition of existing origin myths? From a theoretical point of view, the latter seems much more probable, but the evidence is flimsy and leaves much open to debate. We will first discuss the Ubii, then the Traianenses and finally the Batavi.

Two passages in Suetonius' biography of Vitellius referring to a Mars sanctuary at Cologne provide some leads for the Ubii. First, after Vitellius was proclaimed emperor by the Cologne garrison, he was carried around, according to Suetonius, 'holding the unsheathed sword of the Deified Julius, which someone had taken from a shrine of Mars and had handed him during the first congratulations'.¹⁰⁸ Second, on inspection of the battlefield where his adversary Otho had committed suicide, Vitellius 'declared that he [Otho] deserved such a mausoleum, and sent the dagger with which his rival had killed himself to the colony of Agrippina, in order to be dedicated to Mars'.¹⁰⁹ In addition to these two references, there is a synodal charter from Cologne dating from AD 887 in which mention is made of a *forum Iulii*.¹¹⁰ Although we don't know whether these individual messages refer to one and the same sanctuary, what we do know about the representation of the Julian ideology of descent suggests that this would certainly fit the model. It immediately calls to mind the Mars Ultor sanctuary on the Forum of Augustus in Rome, where the Julian house used an important sculptural programme to trace back its descent, via the Trojan hero Aeneas and the wolf twins Romulus and Remus, to Venus and Mars.¹¹¹ Local archaeologists have tried to identify the sanctuary with partly excavated impressive stone foundations located at one of the central *insulae* south of the *decumanus maximus* and west of the walled circuit that ran along the Rhine front, but the problem is far from being settled.¹¹²

If we accept, as the Julian descent ideology suggests we should, that the Mars sanctuary and the *forum Iulii* were interconnected, when could this complex have been built? Suetonius of course only provides a *terminus ante quem* of AD 69. Since the earliest contacts between the Ubii and the Julian house date as far back as Agrippa or even Caesar,¹¹³ and since the bonds between these two parties were renewed time and again by successive representatives of the imperial family such as Augustus, Germanicus and Caligula, we may in theory assume any date between the earliest settling of the Ubii during one of Agrippa's governorships and the turmoil of the Batavian revolt in AD 69. According to Galsterer, a cult for Mars Ultor, the avenger of Caesar's assassins, would fit better in the Augustan era than in the second half of the 1st century.¹¹⁴ While the reign of Augustus certainly provides a good historical context from the Roman point of view, it probably does so less from the Ubian. We are unlikely to see dramatic changes in the religious traditions of the Ubii as long as the Ubian tribal identity group continued to exist. Since the sparse evidence we have points to Hercules rather than Mars as the principal male god of the Ubian pantheon,¹¹⁵ I would argue that the founding of the colony in AD 50 provides a context which better

¹⁰⁷ Cf. note 91 above.

¹⁰⁸ Suet., *Vit.* 8: *strictum Divi Iuli gladium tenens detractum delubro Martis atque in prima gratulatione porrectum sibi a quodam.*

¹⁰⁹ Suet., *Vit.* 10: *dignum eo mausoleo ait, pugionemque, quo is se occiderat, in Agrippinensem coloniam misit Marti dedicandum.*

¹¹⁰ Hellenkemper 1972/73, 104, with note 10.

¹¹¹ Zanker 1988, fig. 149; Derks 1998, 30 ff.

¹¹² Hellenkemper 1972/73; Seiler 1992, esp. 50 f. In his recent evaluation of the architectural remains, Irmeler (2004) identifies the site with the *ara Ubiorum*. Since the remnant architectural blocks cannot be dated before the

Flavian period, it remains as yet unclear what evidence there is for the earliest phase of the *ara*, a point which is also neglected by Eck (2004, 88 f.). Given the fact that the nearby town gate on the *decumanus maximus* was designated *porta Martis* since at least as early as the first half of the 11th century, the temple's location, if its identification with the recently excavated remains is rejected, can not be far away.

¹¹³ Cf. Speidel 1994b, 12 f.; Roymans 2004, 56 ff.

¹¹⁴ Galsterer 1990, 124; similarly, Haensch 1999, 643.

¹¹⁵ As we do not have a single inscription to Mars from the territory of the Ubii as opposed to several for Hercules,

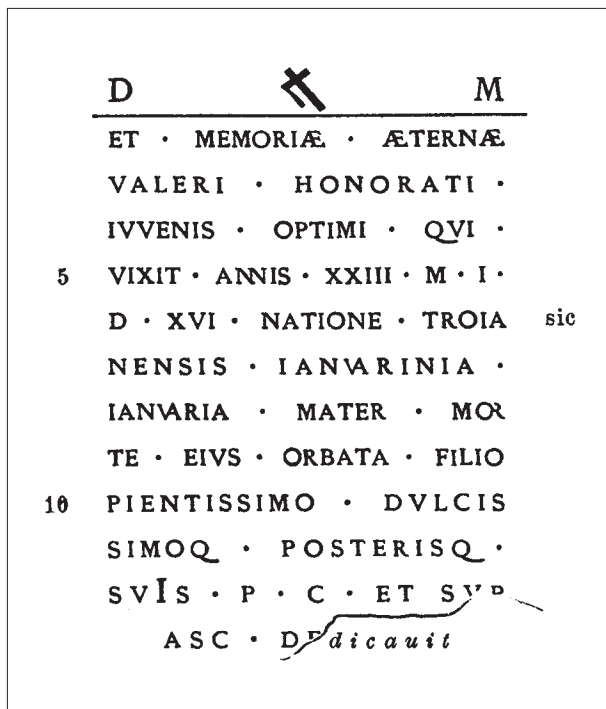

Fig. 10. Funerary monument from Lyon put up by the deceased's mother in commemoration of her beloved son Valerius Honoratus, who is said to have been of Trojan descent (*natione Troianensis*).

D(is) M(anibus) / et memoriae aeternae / Valeri Honorati, / iuvenis optimi, qui / vixit annis XXIII m(ense) I / d(iebus) XVI, natione Troia/nensis. Ianuarinia / Ianuaria, mater, morte eius orbata, filio / pientissimo dul/cissimoq(ue) posterisq(ue) / suis p(onendum) c(uravit) et sub / asc(ia) de[dicavit] (CIL XIII 2034; now lost).

accounts for the introduction of new public cults and the consecration of new sanctuaries. As the late republican colonial charter of the Spanish town of Urso makes clear, yearly decisions as to which cults should be public had to be taken by the colony's *duoviri* within ten days of their nomination.¹¹⁶ This would also have been true for the first couple nominated immediately after the colony's foundation. Promised

within days after the initial foundation act, the actual completion of a new temple could have taken place in the decades that followed.

So how and when did 'Caesar's' sword get to Cologne?¹¹⁷ Again, there are many options open to us and we can only guess. Is it logical to think that it happened in the early days of the Oppidum Ubiorum, with Agrippa as intermediary? Possibly, but this would have been a great honour for a community that had not yet proven exceptional bonds of loyalty. Could the foundation of the Ara Ubiorum have been a fitting occasion? Perhaps, but although the altar was in Ubian territory, its focus was far broader, and it was not devoted to the cult of Mars, but to that of Rome and Augustus. In my view, the most probable occasion is again the foundation of the colony itself. In the new sanctuary of Mars, probably on or adjacent to the *forum Iulii*, the weapon would have been an important symbol. The cultural biography of the sword that had played such a fundamental role in the history of the Julian family and the empire as a whole, whether 'real' or 'fictive', made it an important and valued object that could invest the new sanctuary with a lived history and a mythical past, linking the colony with the legends of Troy, through the Julian family.¹¹⁸ While that would have significantly enhanced the colony's reputation and prestige as well as its Roman identity, the new sanctuary with its imported *sacrum* could at the same time embody

the Gallic model of a local male god who became associated or identified with Mars (cf. Derks 1998, 94 ff) seems less probable here. I do concede, however, that none of the Hercules inscriptions, mostly dating from the 2nd and 3rd centuries, provide conclusive evidence, as they may equally result from adoption of the cult by the military. On the Lower Rhine Hercules cult, see Roymans this volume.

¹¹⁶ Crawford 1996, 393 ff.; Scheid 1999, 389 ff.

¹¹⁷ The question of whether this sword 'really' did once

belong to Caesar (or his murderers?) is irrelevant here in my view. For a discussion of the tensions between history and myth in Roman memory, cf. Timpe 1996.

¹¹⁸ Some of the most beautiful sculptural representations of Aeneas' flight from Troy are known from Cologne itself (Noelke 1976). They once belonged to rich funerary monuments that lined the main streets leading from the town. They show how the Trojan legend was appropriated by local inhabitants for self-representations on their private monuments.

the long-established bonds of friendship between the Ubii and the Julian house, which had begun with the former owner of the object. A member of the imperial family probably acted as an intermediary in bringing ‘Caesar’s’ sword to its new location, perhaps the emperor Claudius, or Agrippina herself, scion of the *gens Iulia*, granddaughter of the founding father of the Oppidum Ubiorum, the town where she was born, and foundress of the colony.¹¹⁹ In this way, the new sanctuary, the imported *sacrum* and the refashioning of the mythical past all contributed to forge a new communal identity for the Agrippinenses, in which both foreign settlers and former Ubii could feel at home.

We have even fewer clues when it comes to the origin myths of the new identity group of Traianenses. But in general terms, since any Roman colony was in fact simply a part of Rome abroad, it seems no more than logical that the colony at Xanten, like all others, traced its origins back to those of Rome itself, and eventually to Aeneas and Troy. Two pieces of evidence may be adduced to corroborate this hypothesis. First, according to a late medieval story whose nucleus seems to go back as far as the 7th century AD, Xanten was founded by Priamus, the grandson of Troy’s famous king, hence its other name of Little Troy.¹²⁰ Whereas this story could be simply explained away as a medieval invention that played on the similarity between the two place names, the same cannot be said of the second piece of evidence which firmly dates to the Roman period. In a funeral inscription from Lyon, the deceased is erroneously said to have been *natione Troianensis*, ‘of Trojan descent’, instead of the more correct *natione Traianensis* (fig. 10).¹²¹ Although the evidence in itself may not be decisive, the misspelling is certainly revealing of the omnipresence of the Trojan origin myth in the early 3rd century.

Finally, let me devote a few words to the Batavi, Cananefates and Tungri. In contrast to the *civitates* of the Ubii and Cugerni, no Roman colony was established on their territories. The three *civitates* were granted municipal rights in the last years of the 1st century or during the 2nd century, but unlike the foundation of Roman colonies, such legal promotions did not entail a change of name as we have seen for the Ubii and Cugerni. Even though it wouldn’t have been too difficult to create new self-ascriptive labels derived from municipal titles like *Municipium Ulpium Batavorum* or *Municipium Aelium Cananefatium*, this did not happen.¹²² Although the sample of inscriptions at our disposal is small and therefore certainly not representative in all respects,¹²³ the main reason for this difference must have been the absence of a sudden, massive influx of ‘foreign’ veterans typical of Roman colonies.¹²⁴ As the *Traditionskern* of these communities remained more or less intact,¹²⁵ there was no need for change in this sense. Moreover, a name like *Colonia Augusta Treverorum*, which lacked distinctive titles, indeed left few other possibilities for designating origin than the simple *Trever(i)*.

¹¹⁹ Iulia Agrippina was born in the gens Iulia on 6 November AD 15 or 16 in the army camp near Cologne while her father Germanicus was campaigning in Germany. As the daughter of Agrippa’s daughter, she was called after both her grandfather and her mother, Vipsania Agrippina (Agrippina Maior). After marrying Emperor Claudius in AD 49, she persuaded her husband to promote her birthplace to the same rank as his own. Kienast 1996, 94; Haensch 1999, 649.

¹²⁰ Borgolte 2001, 192, 195, and esp. 197, Abb. 207. In 1047, Emperor Heinrich III signed a deed of gift with *Actum Troiae quod et Sanctum dicitur*.

¹²¹ *CIL* XIII 2034.

¹²² Batavi never became *Ulpenses*, and Cananefates never *Aelienses*. An exception is the inscription on a sarcophagus from Brigetio in Pannonia (*CIL* III 4279), in which

the army doctor from the Legio I Adiutrix designates his wife’s origin as *domu Foro hadriensi provincia Germania inferiori*.

¹²³ We may question, for instance, whether the imperial epithets of the granting emperor were omitted for reasons of space from inscriptions recording the municipal status for the Batavi and Tungri (cf. *AE* 1958, 38; 2001, 1488 and 1499; 1994, 1279; also note 85 above). Why should we not assume that the full official title of the Batavian *municipium* was, say, *Municipium Ulpium Batavorum*?

¹²⁴ *Contra* Haalebos 2000, 38, who assumed organised veteran settlement at Nijmegen.

¹²⁵ For a summary of the recent discussion on the concept of *Traditionskern*, first coined by Reinhard Wenskus, see Roymans 2004, 3 and 257–259; also introduction this volume.

As far as the representation of their roots in the mythical past is concerned, it is perhaps also understandable against the above-sketched background that a dramatic reorganisation of the cult did not occur here as it did in Cologne. This is not to say that there were no changes (as I have demonstrated elsewhere, the public cults of these communities were thoroughly Romanised),¹²⁶ but a traditional core was retained. The most important aspect was perhaps that of continuity of place, which rendered unnecessary imports such as the *sacrum* of the Mars sanctuary at Cologne.

8 CONCLUSIONS

1. In the epigraphic record of the Roman empire, forms of personal affiliation differed according to time, space and context. Whereas ethnic or tribal affiliations were common throughout the Lower Rhine frontier during the conquest and pacification of the early Imperial period, under the Pax Romana these were generally replaced by formulae using geographical provenance or political-administrative inscription in a certain *civitas*; by contrast, after the collapse of the *limes* and the civic system of administration, tribal or ethnic identity once again became important in the later Empire.
2. In contrast to the general development described above, self-ascription in civic terms remained a rare phenomenon among the Batavians even in the 2nd and 3rd centuries. This may be due to the strong military imprint of Batavian society, as is evident from the epigraphic sources in which soldiers from the auxilia or the imperial body guard make up about 75 % of all known inscriptions erected by or for Batavians. If auxiliarii generally retained a tribal identity into the 2nd and 3rd centuries, partly as a result of the bureaucratic rules that governed the recording of soldiers' homes in Roman army files, the typical outlook of Batavian society may even have reinforced this tendency among the Batavians. Here, the label 'Batavian' may have become synonymous with typical military virtues such as 'manliness', 'bravery', and 'martiality', and as these became an important source of pride, Batavian auxiliarii preferred to buck the trend and present themselves as '*Batavus*' rather than '*civis Noviomagensis*'. The implication is that the social integration of the non-elite Batavian auxiliary soldiers was at best partial and cannot be called a success in all respects.¹²⁷
3. In the inscriptions of the Ubii and Baetasii, the disappearance of the exclusive tribal affiliation in favour of colonial self-definitions such as Agrippinenses or Traianenses signals the successful, rapid integration of the deduced veterans into a new inclusive identity group at the *civitas* level, which identified itself with members of the ruling imperial family. A decisive factor behind this success may have been the granting of *conubium* to the veterans and their sons, thereby favouring the practice of intermarriage. The foundation of the Roman colonies, with the expulsion, expropriation and legal exclusion of at least part of the old indigenous population, must have meant a sharp caesura in the history of the old tribal population. New origins will have been invented which linked up with the history of the imperial family and extended the 'mytho-history' of the new settlement far beyond the date of its actual foundation.
4. In contrast to the settlement of Roman colonies in the tribal areas of the Ubii and Cugerni, the simple promotion of the *civitas* of the Treveri to the status of a Latin colony and that of the Tungri and Batavi to the status of *municipium* did not bring about a massive influx of foreigners or a fundamental change in the towns' names, nor a radical change in existing origin myths. Whereas ethnic affiliations

¹²⁶ Derks 1998, 94 ff.

¹²⁷ Supposed high numbers of returning veterans (cf. Derks/Roymans 2006; Nicolay 2007) and – if the sparse epigraphic evidence is any indication – the dominance of endogamous

marriage (cf. B 28-29, B 65, and B 66-D 15) will have enhanced rather than offset this divergent development.

of the type *natione Trever* or *natione Tunger* were replaced among the Treveri and Tungri by *civis Trever/Tunger* or simply *Trever/Tunger*, the majority of the Batavi continued to use the tribal affiliation in the 2nd and 3rd centuries, even if the community had long been promoted to municipal status and the men concerned had Roman citizenship. An attractive explanation is that the fame of the tribal name of the Batavi and its associated qualities was so strong that these men preferred to promote themselves as *Batavi* – or perhaps as *natione Batavus Ulpia Noviomagus* or *Ulpia Noviomagi Batavus* – rather than as *Noviomagenses*.

5. The institutionalisation of tribal names in both the designation of army units conscripted among subjected tribes, and of administrative districts, towns and regions (*insula Batavorum*) contributed to a ready and – as far as we can tell from our limited sources – fairly ‘universal’ acceptance of Rome’s ethnic labels by its subjects. One of the firmest pieces of evidence for this impact is the remarkable correspondence between the ways in which soldiers’ homes were recorded in documents of the Roman army bureaucracy par excellence, i.e. Roman military diplomas, and in private inscriptions of individual soldiers and veterans.
6. Ethnic consciousness at the level of the individual was especially marked in the event of death in a foreign country. The funeral constituted an occasion when friends, relatives and fellow countrymen gathered to commemorate the deceased, explicitly referred to common roots, and sought consolation together for the loss of the beloved friend or relative who had died abroad. Ethnic group solidarity, on the other hand, is especially apparent in collective dedications to the patron gods of the home area, quite a few of which were made by ethnic enclaves within Roman army units. Such acts of worship were complementary to the army’s corporate religion and, apart from periods of social stress, had an integrative rather than divisive impact on the army’s corporate identity.
7. Despite the reception of former tribal groups within its global limits and the breaking up of traditional boundaries, it is perhaps the paradox of an expanding empire that individual subjects, rather than identifying as citizens of the broader world community they had become part of, continued to identify with their localised origin, albeit in political-administrative or geographical rather than ethnic terms. One notable exception are Roman senators and their off-spring.¹²⁸ Legally tied to the imperial capital at Rome and officially denied any origin other than Roman, they had to mask their personal ties with their home town for the sake of the ideology of a single united empire. Although such legal decisions reflect the emperor’s concern to preserve the ‘Roman’ identity of the empire, it is doubtful whether the Roman self-understanding of senators really did go as far as imperial ideology suggests, and that they in all circumstances neglected to follow their heart.¹²⁹ But this is perhaps another matter, one that lies beyond the scope of this contribution.

¹²⁸ According to Solin (1993, 31–32), Roman senators never made their origin explicit. Throughout the empire only three exceptions to this rule are known: *CIL VIII 2752 (Mantua)*; *AE 1954, 138 (ex Cappadocia)*; and possibly also the fragmentary inscription *CIL II 2666*, for which an

origo [*Mantu*]a has been reconstructed; cf. also Alföldy 2005, 57, note 20.

¹²⁹ Kriekhaus 2001.

ABBREVIATIONS

AAS	Amsterdam Archaeological Studies
AE	<i>L'Année Épigraphique</i>
Bellen	Bellen 1981
CIL	<i>Corpus Inscriptionum Latinarum</i>
CSIR	Corpus signorum Imperii Romani
ER	Byvanck 1935
ES	Epigraphische Studien
ESA	Speidel 1994a
HABES	Heidelberger althistorische Beiträge und epigraphische Studien
IDR	<i>Inscriptiones Daciae Romanae / Inscriptions de la Dacie romaine</i> , Paris 2001–
IK	Inschriften griechischer Städte aus Klein-Asien
IJug	<i>Inscriptiones Latinae quae in Iugoslavia ... repertae et editae sunt</i> , Ljubljana 1963–1986
ILN	<i>Inscriptions Latines de Narbonnaise</i>
KJFV	<i>Kölner Jahrbuch zur Vor- und Frühgeschichte</i>
KJ	<i>Kölner Jahrbuch</i>
Mrozewicz	Mrozewicz 1999
ND	<i>Notitia dignitatum</i> , editio O. Seeck, Berlin 1876
PME	<i>Prosopographia militiarum equestrium quae fuerunt ab Augusto ad Gallienum</i> (6 vols), Leuven 1976–2001
RGZM	Pferdehirt 2004
RHP	Lörincz 2001
RIB	Collingwood, R.G./R.P. Wright, 1965–1995: <i>The Roman inscriptions of Britain</i> , Oxford/Gloucester
RIU	<i>Die römischen Inschriften Ungarns</i> , Budapest 1972–RMD
RMD	<i>Roman Military Diplomas</i>
RSK	<i>Römische Steininschriften aus Köln</i>
Stuart	Stuart/Bogaers 2001
TV	Bowman/Thomas 1994–2003
Wierschowski	Wierschowski 2001
ZPE	<i>Zeitschrift für Papyrologie und Epigraphik</i>

REFERENCES

- Abbink, G.J., 2001: *Identiteit, strijd en continuïteit in trans-modern Afrika. Een kritisch-realistische benadering*, Amsterdam (inaugural address VU University Amsterdam).
- Alföldy, G., 1968: *Die Hilfstruppen der römischen Provinz Germania Inferior*, Düsseldorf (ES 6).
- Alföldy, G., 2005: Örtliche Schwerpunkte der medialen Repräsentation römischer Senatoren. Heimatliche Verwurzelung, Domzil in Rom, Verflechtungen im Reich, in W. Eck/M. Heil (eds), *Senatores populi Romani. Realität und mediale Präsentation einer Führungsschicht. Kolloquium der Prosopographia Imperii Romani vom 11.-13. Juni 2004*, Stuttgart (HABES 40), 53–71.
- Alföldy, G./B. Lörincz, 2003: Die cohors I Batavorum miliaria civium Romanorum pia fidelis im Panonischen Solva (Esztergom), *ZPE* 145, 259–262.
- Alföldy, M.R., 1997: *Germania magna – nicht libera*. Notizen zum römischen Wortgebrauch, *Germania* 75, 45–52.

- Appadurai, A., 1998: Dead certainty. Ethnic violence in the era of globalization, *Development and change* 29, 905-925.
- Barth, F., 1969: *Ethnic groups and boundaries*, Boston.
- Bellen, H., 1981: *Die germanische Leibwache der römischen Kaiser des julisch-claudischen Hauses*, Wiesbaden (Akademie der Wissenschaften und der Literatur, Mainz, Abhandlungen der geistes- und sozialwissenschaftlichen Klasse Jahrgang 1981, Nr. 1).
- Benea, D., 1986: Das Römerlager von Tibiscum und seine Rolle im Verteidigungssystem von Südwest-Dakien, in Ch. Unz (ed.), *Studien zu den Militärgrenzen Roms III. 13. Internationaler Limeskongress, Aalen 1983*, Stuttgart (Forschungen und Berichte zur Vor- und Frühgeschichte in Baden-Württemberg 20), 451-460.
- Bérard, F., 2000: La garnison de Lyon et les *officiales* du gouverneur de Lyonnaise, in G. Alföldy/B. Dobson/W. Eck (eds), *Kaiser, Heer und Gesellschaft in der Römischen Kaiserzeit*, Stuttgart (HABES 31), 279-305.
- Bérard, F., 2001: Remarques sur les gentilices des soldats des légions des Germanie détachés à Lyon dans la première moitié du IIIe siècle, in M. Dondin-Payre/M.-Th. Raepsaet-Charlier (eds), 667-690.
- Bérard, F., 2007 : L'épigraphie lyonnaise, in A.C. Le Mer/C. Chomer (eds), *Carte Archéologique de la Gaule. 69/2. Lyon*, Paris, 163-178.
- Birley, A.R., 2001: The names of the Batavians and Tungrians in the *Tabulae Vindolandenses*, in Th. Grünewald (ed.), *Germania inferior. Besiedlung, Gesellschaft und Wirtschaft an der Grenze der römisch-germanischen Welt*, Berlin/New York (Reallexikon der germanischen Altertumskunde, Ergänzungsband 28), 241-260.
- Bogaers, J.E., 1960/61: Civitas en stad van de Bataven en Canninefaten, *Berichten van de Rijksdienst voor het Oudheidkundig Bodemonderzoek* 10/11, 263-317.
- Bogaers, J.E., 1966: Een Bataaf in Dalmatia, *Numaga* 13, 161-181.
- Bogaers, J.E., 1974: Troupes auxiliaires thraces dans la partie néerlandaise de la Germania inferior, in D.M. Pippidi (ed.), *Actes du IXe Congrès international d'études sur les frontières romaines, Mamaïa, 6-13 septembre 1972*, Bucuresti, 445-463.
- Bogaers, J.E., 1984: Zum Namen des „oppidum Cugernorum“, *Naamkunde* 16, 33-39.
- Boppert, W. 1992: *Militärische Grabdenkmäler aus Mainz und Umgebung*, Mainz/Bonn (CSIR Deutschland II,5).
- Borgolte, M., 2001: Europas Geschichte und Troia. Der Mythos im Mittelalter, in B. Theune-Großkopf et al. (eds), *Troia – Traum und Wirklichkeit*, Stuttgart, 190-203.
- Bowman, A.K./J.D. Thomas, 1994-2003: *The Vindolanda writing-tablets. Tabulae Vindolandenses II-III*, London.
- Boyer, R., 1997: Negotiating *Calidad*. The everyday struggle for status in Mexico, *Historical Archaeology* 31, 64-73.
- Burnand, Y., 2005: *Primores Galliarum. Sénateurs et chevaliers romains originaires de Gaule de la fin de la République au IIIe siècle*, Bruxelles (Coll. Latomus 290).
- Byvanck, A.W., 1935: *Excerpta Romana II. De bronnen der Romeinsche geschiedenis van Nederland: Inscripties*, 's-Gravenhage.
- Byvanck, A.W., 1938: Notes batavo-romaines VI. La pierre tombale d'un Batave au musée d'Aquincum, *Mnemosyne* (3rd ser.) 6, 222-224.
- Carroll, M., 2001: *Romans, Celts and Germans. The German provinces of Rome*, Stroud.
- Carroll, M., 2006: *Spirits of the dead. Roman funerary commemoration in Western Europe*, Oxford.
- Chappell, D.A., 1993: Ethnogenesis and frontiers, *Journal of world history* 4, 267-275.
- Clay, Ch., 2008: Developing the 'Germani' in Roman studies, in C. Fenwick/M. Wiggins/D. Wythe (eds), *TRAC 2007. Proceedings of the Seventeenth Annual Theoretical Roman Archaeological Conference, London 2007*, Oxford, 131-150.
- Crawford, M., 1996: *Roman statutes*, London.
- Deagan, K., 2001: Dynamics of imperial adjustment in Spanish America. Ideology and social integration, in S.E. Alcock/T.N. D'Altroy/K.D. Morrison/C.M. Sinopoli (eds), *Empires. Perspectives from Archaeology and History*, Cambridge, 179-194.

- Derks, T., 1987: *Graffiti uit Velsen*, Amsterdam (unpublished MA thesis University of Amsterdam).
- Derks, T., 1998: *Gods, temples and ritual practices. The transformation of religious ideas and values in Roman Gaul*, Amsterdam (AAS 2).
- Derks, T., 2004: Beelden en zelfbeelden van Bataven: de epigrafische bronnen, in L.J.F. Swinkels (ed.), *De Bataven. Verhalen van een verdwenen volk*, Amsterdam/Nijmegen, 40-69 and 317-319.
- Derks, T./N.Roymans, 2006: Returning auxiliary veterans in the Roman empire: some methodological considerations, *JRA* 19, 121-135.
- Derks, T./J.Van Kerckhove/P. Hoff, 2008: *Nieuw archeologisch onderzoek rond de Grote Kerk van Elst, gemeente Overbetuwe (2002-2003)*, Amsterdam (Zuidnederlandse Archeologische Rapporten 31).
- Dondin-Payre, M., 2001: Secundus et ses dérivés en Narbonnaise, dans les Trois Gaules et les Germanies, in M. Dondin-Payre/M.-Th. Raepsaet-Charlier (eds), 537-597.
- Dondin-Payre, M./M.-Th. Raepsaet-Charlier (eds), 1999: *Cités, municipes, colonies. Les processus de municipalisation en Gaule et en Germanie sous le Haut Empire romain*, Paris.
- Dondin-Payre, M./M.-Th. Raepsaet-Charlier (eds), 2001: *Noms, identités culturelles et romanisation sous le Haut Empire romain*, Paris.
- Doruțiu, E., 1961: Some observations on the military funeral altar of Adamclissi, *Dacia* n.s. 5, 345-363.
- Eck, W., 2004: *Köln in römischer Zeit. Geschichte einer Stadt im Rahmen des Imperium Romanum*, Köln (Geschichte der Stadt Köln 1).
- Eck, W./A. Pangerl, 2004: Neue Diplome für die Heere von Germania Superior und Germania Inferior, *ZPE* 148, 259-268.
- Eriksen, Th. H., 1993: *Ethnicity and nationalism. Anthropological perspectives*, London/East Haven CT.
- Forni, G., 1953: *Il reclutamento delle legioni da Augusto a Diocleziano*, Milano/Roma.
- Forni, G., 1974: Estrazione etnica e sociale dei soldati delle legioni nei primi tre secoli dell'impero, *Aufstieg und Niedergang der Römischen Welt* II.1, 339-391.
- Freis, H., 1967: *Die cohortes urbanae*, Köln (ES 2).
- Galsterer, H., 1990: Von den Eburonen zu den Agrippinensiern. Aspekte der Romanisation am Rhein, *KJVF* 23, 117-126.
- Galsterer, H., 1999: Kolonisation im Rheinland, in M. Dondin-Payre/M.-Th. Raepsaet-Charlier (eds), 251-269.
- Galsterer-Kröll, B., 1972: Untersuchungen zu den Beinamen der Städte im Imperium Romanum, *ES* 9, 44-145.
- Geyer, Ch., 1999: Das "Kleine Hafentor" der Colonia Ulpia Traiana. Ein Rekonstruktionsversuch, in A. Rieche (ed.), *Grabung – Forschung – Präsentation*, Köln/Bonn (Xantener Berichte 8), 61-146.
- Grahame, M., 1998: Material culture and Roman identity. The spatial layout of Pompeian houses and the problem of ethnicity, in R. Laurence/J. Berry (eds), *Cultural identity in the Roman empire*, London/New York, 156-178.
- Gregori, G.L., 1989: *Epigrafia anfiteatrale dell'occidente romano II. Regione Italiae VI-XI*, Roma (Vetera 4).
- Haalebos, J.K., 1977: *Zwammerdam-Nigrum Pullum. Ein Auxiliarkastell am niedergermanischen Limes*, Amsterdam (Cingula 3).
- Haalebos, J.K., 2000: Mosterd na de maaltijd. Een vergeten jubileum: Traianus en het jaar 98 na Chr. in Nijmegen, *Numaga* 2000, 8-41.
- Haensch, R., 1997: *Capita provinciarum. Statthaltersitze und Provinzialverwaltung in der römischen Kaiserzeit*, Mainz (Kölner Forschungen 7).
- Haensch, R., 1999: Die Colonia Claudia Ara Agrippinensium. Ein typischer Statthaltersitz?, *KJ* 32, 641-655.
- Haensch, R., 2001: Inschriften und Bevölkerungsgeschichte Niedergermaniens. Zu den Soldaten der legiones I Minervia und XXX Ulpia Victrix, *KJ* 34, 89-134.

- Heeren, S., 2006: *De nederzetting aan de Passewaaijse Hogeweg*, Amsterdam (Zuidnederlandse Archeologische Rapporten 29).
- Hellenkemper, H., 1972/73: *Delubrum Martis*, *KJVF* 13, 102-106.
- Herz, P., 2002: Sacrifice and sacrificial ceremonies in the Roman army of the imperial period, in A.I. Baumgarten (ed.), *Sacrifice in religious experience*, Leiden etc. (Numen book series 93), 81-100.
- Hodder, I.R., 1982: *Symbols in action. Ethnoarchaeological studies of material culture*, Cambridge.
- Hoffmann, D., 1963: Die spätrömischen Soldatengrabschriften von Concordia, *Museum Helveticum* 20, 22-57.
- Hoffmann, D., 1969: *Das spätrömische Bewegungsheer und die Notitia Dignitatum*, Düsseldorf (ES 7).
- Holder, P.A., 1980: *Studies in the auxilia of the Roman army from Augustus to Trajan*, Oxford (British Archaeological Reports, International Series 70).
- Irmeler, B., 2004: Rekonstruktion einer Porticusordnung an der Rheinseite in Köln, *KJ* 37, 77-102.
- Jones, S., 1997: *The archaeology of ethnicity. Constructing identities in the past and the present*, London/New York.
- Kakoschke, A., 2004: 'Germanen' in der Fremde. Eine Untersuchung zur Mobilität aus den römischen Provinzen *Germania inferior und Germania superior anhand der Inschriften des 1. bis 3. Jahrhunderts n. Chr.*, Mönnssee (Osnabrücker Forschungen zu Altertum und Antike-Rezeption 8).
- Kienast, D., 1996² (1990): *Römische Kaisertabelle. Grundzüge einer römischen Kaiserchronologie*, Darmstadt.
- Kriekhaus, A., 2001: *Roma communis nostra patria est ? Zum Einfluß des römischen Staates auf die Beziehungen zwischen Senatoren und ihren Heimatstädten in der Hohen Kaiserzeit*, in L. de Blois (ed.), *Administration, prosopography and appointment policies in the Roman empire. Proceedings of the first workshop of the international network Impact of empire, Leiden, June 28 – July 1, 2000*, Amsterdam, 230-245.
- Krier, J., 1981: *Die Treverer ausserhalb ihrer Civitas. Mobilität und Aufstieg*, Trier (*Trierer Zeitschrift*, Beiheft 5).
- Lettich, G., 1983: *Le iscrizioni sepolcrali tardoantiche di Concordia*, Trieste (Centro studi storico-religiosi Friuli-Venezia Giulia 11).
- B. Lörincz, B., 2001: *Die römischen Hilfstruppen in Pannonien während der Prinzipatszeit. Die Inschriften*, Wien.
- Loren, D.D., 2005: Creolization in the French and Spanish colonies, in T.R. Pauketat/D.D. Loren (eds), *North American archaeology*, Oxford (Blackwell studies in global archaeology 5), 297-318.
- MacMullen, R., 1982: The epigraphic habit in the Roman empire, *American Journal of Philology* 103, 234-246.
- Mrozek, S., 1973: A propos de la répartition chronologique des inscriptions latines dans le Haut-Empire, *Epigraphica* 35, 113-118.
- Mrozek, S., 1988: A propos de la répartition chronologique des inscriptions latines dans le Haut-Empire, *Epigraphica* 50, 61-64.
- Mrozewicz, L., 1999: Munizipalgesellschaft und römische Ritter. Das Beispiel der Nordprovinzen des Römischen Reiches, in *L'ordre équestre. Histoire d'une aristocratie (IIe siècle av. J.-C. – IIIe siècle ap. J.-C.). Actes du colloque international organisé par Ségolène Demougin, Hubert Devijver et Marie-Thérèse Raepsaet-Charlier (Bruxelles-Leuven, 5-7 octobre 1995)*, Rome (Coll. de l'EFR 257), 31-78.
- Nicolay, J., 2007: *Armed Batavians. Use and significance of weaponry and horse gear from non-military contexts in the Rhine delta (50 BC to AD 450)*, Amsterdam (AAS 11).
- Noelke, P., 1976: Aeneasdarstellungen in der römischen Plastik der Rheinzone, *Germania* 54, 410-439.
- Nouwen, R., 1997: *Tongerren en het land van de Tungri (31 v. Chr. – 284 n. Chr.)*, Leeuwarden (Maaslandse monografieën 59).
- Noy, D., 2000: *Foreigners at Rome. Citizens and strangers*, London.
- Pferdehirt, B., 2004: *Römische Militärdiplome und Entlassungsurkunden in der Sammlung des Römisch-Germanischen Zentralmuseums*, Mainz (Kataloge vor- und frühgeschichtlicher Altertümer 37).

- Raepsaet-Charlier, M.-Th., 1999: Les institutions municipales dans les Germanies sous le Haut Empire: bilan et questions, in M. Dondin-Payre/M.-Th. Raepsaet-Charlier (eds), 271-352,
- Raepsaet-Charlier, M.-Th., 2001: Onomastique et romanisation. Eléments d'une comparaison entre les provinces de Gaule Belgique et de Germanie inférieure, in M. Dondin-Payre/M.-Th. Raepsaet-Charlier (eds), 399-470.
- Reuter, M., 1999: Studien zu den *numeri* des Römischen Heeres in der Mittleren Kaiserzeit, *Berichte der Römisch-Germanischen Kommission* 80, 357-569.
- Ribbens, K., 2004: Van vaderlander tot immigrant. Bataafse beeldvorming in de twintigste eeuw, in L.J.F. Swinkels (ed.), *De Bataven. Verhalen van een verdwenen volk*, Amsterdam/Nijmegen, 236-267.
- Rinaldi Tufi, S., 1971: Stele funerarie con ritratti di età romana nel Museo Archeologico di Spalato. Saggio di una tipologia strutturale, *Atti della Accademia Nazionale dei Lincei CCCLXVIII* (Memorie Classe di Scienze morali, storiche e filologiche VIII, vol. XVI), 87-166.
- Rodseth, L./B.J. Parker, 2005: Introduction. Theoretical considerations in the study of frontiers, in B.J. Parker/L. Rodseth (eds), *Untaming the frontier in anthropology, archaeology, and history*, Tucson, 3-21.
- Roymans, N., 1999: Romeinse frontierpolitiek en de etnogenese van de Bataven, *Bijdragen en mededelingen van de Vereniging Gelre* 90, 15-39.
- Roymans, N., 2004: *Ethnic identity and imperial power. The Batavians in the Early Roman Empire*, Amsterdam (AAS 10).
- Roymans, N./T. Derks (eds), 1994: *De tempel van Empel. Een Herculesheiligtom in het woongebied van de Bataven*, 's-Hertogenbosch.
- Roymans, N./T. Derks/S. Heeren (eds), 2007: *Een Bataafse gemeenschap in de wereld van het Romeinse rijk. Opgravingen te Tiel-Passewaaij*, Utrecht.
- Saller, R.P., 1994: *Patriarchy, property and death in the Roman family*, Cambridge.
- Schalles, H.-J., 1995: Überlegungen zur Planung der Colonia Ulpia Traiana und ihrer öffentlichen Bauten im Spiegel städtischer Architektur des 2. Jahrhunderts n. Chr., *Xantener Berichte* 6, 379-428.
- Scheid, J., 1999: Aspects religieux de la municipalisation. Quelques réflexions générales, in M. Dondin-Payre/M.-Th. Raepsaet-Charlier (eds), 381-423.
- Seiler, S., 1991: Die Ausgrabungen im Kölner Stadtteil St. Alban, *Archäologie in Köln* 1, 46-55.
- Solin, H., 1993: Zur Tragfähigkeit der Onomastik, in W. Eck, *Prosopographie und Sozialgeschichte. Studien zur Methodik und Erkenntnismöglichkeit der kaiserzeitlichen Prosopographie*, *Kolloquium Köln* 24.-26. November 1991, Köln/Wien/Weimar, 1-33.
- Solin, H., 1994/95: Anthroponymie und Epigraphik. Einheimische und fremde Bevölkerung, *Hyperboreus* 1, 93-117.
- Speidel, M.P., 1984: Germani corporis custodes, *Germania* 62, 31-45, reprinted in M.P. Speidel, 1992: *Roman army studies* 2, Stuttgart (Mavors 8), 105-119.
- Speidel, M.P., 1986: The soldiers' homes, in W. Eck/H. Wolff (eds), *Heer und Integrationspolitik. Die römischen Militärdiplome als historische Quelle*, Köln/Wien, 467-481, reprinted in M.P. Speidel, 1992: *Roman army studies* 2, Stuttgart (Mavors 8), 313-327.
- Speidel, M.P., 1991: Swimming the Danube under Hadrian's eyes. A feat of the emperors' Batavi horse guard, *Ancient society* 22, 277-282.
- Speidel, M.P., 1994a: *Die Denkmäler der Kaiserreiter (Equites singulares Augusti)*, Köln/Bonn (BJ, Beiheft 50).
- Speidel, M.P., 1994b: *Riding for Caesar. The Roman emperors' horse guard*, London.
- Stoll, O., 2007: The religions of the army, in P. Erdkamp (ed.), *A companion to the Roman army*, Malden MA, 451-476
- Strobel, K., 1987: Anmerkungen zur Geschichte der Bataverkohorten in der Hohen Kaiserzeit, *ZPE* 70, 271-292.
- Stuart, P./J.E. Bogaers, 2001: *Nehalennia. Römische Steindenkmäler aus der Oosterschelde bei Colijnsplaat*, Leiden (Collections of the National Museum of Antiquities 11 = CSIR Nederland 2).

- Stylow, A.U., 1994 : Ein neues Militärdiplom von 133. Zum personenrechtlichen Status der equites singulares Augusti, *Chiron* 24, 83-94.
- Syme, R., 1938 : Notes sur la légion III^e Augusta, *Revue des Études Anciennes* 38, 182-190.
- Thomas, Y., 1996: 'Origine' et 'commune patrie'. *Étude de droit public romain (89 av.J.-C. – 212 ap.J.-C.)*, Rome (Collection de l'École Française de Rome 221).
- Van Driel-Murray, C., 2005: Imperial soldiers. Recruitment and the formation of Batavian tribal identity, in Z. Visy (ed.), *Limes XIX. Proceedings of the 19th International Congress of Roman Frontier Studies held in Pécs, Pécs*, 435-439.
- Van Rossum, J.A., 2004: The end of the Batavian auxiliaries as 'national' units, in L. de Ligt/E.A. Hemelrijk/H.W. Singor (eds), *Roman rule and civic life, local and regional perspectives. Proceedings of the fourth workshop of the international network Impact of empire, Leiden, June 25-28, 2003*, Amsterdam, 113-131.
- Van Schevichaven, H.D.J., 1881: *Epigraphie der Bataafsche krijgslieden in de Romeinsche legers, gevolgd van een lijst van alle geregelde hulptroupen tijdens het Keizerrijk*, Leiden.
- Vittinghoff, F., 1994: *Civitas Romana. Stadt und politisch-soziale Integration im Imperium Romanum der Kaiserzeit*, Stuttgart.
- Weisgerber, L., 1968: *Die Namen der Ubier*, Köln/Opladen.
- Weisgerber, L., 1972: Zu den rheinischen -inius-Bildungen, in E. Ennen/G. Wiegmann (eds), *Festschrift Mathias Zender. Studien zu Volkskultur, Sprache und Landesgeschichte II*, Bonn, 931-948.
- Wierschowski, L., 2001: *Fremde in Gallien - „Gallier“ in der Fremde. Die epigraphisch bezeugte Mobilität in, von und nach Gallien vom 1. bis 3. Jh. n. Chr. Texte, Übersetzungen, Kommentare*, Stuttgart (Historia Einzelschriften 159).
- Willems, W.J.H., 1984: Romans and Batavians. A regional study in the Dutch eastern river area II, *Berichten van de Rijksdienst voor het Oudheidkundig Bodemonderzoek* 34, 39-331.
- Wollmann, V., 1972: Ein Bataver im römischen Heer in Dakien, *Germania* 50, 247-251.
- Wolters, R., 1990: *Römische Eroberung und Herrschaftsorganisation in Gallien und Germanien. Zur Entstehung und Bedeutung der sogenannten Klientel-Randstaaten*, Bochum.
- Woolf, G., 1996: Monumental writing and the expansion of Roman society in the early empire, *JRS* 86, 22-39.
- Zanker, P., 1988: *The power of images in the age of Augustus. Translated by Alan Shapiro*, Ann Arbor.

Appendix: historically and epigraphically attested Batavi

TABLE A: BATAVI KNOWN FROM HISTORICAL SOURCES

A	name	date	function	army unit	indications for origin	references
1	(C. Iulius) Chariovalda	16	<i>praefectus</i>	<i>ala Batavorum</i> ?	prefecture of Batavian unit	<i>PME</i> I 43; Tac. <i>Ann.</i> 2.11
2	Iulius Civilis	69/70	<i>praefectus</i>	<i>cohors Batavorum</i>	prefecture of Batavian unit	<i>PME</i> I 45
3	Iulius Paulus	70			brother of Civilis	Tac. <i>Hist.</i> 4.13; 4.32
4	Iulius Briganticus	70	<i>praefectus</i>	<i>ala I Flavia singularium</i> <i>PF c.R.</i>	son of Civilis' sister	<i>PME</i> I 35; Tac. <i>Hist.</i> 2.22; 4.70
5	Claudius Victor	70			son of Civilis' sister	Tac. <i>Hist.</i> 4.33
6	(---) Verax	70			son of Civilis' sister	Tac. <i>Hist.</i> 5.20-21
7	Claudius Labeo	70	<i>praefectus</i>	<i>ala Batavorum</i>	prefecture of Batavian unit	<i>PME</i> C 150; Tac. <i>Hist.</i> 4.18

TABLE B: BATAVI KNOWN FROM EPIGRAPHIC SOURCES

B	name	date	function	army unit	indications for origin	findspot	references
1	Valens	14-37	<i>Germanus</i>		<i>nation(e) Batavus</i>	Roma	<i>CIL</i> VI 4341; Bellen A4
2	Linus	41-54	<i>corporis custos</i>		<i>natione Batavus</i>	Roma	<i>CIL</i> VI 8804; Bellen A8
3	Paetinus	41-54	<i>corporis custos</i>		<i>nat(ione) Bata(v)us</i>	Roma	<i>CIL</i> VI 8807; Bellen A9
4	Saturni[nus]	41-54	<i>corporis custos</i>		<i>natione Ba[ta(v)us]</i>	Roma	<i>AE</i> 1968, 32; Bellen A7
5	Imerix Servofredi f.	c. 50	<i>eques</i>	<i>ala Hispano(rum)</i>	<i>Batavos</i>	<i>Burnum</i> / Ivoševci (HR)	<i>AE</i> 1971, 299 = <i>ILJug</i> 843; Bogaers 1966
6	Maloger	c. 50	<i>eques</i>	<i>ala Hisp(anorum) [I]</i>	<i>domo Betav(os)</i>	<i>Aquincum</i> / Buda (H)	<i>CIL</i> III 3577 = 3681 = 10513; <i>RHP</i> 127
7	Ti. Claudius Chlo- reus	54-68	<i>corporis custos</i>		<i>natione Bata(v)us</i>	Roma	<i>CIL</i> VI 8803; Bellen A18
8	Alcimachus	54-68	<i>corporis custos</i>		<i>nat(ione) Bata(v)us</i>	Roma	<i>CIL</i> VI 8802; Bellen A17
9	Nobilis	54-68	<i>corporis custos</i>		<i>nat(ione) Bata(v)us</i>	Roma	<i>CIL</i> VI 8806; Bellen A20
10	Ter[tius]	54-68	<i>corporis custos</i>		<i>nat(ione) Bata(v)us</i>	Roma	<i>AE</i> 1952, 146; Bellen A13
11	Gamo	54-68	<i>corporis custos</i>		<i>nat(ione) Bata(v)us</i>	Roma	<i>AE</i> 1952, 147; Bellen A14
12	Hospes	54-68	<i>corporis custos</i>		<i>frater</i> of Gamo	Roma	<i>AE</i> 1952, 147
13	Indus	54-68	<i>corporis custos</i>		<i>natione Batavus</i>	Roma	<i>AE</i> 1952, 148; Bellen A15
14	Eumenes	54-68	<i>corporis custos</i>		<i>frater</i> of Indus	Roma	<i>AE</i> 1952, 148
15	[---]nus	54-68	<i>corporis custos</i>		<i>nat(ione) Bata(v)us</i>	Roma	<i>AE</i> 1952, 149; Bellen A16

B	name	date	function	army unit	indications for origin	findspot	references
16	Vetus	54-68	<i>corporis custos</i>		<i>n[atione] Ba[ta(vus)]</i>	Roma-Magliana	AE 1983, 58
17	Albanus Balvi f.	c. 70-92	<i>dec(urio)</i>	<i>ala Augusta Ituraeorum</i>	<i>domo Betavos</i>	Brigetio / Szöny (H)	CIL III 4368 = RIU 635
18	Fla(v)us Blandi f.	73-c. 80	<i>eques</i>	<i>ala Front[on]iana</i>	<i>domo Bata[(v)us]</i>	Aquincum / Budapest (H)	AE 1938, 125; Byvanck 1938; RHP 210
19	[---] Gaveri f.	20.2.98	<i>ex gregale</i>	<i>[ala I Ba]tavorum</i>	<i>Bata(vus)</i>	Elst (NL)	AE 1999, 1099 = 2000, 1017; RMD IV, 216
20	[--- Pere]grini filia	20.2.98			<i>Bat(ava)</i>	Elst (NL)	AE 1999, 1099 = 2000, 1017; RMD IV, 216
21	[---]? [---]	98-c. 117	<i>(miles)</i>	<i>coh [---]</i>	<i>[Ulp]ia Novi[omagi B]atavorum</i>	Aquincum / Budapest (H)	RHP 491; Bogaers 1960-61, 281-283, note 122
22	T. Flavius Germ(a)- nus	98-c.125	<i>veter(anus)</i>	<i>leg XXII Pr. PF</i>	<i>natione Bata(v)us</i>	Wiesbaden	CIL XIII 7577; CSIR II.11.5
23	[---]	102/103			<i>Bata(vus)</i>	Adamklissi (RO)	CIL III 14214 (fragm. V l.16) = ILS 9107 = AE 1963, 102
24	[---]	102/103			<i>Bat(avus)</i>	Adamklissi (RO)	CIL III 14214 (fragm. V l.22)
25	M. Ulpius [O ?] ramni f. Inam[nus ?]	102/106- 118	<i>[vet(eranus) ?]</i>	<i>coh I Bat. milliaria c.R. PF</i>	<i>[Bata]vus</i>	Solva / Esztergom (H)	AE 2003, 1373; Alföldy/ Lörincz 2003
26	M. Ulpius (M.f.) Aeb[utianus ?]	102/106- 118	<i>mil(es)</i>	<i>coh I Bat. milliaria c.R. PF</i>	<i>fil(ius)</i>	Solva / Esztergom (H)	AE 2003, 1373; Alföldy/ Lörincz 2003
27	C. Petillius C.f. Vindex	2.7.110	<i>ex decurione</i>	<i>ala Frontoniana</i>	<i>Bata(vus)</i>	Tokod (H)	CIL XVI 164
28	M. Ulpius Peronis f. Fronto	16.12.113	<i>ex pedite</i>	<i>coh I Batavorum milliaria c.R. PF</i>	<i>Bata(vus)</i>	Regensburg	AE 1988, 906; RMD II, 86
29	Mattua Silvani f.	16.12.113			<i>Batava</i>	Regensburg	AE 1988, 906; RMD II, 86
30	Procu[la]	shortly after 118			<i>Batava</i>	Tibiscum / Jupa (RO)	AE 1977, 699 = IDR III.1, 168
31	T. Fl(avius) Rom[a]- nus	98-180	<i>decurio praepositus</i>	<i>ala I Flavia [coh I Breuc?]</i>	<i>Ulpia Noviomagi Bata- (v)us</i>	Pfünz	CIL III 5918 ^a = 11936; Bogaers 1960-61, 278 ff
32	[---]ini fil.	129-134			<i>Bat(ava)</i>	Pappenheim	CIL XVI 105; RMD I, p. 25 and RMD III, p. 245
33	[---]uper	[.].11.135	<i>cui pra(e)est</i>	<i>[coh I Ulpia Brit- tonum] c.R.</i>	<i>Noviomag(o)</i>	Porolissum / Moigrad (RO)	AE 1995, 1283 = 1996, 1275; Haalebos 1999, 200 f.
34	[M]acrinus Regulus	11.8.146	<i>cui pra(e)est</i>	<i>[clas]sis Flav(ia) Pannonic(a)</i>	<i>Neuomag(o) (sic)</i>	unknown	AE 2001, 2156 = RMD V, 401
35	T. Aurelius Probus	after 138	<i>eq(ues) sing. Aug.</i>		<i>nat(ione) Bata(v)us</i>	Roma	CIL VI 3220; ESA 112
36	T. Aur(elius) Scribonius	after 138	<i>eques sing. Aug.</i>		<i>natione Bata(v)us</i>	Roma	CIL VI 3223; ESA 136
37	[Ti. Claudius] S[a]turninus	after 138	<i>hastiliarius equi- tum sing. Aug.</i>		<i>[Ulpia Noviom]agi</i>	Roma	CIL VI 3284; ESA 110; Bogaers 1960-61, 286 f
38	T. Ael(ius) Karus	after 138	<i>v[et(eranus)]</i>	<i>c(o)ho III B[at]- (avorum)</i>	<i>d(omo) Bata(vus)</i>	Vetus Salina / Adony (H)	AE 2003, 1454
39	T. Aurelius T.f. Vindex	138-193	<i>eq(ues) sing. imp. n.</i>		<i>Ulp(ia) Noviomag(i)</i>	Roma	CIL VI 3237; ESA 166; Bogaers 1960-61, 284 ff

B	name	date	function	army unit	indications for origin	findspot	references
40	[T.] Aurelius A[---]	138-193	<i>eq(ues) sing.</i> <i>A]ug.</i>		<i>Ulpia Novioma[gi]</i>	Roma	<i>CIL</i> VI 32843; Bogaers 1960-61, 286 f; <i>ESA</i> 284
41	[---] [Simp]lex	138-193	<i>eq(ues) sing.</i> <i>Aug. [sac(erdos)]</i> <i>Her(culis)?</i>		<i>[nat(ione) Ba]ta(v)us</i> <i>Ulpia [Novioma]gi</i>	Roma	<i>ESA</i> 144
42	[T. Aurelius T.f. ?] [---]	138-193			<i>Batavus</i>	Roma	<i>ESA</i> 710
43	[---]s Avitus	before 193	<i>eq(ues) sing.</i> <i>Aug.</i>		<i>[n(atione) Bat]a(v)us</i>	Roma	<i>ESA</i> 374
44	[---] [Val]erianus	II	<i>eq(ues) sing.</i> <i>Aug.]</i>		<i>[Ulpia Novio]magi</i>	Roma	<i>ESA</i> 181
45	[---] S[---]	II	<i>eq(ues) sing.</i> <i>imp. n.</i>		<i>nat(ione) Bat[a(v)us]</i>	Roma	<i>ESA</i> 277
46	[.] Simplicinius Serenus	II	<i>eq(ues) sing. Aug.</i>		<i>n(atione) Ulp(ia) Novi- omagi Bata(v)us</i>	Roma	<i>CIL</i> VI 32869 ^{bb} <i>AE</i> 1993, 385; <i>ESA</i> 211
47	Victorius Victorinus	II (?)	<i>eques sing. Aug.</i>		<i>[n(atione) Bata(v)us U[l]i pi[a Noviomag]i</i>	Roma	<i>CIL</i> VI 32834 + 32837 ⁱ + 32837 ^a + 32860; <i>ESA</i> 173
48	Vitalis Invicti f.	II	<i>retarius</i>		<i>n(atione) Bata(v)us</i>	Parma (I)	<i>CIL</i> XI 1070; Gregori 1989, no. 46
49	M. Add(ius)? Gar- isianus	II-III			<i>Bata(v)us</i>	Wollseifen (D)	<i>CIL</i> XIII 7833; Van Sche- vichaven 1881, no. 46
50	[---] [---]	II-III	<i>eq(ues) s]ing.</i> <i>[Aug. ?]</i>		<i>[nat(ione) Ba]ta(v)us</i>	Roma	<i>ESA</i> 352
51	[---] [---]	II-III	<i>eq(ues) sing.]</i>		<i>[nat(ione)] Bata(v)us</i>	Roma	<i>CIL</i> VI 32812 ^a ; <i>ESA</i> 442
52	Sanctinius Probinus	after 193	<i>miles</i>	<i>coh IIII pr PV</i>	<i>nat(ione) Bata(v)us</i>	Roma	<i>CIL</i> VI 2548 = <i>ILS</i> 2040
53	Sanctinius Genialis	after 193			<i>frater of Probinus</i>	Roma	<i>CIL</i> VI 2548 = <i>ILS</i> 2040
54	M. Amusan(ius) Hylacus	after 193	<i>miles</i>	<i>coh praetoria</i>	<i>Nov(i)om(agi)</i>	Roma	<i>CIL</i> VI 32627; <i>ER</i> 1331; Bogaers 1960-61, 286 f
55	M. Ingenuinius Super	after 193	<i>miles</i>	<i>coh praetoria</i>	<i>Nov(iomago)</i>	Roma	<i>CIL</i> VI 32627
56	M. Aurelius Aquil- linus	after 193	<i>miles</i>	<i>coh praetoria</i>	<i>Nov(iomago)</i>	Roma	<i>CIL</i> VI 32627
57	Septimius [---]dus	after 193	<i>eq(ues) sing.</i> <i>imp.] n.</i>		<i>n(atione) B(atavus?)</i>	Roma	<i>AE</i> 1983, 56; <i>ESA</i> 589
58	Ulpus Valentinus	after 193	<i>eques sing. imp.</i> <i>nost.</i>		<i>nati(ione) B(atavus?)</i>	Roma	<i>CIL</i> VI 37255 <i>AE</i> 1907, 121; <i>ESA</i> 554
59	Aurelius Victor	after 193	<i>[e]q(ues) s. Augg.</i> <i>[n]n.</i>		<i>n(atione) B(atavus?)</i>	Roma	<i>AE</i> 1924, 117; <i>ESA</i> 555
60	Aurelius Marcellinus	after 193			<i>frater of Victor</i>	Roma	<i>AE</i> 1924, 117
61	Divius Taur[us]	III	<i>eq(ues) sin.]</i>		<i>n(atione) Bad[a(v)us]</i>	Roma	<i>AE</i> 1983, 55; <i>ESA</i> 552
62	Candidinius Verax	III	<i>eq(ues) sin.</i> <i>imp. n.</i>		<i>n(atione) Badaus (sic)</i>	Roma	<i>CIL</i> VI 3240 ^a ; <i>ESA</i> 642

B	name	date	function	army unit	indications for origin	findspot	references
63	Candidinius Spec- tatus	III	<i>equus sing. imp. n.</i>		<i>natione Badaus (sic); frater</i>	Roma	<i>CIL VI 3240^o; ESA 642</i>
64	Superinius Peregrinus	III	<i>[eq(ues)?] castr(a) nova</i>		<i>nat(ione) Ba[tav(u)s]</i>	Roma	<i>CIL VI 3289; ESA 656</i>
65	[---] [R]omana	c. 200-220	(wife of <i>prae- fectus</i>)	<i>[coh III B] atavo[rum (milliaria)] eq.</i>	<i>[Ulpia Nov]iomagi</i>	Púsztaszabolcs (H)	<i>AE 1944, 97 = 1969-70, 526 = RIU 1440; RHP 262; Bogaers 1960-61, 282 ff</i>
66	Celerinius Fidelis	222-235	<i>miles</i>	<i>leg X]XX</i>	<i>civis Batavus</i>	Lyon	<i>CIL XIII 1847 = ILS 2389; Mrozewicz B7</i>
67	Celerinius Augen- dus	222-235	<i>[e(gregius)] vir a mill(itius) (sic)</i>	<i>ala I Pann(oniorum) Seve(riana)</i>	<i>frater of Fidelis</i>	Lyon	<i>CIL XIII 1847 = ILS 2389; PME C 104; Mrozewicz B7</i>
68	T. Fl(avius) Mar- itimus	27.9.244	<i>eq(ues) R(omanus) filius centurionis</i>	<i>leg II Parthica</i>	<i>nat(ione) Bata(v)us</i>	Cnidus (TR)	<i>CIL III 14403 = IK-41, 451</i>
69	(---?) Nero	IIIB			<i>civis Batavus</i>	<i>Reii Apollinares / Riez (F)</i>	<i>AE 1986, 483 = ILN-2, 1.25; Wierschowski 51</i>

TABLE C: EPIGRAPHICALLY ATTESTED MAGISTRATES AND COUNCILLORS OF THE CIVITAS BATAVORUM

C	name	date	function	findspot	references
1	Fla(v)us Vihirmatis f.	IA	<i>summus magistratus civitatis Batavorum</i>	St-Michielsgestel- Ruimel	<i>CIL XIII 8771 = AE 1994, 1281; Bogaers 1960-61, 268-271</i>
2	Val(erius) Silveste[r]	IIB-III A	<i>dec(urio) m(unicipii) Bat(avorum)</i>	Kapel-Avezaath	<i>AE 1958, 38 = 1959, 10 = N-L 256; Bogaers 1960-61, 287-290</i>
3 ^a	Q. Phoeb(ius) Hilarus	227	<i>d(ecurio) m(unicipii) B(atavorum) (negotiator)</i>	Colijnsplaat	<i>AE 1975, 646; 2001, 1488 = Stuart B 37</i>
3 ^a	Q. Phoebi[us] Hi[!]jarus	III A	<i>d(ecurio) m(unicipii) B(atavorum) (negotiator)</i>	Colijnsplaat	<i>AE 1975, 630; 2001, 1499 = Stuart B 63</i>

TABLE D: EPIGRAPHICALLY ATTESTED PERSONAE OF
PROBABLE BATAVIAN DESCENT

D	name	date	function	army unit	indications for origin	findspot	references
1	Iulia Ti[. f.] [---]	c. 50			findspot	Houten (NL)	AE 2001, 1515
2	Hostilius Flavianus	c. 92-97	<i>praef?</i>	<i>coh. VIII Bat</i>	prefecture of Batavian cohort	<i>Vindolanda</i> / Chesterholm	TV 172, 261
3	Vettius Severus	c. 92-97	<i>pr[ae]f?</i>	<i>coh. VIII Bat</i>	prefecture of Batavian cohort	<i>Vindolanda</i> / Chesterholm	PMEV 80 bis; TV 305
4	Flavius Genialis	c. 92-105	<i>praef</i>	<i>coh VIII Bat?</i>	prefecture of Batavian cohort	<i>Vindolanda</i> / Chesterholm	PMEF 49 bis; TV 123- 125, 217-224
5	Flavius Cerialis	c. 97-105	<i>praef</i>	<i>coh. VIII Bat (sc. mil- liaria eq.)</i>	onomastics; prefecture of Batavian cohort	<i>Vindolanda</i> / Chesterholm	PMEF 43 bis; TV 225-290
6	Flavius Similis	c. 97-105		<i>coh. VIII Bat</i>	onomastics; correspondent (and relative of?) Cerialis	<i>Vindolanda</i> / Chesterholm	PMEF 74 bis; TV 254 (cf. also 235, 347)
7	[---] Veranius	c. 97-105	<i>praef</i>	<i>coh. VIII Bat?</i>	prefecture of Batavian cohort	<i>Vindolanda</i> / Chesterholm	PMEV 65a; TV 319
8	Iulius Genialis	96-shortly after 104	<i>veter(anus)</i>	<i>leg X G PF</i>		Empel (NL)	AE 1990, 740; Derks 1998, 112
9	Iulius Adventus	IIA	<i>splorator Bata(v)orum</i>	-	onomastics; <i>Bata(v)orum</i>	Aïn-Témouchent (Algeria)	CIL VIII 21668; Reuter 1999, no. 3
10	[T. Aurelius T.] f. [Ve]rax	138-193	<i>eq(ues) sin[g]. Aug.]</i>		Ulpia [Noviomagi ?]	Roma	CIL VI 32836; ESA 296
11	M. Victorius Pro- vincialis	c. 162-180	<i>praef</i>	<i>coh. IX Bat eq. milli- aria expl(oratorum)</i>		Weissenburg (D)	PMEV 112; CIL III 11918
12	---us Seve[rus, rianus]	IIB	<i>praef</i>	<i>coh III Bat milliaria eq</i>	wife from Ulpia N	<i>Vetus Salina</i> / Adony (H)	AE 1944, 97; AE 1969-70, 526; PME S 54; RHP 262
13	M. Simplicius Simplex	III	<i>praef.</i>	<i>coh I Batavorum</i>	onomastics, prefecture of Batavian cohort	Carrawburgh (GB)	AE 1951, 125 ^c = RIB 1546; PME S 55; Mroze- wicz B15; CSIR I.6.122
14	M. Simplicius Quietus	211-222	<i>trib(unus)</i>	<i>coh III Bat milliaria eq An[[toninian(a)]]</i>	onomastics, prefecture of Batavian cohort, dedication to Vagdavercustis	<i>Vetus Salina</i> / Adony (H)	AE 1935, 163; PME S 54; RHP 264; Mrozewicz B 14
15	Matur[ini]a Pia	222-235			wife of Celerinius Fidelis (B 66)	Lyon	CIL XIII 1847

TABLE E: EPIGRAPHICALLY ATTESTED PERSONAE WITH ETHNIC NOMEN OR COGNOMEN REFERRING TO A RELATIONSHIP WITH THE BATAVI
1-11: monumental inscriptions on stone or bronze; 12-16 instrumentum domesticum

E	name	Date	function	army unit	Indications for origin	findspot	references
1	Batavus	54-68	<i>corporis custos</i>		cognomen	Rome	<i>CIL</i> VI 8802 = Bellen A17
2	Caballus Batavi f.	after 98			filiation	<i>Virunum</i> / Rosendorf	<i>CIL</i> III 4890 = <i>ILLPRON</i> 401
3	M. Ulpius Senecio	after 98			brother of Caballus (E 2)	<i>Virunum</i> / Rosendorf	<i>CIL</i> III 4890 = <i>ILLPRON</i> 401
4	Verecund(ius) Batav(u)s				cognomen	Trier	<i>CIL</i> XIII 3707
5	[---] Batav(u)s	c. 150-160	(soldier)		cognomen	<i>Nigrum Pullum</i> / Zwammerdam	Haalebos 1977, 190, 193 f, no. 10
6	Aur(elius) Batav(us)	after 161	(soldier)	<i>leg XIII Gem?</i>	cognomen	<i>Apulum</i> / Alba Iulia (RO)	<i>AE</i> 1971, 370 = <i>IDR</i> III.5, no. 451; Wollmann 1972
7	Aur(elius) Bata[v(u)s]				cognomen	Rome	<i>CIL</i> VI 19653
8	[F(?)]avia Batava	IIB-III A			cognomen	Cologne	<i>CIL</i> XIII 8339 = <i>RSK</i> 308; Wierschowski 576
9	Batavinia Romana				Rhenish –inius-suffix; wife of legionary from Ger Inf	<i>Avaricum</i> / Bourges	<i>CIL</i> XIII 1196 = <i>AE</i> 1973, 351 = Wierschowski 412
10	Ὀὐαλ(ἔριος) Βαταός	308/310	governor of Caria		cognomen	Bodrum (TR)	<i>AE</i> 1999, 1593b
11	M. Ulpius Batavus	7.1.226	(witness and soldier)	coh praetoria	cognomen		<i>RMD</i> III, 195 ^b = <i>RMD</i> V, 466
12	Batav(u)s	c. 14-c. 54	(soldier)		cognomen	Velsen	<i>AE</i> 1997, 1165a; Derks 1987, no. 5
13	[B]atavus	?	(soldier)		cognomen	Vechten	unpublished, pers.comm. S. Wynia (t), Amstelveen
14	[Ba?][ta(v)]us		<i>mil(es)</i>		cognomen	Valkenburg	unpublished; Haalebos 1977, 190, note 19
15	Batavos	?	(potter)		cognomen	Cologne?	<i>CIL</i> XIII 10001, 67 ^a
16	Batav[i]	?	(potter)		cognomen	<i>Fectio</i> / Vechten	<i>CIL</i> XIII 10001, 67 ^b

Grave goods, ethnicity, and the rhetoric of burial rites in Late Antique Northern Gaul

*Frans Theuvs*¹

- 1 Introduction
- 2 Changing burial rites in Late Antique Northern Gaul: description and explanation
- 3 Ethnic ascription in the archaeology of the Migration period
- 4 Burying groups and rhetorical strategies of representation
- 5 Fourth-century weapon burials in Northern Gaul
- 6 'Weapon graves': material culture and locations
- 7 Conclusion

References

I INTRODUCTION

One of the attractions of the archaeology of Late Antiquity and the Early Middle Ages is the fact that burial rites involving the deposition of objects and food in graves were a common phenomenon in many regions of Europe.² In addition, the inhumation burial, which gained popularity in the Roman West at the end of the 2nd century, involved the interment of the dressed body.³ As far as soil conditions permit, remains of the skeleton, textiles, clothing accessories, food, pottery, weapons and jewellery have been preserved. It is on the basis of this material culture and skeleton remains that we are able to construct – or reconstruct – the successive acts of the burial rite. Only a small part of the total ritual – the deposition of the body and

¹ The basic ideas in this article were formulated in a paper given at the Leeds International Medieval Congress in July 1997 in a co-performance with Prof. Dr. Guy Halsall then of Birbeck College, University of London. Later the paper was presented in a session of the working group, led by Dr. Walter Pohl (Austrian Academy of Sciences) of the 'Transformation of the Roman World' programme of the European Science Foundation at the University of California in Los Angeles, as well as for staff and students of the department of archaeology of the University of Paris 1 Sorbonne Pantheon on the invitation of Prof. Sander van der Leeuw (Paris 1) and Dr. Anick Coudart (Centre National des Recherches Scientifiques). I would like to thank them all for their kind invitations and for

the discussion following the presentations. My special thanks go to Prof. Dr. Guy Halsall and Prof. Dr. Bonnie Effros (now Binghamton University, New York) for their lively revisionist discussions on late Roman and early medieval burial rites. They have asked me impatiently where I buried my paper. Guy Halsall has already published his views on the subject matter in Halsall 2000, while Bonnie Effros' ideas have been published in Effros 2003. The ethnicity symposium at the VU University Amsterdam, organised by Dr. Ton Derks and Prof. Nico Roymans in December 2001, was a welcome opportunity to address the topic again. I would also like to thank them for their invitation and comments. The manuscript for this paper was written in 2001, and finished in 2003.

objects in the grave, and hopefully earlier and later activities around the grave – can be archaeologically reconstructed.⁴ Interpreting the meaning of the ritual acts is therefore a hazardous undertaking, although it is precisely such an interpretation that archaeology should aim at. The interpretation of burial rites in late Roman and early medieval times has a long intellectual history that merits a study of its own.⁵ On the continent at least (in France, the Low Countries and Germany), much of it appears to stand on firm ground, rooted in the intellectual traditions that have developed since the late 19th century. However, recent research, both of an empirical and theoretical nature, has exposed the patches of drift sand in the familiar interpretative schemes.⁶ Answering simple questions about the relationship between burial communities – defined as groups burying their dead at a single cemetery – and actual social groups, such as families or co-resident groups, is no easy matter. Nor do we understand the complementarity of different cemeteries and the significance of the choices families had between different burial grounds in terms of defining different social solidarities.⁷ Whereas the vertical social hierarchy between individuals and family groups has traditionally been regarded as the chief determinant of differences in the wealth of grave goods, recent research points to the importance of sex and age for determining the composition of this set.⁸ We understand little about the meaning of typological groups of objects in relation to social networks.⁹ Are these groupings of objects, made primarily for the purpose of chronological ordering, relevant to the study of social and ideological problems? There are many questions we could raise about traditional and current interpretations of late Roman and early medieval burial rites in the west. One key element, one which lies at the root of almost all traditional interpretation, is the construct of the homogeneous society.¹⁰ This homogeneity creates dichotomies such as ‘Romans’ versus ‘Germans’, ‘Franks’ versus ‘Burgundians’, ‘Christians’ versus ‘pagans’, etc.¹¹ These binary constructs have seduced archaeologists into making associations between these categories and ritual acts or groups of objects to form an almost ‘natural’ overlap between material culture and ethnic identities. However, in the light of recent empirical and theoretical research¹², these binary schemes oversimplify the complexities of changing ritual repertoires in changing societies.¹³ And that is exactly what late Roman Northern Gaul was: a society under transformation in which contemporaries developed new

² I use the term ‘grave goods’ in a very general sense to indicate all the finds in a grave, irrespective of whether they are clothing accessories, objects carried on the body or objects placed in the grave. For a short introduction to the burial ritual in late Roman and early medieval times in the west, see Halsall 1995. Böhme 1974 remains the starting point for the study of the burial ritual in the 4th and 5th centuries in Northern Gaul. The historiography and development of intellectual engagement with and interpretation of this material is well presented in Effros 2003. To date, an immense body of literature has been produced, including publications on individual cemeteries, regional surveys, and surveys for specific types of objects, graves etc.

³ Young 1977, 43–45.

⁴ To gain some insight into the complexities of Roman and early medieval/Christian burial rituals, see for instance: Schoen 2000 and Paxton 1990.

⁵ See Effros 2003.

⁶ Samson 1987; Halsall 1992; Halsall 2000; Härke 1990; Härke 1992; Härke 2000; Theuvs/Alkemade 2000.

⁷ Theuvs 1999. High-ranking families were already confronted with this choice from early in the 6th century on. For the majority of the population, this choice did not become relevant until the 7th century, when we observe the dissolution of traditional cemeteries in many small individual burial grounds in several regions of north-western Europe. See for instance the case of southern Germany: Scholkmann 1997 and Theune-Grosskopf 1997. Similar developments are evident in France.

⁸ Halsall 1995, 61–73, 79–86, 109, 162–163; Halsall 1996.

⁹ See Theuvs/Alkemade 2000 and Theuvs 2001.

¹⁰ Theuvs 2000.

¹¹ There is by now a growing quantity of critical literature on this subject that relates closely to the ethnic identity debate. For recent positions in this matter, see Pohl/Reimitz 1998; Pohl 2000; Gillet 2002; Geary 2002.

¹² Barth 1992; Treherne 1995.

¹³ Theuvs 2000.

ritual repertoires to create and give meaning to new identities. It is in this light that I will attempt to tackle one construct: the relationship between specific burial rites and ethnic identities as revealed in written texts. I will try to show that ethnic identity was not at issue in the burial ritual, but rather new identities of another kind.¹⁴ In order to do so, I must first explain some major changes in the ritual repertoires relating to burials, elements of the ethnic identity debate concerning Late Antique Northern Gaul, an alternative interpretation scheme and alternative interpretations for one specific burial rite: the deposition of 'weapons' in graves in 4th-century Gaul.¹⁵

2 CHANGING BURIAL RITES IN LATE ANTIQUE NORTHERN GAUL: DESCRIPTION AND EXPLANATION

It was customary in the Roman west to cremate the dead.¹⁶ The remains of the deceased were interred in a wide variety of ways. The cremation grave could be simple: a small hole in the ground where the burned bones, taken from the cremation pyre, were buried in a cloth, together with a few containers of food and drinks. There was some variation in the treatment of pyre remains or the addition of grave goods. The grave could be more elaborate and monumental: some graves have large mounds or stone monuments erected over them.¹⁷ In Northern Gaul, this basic pattern underwent a number of changes from the late 2nd century onwards.

Firstly, in the late 2nd and early 3rd century, inhumation was introduced in the cemeteries of towns such as Cologne and Tongres.¹⁸ Both cremation and inhumation were practised in the 3rd century, and from the end of the 3rd century, inhumation dominated the burial rites in both town and countryside. The practice of depositing food and drinks was maintained, however, so that large quantities of pottery and to some extent glass vessels have been recovered from graves from the first half of the 4th century. Cremation almost disappeared, but not altogether. It should be stressed that the cremation ritual was still practised up until the first half of the 5th century and, on a smaller scale, even later.¹⁹

¹⁴ As Halsall has done in 1992 and 2000, and Effros in 2003, although my conclusions and interpretations differ in several respects from theirs. See also Theuvs/Alkemade 2000, 456–461, with preliminary critical comments on late Roman (4th-century) weapon burials. Some modifications on the positions adopted are presented here.

¹⁵ This article is part of my ongoing preoccupation with existing interpretations of late Roman and early medieval burial rites and my wish to provide alternative interpretations. See also Theuvs 1999, 2000, Theuvs/Alkemade 2000.

¹⁶ Toynbee 1996² (1971).

¹⁷ Plumier 1986; Panhuysen 1996, 121–190.

¹⁸ Vanvinckenroye 1984; Friedhoff 1991; Pöfgen 1992, I, 112–123, with a discussion of the different explanations offered for the rise of inhumation graves in a Roman context. See also Riedel 1998.

¹⁹ Dasnoy 1988, Lemant 1985, concerning Vireux-Molhain. In contrast to Halsall (2000, note 68), I think that there are sound indications for the presence of crema-

tion graves in the cemetery of Vireux-Molhain. Seiller 1992, 601, concerning Vron, where nine late Roman cremations have been found. The still unpublished late Roman cemetery of Gennep-Touwslagersgroes (late 4th/early 5th century) consists entirely of cremation graves. A transition to inhumation seems to have taken place somewhere in the third quarter of the 5th century. The burnt objects found in the cremation graves are of the same type and quality as those of the inhumations of the Namurois. Many more cemeteries in Northern Gaul contain cremation graves, such as the cemetery found under Saint Severin's in Cologne, where a cremation grave (number I, 69) with an axe was found, dating to the first half of the 3rd century, making it a chronologically isolated early find of a weapon grave (Pöfgen 1992, II, 60–62). In the course of the 7th century, the cremation ritual regained popularity once again in the Rhine delta (Van Es 1968, 15–16; Ypey 1973; Van Es/Wagner 2000).

of women.²² The weapons were mainly axes, lances, bows and arrows (fig. 1). The best-known jewellery found in women's graves are the spectacular *tutulus fibulae*, together with several other types of brooches and hairpins.

Fourthly, from the late 4th century on, a more diverse set of weapons began to be deposited in men's graves. We encounter swords and shields too, although the number of graves with such weapon sets is extremely small in comparison to the total number of graves found.²³ I believe it is vital that we distinguish between the period before the very late 4th century (c. 390), when weapon graves contained almost exclusively axes, lances and bows and arrows, and the period thereafter, when *some* lavish burials with swords and shields appeared as well.²⁴ These burials are of a very diverse nature and, as with the rare sword burials from the late 3rd and 4th century, we can question whether they point to a structural change in burial rites. Weapon graves containing axes, lances and bow and arrows still predominated in this second phase. Sword burials (with the so-called Krefeld scabbards) did not appear until the middle of the 5th century. Because of their shared characteristics, this may point to a structural change in burial rites after the introduction of weapon graves around the middle of the 4th century.²⁵ This last phase, which continued until the beginning of the 6th century, was phase 3 in the development of late Roman burial rites in Northern Gaul.

Fifthly, in the late 4th century, new cemeteries appeared in new places such as on or near hilltops close to a fortress, although we cannot link all new cemeteries to such fortresses. Examples are Furfooz, Samson and Vireux-Molhain in the Ardennes, Rhenen in the north and Vron on the Channel coast.²⁶

These last three changes in burial rites have been interpreted in terms of the ethnic identity of the deceased. Graves with weapons, belts and brooches are usually ascribed to Germanic warriors in the service of the Roman army.²⁷ Originally, weapon graves were believed to be those of *laeti*,²⁸ but Böhner and Böhme suggested that they belonged to *foederati*, an interpretation that has been widely accepted.²⁹ One argument for interpreting these graves as those of Germanic warriors is that it was not generally deemed appropriate for Roman civilians to carry weapons, in life or in death. Some of the material, especially the women's brooches, is believed to have originated from the Germanic territories east of the Rhine.³⁰ The appearance

²² Böhme 1974; Böhme 1985; Swift 2000. We know of isolated examples of graves with an axe dating from the 3rd century. See above note 19 and Pirling 1993.

²³ An occasional sword or shield dating to before the very end of the 4th century has been found in Northern Gaul. See Schulze-Dörlamm 1985, Abb. 32 and 33. For an early shield in Krefeld Gellep, see Pirling 1993. However, these few instances (between 5 and 10 for the entire late 3rd to late 4th century) must be seen as incidents triggered off by special circumstances of death rather than a structural change in burial rites in Northern Gaul.

²⁴ Theuws/Alkemade 2000, 450, where we distinguished three major phases in the development of late Roman burial rites in relation to weapon graves: almost the entire 4th century (maybe the first half of the 4th century should be considered a phase of its own), late 4th/first half of 5th century, second half of 5th century/beginning of 6th century. It therefore confuses the issue to talk about the Germanic federate's graves of the 4th and 5th centuries. Something occurred in the late 4th century

that distinguishes the following period from the previous one. However, this change did not affect all rites; the lavish sword burials were added to an existing repertoire.

²⁵ Theuws/Alkemade 2000.

²⁶ Furfooz: Brulet 1990; Samson: Dasnoy 1968; Vireux-Molhain: Lemant *et al.*, 1985; Rhenen: Ypey 1973, Van Es/Wagner 2000.

²⁷ Böhme 1974, 190: 'Neu angekommene Germanen, die erstmals mit den Römern in engeren Kontakt kamen und sich ihres Kriegertums und ihrer gehobenen Stellung in Gallien bewusst wurden, scheinen die Sitte der Waffenbeigabe ausgebildet zu haben.' See also Böhme 1985; Böhme 1996; Seiller 1992 and many others. For an historiographical overview, see Effros 2003 and Halsall 1992 and 2000.

²⁸ Werner 1950.

²⁹ Böhner, 1963; Böhme 1974, 195–207.

³⁰ See, however, comments to the contrary in Halsall 1992 and 2000.

of new burial rites and new types of objects, for both men and women, has been linked to the settlement of Germanic newcomers in Northern Gaul.³¹ These arguments follow directly from the concept of homogeneity, according to which each group has distinct characteristics that all its individual members must share. Such a model allows no room for reflection by individuals and groups, based on their observations and the appropriation of different cultural models, which would result in new interpretations and subsequently in new ritual repertoires. In the model proposed by Böhme and others, the ‘mixed culture’ of late Roman Northern Gaul is one in which two distinct groups co-existed, but indeed as two distinct homogeneous cultural groups. The mixed culture is explained as the intermingling of ethnic groups, but not as a merging of ideas and mentalities based on reflection and interpretation in a new situation. There are two types of elite, two types of peasants, two types of women, two types of dwelling (stone and wood), etc.

This explanation of the presence of ‘Germanic’ men’s graves/weapon graves and women’s graves has met with criticism. While some scholars offered alternative ethnic interpretations, others were fundamentally critical about the ethnic interpretation of the burial ritual itself.³² Speaking of ‘Germanic’ weapon burials from the 5th rather than the 4th century, Périn emphasises – correctly – that the custom of depositing weapons in graves at that time emerged in Northern Gaul. He does not ignore the fact that Germanic influences played a role, but prefers to qualify the men in the graves as ‘Gallo-Frankish’ rather than as ‘Germanic warriors’.³³ However, he does not voice similar doubts about the ‘Germanic’ character of the weapon burials of the 4th century.³⁴ Although he is critical about the interpretations of weapon graves as those of Germanic warriors, his alternative falls within the classic, ethnic interpretation of the burial rites. I will explore the alternative explanations of Halsall and Whittaker in more depth in order to explain where my interpretations differ from theirs.

Halsall questioned the Germanic origin of the 4th-century weapon burial rite by showing that important elements of the rite had no antecedents in the Germanic territories east of the Rhine.³⁵ He claims that the supposed origin of specific objects east of the Rhine is also open to question. A point in case are the *tutulus fibulae*, considered a clear marker of Germanic identity for the women in whose graves they are found. Although the style of these *fibulae* may have been inspired by Germanic examples, Halsall claims that several forms may have been produced in Northern Gaul, by Romans for Romans, and not by Romans for Germanic women, whose tastes differed from their Roman counterparts.³⁶ Most other finds in Germanic women’s graves are interpreted as being of Roman origin. Next, Halsall points to the

³¹ For a recent interpretative example, see Van Es and Wagner (2000, 126), who suggest that the men and women buried with weapons and jewellery in the western part of the cemetery at Rhenen were members of leading indigenous Germanic families. They do so because the cemetery is situated on the north bank of the Rhine and thus ‘officially’ in Germanic territory. That the deceased were members of indigenous families is based on flimsy archaeological material that is supposed to indicate continuity of habitation from as early as the Iron Age onward (this argument may relate to a desire to present a lengthy continuity in ‘Germanicness’ of the indigenous people north of the Rhine, a central theme in the traditional early medieval ethnic identity debate: see the various contributions in Gillet 2002 and Bazelmans, this volume). Van Es and Wagner suppose that the indigenous men and women had intensive contacts with the

Roman world and functioned as middle men between Roman and Germanic groups. The men also served in the Roman army and for that reason practised a ‘Roman’ burial ritual (inhumation). However, we cannot rule out the possibility that those buried there were outsiders who settled in the Rhenen area and whose origins we cannot establish. As will be explained below, neither the Germanic identity of the settlers nor their native background can be substantiated.

³² Young 1980; Périn 1981a and 1981b; Halsall 1992 and 2000; Whittaker 1994; Effros 2003.

³³ Périn 1981a; Périn 1981b; Périn/Feffer 2001³, 119–142.

³⁴ Périn/Feffer 2001³, 69–80.

³⁵ Halsall 1992.

³⁶ Distribution maps of *tutulus fibulae* show that different forms were deposited in graves in Northern Gaul and in Northern Germany. See Halsall 1992 and 2000.

uneven distribution of Germanic men's and women's graves. Large areas, notably the Trier-Moselle and Metz regions, contain no Germanic women's graves.³⁷ As we will see later, not only is this discrepancy relevant, but also the uneven distribution in Northern Gaul of men's graves containing weapons. They are relatively rare in the Moselle valley and its surroundings. Germanic jewellery is also sparse in the Meuse valley and adjacent regions.³⁸ Halsall interpreted men's graves containing elaborate belts and weapons as being those of local leaders who, in the absence of effective Roman control, competed for the leadership of their communities. He claims that the burial rite was intended 'to make statements of local prestige which, turning the usual interpretation on its head, might have been used by 'Germanic' settlers, but was fundamentally late 'Roman'. Looking at the symbols displayed I then argued that these burials claimed forms of power normally reserved to the empire and its officials (the belt sets and official brooches; the weaponry)'.³⁹ This interpretation proceeds from his suggestion that 'furnished burial is a symptom of social instability and especially of power passed only with difficulty from one generation to the next. Put briefly the burial of grave-goods is a transient ritual display, requiring an audience at the graveside to read and understand the symbolic message of the artefacts. Analysis of the rite, in its various manifestations, in Gaul between the late 4th century and the late 7th suggests that it was adopted by local elites as a response to political crises and threats to their power, or, more widely as a competitive rite within larger communities.'⁴⁰ It is my contention that this model is a step in the right direction, although it is too strictly geared to social practices, political events and power crises.⁴¹ Halsall, in his attempt to demonstrate that these graves cannot be interpreted as 'Germanic', goes to great lengths to show that the rites were all Roman. In doing so, I fear he loses sight of the significance of the novelty of weapon burial rites in the 4th century. The introduction of these new rites also requires some explanation. Why was a new ritual introduced when local leaders under pressure could have elaborated on existing ones?⁴² I will explain below that new ritual repertoires have meanings beyond social practices and the exercise of power, that they are highly relevant in the creation, definition and interpretation of new concepts, values, norms and ideas, and that the late Roman weapon burial rite was not initially about local leadership.

Whittaker's explanation follows a similar route to that of Halsall in that it is social rather than ethnic.⁴³ He concludes that the weapon graves had 'Germanic' connections, but that many of them were well integrated into Roman provincial culture. He finds it difficult to distinguish a cultural separation between Germans and Romans. He suggests, following Böhme, that weapon graves were possibly associated with Germanic families (because women's and children's graves are found alongside weapon graves of men) who took over villas. At the same time, military leaders became increasingly attached to the soil under a system of increasing military patronage, the more so after the imperial court moved to the border provinces. Landlords turned into warlords, with their own small, armed groups to protect themselves and their property. Whittaker explicitly refers to Vireux-Molhain as an example of military rural patronage, although he designates it a 'small Roman fort opposite a *vicus*, reinforced in the mid-4th century to mid-5th century by Germanic-looking groups'.⁴⁴ Again, this is an interesting perspective that attempts to move

³⁷ See the map in Halsall 1992.

³⁸ Böhme 1985, 76.

³⁹ Halsall 2000, 170. He is referring to his 1992 article in which he hypothesised that the 'Germanic' graves could be related to the '*Bacaudae*' mentioned in the written sources and interpreted by Van Dam as 'local community leaders who asserted their power as and when the imperial authority could not make itself felt in their region' (Halsall 1992, 205-206, referring to Van Dam 1985).

⁴⁰ Halsall 2001, 121-122.

⁴¹ See below.

⁴² I am not convinced by his interpretation of axes as related to *limitanei*, Roman weapon burials in the Vosges, and depositions of weapons in cult places and in water (Halsall 2000). In my opinion, rather than an elaboration of existing rites, the weapon burial rite is a new phenomenon.

⁴³ Whittaker 1994, 233-278.

⁴⁴ Whittaker 1994, 270.

away from the old dichotomies. Nevertheless, he has difficulty letting go of the label ‘Germanic’ warrior to describe the occupants of the weapon graves. At best they have become ‘Germanic-looking’.

By now the ‘archaeological ethnic ascription theory’, which presupposes a clear relationship between specific types of objects and a person’s ethnic identity, has been amended to such an extent that we can no longer apply it with confidence. Recent research on the ascription of battle axes (*francescas*) to Franks as a sign of their ethnic identity has revealed the modern origin of the concept rather than its relationship to the early medieval practice of depositing axes in graves in the 4th to 7th century.⁴⁵ The ethnic ascription theory has also been criticised by Amory, among others, in relation to Gothic identity, and more recently by Brather with regard to Alamannic, and by Effros with regard to Germanic identity.⁴⁶ Nevertheless, ethnic ascription is still widely practised, as revealed in the publications of German, French and Dutch scholars.⁴⁷ However, now that we appreciate that the new burial rites cannot easily be associated with Germanic ethnic identity, we are left with the question as to what they do signify. Before attempting to answer the question, I would first like to outline the ethnic ascription theory in Migration-period archaeology in order to understand how it evolved and just where it went wrong.

3 ETHNIC ASCRIPTION IN THE ARCHAEOLOGY OF THE MIGRATION PERIOD

Until now, our understanding of late Roman burial rites in Northern Gaul has fallen within the classical ethnic ascription theory. It is not enough to formulate alternatives to this theory; instead, we must explain where it falls short. Central to the ethnic ascription theory in Migration-period archaeology is the merging of typological groups (my element 6 below) and distribution patterns (my element 7) with the constructions of homogeneous totalities represented by historians as tribal groups on the basis of ‘at face value’ interpretations of written texts (my element 3). I will explain this in more detail below while identifying the different elements of the theory and the problems with each one.

Any discussion of ethnic identity in late Roman and early medieval times proceeds on the basis of contemporary or later texts that present ethnic identity – an identity for large, overarching socio-political formations at an abstract level⁴⁸ – as a fundamental aspect of society. This *textual construction* of identity is the first element. In general, the texts – from quite different genres and intended for a variety of audiences – were written within the Greek and Roman ethnographic traditions, with their stereotypical

⁴⁵ Pohl 1998, 32–37.

⁴⁶ Amory 1997; Brather 2002. However, I cannot agree with Brather’s pessimism on the interpretative possibilities of archaeology beyond everyday life, long-distance exchange, economics and social differences. See also Effros 2003.

⁴⁷ See Koch’s unconditional identification of bow-brooches as markers of Germanic ethnic identity and specific types of these brooches as those of Frankish, Alamannic etc. women (1998, 535–564). This type of archaeological reasoning (‘Merowingerzeitliche Bügelfibeln sind hervorragend dazu geeignet, Frauen fränkischer Herkunft von solchen andersgermanischer Provenienz zu unter-

scheiden’) seems to be a thing of the past, although I do admire the work for its catalogues and distribution maps, bearing in mind Härke’s criticism of the way these are composed (Härke 1991). Other examples are Böhme 1985, Seiller 1992 (with interesting circular arguments to match the archaeological data to the historical evidence), and Van Es/Wagner 2000.

⁴⁸ ‘Ethnic identity’ or identities at the level of smaller polities, as we know them from earlier Roman times (see the contributions by Derks and Roymans, this volume), seem to be rarely mentioned in the written sources and epigraphy of the late Roman period (4th/5th centuries).

qualifications of the ‘barbaric other’.⁴⁹ Modern historiography has ceased to take these texts at face value as reliable ethnographic treatises on other population groups. Instead, such narrative texts are constructions in written form of a perceived reality serving specific goals. It is vital to analyse who wrote the text, in what context, and for what perceived audience.⁵⁰ Because many authors in late Antiquity and the Early Middle Ages wrote texts with a specific agenda in mind, we cannot extract single phrases from texts in order to analyse ethnic identities or even to simply illustrate these identities. However, this does force us to ask what the relationship was between these texts and contemporary socio-political practices.⁵¹

The second element is precisely those practices. How can we know about past political practices? A fundamental question is the relationship between (a) the act of producing the texts in relation to contemporary socio-political practices and (b) the contents of the texts in relation to such practices. The problem, however, is that these practices have to some extent been constructed – or reconstructed – on the basis of the same texts. So the question has to be rephrased: is it possible for us to know about socio-political practices independent of their past representations, or are we essentially analysing these past representations?⁵²

The third element comprises older (19th and first half of the 20th century) interpretations in historiography. Texts were often taken at face value and descriptions of the ‘other’ were considered ‘true’ descriptions of the cultural differences at the time the text was produced or of the period and region under consideration. Such interpretations flourished in the 19th century in the context of new emerging nation states in Europe and the nationalism that accompanied this.⁵³ Moreover, they were based on a concept of culture that took cultural homogeneity as its point of departure. Ethnic groups described in the ancient texts were thus considered forerunners of the new unified nation states. Because ancient ethnographic traditions were shaped in part by similar theoretical and ideological elements, it was easy to make such interpretations.⁵⁴ This created a ‘natural’ overlap between modern interpretations and old texts, so that there was no need to question the new 19th- and early 20th-century interpretations.

The fourth element in the debate is the late 20th-century interpretations of the texts. These developed after scholars accepted that the texts were largely literary constructs that *may* have related to cultural practices, observable differences and social practices, but equally, may not. They realised that a lack of independent sources made it difficult to establish whether the description of cultural differences in the texts referred to cultural differences that could have been observed ‘in the field’. Anthropological insights, in particular Frederic Barth’s *Ethnic groups and boundaries*, began to inform the debate.⁵⁵ Scholars became aware that ‘ethnographic rules’ of an iron-like rigidity, to which almost all individual members of a group had to adhere from a young age, did not exist.⁵⁶ The 19th-century construct of overlapping cultural and biological identity had already been abandoned.⁵⁷ It was now suggested that there was some degree of overlap between ethnic and social identity, especially at the upper echelons of society. To be a Franc, for

⁴⁹ See the various contributions on the nature of the textual construction of identity and its value for the historiography of ethnic identities in Murray 1998; Pohl 2000; Gillet 2002.

⁵⁰ Goffart 1988; Bazelmans 1999, 69–110.

⁵¹ Pohl 2002.

⁵² Ian Wood (1997) already pointed out this problem when he insisted on the need for a history of representations in late Antiquity and the Early Middle Ages.

⁵³ Effros 2003.

⁵⁴ Maas 1992, and as explained by Michael Maas in a paper

at the University of California during a session of The Transformation of the Roman World programme.

⁵⁵ Barth 1969.

⁵⁶ This is of course the central rule governing the ethnic ascription theory in archaeology. If you are born a Frankish girl, you wear a brooch of a certain type until you die (this begs a host of questions: who determines who is a Frankish woman, from what age, at what age can a woman choose her own Frankish identity etc.?).

⁵⁷ Reynolds 1998, Effros 2003 and many others.

instance, was to be a leader in society.⁵⁸ Emphasis now lay on the fluidity of ethnic rules; Patrick Geary, in a well-known article, described ethnicity as a ‘situational construct’.⁵⁹ Also entering into the debate were the relations and tensions between collective representations (by whom?) and individual attitudes.⁶⁰ The ethnic identity debate thus became highly complex, with clarity only emerging when another issue came to the fore: the distinction between the observations of cultural differences on the one hand and representations of cultural differences as political action on the other hand – in other words, the true realisation that elements one and two were not identical. As Walter Pohl states, the discourse on otherness – the ethnic discourse – became a key to political power in Late Antique and early medieval Europe.⁶¹ He claims that ethnic identity owes its relevance to European history to the fact that it became one of the key political factors in early medieval polities.⁶² This should not suggest that from then on everyone could be easily identified as belonging to a specific ethnic group simply by the way they walked about. As stated above, the texts that played a seminal role in this political process may not accurately describe observable cultural differences. Textual rhetoric and social practices may differ.

A fifth element in the debate is the material construction of identity. Written and spoken language is not the only medium for constructing identities; others are gestures and material culture. The way that people dress in specific situations, that pots are shaped, food is eaten, houses are built, settlements are organised and landscape is shaped may convey messages about the identity – including the ethnic identity – of a person, a family, or a group. However, the symbolism is complex and, by definition, open to multiple interpretations, in both the past and the present. Trying to understand the rhetoric of material culture in relation to the creation of identities is a hazardous undertaking. Nevertheless, it is one which archaeologists have been attempting for a long time.⁶³

The sixth element in the debate is the creation of typologies of objects. This was the first technique employed by most archaeologists of the Migration period to organise the material in an attempt to understand material constructions of identities. Based on the assumption that certain elements of clothing and jewellery were markers of specific ethnic identities, archaeologists devised detailed typologies to distinguish various ethnic signs.⁶⁴ However, typologies are modern constructions based on morphological characteristics of objects. Although very useful for categorising objects chronologically, they may be less so when it comes to analysing social structures, identities or ideas.⁶⁵ This classification of objects into typological groups that are then often equated with social and/or cultural groups is based on the materiality of the object alone. Although materiality as a major characteristic and value⁶⁶ of an object may be a familiar concept to us, it may not be the only relevant value in a Migration period context for many of the objects involved. An object’s value or worth will not have been determined at the moment of production alone:⁶⁷ it will have developed while circulating and ageing, to produce a ‘cultural biography’.⁶⁸ Objects might have been valued for their ‘worth’ rather than their form, yet it is the latter characteristic which determines how they are grouped in a typology. In that case, objects that differ in a typological sense could well be identical in the perception of contemporaries on the basis of their worth. For exam-

⁵⁸ This was certainly the case in later times. For instance in the *Annales Regni Francorum*, the *Franci* were the leading men of Neustria (Gerberding 1987).

⁵⁹ Geary 1983.

⁶⁰ Amory 1997.

⁶¹ Pohl 1998, 2.

⁶² Pohl 1998, 5.

⁶³ For instance, on the basis of sunken huts = Germanic, certain pot-types = Germanic etc. See Effros 2003.

⁶⁴ See above note 47.

⁶⁵ Theuvs/Alkemade 2000, 469–470; Theuvs 2001, 198–199.

⁶⁶ I use the term ‘worth’ to designate the immaterial ‘worth’ of the object and ‘value’ for its material ‘value’, although this is a somewhat modern distinction which may not have been so clear-cut in late antiquity. See also Bazelmans 1999, 168–188.

⁶⁷ As the sum of the costs of labour, material and capital.

⁶⁸ Kopytoff 1986.

ple, swords distributed by a single king, which should therefore be considered as a coherent group and which were probably recognised as such in the Early Middle Ages, may be found in different groups of the modern typologies because of their different shapes and forms.⁶⁹ These different typological groups are generally associated with tribal groups such as Franks and Alamanni. In other words, while typologies of objects might be a useful tool for organising material for a chronological classification of objects, they do not provide a useful classification for analysing identities.

The seventh element in the debate is the creation of distribution maps of objects regarded as ethnic markers. Such maps represent the distribution of objects in each group of the typology. This distribution is then interpreted as a distribution of people with a specific ethnic identity. In individual cases, consideration is given to the possibility that the objects circulated independently of people.⁷⁰ In many cases, a perceived clustering of the objects in a region where a specific ethnic group was located (often on the basis of a very limited number of indications in the texts, spread over a relatively long period) is presented as proof of the object's use as an ethnic marker.⁷¹ These analyses are often based on the presence of objects in specific areas. Often, no consideration is given to their non-presence in other regions, for which there may be various explanations. For instance, a close examination of the distribution of specific types of 5th-century swords, which are essentially grave finds, reveals both clustering and an intermingling of types. It also reveals the non-presence of swords in graves in areas where historians – rightly or wrongly – have located important 'Germanic' groups such as the Franks and Burgundians. Nor are they found in the Moselle valley, where a Roman-like polity existed.⁷²

The archaeological ethnic ascription theory is a combination of elements three, six and seven. However, the theory's foundation has been eroded. Historians have considerably revised their perceptions and interpretations of texts, just as archaeologists have revised their perceptions and interpretations of material culture.⁷³ One of the key concepts in both these developments is 'representation', including strategies of representation to create identities and ideas. In the next section, I will use one example of changed interpretations of written texts in order to elaborate on the interpretation of grave finds.

4 BURYING GROUPS AND RHETORICAL STRATEGIES OF REPRESENTATION

For archaeologists studying identities, the historiography of one particular category of texts, that of Saint's Lives, which shows an important shift in evaluation, may be of particular importance. These texts were initially considered of limited value because the genre – characterised by standard formulations, high-brow descriptions of the saints, copying etc. – made it impossible to extract a substantial amount of 'true' information on the life of the saint as an historical person.⁷⁴ The texts did not produce sufficient reliable information on the socio-economic practices at the time the saint lived. For this reason, it was not considered a useful exercise to take the texts at face value. Using copied elements to analyse in detail the relationship between different texts, it was possible to create a genealogy of the text and its textual descent, both of which indicated its value (read: 'limited' value) in the analysis of factual history.

⁶⁹ Theuvs/Alkemade 2000.

⁷⁰ Brather 2002.

⁷¹ Strangely enough, at the same time, the distribution and clustering in regions of some other types of objects is believed to reflect the activities of workshops in combination with 'consumer demand' of another type. Elaborate belts are a case in point.

⁷² Theuvs/Alkemade 2000, 462-466.

⁷³ The literature on the changing interpretations of material culture is growing rapidly. For a useful summary, see Johnson 2001⁵.

⁷⁴ In what follows, 'life' is written with a capital 'L' if the text is meant and with a lower case 'l' when the actual life is meant.

However, the evaluation of Saint's Lives changed considerably once scholars realised that these should not be perceived as distortions of 'reality' or combinations of false or copied information, but rather as 'arti-ficial' creations, textual constructions to be read or heard by specific audiences for specific purposes. In her seminal book *Sacred Fictions. Holy Women and Hagiography in Late Antiquity*, Linda Coon points out that Saint's Lives are not distorted descriptions of historical lives, but texts that reveal their authors' theological and didactic agendas.⁷⁵ It is almost impossible to reconstruct the actual historical person on the basis of these texts: they are 'sacred fictions'. Therefore, although not stated explicitly, one of the themes of Late Antique Lives of female saints is, according to Coon, the institutionalisation of the male priesthood and the masculinisation of the altar space.⁷⁶ In order to achieve their objectives, the authors used a number of literary strategies or rhetorical techniques such as inversion, paradox, transformation and exaggeration. When analysing the text, it is essential that we recognise and interpret these strategies. However, the authors did not operate in social and intellectual isolation. I will pass over the significance of the intellectual debts of authors in order to concentrate on the social context in which texts were produced. This context can be presented as a triangular relationship between the author, the audience and the main character of the text, who is usually an historical person.⁷⁷ An analysis of the relationships between each point on the triangle places the production of the text in its proper context. These relationships were characterised by the didactic purposes of the author vis-à-vis the audience, as well as elements of identification by the author and the audience with the main character – the saint – who was a model to be emulated. This process of identification may then create an identity for the audience, in this case often a monastic community. Thus the narrative exists in several forms: in addition to the product of the author, there are the forms in which it has been understood by the audience in subsequent periods up to the present day. Clearly, a complex relationship exists between the texts, the socio-political practices in different periods, intellectual traditions, political and theological goals and historical persons. For our purpose, an important element of Linda Coon's book is her analysis of the description of clothing as a literary strategy. The descriptions of clothing do not have an ethnographic character; their purpose relates to the theological and didactic agendas of the authors.⁷⁸ Can these insights help us to analyse the late Roman burial rites in relation to the creation of identities? I believe they can.

First of all, we have to realise that the material culture originating from graves is ritually patterned. We must accept that the ritual acts as a filter through which a meaningful selection of the available material culture is deposited in a grave. It is not correct to represent the set of grave goods as a reflection of available material culture or as a more or less exact copy of the clothing and weaponry of the deceased person in his or her lifetime.⁷⁹ The fundamental, incorrect point of departure in much interpretation of the burial rites of late Antiquity and the Early Middle Ages is that the dead are equated with the living. Reconstruction drawings of warriors with their clothing and weaponry which suggest that this was how they looked while alive miss the point, even if this attire is represented as 'Sunday or ceremonial clothing' and if elements of the grave goods were worn in life. The drawings reproduce a number of grave goods placed in the grave during a ritual, either hung on the body or placed next to it (e.g. many of the elaborate belts in the 4th century – why?). At best such drawings are representations of the clothed body of a dead person.⁸⁰

⁷⁵ Coon 1997. It was in fact Coon's monograph that inspired me to write the present paper.

⁷⁶ Coon 1997, xiv.

⁷⁷ Coon 1997, 5–13.

⁷⁸ Coon 1997, 29–41.

⁷⁹ See also Samson 1987; Treherne 1995; Halsall 1995.

⁸⁰ Worse still is the drawing of the 6th-century kitchen of the 'chief of Krefeld-Gellep', where the grave goods

have been taken out of the symbolic context of the burial rite and have been placed – functionally – in his kitchen. Obviously just returned from a day's work, the chief can be seen roasting a pig (what an appetite for a single (?) man: there is only one table setting), while being served by a man. The caption reads: 'Der Herr von Krefeld-Gellep Grab 1782 am häuslichen Herd' (*Die Franken* 1996, 669). This picture entirely ignores the

The graves of the Migration period in Northern Gaul and their contents are comparable to the Lives of Saints in that they do not permit a reconstruction of the actual living historical persons buried in the grave. Instead, they should be analysed in terms of the rhetorical strategies employed in relation to the political and ideological agendas of the burying group. Thus, the grave is neither a reflection of the social position of the buried person in his or her lifetime, nor a static symbolic representation of a specific, perhaps even ideal, social position. It is the product of a rhetorical strategy. To illustrate the implications of this position, we can state that Childeric's famous grave does not enable us to know him as an historical person, although most past research on his grave has been conducted with that goal in mind and has led to the type of reconstruction drawings mentioned above. What it does allow is an analysis of the political and ideological agenda of the burying group (Clovis?) and the ritual strategies involved. In fact, Childeric's grave is the result of an important ritual strategy in the creation of Frankish kingship.⁸¹ Childeric's identity as an historical person remains an enigma to archaeologists. Thus an analysis of the burial ritual must include an analysis of the triangular relationships between the authors of the ritual, the main character (the person to be buried) and the audience present at almost all burials. These relationships can be of a didactic nature and can involve elements of identification. For this reason, the burial may become a highly relevant cultural act that will itself be buried in the memory of those involved. But there is more.

In the end it is a dead body, a corpse, that is the essential component of burial rituals.⁸² The corpse is one of the elements in another triangle: one that includes the living and the mourners, the corpse and the burial, the soul and the dead.⁸³ An analysis of the burial ritual must therefore include an analysis of the rhetoric of clothing and the body in late Antiquity for reasons beyond simply establishing the possible ethnic identity of the deceased.⁸⁴ The transition from cremation to inhumation indicates that the body may have become a central element in a series of cultural constructions involving basic elements of the cosmological order of changing societies in Northern Gaul. The corpse may have been involved in the cultural construction of gender,⁸⁵ the cultural construction of the person with its distinctive constituents (body, soul, image), and the deconstruction of the person at death,⁸⁶ and – more than historiography has recognised to date – the cultural construction of ancestors (perhaps even different types of ancestors) in that rite of passage, the burial rite.⁸⁷ This last element may open up new avenues of research as the dead

ritual context of the grave goods by stressing exclusively the functional character of the objects and forgetting the reasons for their deposition in the grave during a ritual. One could elaborate extensively on the theoretical and modern ideological background of this drawing and its caption.

⁸¹ I have explained the basics of this position on Childeric's grave on two occasions, i.e. at the International Congress of Medieval Studies Kalamazoo 1999 (unpublished paper 'Sacred fictions and Childeric's grave') and at a round table conference in Paderborn 1999 (idem). See now also Halsall 2001, with the fundamentally similar question: 'what exactly made Clovis, presumably, bury his father in this way?' I accept his comments on my uncritical acceptance of the traditional date of burial (c. 481). My answer to the question was based on the theoretical considerations explained in Theuvs/Alkemade 2000 and those formulated here. My views go beyond

those of Halsall (others would say 'where there is no evidence...') and do not focus solely on the origins of the Merovingian kingdom as a political process, but on the conceptualisation of Merovingian kingship with the help of the burial ritual (the agenda). See also note 153. I hope to elaborate on this on another occasion.

⁸² Huntington/Metcalf 1979, 61-67.

⁸³ Huntington/Metcalf 1979, 66.

⁸⁴ Bazelmans 2002.

⁸⁵ In addition to the already established research tradition on gender constructions and representations in Late Antiquity and the Early Middle Ages (Coon 1997; Smith 2000), gender is now emerging as a research theme in late Roman and early medieval burial archaeology. See, for example: Effros 1996; Halsall 1996; Hadley/Moore 1999.

⁸⁶ Bazelmans 1999.

⁸⁷ Theuvs 1999.

body may not have been dressed as a past living person, but as a future ancestor in accordance with the skills required of that ancestor (protection: weapons; fertility: food, offspring?) in relation to the norms, values and ideas prevalent in certain societal contexts. All this may explain in a synchronic sense why burial rites took the form they did, but not why they changed. The diachronic element must be part of the interpretative model.

Traditional explanations for changes in burial rites, such as Germanic invasions or migrations, are inadequate.⁸⁸ Instead, we have to conceptualise the lines along which groups brought about changes in burial rites in certain contexts. Nor does interpreting changes as the result of an unconditional takeover of strange – ‘Germanic’ – elements seem to be an acceptable explanation. This interpretation owes much to the concept of homogeneity, which hypothesises that cultural elements have an intrinsic meaning and remain unchanged even after they have been taken over.⁸⁹ It implies that actors do not have the intellectual capacity to reflect on and influence their situation; they simply take things over. However, elements do change after being observed, through a process of interpretation, reflection and cultural appropriation. They thus become new elements in the cultural constructions of those who have become the ‘authors’ of new ritual repertoires geared to new societal contexts.⁹⁰ This process of interpretation may be based on the perception of elements from different cultural contexts that merge in the creative process. Thus a group defining its positions and values in Late Antique Northern Gaul may have as their cultural sources the cultural values of Roman aristocracy, of the aristocracy of ‘barbarians’, Christian values and possibly others. The outcome of the reflective process is neither Roman, nor Germanic, nor Christian, nor pagan nor barbaric; it is that of a society, or segment of society, in Northern Gaul in the 4th and 5th centuries that I would prefer not to label.

To end this section, I would like to stress that an analysis of burial rites in Northern Gaul in late Antiquity and the Early Middle Ages should encompass two major fields of enquiry: that of social practices of the time and that of the definition of concepts, ideas, values and norms.⁹¹ Most research to date has addressed short-term social practices involving concepts such as ‘social stress’, ‘legitimation of power’, ‘social instability’, ‘power exercise’, ‘intergenerational transfer of power’, ‘social competition’, and ‘competitive display’. But analysis of burial rites should go ‘beyond power’⁹² to analyse the very definition of concepts central to the world view of social groups as observed in new ritual repertoires. Not everyone in late Roman times may have been aware of these concepts – perhaps no-one. If we had the opportunity to carry out anthropological field research in late Roman times and asked participants why they were performing the rites as they did, we might be disappointed by the answers.⁹³ However, this is no reason for not coming up with answers ourselves.

⁸⁸ The concept of ‘Mischkultur’ simply states that two different cultural homogeneous groups co-exist in the same region without a serious cultural exchange (at least on the material level).

⁸⁹ The traditional argument goes: the elements may not change, but the group that uses them is changing (acculturation). I doubt whether elements remain unaltered after having been taken over by other groups and, for that theoretical reason, it is not very rewarding to search for the origins of these elements in order to establish where people came from and which original thoughts were introduced in the new context.

⁹⁰ Theuws 2000.

⁹¹ Similarly, Heinrich Härke proposed that weapon graves should be seen not as simple warrior graves, but as graves in which the concept of the warrior is defined (Härke 1990, 1992). See also Theuws/Alkemade 2000 on the sword graves of 5th-century Gaul.

⁹² Bazelmans 1999, 189–191. Also in order to avoid too instrumentalist an interpretation of burial rites.

⁹³ They would be answers that anthropologists are also accustomed to hearing, such as: ‘this is the way it should be done’ or ‘this is how we have performed the rites since time immemorial’ or ‘this is how we learned to perform the rites’. In other cases the answers do not constitute what we would call ‘scientific’ or ‘scholarly’ explanations.

Ultimately, we are left with the fundamental question: what were the political and ideological agendas of the burying groups and in what perception schemes were these agendas embedded? In the next section, I will examine a specific type of burial in Northern Gaul in the 4th century, the so-called weapon burials that have been interpreted in the past as those of Germanic soldiers/warriors. I will try to offer an alternative interpretation for this burial rite.⁹⁴ I will first survey the evidence for weapon burials and then analyse different aspects of them.

5 FOURTH-CENTURY WEAPON BURIALS IN NORTHERN GAUL

Any analysis of these graves must still take as its starting point Horst Wolfgang Böhme's seminal study *Germanische Grabfunde des 4. bis 5. Jahrhunderts zwischen unterer Elbe und Loire. Studien zur Chronologie und Bevölkerungsgeschichte*, which was published in 1974.⁹⁵ Although his inventory of weapon graves in Northern Gaul is no longer up to date (new weapon graves have since been discovered), the insights into the composition of the graves and the overall distribution pattern have changed little. We observe this if we compare the maps presented in 1974 with the ones Böhme published in the 1985 volume about the fortress at Vireux-Molhain along the Meuse in Northern France and in the 1996 exhibition catalogue *Die Franken*.⁹⁶ Although the quantity of evidence has increased, the qualitative composition of the evidence presented in 1974 remains valid. Böhme presented all types of weapon burials in tabular form, which I reproduce below in order to introduce the evidence (table 1).

A few comments are necessary. In the first place, as has been explained above, a chronological distinction must be made between 4th and 5th-century graves. Fifth-century weapon burials form a minority in the whole set: they are mainly found in the northernmost part of Northern Gaul and are generally 'richer' in terms of number, type or quality of weapon. This group includes, for example, the famous sword grave 43 of Krefeld-Gellep.⁹⁷ The sword graves in the table date mainly from the very late 4th and 5th century (fig. 2), which means that the great majority of 4th-century weapon burials consist of graves with an axe, or a lance, or a combination of the two. New discoveries (e.g. in Vron and Vireux-Molhain) confirm this picture. It would not be correct to say that all weapon graves that date from the period after the turn of the 4th century are graves with complex sets of weapons. The boys' (!) graves of Cologne Saint-Severin and Utrecht show that graves containing only axes date up to the middle of the 5th century.⁹⁸ However, the overall trend was a decrease in the number of weapon burials as time went by, with such burials becoming rare after c. 410/25. Here we encounter our first problem, and one which has been insufficiently addressed until now: at a time when the number of Germanic warriors settling in Northern Gaul was supposedly on the increase, the number of graves ascribed to Germanic warriors decreased.

A related problem is that of the rarity of weapon burials altogether. If we deduct the 29 sword graves in Böhme's table from the total number of weapon burials, we are left with 100 graves for much of the

⁹⁴ Recent years have seen alternative interpretations that discard the traditional Germanic warrior interpretation. I will try to explain where my interpretations differ from these.

⁹⁵ Böhme 1974.

⁹⁶ Böhme 1985 and Böhme 1996. The 1996 map has one more dot than the 1985 map.

⁹⁷ Böhme 1996, 97 for a colour photograph of the contents of this well-known grave. Pirling 1966.

⁹⁸ Cologne: Päffgen, 1992, II, 227-239 and 1992, III, tables 49, 50 and 124. Both boys were buried in sarcophagi. Utrecht: De Groot 1993, 10-13. According to the radiocarbon dates of their skeletons, the Utrecht boys must have been buried between AD 410 and 443. See also: *Een levensteken uit de vijfde eeuw. Het grafveld aan het Pieterskerkhof*, Utrecht 1991.

Weapons	total number of graves	west of Rhine	east of Rhine
sword, lance, axe, shield	1	1	
sword, lance, shield	6	4	2
sword, axe, shield	1	1	
sword, lance, axe	4	4	
sword, shield	2	1	1
sword, lance	1	1	
sword, axe	5	4	1
sword	9	7	2
lance, shield, axe	1	1	
lance, axe	24	24	
lance	17	13	4
axe	58	52	6
Total	129	113	16

Table 1. The composition of the sets of weapons in weapon graves in Northern Gaul and the adjacent Germanic territories in the 4th and first half of the 5th century, according to Böhme 1974. Grey: graves with no swords.

4th and for the beginning of the 5th century. That amounts to one grave per year. This figure has now changed, but not to such an extent that it alters our ideas about the number of performances of the ritual. If we had 1 % of the total number of original weapon burials, there would be about 100 such burials per year for the whole of Northern Gaul north of the Loire. The conclusion must be that weapon burials were a rare phenomenon and it would be fair to conclude that the majority of the population never saw one. In my opinion, this fact has not been sufficiently incorporated in the analyses to date.

A further point well illustrated by Böhme's table is the limited range of weapons deposited in 4th-century graves. As the majority of the sword graves date from the late 4th and 5th centuries, we have to conclude that over half of the 4th-century graves contained a single axe (a bow and arrows may have been present but Böhme did not include them in the table). A quarter contained an axe and a lance; a small number had a single spear. Exceptional graves may have had a sword or shield. To my knowledge, this remarkable limitation in the choice of weapons has not been dealt with sufficiently either.

Axes and lances are interpreted without further ado as weapons, a functional interpretation probably inspired by the presence of axes in later Merovingian graves alongside other weapons such as swords, shields, saxes and angons. Böhme claims the following: 'In den Kriegergräbern des 4./5. Jahrhunderts treten unter den Angriffswaffen am häufigsten Äxte auf die sich in verschiedenen Formengruppen gliedern lassen.'⁹⁹ In fact, these lines contain a circular argument: because the graves are those of warriors, the objects must be weapons, and the graves are therefore those of warriors. There are two consequences of this functional interpretation of the objects as weapons: 1) the deceased are identified beyond doubt as warriors and soldiers; and 2) other uses and symbolic meanings of the objects are not considered. The

⁹⁹ Böhme 1974, 104.

result of the last observation is that it rules out other interpretations of the act of depositing an axe or a lance in a grave during a ritual.¹⁰⁰

A functional interpretation is also given to a number of locations of ‘weapon’ graves. Some of them are found near walled towns (e.g. at Vermand), and others in direct proximity to a hill fortress (e.g. near Vireux-Molhain or Furfooz).¹⁰¹ They are thus found near defensible sites, which are usually described in military terms and which supposedly occupied a place in the comprehensive late-Roman military (in depth) defence system.¹⁰² The next step in the interpretation is: the graves of the men with ‘weapons’ are those of soldiers that formed the complement of the fortress or walled town in question. Böhme’s conclusion with regard to Vireux-Molhain reads as follows: ‘Un rituel funéraire inhabituel – tombes à incinération, offrandes d’armes- et des dons funéraires remarquables et peu conformes au contexte normal de l’Antiquité romaine tardive – fibules féminines, ceinturons militaires à boucles à têtes animalières, briquets et silex, ciceaux – assurent l’origine germanique de ces soldats incorporés dans l’armée romaine avec leurs familles’.¹⁰³ Périn and Feffer qualified the men buried near the fortress of Vireux-Molhain as ‘gendarmes», qui étaient des soldats de métier et relevaient de l’organisation militaire romaine’.¹⁰⁴ However, Périn makes an important observation to which I believe the research pays insufficient attention. The small number of soldiers buried in these cemeteries cannot have been the total complement of the fortress; the rest must have been buried elsewhere, as will have been the case for most similar fortresses such as Rhenen, Haillot, Furfooz, Cortrat and Vert-la-Gravelle.¹⁰⁵ We can add that the presence of women’s and children’s graves in these cemeteries shows them to be the burial grounds of families. As we will see later, there is another way to interpret this choice of location.

My last comment on the interpretation of these graves concerns the Germanic ethnic identity of the deceased. It is in fact quite difficult to extract from the different analyses of the burials the exact arguments for them being *Germanic* ‘weapon’ graves. This dogma is so entrenched in modern research that hardly anyone bothers to question its basic assumptions; scholars simply reproduce them. The above quotation from Böhme is an excellent example of this. The arguments emerge from the ‘Roman-Germanic’ dichotomy and to some extent have both a positive and negative character – negative in the sense that they result from a perceived knowledge of what is Roman. That which is not considered Roman – such as carrying weapons in life (after completing military service) and in death (which is considered by archaeologists to be prohibited for Romans) – must be Germanic. Therefore, anyone buried with ‘weapons’ must be a Germanic man and soldier. Although only a few generations before the 4th century the majority of the population in the Roman West was cremated, inhumation is considered the Roman manner of burial. Therefore, anyone cremated in the 4th and 5th centuries must be Germanic, the more so because cremation was the burial rite commonly practised in the Germanic territories east of the river Rhine in the 4th and early 5th centuries.¹⁰⁶ Therefore, those cremated west of the Rhine probably had their origin in these Germanic territories. Positive interpretations are the perceived origin and importation of specific objects in Gaul from territories on the other side of the river Rhine or the production of *fibulae* in Gaul for Germanic women with their distinct Germanic tastes. These arguments do not stand up to closer inspection. It is not my aim to counter the existing arguments in detail as Halsall has

¹⁰⁰ For that reason, I place weapons between quotation marks when referring to them.

¹⁰¹ Vermand: Böhme 1974; Vireux-Molhain and Furfooz: Böhme 1985.

¹⁰² The comprehensive nature of the defence system is based on Luttwak (see for instance Willems 1984, 274-275; Brulet 1990, 337), but has already largely been abandoned (see, among others, Whittaker 1994, 132-191).

¹⁰³ Böhme 1985, 76.

¹⁰⁴ Perrin/Feffer 2001³, 99. It is highly interesting to read the separate text box on Vireux-Molhain by Périn and Feffer for it summarises rather well the classical interpretation of 4th-century weapon graves.

¹⁰⁵ Périn/Feffer 2001³, 99.

¹⁰⁶ Van Es /Wagner 2000, 122-123.



Fig. 2. Late Roman inhumation grave from Bonn-Jakobstrasse. The sarcophagus contained a skeleton as well as a crossbow brooch with Chi-rho (1), a glass cup (2), a flask (3), belt fittings (4-6), a knife (7) and a sword (8). After Haupt 1973.

already done so.¹⁰⁷ It may be useful, however, to point out some internal inconsistencies in the traditional explanation that are founded on the application of certain criteria. If cremation is a Germanic rite par excellence, it is not clear to me why most men and women whose graves contained weapons and Germanic jewellery were buried rather than cremated.¹⁰⁸ Consider, for instance, the highly interesting

¹⁰⁷ Halsall has demonstrated that the theory regarding the origin of Germanic brooch types from Germanic regions east and north of the Rhine is untenable (Halsall 1992, 2000).

¹⁰⁸ The notable exception is the cemetery of Gennepe-Touwslagersgroes in the Netherlands (IVd-VA), which consists entirely of cremation graves (Hiddink, Theuvs

grave at Bonn Jakobstrasse (fig. 2).¹⁰⁹ The dressed corpse of a man¹¹⁰ was buried in a sarcophagus (!) with a belt around his waist, a small glass bottle and a drinking cup near (or in?) his right hand, a crossbow brooch (on his left shoulder?), a sword (definitely a weapon) and a knife (probably in a small pocket on the scabbard) near his left arm. Of great interest here is that the crossbow fibula is incised with a Chi-rho as the bottom of the glass cup also appears to be. For advocates of the ethnic ascription theory, the man is at once a Roman (he was buried in a sarcophagus), a barbarian (there was a sword in his grave) and a Christian (the grave contained unmistakably Christian objects), even though in their opinion some of these categories are mutually exclusive.¹¹¹ Rather than qualifying this man as a Roman, a 'Reiternomade', a German or a Christian, it is more interesting to analyse the rhetoric of this specific burial in the context in which he was buried. In the next section, however, I will not go into the details of individual burials, but will deal with the group of 4th-century 'weapon' burials as a whole. In analysing the rhetoric of late Roman 'weapon' burial rites, we must take into account three interlocking elements, each of which is very difficult to grasp. They are 1) the material culture used (and the different use contexts of those objects and the total field of meanings attached to it); 2) the various acts performed (including the audience present, the gestures, the phases of the ritual, etc.); and 3) the location of the burial (and the total field of meanings attached to the site). Because it is difficult to grasp the totality of acts performed from the moment it became clear that a person was going to die or had died to the final rituals after burial, I will concentrate here on the first and last element.

6 'WEAPON GRAVES': MATERIAL CULTURE AND LOCATIONS

What is the meaning of the deposition of 'weapons' in graves? First of all, if we wish to understand the total range of uses and meanings, we need to abandon the qualification 'weapons'. Weapon is just one such use. Instead, we should refer to the objects by more specific names such as 'axe' or 'lance' and speak of 'axe and lance graves'.

THE AXE

One fundamental question is: if in the 4th century axes and lances were deposited as weapons to qualify the person in question as a warrior, why in most cases was only the axe selected from the full range of available weapons? Wouldn't a sword or shield have been a more likely choice to qualify the warrior as

and Zijlstra, unpublished MA-thesis). After c. 450 there was a transition to inhumation.

¹⁰⁹ Haupt 1973 has already struggled with the contents of the grave in relation to traditional interpretations. Ernst Pohl concludes that the man possibly had a 'reiternomadische Herkunft' on the basis of the belt fittings, the origin of the crossbow brooch from middle Danube workshops, and the presence of the sword, which makes him a 'Transdanubian'. The glass objects and the knife are supposed to have originated from workshops in the Gallo-Germanic provinces. I do not believe there is any reason to select one object as being more important

than others in determining origins. We cannot answer the question as to where the man was born or where he came from on the basis of the grave finds. He was supposedly buried in a cemetery in Bonn with civilian characteristics (south of the military camp) rather than in the cemetery to the west where 'eine germanische Milizbesatzung des 4. Jahrhunderts samt Familien bestattet worden war' (Pohl 1991).

¹¹⁰ Sex determination not on the basis of physical-anthropological research.

¹¹¹ With regard to these criteria, see Stein 1974; Ament 1978 and Périn's comments on their hypothesis (1981).

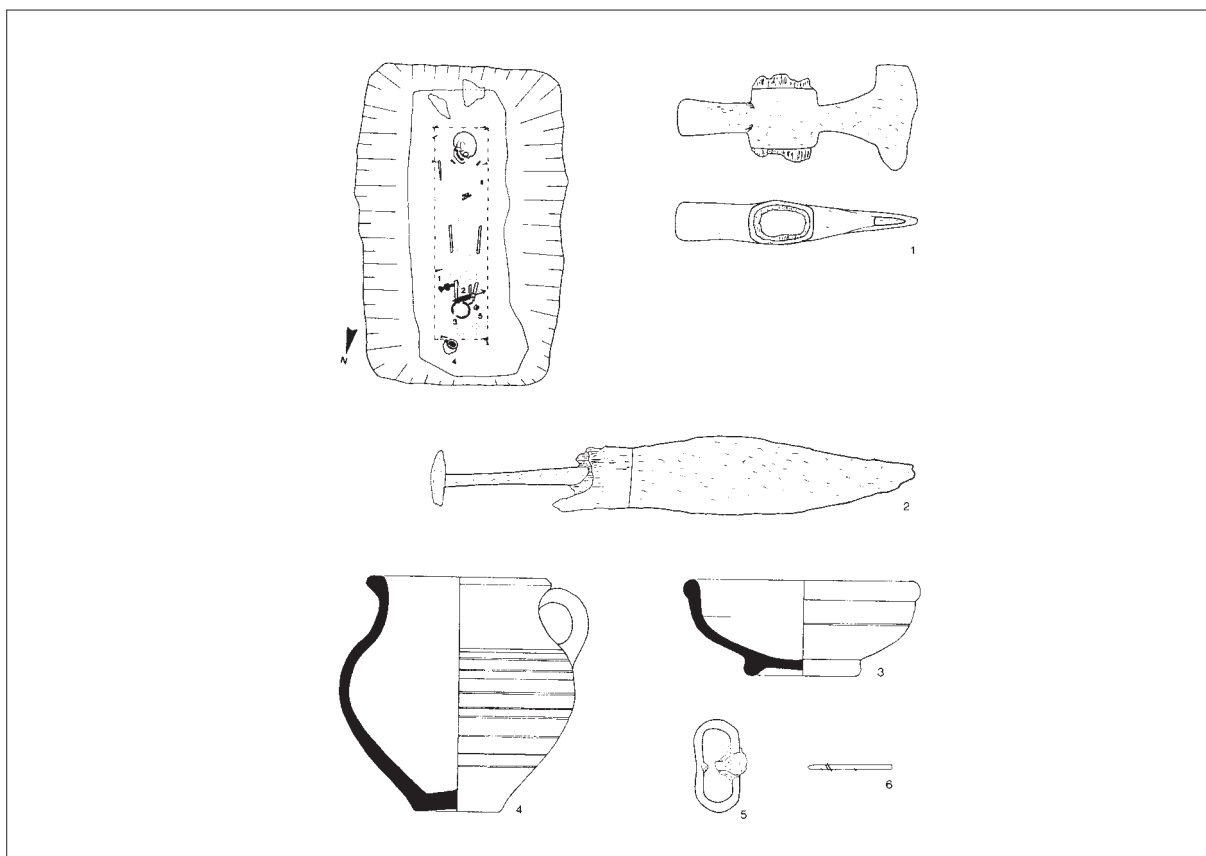

Fig 3. Late Roman inhumation grave (nr 183) from Vron (dép. Somme, France) with axe (1), knife (2), pottery (3-4), belt fittings (5) and an object with unknown function (6). After Seiller 1992.

such? Yet that choice was hardly ever made in the 4th century. Perhaps there was never any intention of placing a weapon in the grave, but instead, an axe – an object with a far richer symbolic idiom. The axe had many uses and many symbolic meanings. It was military idiom on the one hand, and an agricultural one on the other.¹¹² The axe refers to chopping wood, or more importantly felling trees – in other words, clearing land. It relates to the concept of fertility, the capacity to separate one thing from another and it was rated positively.¹¹³ However, it may also refer to battle, to decisions about life and death, and to the ability to provide protection.¹¹⁴ This dual meaning will have been the main reason for depositing axes in graves. In ethnic terms, axe deposition need be explained neither as a Germanic custom (as in traditional explanations) nor as a Roman one (as Halsall does). The axe as a symbol encompassing both military and agricultural meanings had been used since prehistoric times in many societies in Europe. One of its attractions is that it appealed to the systems of meanings of different peoples. Instead of arguing for its specific ethnic interpretation, I prefer to reverse the whole interpretation. I see it as an object with multi-

¹¹² See Pastoureau 1993, 32-34 for similar thoughts on axes later in the Middle Ages. This seems to be clearly illustrated by the presence of axes similar to those found in graves in hoards both west and east of the Rhine that contain mainly agricultural implements. See for instance the hoard of Osterburken (Baden-Württemberg, Germany), where a large number of agricultural implements

as well as two swords were found. Henning 1985 did not interpret the axes as weapons, but rather as part of the set of agricultural implements.

¹¹³ Pastoureau 1993, 34.

¹¹⁴ These are the traditional connotations used in the interpretation of axes in later Merovingian graves.

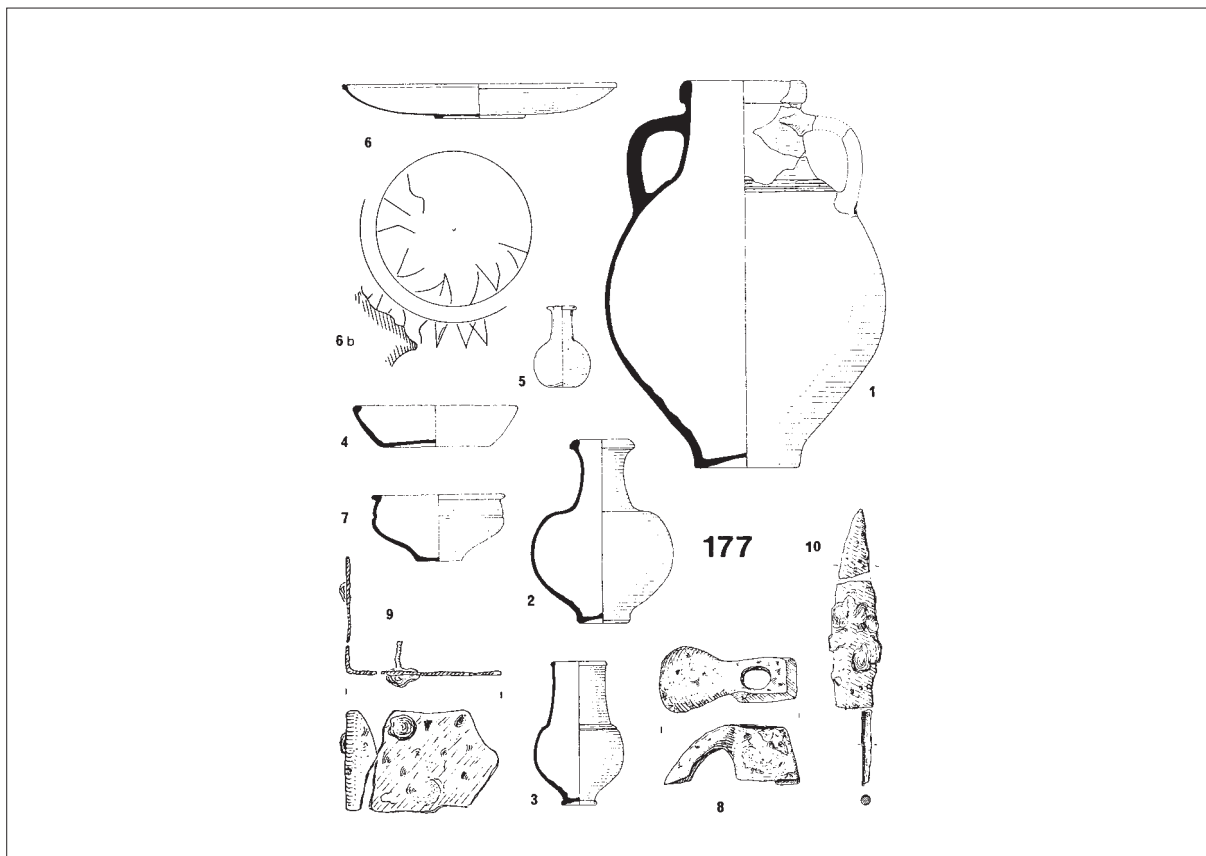

Fig. 4. Late Roman cremation grave (177) from Tongres with pottery, glass flask, bronze basin and a tool (end of 3rd century). After Vanvinckenroye 1984.

ethnic connotations, making it an ethnically ‘neutral’ object eminently suited to the rhetoric of a new burial rite in late Roman Gaul, which resulted from an interpretative process involving the appropriation of elements from different cultural sources. The deeper meaning of the deposition will be clear once I have dealt with the other objects. If we look at axes placed in graves, we observe a great variety of forms. Many axes are quite small, and not particularly impressive on the battlefield; others seem quite useless for that purpose but are well suited for working wood (e.g. the axe in grave 183 from Vron (fig. 3) and the tool in grave 177 from the south-west cemetery in Tongres (fig. 4)); indeed, quite a number are well suited to splitting skulls.¹¹⁵ Finally, the contents of grave 29 from Tongres, which yielded an axe in combination with a pair of smith’s tongs, may show that axes need not be interpreted as weapons (fig. 5).

THE LANCE

The lance also had many uses and meanings. It was a weapon in the sense that one could kill with it but, more than that, it was a symbol of authority in late Antiquity and the Early Middle Ages, interestingly enough, in both Roman and barbarian contexts.¹¹⁶ Roman emperors are depicted with a lance on coins and silver dishes such as the famous mid-4th century dish in the Hermitage in Leningrad, which shows

¹¹⁵ See Böhme 1974, 104-110.

¹¹⁶ For example, Gasparri 2000, 99-101.

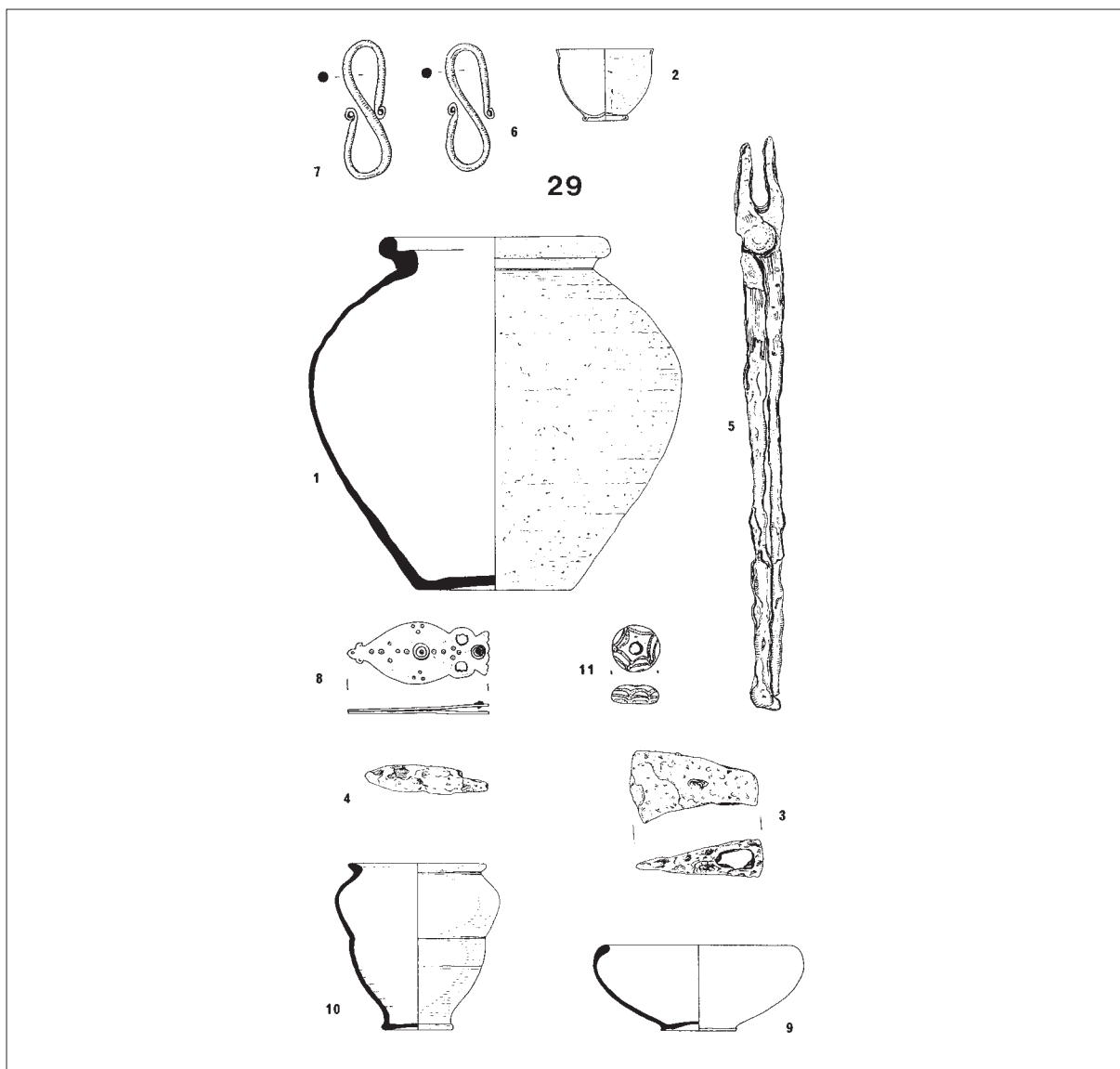

Fig. 5. Late Roman cremation grave (29) from Tongres with pottery, glass cup, knife, bead, bronze strap end, 'S-shaped hooks', an axe and a pair of smith's tongs (third quarter of 4th century). After Vanvinckenroye 1984.

the triumph of Constantius II.¹¹⁷ Germanic kings are associated with lances.¹¹⁸ Some of the lances in the graves refer to another highly relevant field associated with the lance, namely the hunt. These lances are denoted by the German term 'Saufeder' and are characterised by two 'wings' just below the blade.¹¹⁹ Known depictions of such lances used in the hunt include the one on a bronze dish in an axe grave (!) from Saint-Rimay (dep. Loir-et-Cher) in central France, which also contained pottery and glass cups (fig. 6).¹²⁰ I will come back to the hunt after I have dealt with another set of objects related to this activity: bow and arrows.

¹¹⁷ Kent/Painter 1977, 25.

¹¹⁹ Böhme 1974, 101-103.

¹¹⁸ Gasparri 2000. See also the famous signet ring in Childeric's grave in Tournai which represents Childeric holding a lance.

¹²⁰ Böhme 1974, 107.



Fig. 6. Late Roman grave from Saint-Remy (dép. Loir-et-Cher, France) with an axe, a bronze bowl depicting a boar hunt, pottery, and glass and bronze bowls and a deposited belt. After Böhme 1974, 107.

BOW AND ARROWS

Although it is easy to kill a person with a bow and arrows, Böhme did not include them in his list of weapons because they refer above all to the hunt.¹²¹ In his opinion, a bow and arrows cannot be used unequivocally to indicate the Germanic origin of the deceased person in whose grave they are found: Roman aristocrats liked to hunt as well. However, by leaving the bow and arrows out of the spectrum, we lose sight of the symbolic relationship between the various objects deposited in weapon graves. A bow and arrows are crucial indicators of the meaning of the rhetoric of the late Roman burial rite. They point to the hunt, and it is the hunt that provides a number of interesting clues.

THE HUNT

Hunting was a favourite leisure-time activity of late Roman aristocrats. Its importance to their lifestyle¹²² is well represented in the art of the late empire.¹²³ The genre of the hunt is a familiar one in the mosaics

¹²¹ Böhme 1974, 110.

¹²³ Brown 1980, 23-24.

¹²² On the concept of elite lifestyle, see Theuvs/Alkemade 2000, 411-417.



Fig. 7. Glass cup depicting a boar hunt from grave 61 of the cemetery in the Jakobstrasse in Cologne (mid-4th century). After Friedhoff 1991.

of large villas and palaces in east and west.¹²⁴ It is a central theme in the later palace mosaics in Constantinople,¹²⁵ but can be found in less ostentatious country houses as well. However, these mosaics were not just carpets that illustrated favourite activities or displays to impress visitors. Hunting scenes can also be found on glass bowls such as the ‘deer hunt cup’ from Andernach dating to the first half and middle of the 4th century and the mid-4th century ‘boar hunt cup’ from grave 61 of the cemetery in the Jakobstrasse in Cologne (fig. 7).¹²⁶ Such bowls are mainly found in graves and it has been suggested that they were specially made for use at a funeral.¹²⁷ Hunting scenes are also found on another element associated with burial rites: sarcophagi.¹²⁸ A final example of a hunting scene on an object relevant to our inquiry is the depiction of a boar hunt on a Late Roman elaborate belt set whose provenance is unknown (possibly Intercisa, Hungaria) but which is now in the Diergardt collection in the Römisch-Germanisches Museum in Cologne.¹²⁹

Hunting was a source of great prestige. The presence of hunting scenes in late Antiquity refers to a re-evaluation of life in the country and especially to mastery over the world of animals and nature.¹³⁰ Hunting is domination, having control over the world. We can elaborate still further on this idea. Three

¹²⁴ Dunbabin 1999 with many examples.

¹²⁵ Jobst/Erdal/Gurtner 1997.

¹²⁶ Andernach: Perse 1991; Cologne: Friedhoff 1991, 136–137, 226, table 70 with inscription: *Escepe me placebo tibi*.

¹²⁷ Some of them, like the Andernach bowl, have inscriptions referring to overcoming death (Andreae 1980, 132):

V(i)ncas cum t)uis.

¹²⁸ Andreae 1980.

¹²⁹ *Spätantike und frühes Christentum* 1984, 633–636; Bullinger 1969, cat nr. 163, table 42,1.

¹³⁰ Closely related are the wild beast games in arenas and their artistic representations.

aspects make the hunt interesting with regard to the burial rites of Northern Gaul. The point of departure is that the hunt was a highly regulated activity involving considerable protocol and ceremony. First, the hunt allowed the leading men of society to demonstrate leadership and courage (*virtus*) in a relatively 'safe' environment outside the context of armed combat and battle. Second, the hunt represented and reinforced the social hierarchy, as different activities within the hunt will have been reserved for different men (the iconography indicates that it was an all-male event). It must have been clear who was a leader and who a follower. Third and most important for our case, although to my knowledge it has not been discussed in the literature, the hunt allows for representations of claims on territories: hunting is organising the landscape. This reference to the hunt in the burial ritual is highly relevant in relation to the presence of axes that refer to clearing land.

Hunting, however, has yet another important symbolic connotation. Hunting scenes on sarcophagi relate to the concept of overcoming death and the completion of life.¹³¹ The ferocious and dangerous animals that are hunted (lion and boar) are equated with death because they can bring death. The killing ability of these animals is made explicit on the sarcophagi in the depiction of a member of the hunting party lying on the ground, his life threatened by the animal attacking him.¹³² By killing the hunted animal, the hunter overcomes death. In doing so, the hunter (in fact the person who had the sarcophagus made) represents himself as a hero with *virtus*. As Andreae states, there is a 'Heroisierung im Akt der Überwindung des Todes'.¹³³ This process of 'heroicisation' of the deceased person relates to his victory over temporal existence. He (for the hunters involved are men) is transferred to the world of eternal beings. Thus there is a direct relationship between the dead, death, funeral rites, the meaning of the hunt and the concept of eternity.¹³⁴

AN INTERIM CONCLUSION

What does this tell us about the rhetoric of the burial ritual? First of all, the symbolism of the axe, the lance and bow and arrows is tightly interwoven. Axes, lances, and bows and arrows should not be regarded simply as weapons: they are key elements in the sophisticated symbolism of embedment in the landscape, both cultural and physical. Central to this is the representation of claims on land, symbolised by placing in the grave both an axe (perhaps a special reference to the reclamation of those lands and to their fertility) and a bow and arrow (referring to the hunt, with its connotations of landscape). Moreover, the latter objects also refer to mastery over the world, more specifically over the new lands controlled by the family. The lance adds to this image, for it was one of the symbols of authority par excellence and was widely used in the hunt. Here I would like to stress how my interpretation of this ritual differs from that of Halsall. The point I am trying to make is that the ritual's prime objective does not relate to local competition and lavish display at the funeral in order to secure power positions at a local level. We will see later that we can even question the identification of these men as local leaders and the nature of these burials as lavish, with the exception of some later sword graves. If local competition were the prime incentive, we might have expected many more such burials. Instead, the ritual was about defining new

¹³¹ Andreae 1980, 41, 132, 134–135.

¹³² Andreae 1980, 135.

¹³³ Andreae 1980, 135. Andreae sees this as the result of the merging of 'der sepulkralallegorischen Tradition der mythologischen Jagddarstellungen mit dem Virtussymbol der Löwenjagd, in dem der Löwe den Tod verkörpert'.

¹³⁴ Andreae 1980, 53. It is surprising that the iconography

and symbolism of the hunt has not become part of the Christian symbolic repertoire. There is an additional element that may point to eternity being an element in the 'programme' of representation on sarcophagi that depict hunting scenes. Several of them feature a hare nibbling some grapes, which is generally interpreted as a symbol of immortality.

claims on land in a way that had not been done before. It was about conceptualising new and different forms of attachment to the landscape. However, some elements of the ritual were clearly appropriated from the world of the aristocracy by groups who were probably not aristocratic themselves.

The meaning of the ritual may have altered over time, especially in the late 4th century, when the nature of 'weapon' burials was changing and new elements such as hill fortresses became associated with them. I have already made several references to one site that can serve as an example: Vireux-Molhain, on the left bank of the Meuse in Northern France.¹³⁵ The cemetery that dates from the late 4th and first half of the 5th century is contemporary with the fortress. The graves, some of which have been destroyed as a result of road building, cannot have numbered more than about 60 in total (47 have been found, many of them disturbed or robbed; four are cremation graves). The graves are those of men, women and children from no more than 3-5 families of two or three successive generations. The number of male graves with axes and/or lances is limited to five; a metal ornament from a sword scabbard was found in one grave, but no sword.¹³⁶ One grave containing a lance belonged to the first phase of the cemetery (late 4th century), one grave with an axe to the phase around 400, while all other graves with an axe and the possible sword-grave belong to the first half of the 5th century. This can hardly be interpreted as the cemetery for the military complement of the fortress, as suggested by the excavators and later commentators. An alternative suggestion is possible, one that takes as its starting point the ability to provide protection rather than military defence. It is no coincidence that the axe, lance, bow and arrow burials near hill fortresses date from the late 4th century rather than an earlier period. It was a period when institutionalised state systems of protection were slowly weakening.¹³⁷ The choice of location of the burials near these fortresses seems to me highly symbolic. As already suggested, they are the graves of families who claimed lands and positions of authority, but some added to this their ability to protect as a major qualification of their position. These people appear to have become leaders of their community through their ability to provide protection in the form of a fortress. The new, more lavish sword graves (which contain objects that are undeniably weapons) are also directly related to this new 'ethos'.¹³⁸ It is important therefore to distinguish between the burial rites of the 4th century and those of the later 4th and 5th century, in which I see a further development, not so much in terms of local competition and social stresses, but in the conceptual definition of what local leadership was about (although in special circumstances, as we shall see).

Having analysed the theoretical and methodological background to the interpretation of late Roman 'weapon' burials, I conclude that the graves of men in which axes, lances and bows and arrows were deposited have a rhetoric that relates to the representation of *new types* of claims on the land and positions of authority (to which later was added, in exceptional cases, the ability to protect), and not to the ethnic Germanic identity of the person in question or his status as a warrior. The accent is on the novelty of the type of claims. There is no indication that these men were of Germanic origin; that is not the message conveyed by the deposition of axes and lances. The choice of these particular items seems a delicate one since objects that unequivocally convey a message of weaponry (swords, shields and daggers) have been carefully avoided. The men in the graves could have been of Germanic origin, but they could equally have come from the region itself, from elsewhere within the empire, from territories further south or from England. The grave goods and the burial ritual simply do not inform us of their region of origin or their ethnic identity. There is no indication either that these men were warriors: that is not the message conveyed by the deposition of axes and lances. Perhaps it became the message at a later date, when swords and shields were also deposited, but even then I prefer to interpret those acts as representing the

¹³⁵ Lémant *et al.* 1985.

¹³⁶ Probably due to a disturbance of the grave.

¹³⁷ With regard to the burial rites: Halsall 1992, 2000.

¹³⁸ Theuvs/Alkemade 2000.

ability to protect rather than the warrior status of the man in question during his lifetime, although the two elements are not mutually exclusive. We are therefore unable to reconstruct the ‘Germanisation’ and/or the ‘militarisation’ of the countryside on the basis of this evidence. Nor do the ‘weapon’ graves seem to be an element of competitive display as Halsall suggests; instead, they represent a rhetorical strategy in the conceptualisation and creation of new claims on the land.

CLAIMING LANDS: WHAT LANDS, BY WHOM?

In this section I will first comment on Böhme’s distribution map of ‘weapon’ burials in Northern Gaul.¹³⁹ The distribution of ‘weapon’ graves has always been interpreted as an undifferentiated phenomenon reflecting the settlement of Germanic soldiers/warriors on Roman territory. Because the general distribution is thought to coincide with the area where Germanic federates can be expected to have settled (north of the Loire), no attempt has been made to analyse in more detail the distribution of ‘weapon’ graves over Northern Gaul. What follows is a first attempt.

It is immediately apparent from figure 8 that ‘weapon’ graves are distributed very unevenly over Northern Gaul. In some regions, no such graves have been found to date, in others they are occasionally present and in still others they are more abundant (bearing in mind the small total number of graves). To illustrate different densities in the distribution of ‘weapon’ graves, I have added shades and a line to the distribution map.

We can identify four areas where the graves are concentrated: first, the central Meuse valley; second, the upper Somme valley; third, the region to the north in the departments of Pas de Calais and Nord; fourth, the central Marne/Aisne valley. Outside these areas the distribution of ‘weapon’ graves quickly thins out. The upper Moselle valley and the region south of the Ardennes can perhaps be regarded as areas with a higher concentration of graves, but their distribution is less dense. Hardly any ‘weapon’ graves are found between these regions, and there are large areas devoid of graves despite clear habitation. Why? Although it is usually claimed that ‘weapon’ graves are found in the south, up to the river Loire (a formulation from a northern, Germanic perspective), they are most definitely rare south of the river Seine. They are also found on the river Rhine, but we would expect many more of them if they were associated with Germanic soldiers/warriors in the service of the Roman army. Instead, the distribution map shows that ‘weapon’ graves ‘shy away from’ the military zones on the Rhine and the Saxon shore in the north. I have indicated this with a line that encircles all regions with concentrations of ‘weapon’ graves. That there was an uneasy relationship between ‘weapon’ graves and the military was already clear from the fact that no weapon graves have been found in the cemetery of the Saxon shore fort of Oudenburg in Belgium, although they are found near the fortress of Krefeld-Gellep on the Rhine (but not in large numbers compared to the total number of graves found). There may be specific reasons why weapon graves are absent in certain areas like Toxandria, where the Franks are said to have settled and which we now know underwent a resettlement phase in the late 4th century that lasted until about the third quarter of the 5th.¹⁴⁰ However, in most parts of the region, no graves have yet been found. There may be quite different reasons for the absence of ‘weapon’ graves in the middle and lower Moselle area.

¹³⁹ I have used the latest version known to me: *Die Franken* 1996, 95. Unfortunately I have not been able to sort the graves into the chronological phases that I find relevant (4th century, late 4th first half 5th century). The majority, however, seem to belong to the 4th century.

¹⁴⁰ See Theuvs/Hiddink 1997 for the theory that this resettlement came from the south rather than the north and that it does not relate to Julianus’ activities in the north.

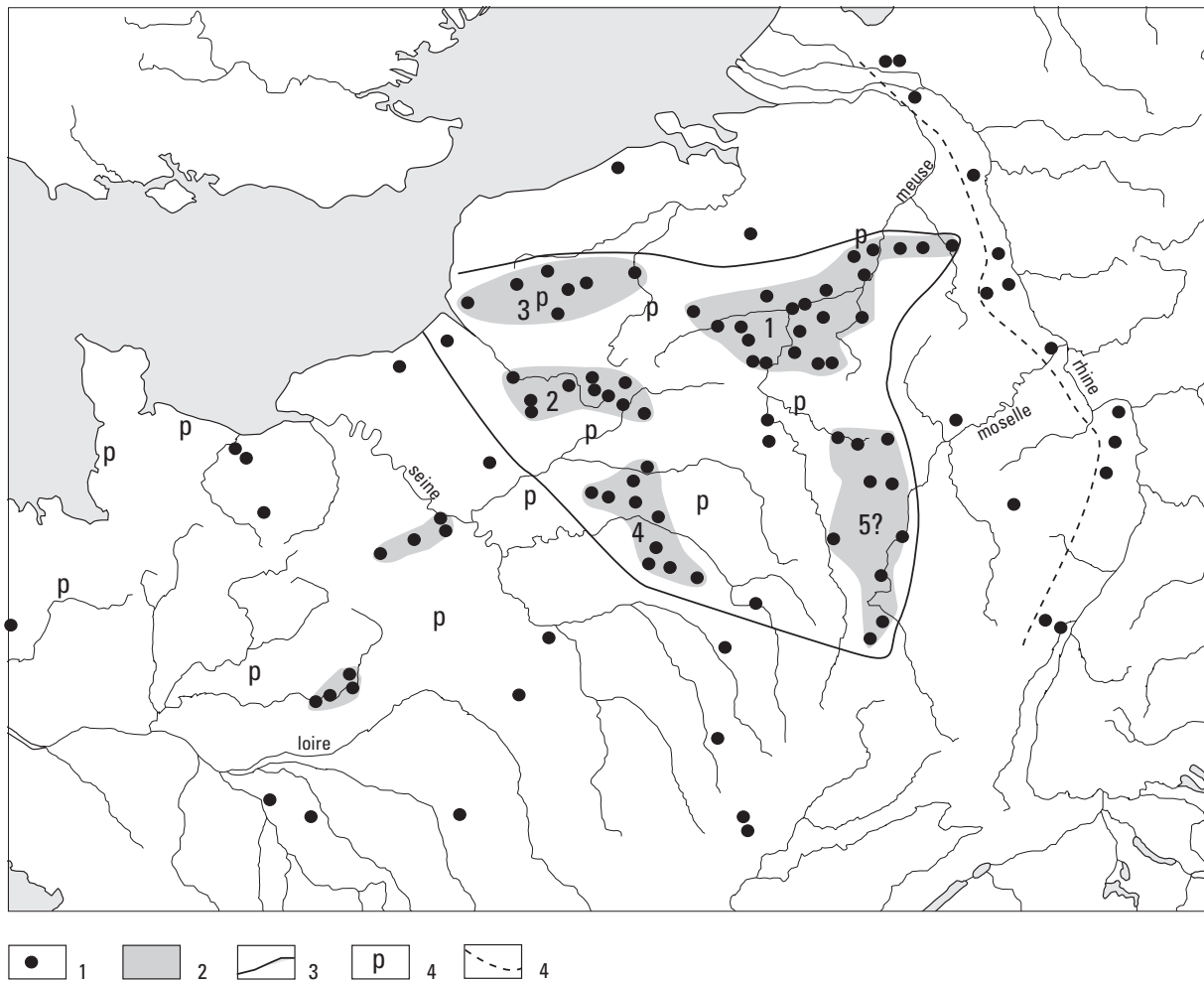

Fig. 8. The distribution of 'weapon' graves in northern Gaul. After Böhme 1974 and 1996.

1. Location with one or more 'weapon' graves; 2. areas with a concentration of 'weapon' graves; 3. line encircling areas with concentration of weapon graves; 4. seat of a *praefectus laetorum*.

What the map illustrates is that the distribution of 'weapon' graves is a phenomenon of the interior of Northern Gaul, far north of the river Seine. Another interesting fact is that the places where *praefecti laetorum* are supposed to have resided (even in the north) are almost all outside the areas with dense distributions.¹⁴¹ In my opinion, the distribution pattern of 'weapon' graves does not indicate where Germanic warriors settled; the distribution pattern is too specific. Nor does it show where local elites competed for power (why in specific regions and not in others?). There is another explanation that relates to the meaning of the burial rites as explained above. 'Weapon' graves are found in regions where large areas of *agri deserti* must have become available since the second half of the 3rd century. These were resettled under specific conditions in the 4th century, which led people to ritually define the new type of claims on the land. At that time, Northern Gaul was a patchwork ('peau de léopard') of settled and uninhabited areas where *villa* life continued to some extent. Habitation was certainly not as intense as it had been in

¹⁴¹ Böhner (1963) and Böhme (1974) have already established that the distribution of *praefecti laetorum* over

Northern Gaul does not match the main distribution area of the 'weapon' graves.

previous centuries, but we should discard the traditional notion that Northern Gaul was a totally abandoned landscape. According to Van Ossel and Ouzoulias, the abandonment of the luxurious residential quarters of estates does not necessarily mean that the agricultural production of the *villae* stopped; many *villae* show traces of occupation in the 4th century. They believe that agricultural production must have undergone a series of changes and certainly did not continue at the level of previous centuries.¹⁴²

A possible explanation for the ritual's specific symbolism may be that the resettlement associated with it took place outside the traditional bonds of loyalty between a *dominus* and his dependents and that new forms of settlement and claims on land developed outside the traditional villa system. These new forms of settlement may have developed in areas where traditional forms of land ownership were weak. The specific burial rite is rare in areas where there were fewer *agri deserti* available and where high-ranking *domini* still largely controlled the landscape, as may have been the case in regions south of the Seine and in the central and lower Moselle valley. Or perhaps forms of resettlement, associated with new types of claims on the land, did not occur where the military firmly controlled the region (along the shore, the Rhine and the immediate hinterlands)¹⁴³ and where other forms of resettlement (more group-like and under different land ownership conditions?) may have taken place (Toxandria?). In other words, the 'weapon' burials show us new types of landowners who were ritually defining their new types of claims on the soil.

Was this illegal? Probably not. Halsall tried to link the *Bacaudae* to this type of burial, but later corrected this interpretation. I will refrain from labelling these burials with the terms found in written texts such as *Bacaudae*, *laeti*, *foederati*, *dediticii*, Franci, Germani etc. In the case of the *Bacaudae*, it could very well be that in one region (the south) they were people trying to gain a kind of right to the soil denied them by the state and its representatives, rights that were granted to similar people by the same state in another region.¹⁴⁴

What about the graves with elaborate belts and crossbow brooches? Are they related to this phenomenon? Perhaps. Quite a few 'weapon' graves contained elaborate belts. But that does not suddenly transform the families involved from settlers into soldiers. Halsall hypothesised that, in their lavish display at the burial rite, local leading families were emulating the symbols of power reserved for state and military officials. Again, perhaps. It is also possible that those occupying deserted lands under new conditions

¹⁴² Van Ossel/Ouzoulias 2001.

¹⁴³ This zone shows a remarkable resemblance to a similar zone suggested by Drinkwater (1996, 29), for the sake of argument, as a more reasonable line of defence if the Germanic 'threats' at the Roman frontier were as serious as contemporary texts suggest. Drinkwater, however, questions the usefulness of the texts – because of their specific genres – for establishing whether the threats were in fact so grave. He sees the threats, as mentioned in the panegyrics for instance, as a textual construction; the texts overrate the strength of the Francs and Alamanni, and form part of a 'stage-show' for internal political use to strengthen the position of the western emperor by emphasising that he is in constant need of a strong army (and ditto taxes). The emperor had to be depicted as a successful general (also by showing his constant improvements of the defences): if everything was quiet on the northern front, which was more often the case than many a Roman military leader would have wished,

the aggression came from the Roman camp, not from the Germanic camp. Drinkwater explains that if we were to take the texts by Julianus and Ammianus Marcellinus as accurate representations of the geopolitical situation, it would mean that the Germanic people controlled a zone of about 130 miles wide inside the *limes*. However, I have already suggested that in the north of this zone at least a resettlement policy may have developed involving new settlers from the south and perhaps the north, which led to complex processes of identity creation (Theuws/Hiddink 1996, 79–80). The zone presented here on the map between the *limes* and the area with a denser distribution of weapon graves is about 100 miles wide. It may have been controlled by the army, rather than by Germanic groups, but there is no evidence to substantiate this.

¹⁴⁴ All kinds of rights might have been involved: social rights, tax reduction, etc, in which case the 'weapon' graves in the north were not those of *bacaudae*. On the *Bacaudae*, see Van Dam 1985, 25–56; Drinkwater 1992.

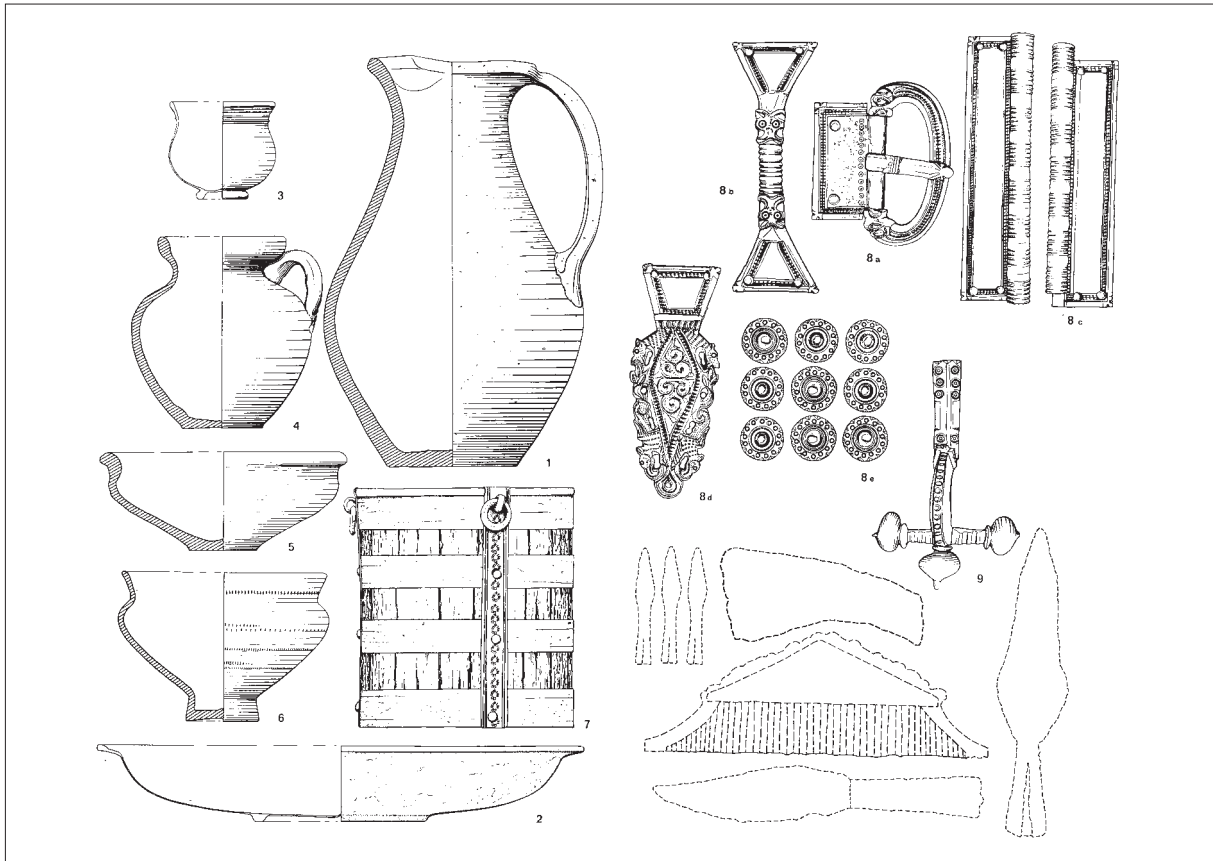

Fig. 9. Late Roman grave (nr 3) from Furfooz (province of Namur, Belgium) with elaborate belt (8), crossbow brooch (9), small bucket (beaker) (7), bronze bowl (2), glass cup (3), pottery (1, 4-6) and an axe, a lance, a comb, three arrowheads and a knife recorded in the 19th century, but now lost. After Dasnoy 1969.

(with the help of the state?) included quite a number of veterans. The presence of crossbow brooches in the north Gallic countryside could be explained along similar lines. Originally the crossbow brooch was a military sign or symbol. Swift has shown that most of the oldest specimens were found along the *limes*, but that later types penetrated into the Gallic interior.¹⁴⁵ This does not necessarily indicate a militarisation of the countryside (landlords turning into warlords, in the words of Whittaker), but may signal the occupation of lands by veterans under new conditions. Swift believes that, as crossbow brooches began to appear more inland than along the *limes*, their meaning changed: they became symbols of authority – not just of military officials but of civilian officials as well. This process runs parallel to the one described above for the late 4th and 5th centuries, when at least some of the ‘weapon’ burials signalled concepts different from those earlier in the 4th century. Significantly, however, as Böhme notes, crossbow brooches – a military marker par excellence – are absent from the graves of cemeteries associated with the hill fortresses in the central Meuse valley, with the exception of grave 3 at Furfooz (fig. 9).¹⁴⁶ If these cemeteries were those of soldiers one would expect crossbow brooches to be present in them. This mismatch in expected distribution patterns requires some attention, as there are others that may be relevant too. It is difficult to interpret the distribution patterns of elaborate belts and brooches because

¹⁴⁵ Swift 2000, 73–81, 230–233.

¹⁴⁶ Böhme 1985, 79. It is one of the most lavish axe burials.

the patterns presented are usually those of individual types.¹⁴⁷ The purpose of these maps is to locate production centres and their ‘market’. The maps do not lend themselves to analysing the distribution of depositions of elaborate belts and brooches, although it was deposition processes that initially determined their distribution patterns.¹⁴⁸ In order to understand these patterns we need quite different distribution maps that show the deposition of elaborate belts of all types in a certain period, as well as the contexts in which the objects were found. In the case of grave finds, these are the location within the grave, the grave’s location in the cemetery, the chronological position of the grave in the cemetery, the nature of the settlement, etc. Such maps are not yet available. From the maps to hand, we observe, at a very general level, that the distribution of elaborate belts to some extent matches that of ‘weapon’ graves, but that there are also marked differences. For instance, some types are regularly found in the Trier area, where others are rare or absent.¹⁴⁹ This mismatch is a signal that the deposition of elaborate belts and brooches and those of ‘weapons’ may have a similar background. The same goes for ‘Germanic’ women’s graves. Halsall has already alerted us to the discrepancy in the distribution of ‘Germanic’ men’s and women’s graves.¹⁵⁰ Traditional research has thrown them all onto one big heap, that of ‘Germanic’ graves. The question we must ask ourselves, however, taking into account more sophisticated gender approaches, different perception schemes and the analysis of different discourses, is what different rhetorical strategies lay behind the different deposition rites? Women may have been buried with jewellery for quite different reasons than men with ‘weapons’.

Were the men who were buried with axes, lances, bow and arrows in the 4th and 5th centuries local leaders of families competing for local power, with the lavish burial as an important strategy? Some may have been; most of them were probably not – first of all, because the rhetoric of the burial ritual was not about social competition, and second, because the objects in the majority of the axe, lance and bow and arrow graves are not of exceptional quality. The large belts, like the majority of crossbow brooches, may have been mass-produced for the army.¹⁵¹ Axes, lances, bows and arrows would have been widely dispersed in society, either as agricultural implements or for hunting. The pottery or glass beakers found in graves would have been quite common.¹⁵² There seems to be no monumentalisation of these graves. I cannot imagine that the families who created these graves belonged to the elite. Some perhaps, but not the majority. Instead, they were families who occupied a special position vis-à-vis the traditional social relations and structures of land ownership in the countryside. They may have led small communities, but I do not believe that they determined events in the countryside. In some cases, however, their position may have changed at the end of the 4th century.

Finally, what I find hardest to explain is the small number of burials. This could always be due to the find circumstances and the current state of research. The small number of ‘weapon’ graves could also result

¹⁴⁷ Swift 2000.

¹⁴⁸ See also Härke 1991. Too often distribution maps of this type are thought to represent the circulation of objects, which is a methodological mistake. They represent their deposition; circulation and deposition have different backgrounds.

¹⁴⁹ Present are belts of ‘Sorte 1 Form C type B’ (entire 4th century, Swift 2000, 193, fig. 234) and the chip carved belts ‘Sorte 1 Form E (later 4th century, Swift 2000, 200, fig 246). Barely present are late chip carved belts (Böhme 1972, map 12) and simple belts (Böhme 1972, map 13). I find it difficult to correlate the typologies and distribution maps of different authors. What we need now is

distribution maps of *complete* belts, not of different parts such as the ‘lancet-shaped strap end’ or ‘propeller fittings’ etc.

¹⁵⁰ Halsall 1992.

¹⁵¹ That is type 3/4 brooches that make up the bulk of the finds. Later crossbow brooches are sometimes of gold or silver, Swift 2000.

¹⁵² In the settlement at Gennep, where there was an intensive sieving programme during excavation, hundreds of fragments of glass beakers demonstrate that the types of beakers found in the cemeteries were a common element in rural settlements (Heidinga/Offenberg/Koelman 1992, 99-101).

from the limited geographical areas in which these graves have been found in sufficient numbers. Another possibility is that only a small number of families buried one of their members as a way of expressing their claims to the soil. In that case, they may have found it necessary to create a protecting ancestor and a 'lieu de mémoire', where others did without or were unable to substantiate the claim. For that reason, references to the hunt could be even more important than I have suggested above. If the hunt also referred to overcoming death and the completion of life, this could be linked to the desire to create an ancestor to perpetuate the family's claims. In addition to conceptualising new claims, performing such a burial rite may have had something to do with defining hereditary rights to property that may not have existed in that form for the social groups involved. This explanation differs from Halsall's in that it does not refer to the stresses and crises surrounding the 'normal' intergenerational transfer of land and power when it came to competition between groups.¹⁵³ The burial ritual created an ancestor for a family, with various connotations depending on the type of burial and ancestor required. The burial rite and the resulting grave are, like the Lives of Saints, 'sacred fictions'.

7 CONCLUSION

In the end, I come back to the theme of the conference: material culture, power and ethnic identity. The study of late Roman burial rites is an arena well known for its ethnic identity research. New elements in the burial rites of Northern Gaul in the 4th century were invariably interpreted as either the result of the movement of ethnic groups into the region or, if the new rites were not present in the supposed region of origin, as a local elaboration of rites by foreign groups to define their ethnic identity. A fundamental question should be asked: why would ethnic identity be an important element in the burial ritual at all? Related to this basic issue are a number of other questions to which, however, there are no direct answers. If ethnic identity were an identity defining overarching groups in society, why would this identity pre-

¹⁵³ My interpretation could well be one of the elements of the rhetorics of Childeric's grave. Clovis had several problems with regard to the definition of what constitutes Frankish leadership/kingship. The intergenerational transfer of power was one of them, as Halsall (2001) rightly states, but not as a commonly recurring problem confronting all aristocratic families at death, in the competition for power between aristocratic groups, or in his case in the specific political evenemential context of his days. The problem was more structural and conceptual. Halsall may well be right in his supposition that the Roman army identified itself as Frankish over the course of time. Clovis' attempt to make the generalship of the Roman army an overtly hereditary position, and thereby ruling out a leadership selection, may not have been automatically accepted (neither by his adversaries nor his friends). Childeric's burial ritual might have helped to establish such a foundation for Merovingian leadership- turned-kingship as it helped to unite various groups. The burial was thus intended to create an apical ancestor who could provide protection

(hence the weapons in the grave), who was anchored in the landscape, and whose monumental grave could become a 'lieu de mémoire' (did Childeric's 'grave' really contain his body?). This seems to be the meaning of the 'founder's grave'. In my opinion, Childeric's grave – like other male founders' graves – should be interpreted first and foremost as the creation of ancestors who could protect, substantiate claims and create hereditary positions, which is why large amounts of weaponry were deposited in these graves. We need not be surprised that women were buried in founders' graves. They may have been associated with fertility and continuity as well as hereditary positions; for some families, it may have been more important to create ancestors associated with these qualities than with male ancestors. Not many cemeteries have yielded founder-like graves in the generations that date from a later period. In my opinion, this was not because social competition ceased, but because – as long as no new groups presented claims – new ancestors were not needed.

vail in the burial rite over other (local and social) identities? Was the nature of specific ethnic identities communicated over large areas with such clarity that it became as invariable as traditional scholarship supposes? Was ethnic identity always such an issue for the villagers of Northern Gaul that they buried their dead accordingly? Or to put it more directly, why would women and men in villages scattered over Northern Gaul bury their kin according to ethnic identities as described in the texts of authors nearby and far away? Traditional scholarship dealing with burial rites may have placed such emphasis on ethnic interpretations because some Late Antique authors did so for political or other reasons. But they may well have had their own agenda, just as the villagers probably did. In section 3 I have tried to explain that the idea of ethnic identity as expressed in texts does not necessarily relate to social and ritual practices. What we know of ethnic identity in Late Antique Gaul is mainly based on textual constructions of identity. Was this identity widely shared on a day-to-day basis? Again, was it relevant in the burial rites of the majority of the population? The last two questions may be answered differently. Even if ethnic identity as we know it from textual constructions was widely shared (and I doubt that it was), I do not believe that it was a major issue in the burial rites in Northern Gaul in the 4th and 5th centuries. The burial rites may have been an arena for much more elaborate rhetorical strategies to communicate other aspects of 'being in the world', such as the presentation of new types of claims on the soil, outside the traditional bonds of the Roman villa system. The 'weapon graves' are possibly those of new ancestors that in some instances – but not all – underline those claims. As is usually the case, new interpretations engender new questions. I have tried to emphasise the fact that the burial rites of Northern Gaul in late Roman times are as rich a source for the study of norms, values and ideas as those of other societies subjected to anthropological study and that to interpret them as representing primarily ethnic identities is too one-dimensional.

REFERENCES

- Ament, H., 1978: Romanen an Rhein und Mosel im frühen Mittelalter, *Archäologische Bemühungen um ihren Nachweis*, *Bonner Jahrbücher* 192, 261–271.
- Amory, P., 1997: *People and identity in Ostrogothic Italy*, Cambridge.
- Andreae, B., *Die Sarkophage mit Darstellungen aus dem menschlichen Leben 2. Die römischen Jagdsarkophage*, Berlin.
- Barth, F., 1969: *Ethnic groups and boundaries. The social organization of cultural difference*, Boston.
- Barth, F., 1992: Towards greater naturalism in conceptualising societies, in A. Kuper (ed.), *Conceptualizing society*, London/New York, 17–33.
- Bazelmans, J., 1999: *By Weapons made worthy. Lords, retainers and their relationship in Beowulf*, Amsterdam (Amsterdam archaeological studies 5).
- Bazelmans, J., 2002: Moralities of dress and the dress of the dead in Early medieval Europe, in Y. Hamilakis/M. Pluciennik/S. Tarlow (eds), *Thinking through the body. Archaeologies of corporeality*, New York etc., 71–84.
- Böhme, H.W., 1974: *Germanische Grabfunde des 4. und 5. Jahrhunderts zwischen unterer Elbe und Loire. Studien zur Chronologie und Bevölkerungsgeschichte*, München.
- Böhme, H.W., 1985: Les découvertes du Bas-empire à Vireux-Molhain considérations générales, in J.-P. Lemant, *Le cimetière et la fortification du Bas-empire de Vireux-Molhain, Dep. Ardennes* (avec les contributions de H.W. Böhme, D. Bayard et J.-M. Doyen), Mainz (Römisch–Germanisches Zentralmuseum, Monographien 7), 76–88.
- Böhme, H.W., 1996: Söldner und Siedler in spätantiken Nordgallien, in *Die Franken Wegbereiter Europas. Vor 1500 Jahren: König Chlodwig und seine Erben*, Mainz, 91–101.
- Böhner, K., 1963: Zur historischen Interpretation der sogenannten Laetengräber, *Jahrbuch des Römisch-Germanischen Zentralmuseums* 10, 139–167.

- Brather, S. 2002: Ethnic identities as constructions of archaeology. The case of the Alamanni, in A. Gillet (ed.), *On barbarian identity. Critical approaches to ethnicity in the Early Middle Ages*, Turnhout (Studies in Early Middle Ages 4), 149-175.
- Brown, P.R.L., 1980: Art and society in Late Antiquity, in K. Weitzmann (ed.), *Age of spirituality. A symposium*, New York/Princeton, 17-27.
- Brulet, R., 1990: *La Gaule septentrionale au Bas-Empire. Occupation du sol et défense du territoire dans l'arrière-pays du Limes aux IVe et Ve siècles*, Trier (Trierer Zeitschrift für Geschichte und Kunst der Trierer Landes und seiner Nachbargebiete, Beiheft 11).
- Bullinger, H., 1969: *Spätantike Gürtelbeschlüge. Typen, Herstellung, Tragweise und Datierung*, Brugge.
- Coon, L., 1997: *Sacred Fictions. Holy women and hagiography in Late Antiquity*, Philadelphia.
- Dasnoy, A., 1969: La nécropole de Furfooz. Revision des notes et documents anciens, *Annales de la Société Archéologique de Namur* 55, 121-194.
- Dasnoy, A., 1988: Incinérations funéraires des IVe et Ve siècles dans la région namuroise, *Annales de la Société Archéologique de Namur* 65, 391-406.
- Drinkwater, J.F., 1992: The Bacaudae of fifth-century Gaul, in Drinkwater, J./H. Elton (eds), *Fifth-century Gaul: a crisis of identity?*, Cambridge, 208-217.
- Drinkwater, J./H. Elton (eds), 1992: *Fifth-century Gaul: a crisis of identity?*, Cambridge.
- Drinkwater, J.F., 1996: 'The Germanic threat on the Rhine frontier': a Romano-Gallic artefact?, in R.W. Mathisen/H.S. Sivan (eds), *Shifting frontiers in Late Antiquity*, Aldershot, 20-30.
- Dunbabin, K.M.D., 1999: *Mosaics of the Greek and Roman world*, Cambridge.
- Effros, B., 1996: Symbolic expressions of sanctity: Gertude of Nivelles in the context of Merovingian mortuary custom, *Viator* 27, 1-10.
- Effros, B., 2003: *Merovingian mortuary archaeology and the making of the Early Middle Ages*, Berkeley/Los Angeles/London.
- Die Franken Wegbereiter Europas. Vor 1500 Jahren: König Chlodwig und seine Erben*, Mainz.
- Friedhof, U., 1991: *Der römische Friedhof an der Jakobstrasse zu Köln*, Mainz (Kölner Forschungen 3).
- Gasparri, S., 2000: Kingship rituals and ideology in Lombard Italy, in F. Theuvs/J. Nelson (eds), *Rituals of power. From Late Antiquity to the Early Middle Ages*, Leiden/Boston/Köln (Transformation of the Roman World 8), 95-114.
- Geary, P., 1983: Ethnicity as a situational construct in the Early Middle Ages, *Mitteilungen der anthropologischen Gesellschaft in Wien* 113, 15-26.
- Geary, P., 2002: *The myth of nations. The medieval origins of Europe*, Princeton/Oxford.
- Gerberding, R., 1987: *The rise of the Carolingians and the Liber Historiae Francorum*, Oxford.
- Gillet, A. (ed.), 2002: *On barbarian identity. Critical approaches to ethnicity in the Early Middle Ages*, Turnhout (Studies in Early Middle Ages 4).
- Goffart, W., 1988: *The narrators of barbarian history (A.D. 550-800). Jordanes, Gregory of Tours, Bede and Paul the Deacon*, Princeton.
- Groot, H.L. de, 1993: *Traces at Traiectum. An archaeological survey*, Utrecht.
- Hadley, D./J.M. Moore, 1999: 'Death makes the man'? Burial rite and the construction of masculinities in the Early Middle ages, in D.M. Hadley (ed.), *Masculinity in medieval Europe*, London/New York, 21-38.
- Halsall, G., 1992: The origins of the *Reihengräberzivilisation*: forty years on, in J. Drinkwater/H. Elton (eds), *Fifth-century Gaul: a crisis of identity?*, Cambridge, 196- 207.
- Halsall, G., 1995: *Settlement and social organization. The Merovingian region of Metz*, Cambridge.
- Halsall, G., 1996: Female status and power in early Merovingian central Austrasia: the burial evidence, *Early Medieval Europe* 5, 1-24.
- Halsall, G., 2000: Archaeology and the Late Roman frontier in Northern Gaul: the so-called "Föderatengräber" reconsidered, in W. Pohl/H. Reimitz (eds), *Grenze und Differenz im frühen Mittelalter*,

- Wien (Forschungen zur Geschichte des Mittelalters 1, Österreichische Akademie der Wissenschaften, Philologisch-Historische Klasse Denkschriften 287), 167-180.
- Halsall, G., 2001: Childeric's grave, Clovis' succession, and the origins of the Merovingian kingdom, in R.W. Mathisen/D. Shanzer (eds), *Society and culture in Late Antique Gaul. Revisiting the sources*, Aldershot, 116-133.
- Härke, H., 1990: 'Warrior graves'? The background of the Anglo-Saxon weapon burial rite, *Past and Present* 126, 22-43.
- Härke, H., 1991: All quiet on the western Front? Paradigms, methods and approaches in West German archaeology, in I. Hodder, (ed.), *Archaeological Theory in Europe. The last three decades*, London, 187-222.
- Härke, H., 1992: *Angelsächsische Waffengräber des 5. bis 7. Jahrhunderts* (Zeitschrift für Archäologie des Mittelalters, Beiheft 6), Köln/Bonn.
- Härke, H., 2000: Social analysis of mortuary evidence in German protohistoric archaeology, *Journal of Anthropological Archaeology* 19, 369-384.
- Haupt, D., 1973: Spät Römisches Grab mit Waffenbeigabe aus Bonn, in W.A. van Es, et al. (eds), *Archeologie en Historie. Opgedragen aan H. Brunsting bij zijn zeventigste verjaardag*, Bussum, 315-326.
- Heidinga, H.A./G.A.M. Offenbergh/A.Koelman, 1992: *Op zoek naar de vijfde eeuw. De Franken tussen Rijn en Maas*, Amsterdam.
- Henning, J., 1985: Zur Datierung von Werkzeug- und Agrargerätenfunden im Germanischen Landnahmegebiet zwischen Rhein und Oberer Donau (Der Hortfund von Osterburken), *Jahrbuch des Römisch-Germanischen Zentralmuseums Mainz* 32, 570-594.
- Huntingdon, R./P. Metcalf, 1979: *Celebrations of death. The anthropology of mortuary ritual*, Cambridge.
- Jobst, W./B. Erdal/Chr. Gurtner, 1997: *Istanbul. Das grosse Byzantinische Palastmosaik. Seine Erforschung, Konservierung und Präsentation 1983-1997*, Istanbul.
- Johnson, M., 2001⁵: *Archaeological theory. An introduction*, Oxford.
- Kent, J.P.C./K.S. Painter, 1977: *Wealth of the Roman world AD 300-700*, London.
- Koch, A., 1998: *Bügel fibeln der Merowingerzeit im westlichen Frankenreich*, Mainz (Römisch-Germanisches Zentralmuseum, Monographien 41).
- Kopytoff, I., 1986: The cultural biography of things: commoditisation as a process, in A. Appadurai (ed.), *The social life of things. Commodities in cultural perspective*, Cambridge, 64-91.
- Lemant, J.-P., 1985: *Le cimetière et la fortification du Bas-empire de Vireux-Molhain, Dep. Ardennes* (avec les contributions de H.W. Böhme, D. Bayard et J.-M. Doyen), Mainz (Römisch-Germanisches Zentralmuseum, Monographien 7).
- Maas, M., 1992: Ethnicity, orthodoxy and community in Salvian of Marseilles, in J. Drinkwater/H. Elton (eds), *Fifth-century Gaul: a crisis of identity?*, Cambridge, 275-284.
- Murray, A.C., (ed.), 1998: *After Rome's Fall. Narrators and sources of Early Medieval History. Essays presented to Walter Goffart*, Toronto/Buffalo/London.
- Päffgen, B., 1992: *Die Ausgrabungen in St. Severin zu Köln* (3 vols), Mainz (Kölner Forschungen 5).
- Panhuysen, T.A.S.M., 1996: *Romeins Maastricht en zijn beelden*, Maastricht/Assen (Corpus Signorum Imperii Romani, Nederland, Germania Inferior, Maastricht).
- Pastoureau, M., 1993: *L'arbre. Histoire naturelle et symbolique de l'arbre, du bois et du fruit au Moyen Age*, Paris.
- Paxton, F.S., 1990: *Christianizing Death. The creation of a ritual process in early medieval Europe*, Ithaca/London.
- Périn, P., 1981a: L'assimilation ethnique vue par l'archéologie, *Dossiers de l'archéologie* 56, 38-47.
- Périn, P. 1981b: A propos de publications récentes concernant le peuplement en Gaule à l'époque mérovingienne: la 'question franque', *Archéologie Médiévale* 11, 125-145.
- Périn, P./L.-Ch. Feffer, 2001³: *Les Francs. I A la conquête de la Gaule. II A l'origine de la France*, Paris.
- Perse, M., 1991: Hirschjagdschale, in J. Engemann/Chr. B. Rüger (eds), *Spätantike und frühes Mittelalter. Ausgewählte Denkmäler im Rheinischen Landesmuseum Bonn*, Köln/Bonn, 269-274.

- Pirling, R., 1966: *Das Römisch-Frankische Gräberfeld von Krefeld-Gellep 1960-1963*, Berlin (Germanische Denkmäler der Völkerwanderungszeit B 10).
- Pirling, R., 1993: Römische Gräber mit barbarischem Einschlag auf den Gräberfeldern von Krefeld-Gellep, in F. Vallet/M. Kasanski (eds), *L'armée Romaine et les barbares du IIIe au VIIe siècle*, Paris, 109-123.
- Pirling, R., 1975: Die Gräberfelder von Krefeld-Gellep. Romanen und Franken im Rheinland, in *Ausgrabungen in Deutschland gefördert von der Deutschen Forschungsgemeinschaft 1950-1975, Band 2, Römische Kaiserzeit im freien Germanien. Frühmittelalter 1*, Mainz, 165-180.
- Plumier, J., 1986: *Tumuli Belgo-Romains de la Hesbaye occidentale: Séron, Hanret, Bois de Buis, Penteville, Namur*.
- Pohl, E., 1991: Sarkophaggrab aus Bonn (Jakobstrasse), in J. Engemann/Chr. B. Rieger (eds), *Spätantike und frühes Mittelalter. Ausgewählte Denkmäler im Rheinischen Landesmuseum Bonn*, Köln/Bonn, 29-34.
- Pohl, W./H. Reimitz, (eds), 1998: *Strategies of Distinction. The construction of ethnic communities, 300-800*, Leiden/Boston/Köln (Transformation of the Roman World 2).
- Pohl, W., 1998: Telling the difference: signs of ethnic identity, in W. Pohl/H. Reimitz (eds), 1998: *Strategies of Distinction. The construction of ethnic communities, 300-800* Leiden/Boston/Köln (Transformation of the Roman World 2), 17-69.
- Pohl, W., 2000: *Die Germanen*, München (Enzyklopädie deutscher Geschichte 57).
- Pohl, W., 2002: Ethnicity, Theory, and Tradition. A response, in A. Gillet (ed.), *On barbarian identity. Critical approaches to ethnicity in the Early Middle Ages*, Turnhout (Studies in Early Middle Ages 4), 221-239.
- Reynolds, S., 1998: Our Forefathers? Tribes, peoples, and nations in the historiography of the Age of Migrations, in A.C. Murray, (ed.), *After Rome's fall. Narrators and sources of Early Medieval history. Essays presented to Walter Goffart*, Toronto/Buffalo/London, 17-36.
- Riedel, M., 1998: Frühe römische Gräber in Köln, in P. Fasold et al. (eds), 1998: *Bestattungssitte und kulturelle Identität. Grabanlagen und Grabbeigaben der frühen römischen Kaiserzeit in Italien und den Nordwest-Provinzen. Kolloquium in Xanten vom 16. bis 18.2.1995*, Bonn (Xantener Berichte 7), 307-318.
- Samson, R., 1987: Social structures from *Reihengräber*: mirror or mirage?, *Scottish Archaeological Review* 4, 116-126.
- Schiek, S., 1992: *Das Gräberfeld der Merowingerzeit bei Oberflacht*, Stuttgart (Forschungen und Berichte zur Vor- und Frühgeschichte in Baden-Württemberg 41).
- Schoen, R.P., 2000: *Pro facultatibus vel dignitate defuncti. Uitvaartritueel, sociale status en regelgeving in Rome (100 v. Chr.-300 n. Chr.)*, Zutphen.
- Scholkmann, B., 1997: Die frühen Kirchen, in *Die Alamannen*, Stuttgart, 455-464.
- Schulze-Dörlamm, M., 1985: Germanische Kriegergräber mit Schwertbeigabe in Mitteleuropa aus dem späten 3. Jahrhundert und der ersten Hälfte des 4. Jahrhunderts nach Chr. Zur Entstehung der Waffenbeigabensitte in Gallien, *Jahrbuch des Römisch-Germanischen Zentralmuseums Mainz* 32, 509-569.
- Seiller, C., 1992: Les tombes de transition du cimetière germanique de Vron (Somme), *Jahrbuch des Römisch-Germanischen Zentralmuseums Mainz* 36,2, 599-634.
- Stein, F., 1974: Franken und Romanen in Lothringen, in G. Kossack/G. Ulbert (eds), *Studien zur vor- und frühgeschichtlichen Archäologie. Festschrift für Joachim Werner zum 65. Geburtstag*, München, 579-589.
- Spätantike und frühes Christentum*, 1984, Frankfurt am Main.
- Swift, E., 2000: *Regionality in dress accessories in the Late Roman West*, Montagnac (Monographies instrumentum 11).
- Theune-Grosskopf, B., 1997: Der lange Weg zum Kirchhof. Wandel der germanischen Bestattungstradition, in *Die Alamannen*, Stuttgart, 471-480.
- Theuvs, F./H. Hiddink, 1996: Der Kontakt zu Rom, in *Die Franken Wegbereiter Europas. Vor 1500 Jahren: König Chlodwig und seine Erben*, Mainz, 66-80.
- Theuvs, F., 1999: Changing Settlement Patterns, burial grounds and the symbolic construction of ancestors and communities in the late Merovingian Southern Netherlands, in Ch. Fabech/J. Ringtved (eds), *Set-*

- tlement and landscape. *Proceedings of a conference in Århus, Denmark may 4-7 1998*, Hojbjerg, 337-349.
- Theuws, F., 2000: Introduction. Rituals in transforming societies, in F. Theuws/J. Nelson (eds), *Rituals of power. From Late Antiquity to the Early Middle Ages*, Leiden/Boston/Köln (Transformation of the Roman World 8), 1-13.
- Theuws, F./M. Alkemade, 2000: A kind of mirror for men. Sword depositions in Late Antique northern Gaul, in F. Theuws/J. Nelson (eds), *Rituals of power. From Late Antiquity to the Early Middle Ages*, Leiden/Boston/Köln (Transformation of the Roman World 8), 401-476.
- Theuws, F./J. Nelson, (eds), 2000: *Rituals of power. From Late Antiquity to the Early Middle Ages*, Leiden/Boston/Köln (Transformation of the Roman World 8).
- Theuws, F., 2001: Review: Frank Siegmund, Merowingerzeit am Niederrhein, *Germania* 79, 194-199.
- Toynbee, J.M.C., 1996² (1971): *Death and burial in the Roman world*, Baltimore (London).
- Treherne, P., 1995: The warrior's beauty: the masculine body and self identity in Bronze-age Europe, *Journal of European Archaeology* 3, 105-144.
- Van Dam, R., 1985: *Leadership and community in late antique Gaul*, Berkeley/Los Angeles/Oxford.
- Van Es, W.A., 1968: *Grafritueel en kerstening*, Bussum.
- Van Es, W.A./A. Wagner, 2000: Vijfde eeuw op de Donderberg. Begraven in Rhenen tussen Romeinen en Franken, in D. Kicken/A.M. Koldewey/J.R. ter Molen (eds), *Gevonden voorwerpen. Lost and Found. Opstellen over middeleeuwse archeologie voor H.J.E. van Beuningen*, Rotterdam (Rotterdam Papers 11), 116-129.
- Van Ossel, P./P. Ouzoulias, 2001: La mutation des campagnes de la Gaule du Nord entre le milieu du IIIe siècle et le milieu du Ve siècle. Où en est-t-on?, in M. Lodewijckx (ed.), *Belgian Archaeology in a European setting II*, Leuven, 231-245.
- Vanvinckenroye, W., 1984: *De Romeinse zuidwest-begraafplaats van Tongeren (opgravingen 1972-1981)*, Tongeren.
- Werner, J., 1950: Zur Entstehung der Reihengräberzivilisation, *Archaeologia Geographica* 1, 23-32.
- Willems, W.J.H., 1984: Romans and Batavians. A regional study in the Dutch Eastern River Area, II, *Berichten van de Rijksdienst voor het Oudheidkundig Bodemonderzoek* 34, 39-331.
- Whittaker, C.R., 1994: *Frontiers of the Roman empire. A social and economic study*, Baltimore/London.
- Wood, I., 1997: Report: The European Science Foundation's Programme on the Transformation of the Roman World and the emergence of Early Medieval Europe, *Early Medieval Europe* 6, 217-227.
- Young, B., 1977: Paganisme, christianisation et rites funéraires mérovingiens, *Archéologie Médiévale* 7, 5-81.
- Young, B., 1980: Le problème franc et l'apport des pratiques funéraires (IIIe-Ve siècles), *Bulletin de liaison AFAM* 2, 4-18.
- Ypey, J., 1973: Das fränkische Gräberfeld zu Rhenen, Prov. Utrecht, *Berichten van de Rijksdienst voor het Oudheidkundig Bodemonderzoek* 23, 289-312.

The early-medieval use of ethnic names from classical antiquity. The case of the Frisians

Jos Bazelmans

- 1 Introduction
- 2 A late-Roman population hiatus in the Netherlands coastal region?
- 3 The survival of the Frisian name
- 4 Summary and conclusion

Classical and early-medieval sources

References

I INTRODUCTION

We first encounter the names of most northwest European early-medieval tribes in literary and epigraphical sources from the 3rd or 4th centuries. This is generally thought to be linked to the collective ethnogenesis that had its roots in the large-scale migrations that began in this period.¹ These migrations are believed to have made deep inroads into the old tribal order, leading to a fundamental transformation of the original ethnic geography of *Germania magna*. The Frisians are an exception, however: they are one of the few early-medieval tribes whose name we know from 1st- and 2nd-century sources.² The obvious explanation for this exceptional continuity would be to assume that the early-medieval inhabitants of the North and West Netherlands coastal region were the direct descendants of their older namesakes and that successive generations of people living there had continued to call themselves Frisians. If so, Frisian ethnogenesis would not be a phenomenon of the Migration period, but of prehistory.³

However, since the beginning of the 20th century some scholars have raised doubts as to whether the Frisian tribe did in fact survive undisturbed for over two millennia. In 1906 the archaeologist Pieter Boeles first put forward the notion of a far-reaching Anglo-Saxon invasion of the Frisian area from the east, in the eventful years between the Roman period and the early Middle Ages.⁴ According to Boeles, large numbers of Anglo-Saxons conquered the Frisian area in the 5th century and subdued the Frisians; the new Anglo-Frisian conglomerate, however, continued to be known under the old Frisian name. Although Boeles' thesis found few adherents during the 20th century, recent archaeological, toponymic and linguistic research has given his ideas new impetus. There is strong evidence of complete or near complete depopulation in the North Netherlands coastal region in the 4th century, with colonists from the east encountering nobody – or almost nobody – there in the early 5th century. But how then can

¹ Cf. Wenskus 1977 (1961).

² E.g. Ptolemaeus, *Geogr.* 2,11,7; Tacitus, *Germ.* 34; Dio, *Hist.* 54, 32, 2-2.

³ According, for example, to Halbertsma 2000 (1982), 20-23.

⁴ Boeles 1906. See also Boeles' 1951 *magnum opus*.

we explain the continued use of the name Frisians if the original inhabitants either underwent profound social and demographic changes – which would certainly have affected their ethnic self-definition – or disappeared altogether? In this contribution, I shall investigate two alternative possibilities that could explain the survival of the Frisian name. The first is that the new inhabitants named themselves after the almost empty area they colonised or after the former or residual inhabitants of the colonised area.⁵ The second is that the Franks, outsiders who were familiar with the classical ethnographic tradition, reintroduced the name in the 6th and 7th centuries to designate the new ethnic amalgamation that had emerged in the Netherlands coastal region in the Migration period.

Ethnicity research has undergone a fundamental change in perspective in past decades in the fields of anthropology, archaeology and early-medieval historiography. Although this is not the place to discuss these changes,⁶ for a proper understanding of the position adopted in this article, I would like to emphasise that the cultivation and codification of myths, stories, genealogies, rituals and law always play a key role in ethnogenetic processes. It is often difficult or impossible to determine whether these ‘new’ traditions, which make no distinction between myth and history, have preserved the facts about the origin and history of the group. Not that this should be the purpose of research. It is more important to understand how a tradition derived its authenticity and credibility for a broader public from the way in which it was handed down in symbolic, oral or written form. For a proper understanding of early medieval sources for example, we need to place them in a complex intertextual matrix, which includes Greek and Roman ethnographic works.⁷ In early-medieval sources, ethnic names are more than descriptive categories; they also evoke complex associations that are deeply rooted in the literary past. By mentioning certain ‘canonical’ names, authors could show off their knowledge or add weight to the actions of prominent people.⁸ And names of groups that played a key role in the author’s time could retrospectively gain a place in tribal histories.

With these considerations in mind, I intend below to focus once again on the Roman/early-medieval continuity of the Frisian name. Doubts about the most obvious explanation – that continuity of name implies ethnic continuity – have been prompted by the growing body of evidence of profound changes in the Netherlands coastal region in the late-Roman and Migration periods.

2 A LATE-ROMAN POPULATION HIATUS IN THE NETHERLANDS COASTAL REGION?

Russchen’s *New light on dark age Frisia* from 1967 is to date the best, most comprehensive rebuttal of Boeles’ thesis that the Frisians were the victim of a large-scale, destructive Anglo-Saxon invasion in late-Roman times.⁹ Nevertheless, new research compelled Russchen to modify his case for continued habitation in the North Netherlands coastal region: the physical anthropologist Huizinga had discovered an interruption in skull shape development in North Netherlands populations between Roman and early-medieval times; the onomastician Gysseling had demonstrated that place names in the Frisian-Groningen region did not predate the Migration period; and the archaeologist Halbertsma had pointed to the possibility of a late-Roman population hiatus in the *terp* area.¹⁰ By adding linguistic research, we

⁵ Cf. Gerrets 1999.

⁶ See the introduction to this volume.

⁷ Research should shed light on the nature and strength of the relationship between specific texts. Cf. Wolfram 1994.

⁸ Cf. Heather 1998.

⁹ See also Russchen 1970.

¹⁰ Huizinga 1954 and 1955; Gysseling 1965; Halbertsma 1958 and 1959. Little value is attached to Huizinga’s work nowadays. Also important for the discussion of place-name material is the work of Kuhn, who was much more outspoken than Gysseling (Kuhn 1966). On the basis of a study of North Netherlands toponyms, he spoke of a complete rehabilitation of Boeles’ thesis.

can use this tripartite division in the field of study to review research findings since 1967. My focus will not be the coastal region of the North Netherlands alone, but the West as well. After all, the Roman/early-medieval continuation of the Frisian name might also go back to continuity of habitation outside what is traditionally regarded as the Frisian heartland (i.e. Westergo and Oostergo or the North Netherlands coastal region), namely in North and South Holland – according to classical sources the territory of the *Frisii* (or *Frisii minores*) and the *Frisiavones*.¹¹

We can be brief about physical-anthropological research in the Netherlands coastal region since Huizinga: there is almost none to speak of.¹² Without adding new material, and influenced by the criticism of Boeles' thesis, Constandse-Westermann modified Huizinga's pronouncements in the late 1960s and concluded that 'without too complicated an explanation, the skulls of the *terp* Frisians and Groningers [...] [can] be linked to the present-day population of these provinces'. She argued, however, that synchronous and diachronous variation in skull shape did not rule out the possibility of 'one or several waves of invasions or a gradual infiltration from the east or south-east by new tribes'.¹³

The study of place-name material offers more clues when it comes to making assertions about continuity or discontinuity of habitation in the West and North Netherlands coastal region. The very small number of archaic (i.e. pre-medieval) place and river names in North and South Holland is generally interpreted as proof of continuity of habitation on a modest scale on the Netherlands barrier beaches in the late-Roman period and early Middle Ages and of continued use during that time of the watercourses in the peat area behind the barrier beaches.¹⁴ However, the situation is very different in the North Netherlands coastal region. Whereas pre-medieval place and river names are very rare in Groningen, they appear to be absent altogether in Westergo, Oostergo and East Friesland.¹⁵ Because we can also demonstrate that early-medieval place names of the North Netherlands area are not of a great age and that there was no artificial fashioning of pre-medieval names into new, medieval ones, we can almost certainly interpret the virtual absence of archaic place names in terms of either a population hiatus or habitation on a very small scale.¹⁶ The survival of old river names may go back to the use of rivers in the coastal region by inhabitants of the pleistocene hinterland, which was continuously inhabited.¹⁷

Since the mid-seventies, archaeology in particular has shed new light on the habitation history of the West and North Netherlands coastal region in the first millennium.¹⁸ For the part of South Holland relevant to this article (the area near and north of the Oude Rijn), we can say that no new data has appeared since Bult and Hallewas' survey, published in 1990, of the history of habitation in South Holland between 250 and 1000.¹⁹ They found that the second half of the 3rd century saw an end – within one or two generations – to the highly intensive occupation of the area in Roman times²⁰ and that there is almost

¹¹ The widely-held notion of an original Frisian homeland or core area, where they always lived and have persisted to this very day (see, for example, Russchen 1967, 27), is also an example of the prevailing romantic perspective on ethnicity.

¹² Given that physical-anthropological research has shown little interest in the Frisian area, I will not go into the complex relationship between population-genetic developments and ethnogenetic processes.

¹³ Constandse-Westermann 1968, 220 (cf. 177–178).

¹⁴ Blok 1959a and 1959b; Gysseling 1959; Henderikx 1987, 43, appendix IV and map V, Besteman 1990, 98; Bult/Hallewas 1990, 73.

¹⁵ Gysseling 1965; Blok 1973 and 1996; Gildemacher 1993.

¹⁶ Blok 1996, 28–33. Cf. Taayke 1996, V: 197–198.

¹⁷ For habitation developments in Drenthe, see Waterbolk 1995.

¹⁸ Cf. Van Regteren Altena/Heidinga 1977; Heidinga 1987 and 1997.

¹⁹ Bult/Hallewas 1990.

²⁰ Cf. Henderikx 1987, 39–41. A recent excavation at Katwijk (Zanderij Westerbaan) suggests that far-reaching social changes even in Roman times may have influenced ethnic self-definition: two houses were built in the 2nd and 3rd centuries on top of a burial mound dating from the 1st century with 25 cremation graves (Van der Velde 1997).

no convincing evidence of habitation from the 4th, 5th and the first half of the 6th century.²¹ Despite intensified archaeological activity in the region, the possibility always remains of a *Forschungslücke*, certainly on the beach barriers. Nevertheless, we have no choice but to conclude that the area was either completely depopulated or only sparsely populated in the Migration period.

The situation is slightly different for North Holland. Here too we witness a sharp drop in population in the course of the 3rd century, but not everywhere.²² In his survey (also published in 1990) of the habitation history of North Holland in late-Roman times and the early Middle Ages, Besteman shows that some settlements (Den Burg, Schagen and Uitgeest) were still inhabited in the 4th century but that archaeological material from the 5th through to the 7th centuries is poorly represented: 5th- and 6th-century habitation may be archaeologically invisible due to the lack of imported, i.e. recognizable and dateable, pottery and our unfamiliarity with indigenous types of pottery.²³ Recent research at Schagen²⁴ and Castricum²⁵ has produced a clearer picture of 4th- and early 5th-century habitation in North Holland, while the results of excavations at Uitgeest have provided the first clear evidence of habitation in the 5th and 6th centuries.²⁶ At the same time, however, the end to the 4th- to 7th-century gap in habitation makes it clear that successive major changes occurred in this period in the number, location, scope and structure of settlements.²⁷

The discussion about changes in the North Netherlands coastal region in the late-Roman and Migration period was given a major new impetus in the 1980s, although the research on which it is based – despite recent excavations in the Frisian villages of Wijnaldum, Dongjum and Peins²⁸ – is still limited in scope.²⁹ Thanks to the work of Waterbolk, we have a clearer understanding of how the well-known settlement of Ezinge developed.³⁰ In terms of evaluating Boeles' thesis, however, his new insights are not unambiguous. On the one hand, a closer look at the excavation data from Ezinge has revealed that Van Giffen's village of Anglo-Saxon immigrants does not exist; on the other hand, the new reconstruction of Ezinge's habitation history suggests a dramatic change in the spatial organisation of the settlement in the Migration period.³¹ According to researchers of the Tjitsma *terp* near Wijnaldum in Friesland, a compara-

²¹ Bult/Hallewas 1990, 73–74. The sharp drop in population is also clearly evident in the gradual return of the natural vegetation.

²² For habitation in a substantial part of North Holland in the Roman period, see Meffert 1998.

²³ Dekker/De Weerd 1975, 49; Besteman 1990, 98–99. For Texel and Den Burg, see also Woltering 1996–1997, 324 ('At the present stage of the study little is understood of the 4th- and 5th-century AD occupation.' However, he then goes on to say: 'Despite the lack of finds which can be dated to the 4th and 5th centuries AD, there is no reason to assume that Texel was mostly or completely unoccupied during these centuries' (see also Woltering 1996–1997, 335 for a Roman/early-medieval continuity in orientation of elements in the settlement at Den Burg).

²⁴ Diederik 1996.

²⁵ Hagers/Sier 1998.

²⁶ De Koning in prep.

²⁷ Although more or less formal depositions of human material are known from different settlements, little is

known about the late-Roman/early-medieval burial ritual in North Holland.

²⁸ For Wijnaldum, see Besteman et al. 1999.

²⁹ For the entire Netherlands *terp* area, Knol reports six modern and for the most part relatively small-scale excavations that are relevant for painting a picture of this region in the late-Roman period and the early Middle Ages: Wijnaldum-Tjitsma, Tritzum-dorpswierde, Foudgum-dorpswierde, Driesum-Driesumerterp, Ezinge-dorpswierde and Heveskesklooster-dorpswierde (Knol 1993, 119–136). The number of relevant burial grounds is larger but only a few have been well or fully excavated (Knol 1993, 150 ff.).

³⁰ Van Giffen 1936; De Langen/Waterbolk 1982–1988; Waterbolk 1991.

³¹ De Langen/Waterbolk 1982–1988, 104. De Langen and Waterbolk do not see this change as marking a break or interruption in habitation because the pre-Roman/Roman radial structure has clearly been maintained outside the direct core of habitation until the present day (De Langen and Waterbolk 1982–1988, 104). Cf.

ble change is visible in the settlements of Tritsum and Wijnaldum, both in Westergo.³² In Wijnaldum we observe not only a fundamental change in the organisation of the settlement in the 5th century, but also in the construction of houses. Simple sod houses gained the upper hand over wooden, three-aisle farmsteads. In addition, the presence of imported pottery, coins and other metalware (jewellery in particular) tells us that there was a clear break in habitation in the period 300/350–425.³³ After 425, according to the *terp* researchers, immigrants from the east (i.e. Schleswig-Holstein and the area between the Elbe and Weser rivers), who are discernibly different from their predecessors in house construction, burial rituals³⁴ and material culture, took possession of Tjitsma. Some researchers, such as Knol and Galestin, doubt whether this interruption is representative of the northern coastal region as a whole,³⁵ but others, like Erdrich and Taayke, support the Wijnaldum hypothesis.³⁶ According to Erdrich, among the hundreds of metal objects from Roman times (predominantly *fibulae*) found in the North Netherlands coastal region, there are almost no examples from the period 300–425.³⁷ And following an extensive study of the ceramics, Taayke believes that there was continuity of habitation in Groningen, Oostergo and Westergo (in descending order of probability) in a very small number of places but that, in contrast to Drenthe, there is very little evidence to support this. In the first-mentioned areas there is an almost total absence of 4th-century handmade pottery. Significant here too is the fact that the pottery characteristic of the late 3rd century in the coastal region differs markedly from the subsequent ‘Anglo-Saxon’ pottery and that there is a complete absence of transitional forms or of both forms found in association.³⁸

Finally, I must discuss developments in the field of linguistics, although these are controversial.³⁹ Nevertheless, there has been recent consensus concerning the linguistic situation in the area along the

Knol 1993, 129 and 133. De Langen distanced himself in 1992 from the idea that the medieval radial arrangement of many *terps* dated back to the Iron Age (De Langen 1992, 155–186). He says that the radial organisation of the settlement of Oostergo is not representative of the medieval *terp* village and that such an arrangement only arose within level landscapes and if a settlement consisted of more than four farmsteads.

³² Gerrets/Heidinga/De Koning 1996; Gerrets 1995, 41–44 and 1999; Gerrets/De Koning 1999. For the late-Roman/early-medieval change in the spatial organisation of settlement and a possible population hiatus in Tritsum, see Taayke/Knol 1992, 87.

³³ Cf. Erdrich, who concludes on the basis of metal finds from Wijnaldum that ‘the Tjitsma *terp* came more or less to an end even before the end of the 3rd century, or at least dropped to a level which is hardly evidenced archaeologically’ (Erdrich, 1999; see also note 171). There appears to be a comparable hiatus on a *terp* in the neighbouring *terp* clusters of Dongjum and Peins: not only is there an absence of 4th-century imports there, but the entire surface of the Roman *terp* was completely ploughed and incorporated into a layer of arable land in the Migration period (unpublished excavation data 1998). See Bos and Jager (1996, 80) for a 4th-century population hiatus in a *terp* north of Goutum (Oostergo).

³⁴ Cf. Knol 1993, 156.

³⁵ Knol 1993, 109–110 and 240–241; Galestin 1996–1997.

³⁶ Erdrich 1999; Taayke 1988 and 1996, V: 193–198 and the relevant passages in Taayke’s sub-studies.

³⁷ It is important to realise that this cannot be attributed to a decline in Frisian/Roman contacts and the resulting reduced influx of Roman imports because these find types should be seen as indigenous ‘Germanic’ products.

³⁸ *Contra* Knol 1993, 202. The introduction of Driesum-style pottery in the 3rd century also meant a complete and rather abrupt change in the pottery repertoire (Taayke 1996, V: 192–193). Taayke interprets this as Frisian compliance with growing Chaucian power or the result of joint participation by Frisians and Chauci in acts of piracy. It must be said that Taayke is very quick to establish a link between pottery and ethnic groups; in other words, he gives no theoretical underpinnings for the relationship between stylistic forms of pottery and ethnic appurtenances.

³⁹ The question remains as to what historical linguistics of the Germanic – and more specifically the Frisian – language area can contribute to the present discussion if we accept, with Nielsen (1994), that:

– the earliest Old Frisian manuscripts are of relatively recent date (13th century and later) and there is disagreement about the extent to which the characteristics of

continental North Sea coast before the Migration period: until 400 an Ingvaemonic or Northwest Germanic language continuum existed here, from which Old Frisian, Old English, Old Saxon and Old Low Franconian later derived.⁴⁰ According to most researchers, this means that there cannot have been an ‘original’ Anglo-Frisian entity: the strong linguistic affinity between Frisian and English is not the product of a 5th-century Anglo-Saxon invasion of the Frisian area, but of a differential development within Northwest Germanic, whereby the precursors of English and Frisian developed in a different way and at a different pace from other Northwest Germanic languages.⁴¹ According to Seebold, however, there is no explanation for how language boundaries, such as those between Frisian on the one hand and Frankish and Saxon on the other, can arise within such a continuum.⁴² He also believes that Saxons from the Danish and North German region, known as Jutes, settled in a relatively peaceful manner among the Frisians in late-Roman times.⁴³ The language of the Jutes then became dominant in the Frisian area while the Frisian name prevailed for the new Frisian-Jutish conglomerate: Boeles’ thesis in a new guise!

Without making a definitive statement about continuity or cessation of habitation in the West and North Netherlands coastal region in the 4th or 5th century as a whole or in one of the sub-regions, we can nevertheless say that there are good reasons for doubting the continued survival of the Frisians in the late-Roman and Migration period. Using linguistic, place-name and archaeological data, there is reason to believe that radical changes occurred in the Netherlands coastal region in the 3rd and 4th centuries, and that the relatively substantial populations of the mid-Roman period were reduced to a minimum or disappeared altogether.⁴⁴ In the 2nd century, but particularly from the mid-3rd century onward, this drop in population went hand in hand everywhere with fundamental changes in the local and regional organisation of settlements and in the material culture.

Various explanations for these changes have been put forward over the course of time. Even today, as of old, people point to the political and social unrest and the economic decline brought about by a combination of two factors: the gradual decline of Roman authority and the migration of large groups to the Roman or former Roman area. Recent decades have seen a focus on deteriorating natural conditions in the coastal region. To explain the regular alternation of pockets of clay and peat layers in the Netherlands coastal region, a model was developed in the 1950s (also very popular among archaeologists and onomasticians) of a succession of marine transgressions and regressions. According to this model, the influence of the sea changed regularly ‘through differences in the speed and direction of sea-level movements and through differences in climatological conditions, mainly with regard to the frequency and extent of storms’.⁴⁵ Thus the late-Roman period supposedly saw a powerful transgression (the Dunkirk

Old Frisian that are typical of these texts can be traced back in time;

- the place-name and runological material stems almost exclusively from the 5th century or later, is often difficult to interpret and offers few clues to link the early-medieval Frisian dialect of the Netherlands coastal region to other contemporary Germanic dialects;
- none of the Germanic languages around the southern part of the North Sea developed into independent languages until the early Middle Ages, and in the case of Frisian possibly not until the 8th century, and that therefore language would initially have played only a very minor role in the formation of ethnic identities in this area in the Roman period and the early Middle Ages;
- we do not know the language of the North and West

Netherlands coastal inhabitants from the late Iron Age and the Roman period; it is even possible that it wasn’t Germanic.

⁴⁰ For a recent summary, see Van Bree 1997.

⁴¹ Stiles (1995, 212) speaks of English and Frisian as ‘Ingvaemonic relict areas’.

⁴² Seebold 1995.

⁴³ For the relationship between Jutes and Frisians, see Seebold 1995, 10-13.

⁴⁴ There was also a marked interruption in habitation in the *terp* area of North Germany; however, it began later (in the mid- to late 5th century) and lasted longer (until well into the 6th or 7th century).

⁴⁵ Beets/Van der Spek/Van der Valk 1994, 10.

II-transgression) that rendered large parts of the Netherlands coastal region uninhabitable. Nowadays people are sceptical of these area-independent processes⁴⁶ and focus instead on regional, coast-forming developments, which are affected by factors such as sediment supply, water-storage capacity and human intervention. These had very different effects in the 3rd to the 7th centuries in Zeeland and Goeree-Overflakkee,⁴⁷ the estuaries of the Maas and the Oude Rijn, North Holland, the area between Texel and Friesland, Westergo,⁴⁸ Oostergo and Groningen. In none of these areas are we able to establish a clear causal link between deteriorating natural conditions and the decline or disappearance of the population. Therefore, although the Frisian area was not exactly a land of milk and honey in the late-Roman period, doubts remain as to whether changes in the natural environment were the 'prime mover'. For large parts of the coastal region, however, the above circumstances do appear to explain why there was little or no habitation for long periods in some sub-regions.⁴⁹ In my conclusion, I will return briefly to the possible causes of the demographic changes in the Netherlands coastal region in the late-Roman period.

3 THE SURVIVAL OF THE FRISIAN NAME

In the previous section we have seen that the West and North Netherlands coastal region was subjected to such far-reaching changes in the 3rd and 4th centuries that habitation fell dramatically or ceased altogether. In the latter case the new 5th-century inhabitants will have come from outside, which raises the question of how we can explain the continued use of the Frisian name. The former case gives rise to the same question. To what extent would the residual population have been in a position to generate the substantial population growth of the 5th and 6th centuries? Or should we here too be thinking in terms of immigration from other areas? However we answer this last question, the changes in the 3rd, 4th and 5th centuries were so far-reaching that they must have influenced the ethnic self-definition of the residual Frisian population.

In addition to the usual answers, I believe there are two additional ways of explaining why the Frisian name continued to be used. Both disregard the hypothesis that the early-medieval Frisians were the true descendants of the Roman Frisians, which could be possible even if we accepted that there was a population hiatus in the assumed core Frisian area (i.e. present-day Friesland and Groningen). Yet, as recent research shows, there seems to have been a certain continuity of habitation in North Holland. As I have already indicated, I find this hypothesis implausible because the far-reaching changes which are also archaeologically visible in North Holland would certainly have influenced the ethnic self-definition of its residual population. If this were not the case, then the Frisians must indeed be the exception to the late-Roman rule. I have one more reason to doubt this explanation and that is the absence of the Frisians in 4th, 5th and 6th-century historical sources. But more of that later.

The first alternative answer is that new inhabitants called themselves after the more or less empty area that they colonised or after the former or residual inhabitants of the colonised area. It is accepted by anthropologists that groups devote considerable space in their foundation myths to the origin and nature of their relationships with the original inhabitants.⁵⁰ It is therefore interesting to quote from the work of the 7th-century writer Fredegarius. Discussing the Trojan origin of the Franks, he says:

'The first king they had was Priam; it is written throughout books of history how later they had Frigas as their king. Afterwards they were divided into two groups. One group reached Macedonia and they were called

⁴⁶ Beets/Van der Spek/Van der Valk 1994, 11.

⁴⁷ Vos/Van Heeringen 1997.

⁴⁸ Vos 1999.

⁴⁹ Cf. Henderikx 1987, 45.

⁵⁰ E.g. Platenkamp 1993. However, I know of no examples in which the immigrants were renamed after the original inhabitants.

*Macedonians after the people by whom they were received and after the region of Macedonia. They had been invited by these people, who were oppressed by the neighbouring tribes, so that they could offer them help. After they were united with these people, they grew numerous in offspring. From this tribe the bravest Macedonian warriors were created and their reputation later confirmed this in the days of King Philip and his son Alexander – such was their bravery’.*⁵¹

In other words, in the eyes of scholarly contemporaries, it was possible for immigrants to rename themselves after the original population and the area they inhabited. Interestingly, Fredegarius’ story shows strong parallels with the early-modern/modern picture of Frisian history: did the residual Frisian population not have much to endure from neighbouring tribes (first the Chauci, and later the Franks and Saxons), and could they not have used the support of others? Did their numbers not grow again quickly after a time? And, finally, in the days of Aldgisel and Redbad were they not regarded as a people who once again inspired awe? Perhaps these similarities reveal the deep historical, literary roots of prevailing but stereotypical notions about Frisian history. The question is whether, in their descriptions of the peoples occupying the northern periphery of the civilised world, early-medieval authors were similarly and perhaps even more directly indebted to an older tradition.

The second answer, and the one I wish to elaborate on here, is that the Frisian name was brought into circulation once again by outsiders in the course of the early Middle Ages. In a socio-political and ethnic sense, the Frisian area may have become so heterogeneous during the Migration period that when it came to naming the area, people reached back to the familiar – to the name of the inhabitants who had lived there in classical times. For these outsiders, I am thinking mainly of Frankish and/or Gallic senatorial elites. They had access not only to Roman documents that made frequent mention of the Frisians, but also to late-antique maps and encyclopaedic descriptions of the world, in which the Frisians played an enduring role. In their increasingly intensive contact with the Franks, it became natural for the inhabitants of the Netherlands coastal region to adopt the ethnic terminology of their more powerful neighbour.⁵² In a similar fashion, when it came to naming themselves, groups to the right of the Rhine had centuries earlier allowed themselves to be influenced by the Roman custom of referring to them as *Germani*.⁵³ The most important foundation for this hypothesis is the lack of references to the name Frisian in 4th, 5th and 6th-century sources: there was no mention of Frisians for almost 300 years.

It is remarkable that the last report of Frisians in Roman times was in the early 4th century when imperial eulogists commented that the *Frisii* had been defeated and were settled in Gaul, where they ‘exhaust themselves working the muddy soil’.⁵⁴ Although the Lower Rhine area moved further and further away from the Roman field of vision in the 4th and 5th centuries and late-classical authors came to see the Frisians as part of the Franks or Saxons,⁵⁵ it is nevertheless surprising that the Frisians do not feature in the many reports about the often violent confrontations between Germanic groups and the Romans. And it is all the more surprising if we wish to view the Frisians as a developing *Grossstamm* like the Franks and the Saxons. Nor do we encounter Frisians, as we do for instance the Franks, as German officers in Roman service, and nothing is known about Frisian army units in the late-Roman period. A long silence followed the early 4th-century mention, which is perhaps not so surprising in the light of the changes observed by archaeologists.

⁵¹ Fred. *Chron.*, SSRM II, 45; translation after Gerberding 1987, 14.

⁵² See Wood 1994, 54 and 160-161 for the few clues to Frisian political independence from the Merovingians in the 6th and early-7th centuries.

⁵³ Lund 1991, 1956-1988.

⁵⁴ *Pan. Lat.* 8 (5) (cf. De Boone 1954, 57 and 61). I will not discuss here the early 5th-century reference to ‘Frisian horses’ in Vegetius’ *Mulomedicina* (cf. Boeles 1951² (1927), 196) because such a ‘brand name’ can survive quite separate from the eponymous ethnic group.

⁵⁵ Hiddink 1999.

The first to mention the Frisians (*Frisonnes*) again was the Byzantine writer Procopius, in his books on the history of Justinian's wars, completed about the mid-6th century.⁵⁶ Together with the *Angiloi* and *Brittones*, they were named as the inhabitants of the island of Brittia.⁵⁷ In my view, the reliability of this report is open to question. Firstly, these Frisians are 'out of place', in other words, in England. According to Procopius, a wall divided Brittia into an inhabited and an uninhabited part.⁵⁸ Most researchers are of the view that this referred to Hadrian's wall, but is that really the case? Procopius distinguishes Brittia from Britannia, the designation that he uses for England elsewhere in his work.⁵⁹ Secondly, and this is underlined by my comment on the distinction Procopius makes, his knowledge of the Northern regions was poor, even though he had access, as he himself says, to Frankish and Anglian informants.⁶⁰ Thirdly, the chapter is not about Frisians. Procopius speaks at length about another group – the mysterious *Varni* – who perhaps were located in the Netherlands coastal region, on the Rhine estuary. But this is not the place to pursue the many problems relating to the origin and location of this latter group.⁶¹

The reliability of the next mention of the Frisians, thirty years later in 580, is also open to question. This concerns a reference in a eulogy for the Merovingian king Chilperik by the poet Venantius Fortunatus from Ravenna:⁶²

*'You [Chilperik, JB], inspire fear in the Goths, the Basques, the Danes, the Jutes, the Saxons and the Britons. With your father, as men know, you vanquished them in battle. You are a terror to the furthest Frisians and the Suebi, who seek your rule rather than prepare to fight you.'*⁶³

As we have already seen, historians nowadays attach little value to such lists of tribes in which old names suddenly reappear because the eulogies of late-antique poets often had only a partial foundation in historical reality.⁶⁴ After all, names had to fit the metre and, in order to convey the special status of the subject's deeds, they had to be part of the classical canon. The Frisians did belong to that canon, certainly for scholars such as Fortunatus who had enjoyed a broad classical education in Ravenna and who probably knew at first hand the work of Tacitus.⁶⁵ Because of their participation in the revolt of 28 AD, the fame of the Frisians had spread not only among the Germans, as Tacitus comments, but also – thanks partly to Tacitus himself – among the Romans. It is therefore not surprising that, with a little juggling, we can recognise a garbled version of the Frisian name on the 4th-century *Tabula Peutingeriana*⁶⁶ and in an anonymous late 5th-century description of the world.⁶⁷ In the latter work we encounter *Frusiones* among other important early-Roman groups like the *Cannifates*, *Catti*, *Cauci* and *Haedui*, whose survival into the early Middle Ages is impossible to trace.

But didn't the Frisians nevertheless play a key role in early 6th-century events surrounding the raid by the Danish king Hygelac or Chlochilaichus into the Merovingian kingdom of Theoderic? True, if we accept that *Beowulf*, a poem dating from the 8th, possibly 10th century, is a faithful account of events that

⁵⁶ Proc. BG, VIII, 20.7.

⁵⁷ Proc. BG, VIII, 20.47-58. According to Procopius, some believed that Brittia was the house for the souls of the dead.

⁵⁸ Proc. BG, VIII, 20.42.

⁵⁹ Cf. Cameron 1985, 215 (with further references). Some authors have suggested that this refers to Bretagne, but what were the Frisians doing there?

⁶⁰ Cameron 1985, 214-216.

⁶¹ See, for example, De Boone 1951.

⁶² For Venantius Fortunatus, see George 1992.

⁶³ Ven. Fort., *Op. poet.* 9.1 (poem for King Chilperic on the occasion of the synod of Berny-Rivière; George 1995).

⁶⁴ Pohl 1997; Heather 1998. Pohl even regards this passage from Venantius Fortunatus as a paradigmatic example.

⁶⁵ For Fortunatus' education and extensive knowledge of the Latin and Greek classics, see George 1992, 20-22.

⁶⁶ De Boone 1954, 21-22; 156 note 49.

⁶⁷ *Cosmographia* 13. See also the 4th-century *Laterculus Veronensis* 13, in which the Crinsiani (Frisi(avi)?) are included in a summary of barbarian tribes, and the *Notitia dignitatum* (occ. 40,36), which speaks of *Frixagi*.

had taken place two to four hundred years earlier,⁶⁸ which is unlikely. After all, Gregory of Tours, who wrote about the Danish raid a little more than fifty years after the event, and who may have based his story on eyewitness accounts, makes no mention of Frisians.⁶⁹ *Beowulf* scholars agree that the poem cannot be used as a *Fundgrube* for historical facts. *Beowulf* is not an epic narrative that arose directly out of the oral tradition of the Migration period, but a composition that was immediately committed to writing in the 8th century or later – in other words a *new* composition, from the mind of a Christian author with links to the highest nobility.⁷⁰ As we have seen above, it is in such a context that a Trojan origin was ascribed to the Franks. What then does this mention of Frisians mean in a digression in *Beowulf*? Given the Frankish-Frisian involvement of the 7th and 8th centuries, I think it highly likely that the Frisians did not acquire a prominent place in English narratives until that time. The social space depicted in *Beowulf* is not a historical space but a literary one, to be understood in the specific politico-historical context out of which the poem arose and not in terms of the period in which the events mentioned in the story were supposed to have taken place.

Finally I must discuss a 6th-century reference to *Frisia* from an unexpected quarter.⁷¹ It concerns a coin type with the legend (obverse face) *AVDVLFVS FRISIA* and (reverse face) *VICTVRIA AVDVLFVO* (five examples) or (obverse face) *FRISIA* and (reverse face) *AVDVLFVS* (two examples).⁷² We can confidently date the production of these coins as both types occur in the treasure of Escharen, which was hidden in the ground around 600. Although the edge inscription is open to interpretation,⁷³ different numismatists have stated that this involves a mintage by an unknown Frisian king or ruler.⁷⁴ Such a hypothesis would shed new light on the continuation of the Frisian name because it suggests that the name *Frisia* was once again used, or was still in use, around 600 in the Frisian area. Pol, however, points out two important problems regarding Frisian claims to this coin type. Firstly, as Boeles has already suggested,⁷⁵ it is difficult to reconcile the fine stylistic quality with Frisian coin production; instead, it seems to point to a northern Frankish origin.⁷⁶ Secondly, the use of a country name would be unique, since geographical names on early-medieval coins are generally associated with *pagi*.⁷⁷

In other words, none of the 6th-century references to the Frisians is without its problems. In fact, not until the 7th century was there regular contact between the Frisians and the Franks, with the Franks using the labels *Frisia* and *Frisians*.⁷⁸ There is a gap of over 300 years, or about ten generations, between the last mention of the Frisians in Roman sources and the first in early-medieval sources. And this despite the fact that the Lower Rhine area does occur in the sources; for example, in the 4th and 5th centuries there is reference to Franks and Saxons for this area and in the 5th and 6th centuries to Varni (or Warni),

⁶⁸ On the contested dating of *Beowulf*, see Bjork/Obermeier 1997.

⁶⁹ Greg. Tur. *Hist.* III-3. Oddly, Frisians do not feature at all in his extensive writings – more food for thought.

⁷⁰ Cf. Bjork/Obermeier 1997, 28–31.

⁷¹ The paragraph below is based on Pol in prep.

⁷² In the past, a copy of an Anastasian *triens* has also been ascribed to Friesland because it bears a legend ending in *FRIS* (Boeles 1951² (1927), 268 (fig. 55.1) and 272). This is unlikely, however, because the quality of the imitation is too good and because *FRIS* probably arose out of *PPAUG* when the coin was double struck.

⁷³ For example, Lafaurie suggests that this was an unknown Frankish luminary who won a victory over the Frisians and assumed the royal privilege of being regarded as a victor (Lafaurie 1959–1960, 205).

⁷⁴ Engel/Serrure 1891, 188–189; Lafaurie 1959–1960, 205 (with some uncertainty: ‘En l’absence de données certaines les solutions proposées au problème posé par ces triens ne peuvent être que des hypothèses’); Grierson 1973–1974, Faber 1998; Felder unpublished.

⁷⁵ Boeles 1951² (1927), 272.

⁷⁶ According to Prou 1892, nr. 615 and De Belfort 1892–1895, nr. 1934, for reasons that are unclear. Both regard *FRISIA* as a place where coins were minted.

⁷⁷ I should point out here that the name *AVDVLFVS* can be both Frankish and Frisian: a Latinisation of the Frankish Odolf or of the Old Frisian Adolf respectively (Bremmer 1982, 185).

⁷⁸ The *vita* of Saint Eligius of Noyon is the first example of this (*V. Eligii*). See the corpus of texts in Lebecq 1983 (vol. II) for later mentions of Frisians and Frisia.

Heruli, Jutes and Suevi.⁷⁹ We should therefore consider the possibility that there were no groups in the area who called themselves Frisians. Instead, the name became current once again when the Franks, in their increasingly intensive contact with the northern world, reintroduced it, partly influenced by the work of men of letters such as Fortunatus, who was familiar with classical ethnography.

Is the scenario I have just described plausible? I believe so. There are various other examples from the southern world of Merovingian/Carolingian interference in the naming of tribal groups, places and regions in the North:

- 1. the name *Frisia citerior*, literally 'Frisia on this side'. Bede is the only one who uses this name,⁸⁰ and we can only explain it from a Frankish perspective. Bede was probably following the usage of the English mission, under Austrasian patronage, whose members he knew personally;
- 2. *pagus* of *Toxandria*, the generally accepted name, mentioned in 8th-century texts, for a significant part of Brabant.⁸¹ Given the archaeologically well-documented breaks in habitation in this area in the 4th century and in the period from 475 to 550, this cannot be a local survival of the geographical name *Toxandria*, in use since late Roman times (the 1st-century *Texuandri* had long disappeared from history),⁸² but instead a Frankish name from outside;⁸³
- 3. *Sugambri*, the customary name for the Franks under the Gallic senatorial elite.⁸⁴ This group had suffered a crushing defeat in 8 BC against the Romans. Later, the name of their tribe was only found in late-antique poetry, where they lived on as an illustrious people. Once again, this usage is based on a late-Roman example;⁸⁵
- 4. the name *Traiectum* for present-day Utrecht. Bede relates that, at the time of Willibrord's mission, the *castellum* given to the missionary by Peppin was called 'Wiltaburg, or the *oppidum* of the Wilts, in the ancient language of the people, but *Traiectum* in the *lingua Gallica*'.⁸⁶ In view of the present-day name, the name of the former inhabitants of Utrecht and the surrounding area was obviously no match for that of the more powerful Austrasian elite;⁸⁷
- 5. the name *insula Batavorum*. In accordance with late-Roman usage,⁸⁸ the Betuwe was given a variant of the geographic name *Batavia* in 8th-century and later documents.⁸⁹ This will have reflected the local name. Strikingly, however, this name is not used in written sources associated with the royal court, such as the *Annals of St. Bertin* and Einhard's *Life of Charlemagne*. Instead, we encounter phrases like *insula Batavorum* and *insula Batavorum in Rheno* that unmistakably go back to early-Roman descriptions.⁹⁰

⁷⁹ Cf. De Boone 1951.

⁸⁰ Bede *Hist.* V, 10.

⁸¹ See the many charters for Brabant in the *Liber Aureus Epternacensis* (Camps 1979). Cf. Theuws 1988, 109-120.

⁸² Cf. Amm. R. *Gest.* XVII, 8, who speaks of the *Salii* who settled *apud Toxandriam locum* in about 358.

⁸³ According to Theuws 1988, 109.

⁸⁴ See for example Greg. Tur. *Hist.* 2,31, which describes how Bishop Remigius said to Clovis at his christening: 'Humbly bow your head, Sicamber', and Sidon. Apoll., *Epist.* V 6, 35, which names an 'old Sicamber' at the court of the Visigothic King Euric.

⁸⁵ For example, Claudian, *In Eutropium* I, 383.

⁸⁶ Bede *Hist.* V, 11. Willibrord may have been confusing Utrecht with Wiltenburg as the latter name was also used in the Middle Ages to refer to the Roman *castellum* of Vechten, which we can show also went by its Roman name in Willibrord's time (Henderikx 1987, 81-82 and 85-86).

⁸⁷ It is also tempting to attribute the survival to the present day of other Roman names west of Nijmegen to the much-intensified interference by the Merovingians and Carolingians with the Roman *limes* in the course of the 7th century. They probably regarded the *limes* as part of the Roman *fiscus* and therefore as the rightful possession of the king (cf. Lebecq 1983, 112). However, it is striking that many prehistoric names are also known from this area – i.e. the river area from Nijmegen to just beyond Utrecht (cf. Blok 1981, 145).

⁸⁸ E.g. Zos., *Hist.* 3,8,1.

⁸⁹ For example, in the oldest text from 726, there is reference to *in pago Batuvua* and *in Batuvua* (Künzel, Blok and Verhoeff 1989² (1982), 87).

⁹⁰ For a summary of these phrases, see Künzel, Blok and Verhoeff 1989² (1982), 87 (Betuwe). We could add *Ann. Bert.* ad 850: *Batavum insulam* and Einhard, *V. Kar.* 17: *Batavorum insulam*.

The Roman/early-medieval continuation of the Frisian name has always played an important role in the historiography of the North Netherlands coastal region. For many generations of historians and archaeologists, all of whom were influenced by romantic notions of ethnicity, it could only mean that successive generations of coastal inhabitants had called themselves Frisians – quite apart from the vicissitudes of history – from the very beginnings in the Iron Age until the present day. Even Boeles, who believed that dramatic changes had occurred in the Frisian area in the 4th and 5th centuries, could not escape the power of this ‘fact’: he said that although the Frisians may have been caught unawares by the Anglo-Saxons, their old tribal name had become general currency for the new Anglo-Saxon/Frisian conglomerate.

There is, however, an important reason to doubt this seemingly obvious continuation of the Frisian name. Place-name, archaeological and possibly linguistic research has revealed that major changes swept the West and North Netherlands coastal region from the 3rd to the 5th century: in addition to changes in the material culture, the burial ritual, the construction of houses and settlements and the naming of places and regions, most striking is the huge drop in population and perhaps even the temporary disappearance of people in many areas. The reasons for this latter phenomenon are not completely clear, but deteriorating natural circumstances were probably not decisive, except that some parts of the coastal region remained uninhabitable in a somewhat later period. In my view the depopulation could also be the result of intertribal raids on relatively unprotected and small scale societies in an area that was easily accessible by sea.⁹¹ In the world around the North Sea basin, raiding was a socio-cosmological practice that was deeply rooted in late prehistory, vital to the growing to maturity of young warriors and to the reproduction of the society as a whole.⁹² The disappearance of the Roman monopoly on violence left room for the return of raiding, especially in the coastal region to the south of the *limes* and the Southern North Sea region.⁹³ It is no coincidence that the societies in North Germany and Denmark that may have been responsible for these raids underwent important changes in the 4th and 5th centuries.⁹⁴

Historians have pointed out the need, when studying ethnogenetic processes in Europe during this period, to pay particular attention to the much-discussed tribal elites, who had links with one another and with the church and its institutions and who were acquainted with the literary-ethnographic legacy of the classical world. Although the Frisian name may have been passed down in the Netherlands coastal region itself (either by successive generations of indigenous inhabitants or by newcomers who called themselves after the former inhabitants of the colonised area), we should bear in mind the possibility that the Frankish elite, by reaching back to old classical knowledge, reintroduced the Frisian name when naming places and groups in the northern periphery of the empire. There are various indications, and this may be one of them, that the area gradually became incorporated, not just in a specific power-political sense but also in a conceptual sense, despite the naming of place and inhabitants by the indigenous population.

Finally I wish to point out that this hypothesis – that the Franks may have been responsible for naming the Frisians – sheds new light on a number of other questions: the difficulties of demonstrating Frisian participation in the *adventus Saxonum*⁹⁵ and the early-medieval socio-political structure of Frisian society.⁹⁶ If we accept that the *Frisii* underwent a process of change in the 3rd and 4th centuries which strongly influenced their ethnic identity and ultimately led to the loss of that identity, it is perhaps not

⁹¹ Cf. Näsman 1991, 28.

⁹² Cf. Bazelmans 1996 for raiding as a socio-cosmological practice.

⁹³ See Hiddink 1999 for the developments in raiding around the North Sea basin.

⁹⁴ See, for example, Hedeager 1992.

⁹⁵ Cf. Bremmer 1981 and 1990; Fellows-Jensen 1995.

⁹⁶ Cf. De Langen 1995, Nicolay 1998; Bazelmans/Gerrets/Pol 1999.

so surprising that we have difficulties proving a Frisian role in the *adventus*.⁹⁷ The reference point for the early-medieval socio-political structure of Frisian society is usually the united Frisian kingdom of the late 7th century. The question is, however, whether Aldgisl and Redbad's sphere of influence did in fact cover the entire Frisian area. There is evidence to suggest that the Frisian region was much more fragmented in a socio-political and ethnic sense. Why, for example, does the *Lex Frisionum* make a tripartite division between the area between the Sincfal and Vlie, between the Vlie and Lauwers, and between the Lauwers and Eems?⁹⁸ And why did the Carolingians not take possession of the entire Frisian area at once when the Frisian kingdom fell at the death of Redbad? This may have been because – concealed behind a unity constructed by the Franks and ultimately also one that was politically and ecclesiastically engineered – there was originally an amalgamation of different societies.

CLASSICAL AND MEDIEVAL SOURCES

(For the *Panegyrici Latini*, Claudian's *In Eutropium*, the *Notitia Dignitatum* and the *Laterculus Veronensis*, see Byvanck, 1931, *Excerpta Romana* I, 372-382, 455, 562-575 and 548-550 respectively).

- Ammianus Marcellinus, *Rerum Gestarum*, ed. and transl. W. Seyfarth, 1968-1971: *Römische Geschichte*, Berlin (Schriften und Quellen der Alten Welt 21).
- Annales Bertiniani*, ed. G. Waitz, 1883: *Monumenta Germaniae historica. Scriptores rerum Germanicarum in usum scholarum separatim editi* 5, Hannover; transl. J.L. Nelson, 1991: *The Annals of St. Bertin*, Manchester/New York (Ninth-century histories 1).
- Beda, *Historia ecclesiastica gentis Anglorum*, ed. and transl. B. Colgrave and R.A.B. Mynors, 1991 (1969), *Bede's Ecclesiastical history of the English people*, Oxford (Oxford medieval texts).
- Beowulf*, ed. Fr. Klaeber, 1950³: *Beowulf and the fight at Finnsburg*, Lexington (Mass.); transl. S.A.J. Bradley, 1982: *Beowulf*, in S.A.J. Bradley, *Anglo-Saxon poetry*, London/Melbourne, 408-494.
- Cosmographia*, ed. A. Riese, 1878: *Geographi Latini Minores*, Heilbronn.
- Dio, *Historiae*, ed. and transl. E. Cary, 1914-1927, *Dio's Roman history*, Cambridge/London (The Loeb classical library).
- Einhart, *Vita Karoli Magni*, ed. and transl. F. X. Herrmann, 1982: *Vita Karoli Magni*, Einhart, Münster (Aschendorff's Sammlung lateinischer und griechischer Klassiker).
- Fredegar, *Chronicarum quae dicuntur Fredegarii Scholastici Libri IV Cum Continuationibus*, in *Monumenta Germaniae Historica, Scriptores rerum Merovingicarum (SSRM)* II, Hannover, 1888, 1-193.
- Gregorius van Tours, *Historiae*, ed. B. Krusch and W. Levison, 1951²: *Monumenta Germaniae Historica, Scriptores rerum Merovingicarum* 1.1; transl. F.J.A.M. Meijer, 1994: *Gregorius van Tours. Historiën*, Baarn.
- Lex Frisionum*, ed. and transl. K.A. Eckhardt and A. Eckhardt, 1982: *Lex Frisionum, Monumenta Germaniae Historica. Fontes Iuris Germanici Antiqui*, Hannover.
- Panegyrici Latini*, ed. and transl. R.A.B. Mynors, C.E.V. Nixon and B.S. Rodgers, 1994: *In praise of later Roman emperors*, Berkeley etc. (The transformation of the classical heritage 21).
- Ptolemaeus, *Geographia*, ed. and transl. E.L. Stevenson, 1932: *Geography of Claudius Ptolemy*, New York.
- Procopius, *De Bellis*, transl.: H.B. Dewing, 1978: *Procopius, History of the wars*, Cambridge (Mass.)/London.
- Tacitus, *Germania*, ed. and transl. M. Fuhrmann, 1995: *Germania*, Stuttgart.
- Sidonius Appollinaris, *Epistulae et carmina*, ed. and transl. W.B. Anderson, 1936-1965: *Poems and letters. Sidonius*, London (The Loeb classical library; 296, 420).

⁹⁷ This does not mean, however, that people from the Netherlands coastal region did not take part in the *adventus*.

⁹⁸ *L. Fris. passim*.

- Venantius Fortunatus, *Opera Poetica*, in *Monumenta Germaniae Historica, Auctores Antiquissimi* 4.1, Berlin, 1881. transl. J. George, 1995: *Venantius Fortunatus: personal and political poems*, Liverpool (Translated texts for historians 23).
- Vita Eligii*, ed. B. Krusch, *Monumenta Germaniae Historica. Scriptorum Rerum Merovingicarum* IV, Hannover and Leipzig, 1902, 632-742.
- Zosimus, *Historia Nova*, ed. F. Paschoud, 1971-1989; transl. O.Veh, 1990: *Neue Geschichte*, Stuttgart (Bibliothek der griechischen Literatur).

REFERENCES

- Bazelmans, J. 1999: *By weapons made worthy. The relationship between lord and warrior-follower in Beowulf*, Amsterdam (Amsterdam Archaeological Studies 5).
- Bazelmans, J., 2001: Die spätrömerzeitliche Besiedlungslücke im niederländischen Küstengebiet und das Fortbestehen des Friesennamens, *Emder Jahrbuch für historische Landeskunde Ostfrieslands* 81, 7-61.
- Bazelmans, J./D. Gerrets/A. Pol, 2002: Metal detection and the Frisian kingdom. Questions about the central place of northern Westergo in the early Middle Ages, *Berichten van de Rijksdienst voor het Oudheidkundig Bodemonderzoek* 45, 219-241.
- Beets, D.J./A.J.F. van der Spek/L. van der Valk, 1994: *Holocene ontwikkeling van de Nederlandse kust*, Haarlem (RGD rapport 40.016, project Kustgenese).
- Besteman, J.C., 1990: North Holland AD 400-1200: turning tide or tide turned?, in J.C. Besteman/J.M. Bos/H.A. Heidinga (eds), *Medieval archaeology in the Netherlands. Studies presented to H.H. van Regteren Altena*, Assen/Maastricht, 91-120.
- Besteman, J.C./J.M. Bos/D.A. Gerrets/H.A. Heidinga/J. de Koning (eds), 1999: *The excavations at Wijndum. Reports on Frisia in Roman and medieval times 1*, Rotterdam (Reports on Friesland in Roman and medieval times 1).
- Bjork, R.E./A. Obermeier, 1997: Date, provenance, author, audiences, in R.E. Bjork/J.D. Niles (eds), *A Beowulf handbook*, Exeter, 13-34.
- Blok, D.P., 1959a: De vestigingsgeschiedenis van Holland en Utrecht in het licht van de plaatsnamen, in M. Gysseling/D.P. Blok (eds), *Studies over de oudste plaatsnamen van Holland en Utrecht*, Amsterdam, 13-33.
- Blok, D.P., 1959b: Toponymics and the settlement history of the western Netherlands, *Studia onomastica Monacensia* 3, 154-159.
- Blok, D.P., 1973: De eigen inbreng van de plaatsnaamkunde in de nederzettingsgeschiedenis, *Naamkunde* 5, 223-243.
- Blok, D.P., 1981: Hoofdlijnen van de bewoningsgeschiedenis, in D.P. Blok *et al.* (eds), *Algemene geschiedenis der Nederlanden 1: Middeleeuwen*, Haarlem, 143-152.
- Blok, D.P., 1996: Das Alter der friesischen Wurtamen, in T. Looijenga/A. Quak (eds), *Frisian runes and neighbouring traditions*, Amsterdam/Atlanta (Amsterdamer Beiträge zur älteren Germanistik 45), 25-34.
- Boeles, P.C.J.A., 1906: Die Terp zu Hogebeintum, *De vrije Fries* 20, 426-430.
- Boeles, P.C.J.A., 1927: *Friesland tot de elfde eeuw*, Den Haag.
- Boeles, P.C.J.A., 1951² (1927): *Friesland tot de elfde eeuw. Zijn voor- en vroege geschiedenis*, Den Haag.
- Bos, J./A. Jager, 1996: Een terpzool in Goutum-Noord (Fr.): weer raak, *Paleoaktueel* 7, 79-81.
- Bremmer, R.H., 1981: Frisians in Anglo-Saxon England: a historical and toponymical investigation, *Fryske Nammen* 3, 45-94.
- Bremmer, R.H., 1990: The nature of the evidence for a Frisian participation in the *Adventus Saxonum*, in A. Bammesberger/A. Wollmann (eds), *Britain 400-600: language and history*, Heidelberg, 353-372.

- Bult, E.J./D.P. Hallewas, 1990: Archaeological evidence for the early-medieval settlement around the Meuse and Rhine deltas up to ca AD 1000, in J.C. Besteman/J.M. Bos/H.A. Heidinga (eds), *Medieval archaeology in the Netherlands. Studies presented to H.H. van Regteren Altena*, Assen/Maastricht, 71-90.
- Byvanck, A.W., 1931: *Excerpta Romana. De bronnen der Romeinsche geschiedenis van Nederland, vol. I: Teksten*, 's-Gravenhage (Rijks Geschiedkundige Publicatiën 73). [cf. now also <http://www.inghist.nl/retroboeken/excerpta/>].
- Cameron, A., 1985: *Procopius and the sixth century*, London.
- Camps, H.P.H., 1979: *Oorkondenboek van Noord-Brabant tot 1312, 1, De Meierij van 's-Hertogenbosch (met de heerlijkheid Gemert). Eerste stuk (690-1294)*, 's-Gravenhage.
- Constandse-Westermann, T.S., 1968: *Fysisch anthropologische beschouwingen over de Nederlandse bevolking: een poging tot synthese*, Utrecht.
- De Belfort, A., 1892-1895: *Description générale des monnaies mérovingiennes*, Paris.
- De Boone, W.J., 1951: De lage landen in de Westeuropese politiek omstreeks 500, *Tijdschrift voor geschiedenis* 64, 45-54.
- De Boone, W.J., 1954: *De Franken. Van hun eerste optreden tot de dood van Childerik*, Amsterdam.
- Dekker, L.W./M. de Weerd, 1975: Bodemvondsten en bodemopbouw in Midden-West-Friesland, *Boor en spade* 19, 39-53.
- De Koning, J., in prep.: *Noord-Holland, in het bijzonder Kennemerland en West-Friesland tussen de 3de en 10de eeuw*.
- De Langen, G.J., 1992: *Middeleeuws Friesland. De economische ontwikkeling van het gewest Oostergo in de vroege en volle Middeleeuwen*, Groningen.
- De Langen, G.J., 1995: Het Friese kweldergebied in de vroege Middeleeuwen, *Madoc* 9, 172-187.
- De Langen, G.J./H.T. Waterbolk, 1982-1988: De archeologie van Ezinge. De nederzettings- en onderzoeksgeschiedenis van een Gronings terpdorp, *Jaarverslagen van de Vereniging voor Terpenonderzoek* 66-72, 78-111.
- Diederik, F., 1996: Schagen: Witte Paal III, in R.M. van Heeringen/M. Meffert (eds), *Archeologische kroniek van Holland* 3, 350-351.
- Engel, A./R. Serrure, 1891: *Traité de numismatique du Moyen Age* 1, Paris.
- Erdrich, M., 1999: Continuity and discontinuity: native and Roman metal finds from Wijaldum, in J.C. Besteman/J.M. Bos/D.A. Gerrets/H.A. Heidinga (eds), 171-184.
- Faber, K.P.H., 1998: Audulfus, een Friese koning!, *Fryslân* 4 (4), 29-30.
- Fellows-Jensen, G., 1995: What do English, Frisian and Scandinavian place-names tell us about the Frisians in the migration period, *Friesische studien* 2, 97-118.
- Galestin, M.C., 1996-1997: The dark age concept and the Frisian terp area, *Caeculus* 3, 123-129.
- George, J.W., 1992: *Venatius Fortunatus. A Latin poet in Merovingian Gaul*, Oxford.
- George, J.W., 1995: *Venantius Fortunatus: personal and political poems*, Liverpool (Translated texts for historians 23).
- Gerberding, R.A., 1987: *The rise of the Carolingians and the Liber Historiae Francorum*, Oxford.
- Gerrets, D.A., 1995: The Anglo-Frisian relationship seen from an archaeological point of view, *Friesische studien* 2, 119-128.
- Gerrets, D.A., 1996: Continuity and change in house construction and the lay-out of rural settlements during the early Middle Ages in the Netherlands, *Ruralia* 1, Praag (Památky Archeologické, Supplement 5), 33-46.
- Gerrets, D.A., 1999: Evidence on political centralization in Westergo: the excavations at Wijaldum in a (supra-)regional perspective, in *Anglo-Saxon studies in archaeology and history* 10, 119-126.
- Gerrets, D.A./H.A. Heidinga/J. de Koning, 1996: Over oude en nieuwe Friezen. De komst van migranten naar de terp Tjitsma bij Wijaldum (Fr.), *Paleoaktueel* 7, 82-85.

- Gerrets, D.A./J. de Koning, 1999: Settlement development at Wijnaldum-Tjitsma, in J.C. Besteman/J.M. Bos/D.A. Gerrets/H.A. Heidinga (eds), 73-124.
- Gildemacher, K.F., 1993: *Waternamen in Friesland*, Leeuwarden (Fryske nammen 9).
- Grierson, Ph., 1973-1974: A new Audulfus Frisia triens, *Jaarboek voor munt- en penningkunde* 60-61, 153-155.
- Gysseling, M., 1959: De oudste plaatsnamen in Holland en Utrecht, in M. Gysseling/D.P. Blok (eds), *Studies over de oudste plaatsnamen van Holland en Utrecht*, Amsterdam, 1-12.
- Gysseling, M., 1965: Het chronologisch probleem bij de jongprehistorische en vroegmiddeleeuwse nederzettingen, *Mededelingen van de Vereniging voor Naamkunde te Leuven en de Commissie voor Naamkunde te Amsterdam* 41, 90-97.
- Hagers, J.K./M. Sier (eds), 1998: *Castricum-Oosterbuurt, bewoningssporen uit de Romeinse tijd en de middeleeuwen*, Amersfoort (Rapportages Archeologische Monumentenzorg 53).
- Halbertsma, H., 1958: Terponderzoek tussen Flie en Eems, gedurende de jaren 1947-1957, *Friesisches Jahrbuch* 1958, 82-88.
- Halbertsma, H., 1959: De cultuur van het noordelijk kustgebied, *Antiquity and survival* 2, 178-197.
- Halbertsma, H., 2000 (1982): *Frieslands Oudheid*, Groningen.
- Heather, P., 1998: Disappearing and reappearing tribes, in W. Pohl/H. Reimitz (eds), *Strategies of distinction. The construction of ethnic communities, 300-800*, Leiden etc. (The transformation of the Roman world 2), 95-112.
- Hedeager, L., 1992: *Iron-Age societies. From tribe to state in northern Europe 500 BC to AD 700*, Oxford/Cambridge (Mass.).
- Heidinga, H.A., 1987: Zwischen Friesen, Franken und Sachsen. Einige Bemerkungen zur Gruppenbildung im frühen Mittelalter in den Niederlanden, *Studien zur Sachsenforschung* 6, 55-71.
- Heidinga, H.A., 1997: *Frisia in the first millennium. An outline*, Utrecht.
- Henderikx, P.A., 1987: *De benedendelta van Rijn en Maas. Landschap en bewoning tot ca. 1000*, Hilversum (Hollandse studiën 19).
- Hiddink, H.A., 1999: *Germaanse samenlevingen tussen Rijn en Weser. 1ste Eeuw voor – 4de eeuw na Chr.*, Amsterdam (unpublished PhD, University of Amsterdam).
- Hines, J., 1995: Focus and boundary in linguistic varieties in the North-West Germanic continuum, *Friesische studien* 2, 35-62.
- Huizinga, J., 1954: Anthropologische beschouwingen naar aanleiding van enige skeletvondsten uit het begin der jaartelling in Westergo (Fr.), *Berichten van de Rijksdienst voor het Oudheidkundig Bodemonderzoek* 5, 50-76.
- Huizinga, J., 1955: Friezen uit het begin der jaartelling, *Nederlands tijdschrift voor geneeskunde* 98, 3396-3397.
- Knol, E., 1993: *De Noordnederlandse kustlanden in de Vroege Middeleeuwen*, Groningen.
- Künzel, R.E./D.P. Blok/J.M. Verhoeff, 1989² (1982): *Lexicon van Nederlandse toponiemen tot 1200*, Amsterdam.
- Kuhn, H., 1966: Die ältesten Namensschichten Frieslands, *Philologia Frisica* 4, 20-32.
- Lafaurie, J., 1959-1960: Le trésor d'Escharen, Pays Bas, *Revue numismatique* 652, 153-210.
- Lebecq, S., 1983: *Marchands et navigateurs Frisons du Haut Moyen Age*, Lille (2 vols.).
- Lund, A.A., 1991: Versuch einer Gesamtinterpretation der Germania des Tacitus, in W. Haase (ed.), *Aufstieg und Niedergang der römischen Welt* II.33, Berlin/New York, 1956-1988.
- Meffert, M., 1998: Ruimtelijke relaties in het Oer-IJ-estuarium in de Romeinse IJzertijd met nadruk op de Assendelver polders, Amsterdam.
- Nicolay, J., 1998: *Goudvondsten uit het Noord-Nederlandse terpengebied. Politieke, religieuze en sociale aspecten van import, circulatie en depositie van goud*, Groningen (unpublished MA thesis, University of Groningen).
- Nielsen, H.F., 1994: Ante-Old Frisian: a review, *Nowele* 24, 91-136.

- Platenkamp, J.D.M., 1993: Tobelo, Moro, Ternate. The cosmological valorization of historical events, *Cakalele. Maluku research journal* 4, 61-89.
- Pohl, W., 1991: Conceptions of ethnicity in Early Medieval studies, *Archaeologia Polona* 29, 39-49.
- Pohl, W., 1997: Ethnic names and identities in the British Isles. A comparative perspective, in J. Hines (ed.), *The Anglo-Saxons. From the migration period to the eight century. An ethnographic perspective*, San Marino, 7-32.
- Pol, A., in prep. *Production and circulation of Merovingian coins in the northern periphery of the Frankish empire and the adjacent Frisian territories, 6th-7th centuries.*
- Prou, M., 1892: *Les monnaies merovingiennes*, Paris.
- Russchen, A., 1967: *New light on dark-age Frisia*, Drachten.
- Russchen, A., 1970: Keramiek en ritueel in de vijfde eeuw, *It beaken* 32, 121-132.
- Seebold, E., 1995: Wer waren die Friesen - sprachlich gesehen?, *Friesische studien* 2, 1-18.
- Stiles, P.V., 1995: Remarks on the 'Anglo-Frisian' thesis, *Friesische studien* 2, 177-220.
- Taayke, E., 1988: Terpenaardewerk uit de ijzertijd en de Romeinse tijd, M. Bierma/A. Clason/E. Kramer/G.J. de Langen (eds), *Terpen en wierden in het Fries-Groningse kustgebied*, Groningen, 50-60.
- Taayke, E., 1996: *Die einheimische Keramik der nördlichen Niederlande, 600 v. Chr. bis 300 n. Chr.*, Groningen.
- Theuws, F., 1988: *De archeologie van de periferie: studies naar de ontwikkeling van bewoning en samenleving in het Maas-Demer-Schelde gebied in de vroege middeleeuwen*, Amsterdam.
- Van Bree, C., 1997: *Een oud onderwerp opnieuw bekeken: het Ingewoons*, s.l.
- Van der Velde, H.M., 1997: Katwijk: Zanderij Westerbaan, in R.M. van Heeringen en M. Meffert (eds), *Archeologische kroniek van Holland*, Amersfoort, 403.
- Van Giffen, A.E., 1936: Der Warf in Ezinge, Provinz Groningen, Holland, und seine westgermanischen Häuser, *Germania* 20, 40-47.
- Van Regteren Altena, H.H./H.A. Heidinga, 1977: The North Sea region in the Early Medieval period (400-950), in B. van Beek/R.W. Brandt/W. Groenman-van Waateringe (eds), *Ex horreo*, Amsterdam, 47-67.
- Vos, P.C./R.M. van Heeringen, 1997: Holocene geology and occupation history of the province of Zeeland (SW-Netherlands), *Mededelingen Nederlands Instituut voor Toegepaste Geowetenschappen TNO* 59.
- Vos, P.C., 1999: The Subatlantic evolution of the coastal area around the Wijnaldum-Tjitsma terp, in J.C. Besteman/J.M. Bos/D.A. Gerrets/H.A. Heidinga (eds), 33-72.
- Waterbolk, H.T., 1991: Ezinge, *Reallexikon der germanischen Altertumskunde* 8, 60-76.
- Waterbolk, H.T., 1995: Patterns of the peasant landscape, *Proceedings of the Prehistoric Society* 61, 1-31.
- Wenskus, R., 1977² (1961): *Stammesbildung und Verfassung. Das Werden der frühmittelalterlichen gentes*, Köln/Wien.
- Wolfram, H., 1994: *Das Reich und die Germanen: zwischen Antike und Mittelalter*, Berlin.
- Woltering, P.J., 1996-1997: Occupation history of Texel, III: The archaeological survey, palaeogeography and settlement patterns, *Berichten van de Rijksdienst voor het Oudheidkundig Bodemonderzoek* 42, 209-364.
- Wood, I., 1994: *The Merovingian kingdoms*, London/New York.

Index of names and places

This index contains only ancient names whereby no distinction has been made between the substantive and adjectival form of a name. In cases where a modern place name was arguably intended as the equivalent of an ancient name, it has been included, as have modern names referring to sites of ancient sanctuaries (whose ancient names have remained unknown). On the other hand, 'Greeks' and 'Romans' have not been taken into account nor have the personal names figuring in the appendix of Derks's paper. As is inevitable in a volume that thematically spreads across the Graeco-Roman world, authors sometimes have spelled names of the same people or places differently. No attempt has been made to homogenise spelling nor to differentiate between the precise loci of the distinct spelling forms.

Ethnonyms

- Abantes 41, 49
Achaians 1, 11, 13, 16, 26, 47, 52, 53, 214
Aedui 221, 222, 235, 236, 264, 329
Aeolians, see Aiolians
Aethogurgenses 195
Africans 194, 195, 199, 201, 210
Agrippinenses 163, 251, 257, 259–261, 263, 265, 268, 269
Aigosages 125
Aiolians 40, 44, 46, 47, 49, 51–53, 58, 61, 64, 70, 214
Akkadians 103
Angivarii 207, 208, 212
Anglo-Saxons 321, 332
Antiochenes 112
Apulians 157, 163
Aramaeans 82, 103
Argives 90
Arverni 221, 222, 235
Azanes 18, 25, 26
Babylonians 58, 61, 103, 106–111, 113
Bacaudae 289, 311, 316
Baetasii 261, 262, 269
Baniubae 192
Baquates 193, 194
barbarians, barbaric 50, 88, 90, 92, 137, 153, 191, 193, 196, 208, 215, 223–226, 229, 231, 291, 296, 301, 303, 329
barbarophonos 45
Basques 329
Batavians 1, 2, 5, 8, 197, 208, 213, 219, 220, 226–236, 240–260, 263–266, 268–270
Bavares 193, 202
Berbers 195
Bituriges 214
Britons 94, 252, 253, 329
Bructeri 212
Burgundians 284, 293
Calabri 147, 148, 163
Canninefates, Cannifates 207, 208, 246, 268, 329
Carnutes 264
Carolingians 316, 331, 333
Celts 118, 119, 123, 124, 126, 127, 130, 131, 141, 144, 214, 225, 272
Chaldaeans 103
Chamavi 212
Chatti, Catti 210, 242, 329
Chauci, Cauci 325, 328, 329
Cherusci 96, 208, 210, 229
Cugerni 234, 235, 260–263, 268, 269
Danes 329
Dauni 155
Dorians 11, 13, 37, 40, 44, 45, 47–51, 54, 58, 59, 66, 70, 71, 73, 74, 214
Eburones 4, 235
Egyptians 71, 103, 180, 210
Epirotes 158, 163
Etruscans 33, 62, 145, 147, 214
foederati 287, 311
Franks 190, 236, 284, 290, 291, 293, 309, 311, 322, 327, 328, 330–333
Frisians, Frisii 5, 197, 207, 255, 321–323, 325–332
Frisiavones 323
Frissones 329
Frusiones 329
Gaetulians 191, 195, 198
Galatai 119, 121, 128, 130
Galatians 2, 3, 94, 117–125, 127–130, 134–138, 140, 143
Gallograeci 117, 118
Gambrivii 214
Garamantes 190, 191
Gauls, Galli 1, 118, 172, 210, 212, 214, 225, 226, 235, 244
Germans, Germani 6, 208, 210, 212, 214, 244, 245, 251, 253, 256, 260–62, 277, 284, 289, 311, 328, 329
Germanic 3, 6, 200, 220, 226, 229–235, 245, 252, 255, 287–290, 292, 293, 296–302, 304, 305, 308–311, 313, 325, 328
Goths 190, 193, 290, 329
Gotones 212
Hellenes, Hellènes 47, 50, 70, 86, 90, 92, 93, 102, 103
Herminones 214
Hermunduri 208
Heruli 331
Hispanus, -i 244
Hittites 50, 55, 131, 134
Ingaevones 214
Ionians 1, 8, 37–44, 46, 47, 49–55, 57–60, 65, 66, 68–74, 214
Istaeuvones 214
Jews 102, 103, 106, 112, 167, 168, 170, 178
Jubaleni 192
Jutes 326, 329, 331
Karians 40, 43, 45, 46, 49, 57–61, 63, 65, 68, 71
Kassites 103
laeti 287, 311
Laguatan 190, 194, 196
Lingones 255, 264
Lydians 8, 40, 41, 45, 46, 50, 58, 59, 61–64, 67, 69–71, 73, 74, 214
Lykians 49, 69
Macaes 193
Maccabees 167, 171
Macedonians 4, 5, 103, 105–107, 109, 112, 113, 137, 158, 159, 211, 214, 328
Marsi 214
Masaesyli 190, 192
Massinissenses 191, 195
Massyles 190, 191

- Mauri 5, 190, 191, 193–196, 198, 199, 201, 202
 Medes 91, 92
 Medinisses 195
 Merovingians 6, 191, 222, 295, 314, 328, 329, 331
 Messenians 69, 212
 Messapians 147, 148, 150, 160, 161, 163
 Milesians 41, 52, 59, 60, 62, 64, 66, 68, 70, 71
 Musulamii 191, 192, 197, 198
 Musuni 197
 Mysians 50
 Nababes 193
 Nahanarvali 213
 Nasamonies 4, 190, 193
 Nicives 196, 197
 Numidians 190, 191, 193, 198
 Pagogurgenses 195
 Palestinianians 102, 170, 171, 176, 181
 Pamphyloi 47
 Parrhasians 25
 Parthians 106
 Persians 41, 42, 58, 59, 62, 63, 66, 70, 73, 74, 86–90, 103, 104, 133, 181, 195, 210, 211
 – Persian wars 8, 37, 39, 73, 74, 88–91, 94, 97, 102
 Pessinountioi 130
 Pharusii 195
 Phoenicians 67, 171, 175, 180, 195, 213
 Phrygians 50, 58, 68, 127–131, 138
 Psylli 190
 Quinquegentanei 193
 Raeti 244, 254
 Remi 5, 221, 235, 255
 Rhigosages 125
 Sabellic 155
 Sallentini 147, 148
 Samnite 145
 Sarmatians 213
 Saxons 94, 326, 328–330, 332
 Scythians 174, 175, 210, 225
 Semnones 232
 Sicambri 331
 Spaniards (see also Hispanus) 112
 Suburbures 196, 197
 Suebi, Suevi 213, 214, 232, 329, 331
 Sugambri (see also Sicambri) 331
 Sumerians 103
 Sunuci 261
 Sybarites 60, 62
 Syrians 106, 171, 179, 182
 Taouianoii 132
 Tektosages 117, 119, 123–125, 128–130
 Tencteri 234, 255
 Thracians 61, 90, 103, 244, 253–255
 Tolistobogians 117–119, 123–125, 127, 128, 130–133, 135
 Toutobodiaci 125
 Traianenses 259, 262, 263, 265, 266, 268, 269
 Treveri 121, 214, 252, 260, 263–265, 268–270
 Trokmoi 117, 119, 123, 124, 130, 132
 Tuihanti 254
 Tungri 248, 252, 255, 260, 265, 268–270
 Turdetanoi 212
 Ubians 6, 163, 234, 235, 245, 251, 255, 260–263, 266–269
 Vandal 190
 Vandilii 214
 Vangiones 252
 Varni 329, 330
 Visigoths 94, 331
 Voturi 125
- Theonyms (including names of heroes and mythical ancestors)**
- Achaios 47
 Achilleus 94
 Aeneas, Aineidai 53, 201, 221, 222, 266–268
 Ahura Mazda 104
 Aiolos 47, 53
 Alaisiagae 254
 Alci 213
 Amazons 89, 90, 93, 94
 Ammon 191, 195, 196
 Anahita 104
 Andraimon 52, 53
 Andromeda 180
 Aphrodite 46, 175, 179, 180
 Apollo 41, 64, 66, 68–72, 89, 157, 182
 Arados 171
 Artemis 13, 64, 66, 68, 134, 175, 182
 – Artemision 55, 56, 63, 64, 67
 Atargatis 179
 Athena 64, 66–68, 89, 93, 175, 180, 212
 – Pallas 64
 – Poliouchos 64
 – Promachos 90, 91, 93, 94
 Baal Hammon 201
 Bacchus 175
 Baduhenna 207
 Boros 54
 Cacus 232
 Capitoline triad 172, 201
 Castor 213
 Centaurs 90
 Cepheus 180
 Dagon 171, 181
 (Dea) Roma, Roma and Augustus 129, 130, 133, 135, 267
 Dea Syria 173
 Derketo 179
 dii Ingirozoglezim 195
 Dionysos 64, 173, 175–178
 Dioscuri 175, 214
 Dōros 47, 180
 Frigas 327
 Galates 225
 genius Vanisnesi 195
 Geryones 225, 228
 Glaukos 53
 Gurzil 194, 195
 Haeva 233
 Hellen 47, 102, 214
 Hera 13, 64, 66, 68, 70
 – Heraion 52, 63, 64, 67, 70
 Herakles 25, 47, 48, 178, 182, 212, 234
 Heraklid(s), Herakleidai 13, 47–49, 53, 90
 Hercules 8, 9, 89, 183, 191, 195, 220, 222–236, 266, 267
 – Magusanus 222, 227–236, 253, 254
 – Melquart 181, 182, 191, 195
 Io 182
 Iōn 47, 52
 Iphigenia 175
 Janus 94
 Juno Caelestis 201
 Jupiter 173, 195, 207
 Kodros 53, 54, 89
 Kybele (Kubaba) 68, 130, 131, 134, 135
 Liber Pater 175
 Mannus 214, 220
 Marduk 105, 106
 Marnas 180–182
 Mars 207, 220–223, 226, 229, 231, 235, 266, 267, 269
 – Camulus 221
 – Thingsus 254
 – Ultor 266
 Marsyas 173
 Menestheus 89
 Minerva 94, 134, 255
 Minos 181, 182
 Mitra 104
 Nehalennia 254
 Neleus, Neleids 51–54
 Nestor 52
 Ocelas 212
 Odysseus 212, 224, 232
 Orestes 175
 Perseus 158, 159, 180
 Pollux 213
 Poseidon 16, 52, 65, 178–180
 – Helikonios 49, 52, 60, 65, 70, 72
 Priam 268, 327
 Proteus 13
 Pylades 175
 Remus 221, 266
 Rhadamanthus 181
 Romulus 221, 222, 266
 Saturn 201
 Scythes 225
 Tanit 201
 Theseus 89
 Tlepolemos 48, 53
 Tuisto 214
 Tyche 172, 176, 178–180, 182

Vagdavercustis 254
 Xouthos 47, 52
 Zeus 27, 56, 64, 70, 110, 131, 173, 176,
 178, 180-182
 - Akraios 175
 - Bennios 133
 - Bussumaros 134
 - Bussurigios 133, 134
 - Casios 182
 - Narenos 133
 - Olympios 170, 173, 175
 - Sarnendenos 133
 - Mykaleus 66
 - Souolibrogenos 132, 134
 - Taenos 129
 - Taouianos 129
 - Tavianos 129, 131, 134

Place names

Aelia Capitolina 8, 168, 170, 171, 173,
 175, 183
 Aetos, sanctuary 16, 17
 Aigion 16, 23, 26, 28
 Alesia 225
 Alexandria (Egypt) 102, 103, 106, 110,
 156, 180, 181
 Alexandria (on the Persian Gulf) 4,
 103, 112
 Alexandria (Kandahar) 106
 Alexandria (Iskenderun) 106
 Ankyra 8, 117, 123-125, 128-130, 132-
 136, 138
 Ano Mazoraki, sanctuary 13, 26
 Antioch (on the Orontes) 106, 114,
 170
 Antiochia ad Hippum 179
 Antiochia in Pisidia 132
 Apamea 106
 Apulum 134
 Argos 13, 23, 24, 162
 Arpi 155-157, 163
 Ascalon 171, 178, 179, 183
 Asciburgium 224, 232
 Assesos 56, 67, 71
 Athens 16, 22, 46, 49, 52-55, 59, 73,
 74, 85-90, 93, 94, 96, 97, 106, 109,
 129, 137
 Augusta Treverorum 263, 268
 Azotus 171, 181
 Babylon 4, 5, 103-114
 Banasa 195, 197
 Beth Shean, see Scythopolis
 Brundisium, Brindisi 6, 148, 150, 151,
 154, 156-164
 Caesarea-Cherchel 191
 Caesarea Maritima 168, 169, 171, 172
 Canusium, Canosa 146, 155-157, 161,
 163
 Carthage 157, 190, 194, 195, 200
 Castra Herculis 224

Çatallar Tepe, see Mykale
 Charax, see Alexandria on the Persian
 Gulf
 Chios 37, 38, 40, 43, 44, 49, 56, 59, 64,
 67-70
 Colijnsplaat, sanctuary 254
 Corinth 15-17, 21, 25, 28, 109
 Delos 42, 65, 67-72, 151, 153, 156,
 157, 162
 Delphi 65, 67, 89, 157, 159, 162
 Didyma 63, 64, 66-68
 Diospolis (Lydda) 170, 180
 Dodona, sanctuary 158, 159
 Dura Europos 178
 Ekkobriga 123, 132, 134
 Elateia 22
 Elst, sanctuary 222, 225-227, 230, 232,
 235, 236, 247
 Empel, sanctuary 8, 222-224, 227, 228,
 230-232, 234, 235, 247
 Emporiae 112
 Ephesos 38, 53, 55-57, 59, 63, 64,
 66-69, 71, 114, 137
 Erythrai 38, 49, 56, 59, 61, 64, 68
 Flevum 207
 Gabba Hippeon 171
 Gadara 181
 Gaza 168, 170, 171, 180-183
 Gela 14
 Gordion 118, 123, 124, 126-128, 130,
 132
 Gravisca 40, 43
 Güzelçamlı, see Mykale
 Halikarnassos 37, 38, 45, 54, 56, 70,
 122
 Helike 52, 65
 Hippo Regius 193, 194
 Isthmia 16
 Jaffa 180
 Jerusalem 112, 114, 167, 170, 173, 178,
 179
 Kalettepe, see Mykale
 Kessel 222, 227, 228, 230, 232, 235
 Klaros 38, 56-64, 67, 68
 Klazomenai 38, 43, 46, 56, 57, 70
 Knidos 66, 70, 71, 161, 257
 Knossos 22, 41, 181
 Koinon
 - of the Dorians: see Triopion
 - of the Epirotes 158
 - of the Galatians 128-130, 135, 136,
 138
 - of the Ionians: see Panionion
 - of Phokis 18
 Kolophon 38, 4, 51-53, 58-64, 70
 Kommos 20
 Lambaesis 201
 Laodicea on the Sea 106, 109
 Lecce, Lupiae 149, 150
 Lefkandi 22
 Lepcis Magna 200
 Lousoi 13

Magnesia on the Maiandros 38, 58, 59,
 64, 66, 70
 Mantinea 27
 Marathon 85-98
 Massalia 64
 Megara 23
 Megara Hyblaea 16
 Melie 53, 60, 65, 66
 Metapontion 13, 52, 155
 Miletos 38, 41, 46, 49, 52, 53, 55-57,
 59, 60, 63, 64, 67-71
 Mykale 49, 53, 58-60, 65, 66, 70-72
 Myous 38, 59
 Mytilene 43, 53, 59, 70, 73
 Naukratis 43, 61, 64, 70, 71
 Neapolis (in Samaria) 170-174, 178,
 183
 Nippur 103, 104
 Noviomagus (Nijmegen) 230, 247,
 259, 260, 268, 270
 Nysa (see also Scythopolis) 174-176,
 178
 Olympia 17, 27, 29, 67, 131
 Oria 148, 154, 155, 159, 163
 Oropos 26
 Ostia 180, 181
 Otomatik Tepe, see Mykale
 Panionion 18, 37, 38, 52, 55, 60, 65,
 66, 70, 72
 Penteskouphia 25
 Pergamum 93, 94, 118, 119, 123, 125,
 131, 132, 136, 137, 159, 162
 Persis 104
 Pessinus (see also Pessinountioi) 123,
 128, 130-132, 135, 138
 Pherai 24
 Phokaia 38, 41, 43, 56-58, 61, 64, 66,
 68, 70, 112
 Pithekoussai 17, 22
 Plataea 87, 88, 92, 95, 96
 Priene 38
 Pylos 29, 51-53
 Raphia 178
 Ravenna 329
 Rhodos 42, 43, 48, 53, 55, 56, 70, 161
 Rome 6, 8, 94, 114, 119, 131, 136,
 157-163, 171, 180, 196, 199, 208,
 214, 220-225, 229-232, 235, 242-
 246, 248, 251, 153-55, 259, 261, 262,
 265-268, 270
 Rudiae 148, 149, 159, 160, 163
 Samos 37, 38, 40, 41, 44, 46, 49, 52, 56,
 58-61, 63, 66-68, 70, 71
 Sardes 53, 56, 58, 61, 66, 68, 114
 Scythopolis 171, 173-180, 183
 Sebaste 170-173
 Seleucia (in Pieria) 106
 Seleucia (on the Euphrates) 103
 Seleucia (on the Tigris) 4, 103, 106-
 111, 113, 114
 Sepphoris (Diocaesarea) 168, 178, 182
 Smyrna 38, 46, 49, 51, 56, 59, 64, 67,

68, 70
 Souliobriga 132
 Sparta 13, 23, 48, 51, 63, 74, 89, 92,
 109, 212
 Susa 106
 Taranto 148, 150-152, 155, 161
 Tavium (see also Taouianoï) 8, 123,
 124, 129-132, 134-136, 138
 Teos 38, 43, 53, 56, 61, 63, 66, 70
 Thubursicum Numidarum 198
 Tiberias 170
 Tibiscum 249
 Timgad 201
 Tiryns 13
 Tolastochora 123, 132
 Triopion 40, 66, 70
 Troy 45, 49, 50, 53, 56, 201, 267, 268
 - Trojan heroes 212, 266
 - Trojan myths 212, 220-225, 235,
 267, 268, 327, 330
 - Trojan war 41, 49, 50, 89, 102, 162
 Tyre 171, 179, 181, 182
 Ulpia Noviomagus, see Noviomagus
 Urso 267
 Uruk 103, 113
 Vanisnesium 192, 195
 Vindia 132
 Vindolanda 213, 243, 252, 256, 264
 Volubilis 191

Other geographical names

Achaia 13, 15, 16, 26, 28, 29, 42, 52,
 53, 65
 Aegira 26
 Aigina 70
 Aiolis 60, 61
 Argolid 13, 21, 23, 42
 Arkadia 13, 18, 21-23, 25, 26, 28
 Attika 13, 42, 44, 47, 53, 59, 69, 71, 74
 Azania 16, 26, 28
 Babylonia 58, 71, 103-106, 108, 111
 Batuvua 331
 Boiotia 25, 42
 Britannia 329
 Brittia 329
 Crete, Krete 15, 17, 20, 23, 48, 154,
 181
 Cyprus 17, 42, 68
 Cyrenaica 190
 Decapolis 173, 174, 179
 Dodekanesos 48, 50, 53, 59
 (Ionian) Dodekapolis 37-39, 52, 53, 65
 Elis 26-28
 Epiros 42, 158, 163
 Etruria 14, 43
 Euboia 17, 20, 22, 41-44, 47, 49, 59,
 69, 71
 (Dorian) Hexapolis 45
 insula Batavorum 249, 270, 331
 Kyklades 42-44, 49, 57, 59, 69, 71, 72

Lakonia 23
 Latium 17
 Lesbos 42, 49, 59
 Lydia 46, 59, 61, 67, 69, 73
 Lykia 49, 69
 Magna Graecia 13, 153
 Messenia 28
 pagus Condrustis 254
 pagus Vellavus 254
 Phoenicia 22, 43, 181
 Phokis 18, 20, 23, 28
 Sicily 13, 17, 54, 61, 92
 Toxandria 309, 311, 331
 Triphylia 18

Personal names

Aldgisl 328, 333
 Alexander (the Great) 4, 102, 103, 105-
 107, 110, 112, 114, 128, 328
 Alkaïos of Mytilene 62, 73
 Alyattes, Lydian king 67, 70
 Amasis, pharaoh 67, 70
 Antiochus I (Soter) 106, 107, 124
 Antiochus II (Theos) 107, 113
 Antiochus III (the Great) 106, 108,
 109, 112, 125
 Antiochus IV (Epiphanes) 106-112,
 175
 Antiochus V (Eupator) 108, 111
 Arkas 25
 Arminius 208, 229
 Arsinoë II 156
 Arthaphernes 86
 Assurbanipal 104
 Attalos I 125
 Attalos II 93, 136, 137
 Audulfus 330
 Childeric 295, 304, 314
 Chilperik 329
 Cimon 88, 89
 Clovis 295, 314, 331
 Cruptorix 7, 207-210, 212, 215
 Darius 86
 Datis 86
 Deiotaros I Philorhomaïos 119, 131,
 132, 134, 136, 137
 Deiotaros II Philopator 119
 Deiotaros Philadelphos 137
 Demetrius II Nicator 108, 175
 Q. Ennius 6, 159-164
 Eumenes, king of Pergamum 159, 162
 M. Fulvius Nobilior 160
 Gabinius 175
 Germanicus 207, 208, 224, 266, 268
 Gyges, Lydian king 59, 70
 Herodicus of Babylon 101, 110, 112,
 113
 Hygelac 329
 Juba I 191
 Juba II 191, 195

Julius Caesar 112, 191, 221, 235
 Julius Civilis 231, 255
 Kroisos 41, 58, 61, 64, 67, 170
 Cn. Manlius Vulso 118, 127, 131
 Massinissa 190, 191, 195, 196
 Masuna 202
 Miltiades 87-89, 93
 Mithradates VI Eupator 118, 119, 132
 Mithridates II 109
 Nebuchadnezzar 105, 106, 113
 Necho II, pharaoh 67
 Nikomedes 122, 123
 Peisistratos 17
 - Peisistratidai 53, 54
 Peppin 331
 Pericles 91, 92
 Psammetichos I 558, 61
 Psammetichos II 43
 Qorinthios 16, 25
 Redbad 328, 333
 Remigius 331
 Segestes 208
 Segimundus 208
 Seleucus I Nicator 105-107, 110
 Seleukos, son of Ariston 176
 Shapur I 94
 Solon 42, 46, 64, 170
 Tacfarinas 191, 198
 Tarquinius Priscus 214
 Themistocles 93
 Theodoric 202
 Thessalos 17
 Varus (P. Quinctilius -) 207
 Willibrord 331
 Xerxes 87

List of contributors

Prof. Jos Bazelmans
Rijksdienst voor Archeologie, Cultuurlandschap en Monumentenzorg
Postbus 1600
NL – 3800 BP Amersfoort
j.bazelmans@racm.nl

Prof. N. Belayche
Centre Gustave Glotz
UMR 8585
2 rue Vivienne
F – 75002 Paris
n.belayche@wandoo.fr

Dr. Jan Paul Crielaard
VU University Amsterdam
Faculty of Arts
De Boelelaan 1105
NL – 1081 HV Amsterdam
jp.crielaard@let.vu.nl

Dr. Ton Derks
VU University Amsterdam
Faculty of Arts
De Boelelaan 1105
NL – 1081 HV Amsterdam
amj.derks@let.vu.nl

Prof. Hans-Joachim Gehrke
Deutsches Archäologisches Institut
Podbielskiallee 69-71
D – 14195 Berlin
praesident@dainst.de

Prof. Catherine Morgan
Director of the British School at Athens
(Professor of Classical Archaeology, Kings College London)
Souedias 52
106 76 Athens
Greece
director@bsa.ac.uk

Prof. Nico Roymans
VU University Amsterdam
Faculty of Arts
De Boelelaan 1105
NL – 1081 HV Amsterdam
ngam.roymans@let.vu.nl

Prof. R.J. Van der Spek
VU University Amsterdam
Faculty of Arts
De Boelelaan 1105
NL – 1081 HV Amsterdam
rj.vander.spek@let.vu.nl

Prof. Karl Strobel
Institut für Geschichte
Abteilung für Alte Geschichte und Altertumskunde
Universitätsstraße 65-67
A-9020 Klagenfurt
karl.strobel@uni-klu.ac.at

Prof. Frans Theuws
Amsterdams Archeologisch Centrum
Turfdraagsterpad 9 (gebouw BG 1)
NL – 1012 XT Amsterdam
theuws@uva.nl

Prof. Dick Whittaker (†)
Churchill College
Cambridge

Prof. Greg Woolf
University of St. Andrews
School for Greek, Latin and Ancient History
Swallowgate, St. Andrews, Fife, KY16 9AL
United Kingdom
gdw2@st-andrews.ac.uk

Prof. Douwe Yntema
VU University Amsterdam
Faculty of Arts
De Boelelaan 1105
NL – 1081 HV Amsterdam
dg.yntema@let.vu.nl