

## 1st Politeia International Conference Proceedings "Europe at the Crossroads: Leadership, Challenges and State of Play"

Sidiropoulos, Symeon (Ed.); Tzagkarakis, Stylianos Ioannis (Ed.); Kritas, Dimitrios (Ed.)

Veröffentlichungsversion / Published Version

Konferenzband / conference proceedings

### Empfohlene Zitierung / Suggested Citation:

Sidiropoulos, S., Tzagkarakis, S. I., & Kritas, D. (Eds.). (2021). *1st Politeia International Conference Proceedings "Europe at the Crossroads: Leadership, Challenges and State of Play"*. Athens: Hellenic Association of Political Scientists (HAPSc). <https://doi.org/10.2139/ssrn.3784083>

### Nutzungsbedingungen:

Dieser Text wird unter einer CC BY Lizenz (Namensnennung) zur Verfügung gestellt. Nähere Auskünfte zu den CC-Lizenzen finden Sie hier:

<https://creativecommons.org/licenses/by/4.0/deed.de>

### Terms of use:

This document is made available under a CC BY Licence (Attribution). For more information see:

<https://creativecommons.org/licenses/by/4.0>

Under the Auspices of H.E. the President of the Hellenic Republic,  
Mr. Prokopios Pavlopoulos



**POLITEIA: AN INTERNATIONAL  
CONFERENCE OF POLITICAL SCIENTISTS**

# 1st Politeia International Conference Proceedings

**“Europe at the Crossroads:  
Leadership, Challenges and State of Play”**

Symeon Sidiropoulos,  
Stylianos Ioannis Tzagkarakis,  
Dimitrios Kritas

ATHENS 2021



Hellenic Association of Political Scientists

Electronic copy available at: <https://ssrn.com/abstract=3784083>

1<sup>st</sup> POLITEIA International Conference

**Europe at the Crossroads: Leadership, Challenges and State of Play**

Zappeion Megaron - Athens, 27-29 September 2019

**1<sup>st</sup> POLITEIA CONFERENCE PROCEEDINGS**

**Editors:**

**Symeon Sidiropoulos** is a Political Scientist. He is the President of the Hellenic Association of Political Scientists (HAPSc). Also, he is a Scientific Associate at the Laboratory of Health Economics and Management (LabHEM) of the University of Piraeus, an Associate Researcher at the Center for Human Rights (KEADIK), University of Crete, and an associated researcher at the Public Policy and Administration Research Laboratory (LABDIPOL) of University of Crete.

**Dr. Stylianos – Ioannis Tzagkarakis** (BA, MA, PhD) is Teaching Fellow and Post-doctoral researcher at the University of Crete. He is researcher of the Centre for Political Research and Documentation (KEPET) of the University of Crete, General Secretary of the Hellenic Association of Political Scientists (HAPSc) and Member of the Steering Committee of the ECPR Political Culture Standing Group.

**Dimitrios Kritas** is a Political Scientist (BA, MA, EMBA-c, PhD-c). He is the Deputy President of the Hellenic Association of Political Scientists (HAPSc), he holds the position of the Field Manager at Public Policy and Administration Research Laboratory (LABDIPOL) of University of Crete, and he is a Researcher of the Center for Political Research and Documentation (KEPET) of the University of Crete and a Scientific Associate at Laboratory of Health Economics and Management (LabHEM) of the University of Piraeus.

**Publisher:** Hellenic Association of Political Scientists (HAPSc).

The Hellenic Association of Political Scientists (HAPSc) is a Non-Profit, Civil Society, Scientific Association. During the last 12 years it has develop multiple partnerships such as it is: a) a member of the United Nations Academic Impact (UNAI), b) in Special Consultative Status with the United Nations Economic and Social Council (UN – ECOSOC), c) associated with the United Nations Department of Global Communications (UN – DGC), d) a member of the International Political Science Association (IPSA), e) a member of the Academic Council on the United Nations System (ACUNS), f) a representative of Greece in the International Coalition for the Responsibility to Protect (ICRtoP), g) a partner organization in the annual Peace Week conference held in Geneva at the UN facilities (Geneva Peace Week – Palais des Nations). The main organizers of the conference are the Geneva Peacebuilding Platform, the Graduate Institute of Geneva, the United Nations (United Nations Geneva Office) supported by the Government of Switzerland.

Copyright © 2021 Hellenic Association of Political Scientists (HAPSc)

Disclaimer: The editors and publishers will have no legal responsibility for any errors or omissions that may be in this publication. The publisher makes no warrants implied, with respect to the material contained here.

This work is licensed under a Creative Commons Attribution 4.0 International license (CC BY 4.0). This license allows you to share, copy, distribute and transmit the work; to adapt the work and to make commercial use of the work providing attribution is made to the editors (but not in any way that suggests that the endorse you or your use of the work).



Attribution should include the following information:

Sidiropoulos, S., Tzagkarakis, S-I, Kritas, D. (2021), *1<sup>st</sup> POLITEIA International Conference Proceedings. Europe at the Crossroads: Leadership, Challenges and State of Play*, Athens: Hellenic Association of Political Scientists

Further details about CC BY licenses are available at: <http://creativecommons.org/licenses/by/4.0/>.

Further details about the Politeia International Conference are available at: <https://www.politeia-conf.com/>.

Further details about the Hellenic Association of Political Scientists (HAPSc) are available at: <https://www.hapsc.org/>.

All external links were active at the time of the publication.

**ISBN: 978-618-82982-2-4**

Printed in Athens, Greece for the Hellenic Association of Political Scientists.

1<sup>st</sup> Edition  
February, 2021



Hellenic Association of Political Scientists

Email : [sec@hapsc.org](mailto:sec@hapsc.org)

Phone : +30 2103645390

Address: Voukourestiou 38, Kolonaki, Athens, Postcode: 10673

## Table of Contents

Prologue by the President of the Hellenic Association of Political Scientists (HAPSc).....	6
Prologue by the President of the Scientific Committee of the POLITEIA Conference .....	8
Introduction by the editors.....	9
TOPIC 1: EU GOVERNANCE AND LEADERSHIP .....	10
1.1. Policy making and implementation in times of crisis from a public governance perspective: The cases of Cyprus, Greece, Ireland and Portugal.....	11
	<i>Panos Liverakos</i>
1.2. The sense of “democratic deficit” in the European Union .....	21
	<i>Christos Papageorgiou, Panagiotis Liargovas, Zacharias Dermatis</i>
TOPIC 2: EU DEFENCE AND INTERNATIONAL SECURITY .....	49
2.1. The security challenges that the EU is facing in cyberspace.....	50
	<i>Eleni Kapsokoli</i>
TOPIC 3: EU INTEGRATION, POLITICS AND GOVERNANCE ISSUES .....	64
3.1. Regional Integration in the EU; The Community Method and the Open Method of Coordination .....	65
	<i>Ilektra Simitsi</i>
TOPIC 4: ISSUES OF ENERGY AND SUSTAINABLE DEVELOPMENT .....	82
4.1. A game theoretic analysis of energy security in the Eastern Mediterranean .....	83
	<i>Vasileios D. Papakostas, Elissavet E. Bekou, John A. Paravantis</i>
4.2. Carbon Pricing: recent developments in European Union .....	95
	<i>Christos Bentsos</i>
4.3. Sustainable Development and the European Union: From Policy Making in the Field of Application .....	111
	<i>Zoi Karanikola, Georgios Panagiotopoulos</i>
TOPIC 5: POLITICAL ORIENTATION, POPULISM AND EUROSCEPTICISM .....	120
5.1. Conceptual and empirical analysis of modern Euroscepticism: The cases of France, United Kingdom and Italy .....	121
	<i>Georgios Nastos</i>
TOPIC 6: MIGRATION – REFUGEE CRISIS AND EU POLICIES.....	138
6.1. Sovereignty, Europeanism and borders: how migration is challenging concepts and patterns .....	139
	<i>Giovanna Campani</i>
6.2. Pro- and anti-migrant mobilisations in polarised Greece: Solidarians, raid battalions, activists, and self-mobilized citizens .....	150
	<i>Theodoros Fouskas</i>
6.3. Parents’ mobilizations during the refugee crisis. A brief overview of the Oraiokastro and Samos cases .....	168
	<i>Maria Siamaga, George Siakas</i>
6.4. Global constitutionalism theory towards a better judgment of the asylum and immigration policies.....	176
	<i>Dani - Georgia Koutsopoulou</i>
6.5. Refugees’ social and economic integration prospects in Greece: A case study in Lesvos and Crete islands.....	195
	<i>Dimitrios Kotroyannos, Stylianos Ioannis Tzagkarakis, Apostolos Kamekis, Georgia Dimari, Emmanouil Mavrozacharakis</i>
6.6. The Changing Face of the Common European Asylum System: The Uncertain Future and Challenges for Refugees’ Integration in the European Union.....	209
	<i>Sibusisiwe Bulala Kelly</i>

TOPIC 7: FINANCE AND INVESTMENTS .....	225
7.1. Financial contagion and volatility spillover: An exploration into crude oil future market and 3Y, 4Y and 5Y CDS markets.....	226
	<i>Konstantinos Tsiaras</i>
TOPIC 8: ISSUES OF EDUCATION POLICY AND SOCIAL COHESION .....	240
8.1. At the Dawn of the Fourth Industrial Revolution: Challenges and Opportunities of Artificial Intelligence in Education with the view at achieving the Sustainable Development Goals.....	241
	<i>Pavlos Petidis</i>
8.2. The pseudo-dilemma of Autonomy versus Accountability in Higher Education Policy Reforms in Greece .....	260
	<i>Vaia Papanikolaou, Yiannis Roussakis, Panagiotis Tzionas</i>
8.3. The challenges of forging a new policy for an inclusive religious education in Greece .....	276
	<i>Zoe Michalopoulou</i>
8.4. From inclusive to equal European public spheres: bringing the theories of feminism and agonistic pluralism back in.....	281
	<i>Aristeidis Myriskos</i>
TOPIC 9: PUBLIC POLICIES IN EDUCATION, HIGHER EDUCATION & TRAINING.....	289
9.1. Greece as an International Hub for Higher Education: Opportunities, challenges and recommendations for Greece in the International Student Market (ISM).....	290
	<i>Cheryl Novak</i>
9.2. European educational governance: policy learning and the teaching profession .....	297
	<i>George Pasiias, Antonia Samara</i>
TOPIC 10: REGIONAL DEVELOPMENT AND GOVERNANCE IN THE EU AND GREECE .....	310
10.1. Regional Governance and Modularized Training-Reskilling towards Policy Improvement: The Case of the Research Project “Governance, Sustainability and Regional Innovation” (KA 4289) .....	311
	<i>Maria Drakaki, Stylianos Ioannis Tzagkarakis, Apostolos Kamekis, Kostas A. Lavdas, Dimitrios Kotroyannos, Nikos Papadakis</i>
TOPIC 11: MEDIA AND THE DIGITAL ERA .....	322
11.1. The TV commercials of the Greek bailout referendum 2015 .....	323
	<i>Aggeliki Flora Thanopoulou</i>
TOPIC 12: HEALTHCARE POLICIES.....	334
12.1. Total Quality Management and leadership: a way to improve healthcare services in Greece.....	335
	<i>Dimitrios Kritas, Symeon Sidiropoulos, Dimitrios Kakouris</i>
12.2. Health Communication: Opportunities and Challenges .....	346
	<i>Konstantina Briola</i>
TOPIC 13: GOVERNANCE AND POLITICS IN GREECE.....	359
13.1. Organizational size and IT innovation adoption: A scrutiny of the relationship between size and e-Government maturity in Greek municipalities, through a citizen/service-oriented maturity model .....	360
	<i>Michail Tsafantakis</i>
13.2. The Greek party system in crisis: From the ideological context to the pro-memorandum vs antimemorandum discourse.....	391
	<i>Konstantina Kotsiopoulou</i>
13.3. Public governance and the management of wicked public problems .....	407
	<i>Maria Rammata</i>
13.4. Digital Barometer for Public Org’s and Agencies .....	419
	<i>Dimitrios I. Panopoulos</i>

13.5. Social Security, Social Welfare in Greece and Europe in the Crisis Period, 2009-2019.....	437
	<i>Konstantinos Memos</i>
BOOK OF ABSTRACTS.....	449
APPENDIX – The program of the conference	

## **Prologue by the President of the Hellenic Association of Political Scientists (HAPSc)**

I am honored to welcome you to our 1<sup>st</sup> POLITEIA International Conference Proceedings. In this edition is included papers from the presentations, the booklet of our 1<sup>st</sup> POLITEIA International Conference and the book of abstracts.

The first POLITEIA International Conference of Political Scientists took place at Zappeion Megaron in Athens, the capital of Greece, organized by the Hellenic Association of Political Scientist under the Auspices of H.E. President of the Hellenic Republic, Mr. Prokopios Pavlopoulos. Furthermore, it was held with the support of the European Commission (Representation in Greece), by the United Nations Regional Information Centre (UNRIC) for Greece and Cyprus and it was included in those actions using the emblem of the United Nations Academic Impact. Last but not least, this conference organization was supported by 21 partners such as academic institutions, academic laboratories, scientific associations, societies and youth associations.

In this Conference there were more than 150 distinguished speakers, such as Ministers, MEPs, MPs and Regional Governors, Professors, Researchers and International Experts from Universities, Research Centers, Institutes and International Organizations, who participate to an open dialogue mainly focused on Europe. The Conference language was both in Greek and in English and we provided live interpretation. The title of the Conference was “*Europe at the Crossroads: Leadership, Challenges and State of Play*”. We organized it around a series of topics about EU challenges and prospects for the future, in which among other was including EU Governance and Regional Development, Public Policy and Administration, Foreign Policy and International Relations, Politics, Sustainable Development and Energy Politics, Social Cohesion, Inequalities and Social Policy, Labour Market, macro-Economic Policy and Financial Markets and the role of EU to response to the multiple crisis of the last decade such as Economic and Refugee Crisis, EU integration etc.

The focus on Political Science combined with a structured interdisciplinary approach, provides an evidence – based framework for the multiparametric analysis of both the European state of play and the rising challenges at the supranational, national and regional level. Through the promotion of Civil Society engagement, and by maintaining cooperation with international and national institutions, the Hellenic Association of Political Scientists (HAPSc) was aimed to both cultivate the critical spirit of its members and acquire a more decisive role in the formulation of political decisions. Intending to expand its constant contribution to public debates through its scientific approaches, HAPSc organized this Conference, in which the aspiration was to formation into an interdisciplinary think tank platform, through which cooperation over current scientific and political issues can be possible. Acknowledging the multidimensional challenges that the European Union is faced with and being aware of the multidisciplinary character of those issues, the first International Conference “POLITEIA” aims to reflect both on the European Current Affairs and the constantly increasing challenges arising in the international system.



I wholeheartedly would like to thank again all the sponsors and partners of our Conference for their contribution, which was vital for the conduction of “POLITEIA”. Especially, I would like to thank Ms. Katerina Nafplioti Panagopoulos, the Athens Medical Group, the Hellenic Association of Entrepreneurs (EENE), the TRUE Catering, the BMW Sfakianakis Company, and the Antonios and Ioannis Angelicoussis Foundation.

*Symeon Sidiropoulos,*

President of the Hellenic Association of Political Scientists,

President of the Organizing Committee of the “POLITEIA” International Conference

## **Prologue by the President of the Scientific Committee of the POLITEIA Conference**

Within the framework of the POLITEIA International Conference, more than 150 speakers (including Ministers, MEPs, MPs and Regional Governors, as well as Professors, Researchers and International Experts from Universities, Research Centers, Institutes and International Organizations) have participated in an open (yet structured) dialogue, mainly focused on Europe. The Conference, entitled “Europe at the Crossroads: Leadership, Challenges and State of Play”, was organized around a series of topics including EU Governance and Foreign Policy, International Relations and Politics, Sustainable Development and Energy Politics, Citizenship, Social Cohesion, Inequalities and Social Policy, Public Policies, Policy Making and Implementation, Public Administration, Labour Market(s), Regional Development and Governance, macro-Economic Policy and Financial Markets, EU response to the Refugee Crisis, EU integration and current challenges (i.e. Euro-scepticism and populism), etc. The focus on Political Science, combined with a structured interdisciplinary approach, provided an evidence – based framework for the multiparametric analysis of both the European state of play and the rising challenges at the supranational, national and regional level. Thus, I would like to congratulate the HAPSc for this important initiative and further to cordially thank, on behalf of the Scientific Committee, all the participants and guests of the POLITEIA International Conference, for their exceptional scientific papers, which formulate the present Proceedings of the Conference. Due to the speakers-participants of the Conference, the POLITEIA Conference Proceedings provide an interdisciplinary academic forum for discussion on the key topics- issues related to Europe.

***Nikos Papadakis,***

Professor & Director of the Center for Political Research and Documentation,  
Department of Political Science, University of Crete.

Deputy Director of the University of Crete Research Center for the Humanities, the Social and Education Sciences (UCRC).

Member of the Scientific Board of the National Centre of Public Administration and Local Government (EKDDA).

## Introduction by the editors

It is a great honour to introduce you the proceedings of the 1<sup>st</sup> POLITEIA International Conference “Europe at the Crossroads: Leadership, Challenges and State of Play”. We are grateful to all participants and especially to those that send us their full papers. The included papers are in a very high academic level and cover a wide range of topics, which was actually the main aim of the conference.

In this book of proceedings the reader will find interesting analyses about several contemporary aspects. We have separated the volume into thirteen topics, based on the focus of the papers which were presented in the conference. The papers of the first three topics analyse aspects concerning the EU governance and leadership, the EU defence and international security as well as opinions about the EU integration, politics and governance issues. In the fourth topic the contributors focus on issues of energy and sustainable development, which are crucial to the stability in Europe and its periphery and in the fifth topic the focus is on Euroscepticism and populism, which still concern the European political arena. The sixth topic focus on a very important contemporary European problem; the immigration and refugee crisis, with several contributions presenting novel research and important outcomes. Topic seven focuses on finance and investments issues while topics eight and nine on educational policy issues and their connection with social cohesion. Topic ten focuses on regional development and governance in the EU and Greece while topic eleven on media in the digital era. Finally, topic twelve analyses healthcare policy issues while topic thirteen closes the volume with issues concerning governance and politics in Greece. At the end of the volume you could find the full book of abstracts as well as the programme of the conference.

We believe that the contributions included in this volume offer special and novel insights on several contemporary issues and they will be interesting for every reader as they are characterised by novelty and clarity.

The editors,

*Symeon Sidiropoulos,*

*Dr. Stylianos – Ioannis Tzagkarakis,*

*Dimitrios Kritas*

**TOPIC 1: EU GOVERNANCE AND LEADERSHIP**

## 1.1. Policy making and implementation in times of crisis from a public governance perspective: The cases of Cyprus, Greece, Ireland and Portugal

*Panos Liverakos<sup>1</sup>*

### **Abstract**

This paper considers the role and contribution of the governance systems and institutional structures in the four countries of interest and how these systems and structures responded to the most recent economic and financial crisis. It first presents briefly the type and mix of policies these countries adopted and implemented in their attempt to alleviate the adverse effects of the economic and financial crisis of 2008. It then assesses whether the quality of governance systems and institutional structures played a role in the degree to which the mix of policies adopted and implemented were successful. It appears that the policy responses to the crisis may have been strongly influenced by the state of sophistication of institutional structures and quality of governance systems in place at the start, and throughout the crisis.

**Keywords:** Governance, policy implementation, financial crisis, Greece, Eurozone

### **Introduction**

Another global economic and financial crisis, steadily brewing over the first decade of the 21<sup>st</sup> Century, climaxed in the latter part of 2008 and burst into the open due to the collapse of Lehman Brothers in September of the same year. This unfortunate development had a domino effect, not only on other financial institutions globally but also on numerous countries around the world, though in varying degree and magnitude. Among those countries were Cyprus, Greece, Ireland and Portugal; included in this study. They are all members of the European Union, all situated in its periphery. All are also members of the Eurozone,<sup>2</sup> having joined the single currency bloc at different times between 1998 and 2014.<sup>3</sup> Furthermore, all are parliamentary republics, holding regular elections to choose their governments. Greece and Portugal have had experience with totalitarian rule prior to joining the European Union, as they were ruled by military dictatorships, both returning to democratic status in 1974. Ireland and Cyprus had been under occupation by Great Britain, before they claimed their independence, in 1921 and 1960 respectively.

---

<sup>1</sup> Technical Advisor, Astana Civil Service Hub, UNDP Kazakhstan. Email: panos@liverakos.info

<sup>2</sup> The eurozone, officially called the euro area, is a monetary union of 19 European Union (EU) member states that have adopted the euro (€) as their common currency and sole legal tender.

<sup>3</sup> In 1998, eleven member states of the European Union had met the euro convergence criteria, thus the eurozone came into existence on 1 January 1999. Two of the countries of this study - Ireland and Portugal - were among the member states, which joined the eurozone. Greece qualified in 2000 and it was admitted on 1 January 2001, before the physical currency was introduced on 1 January 2002. Latvia followed on 1 January 2014 and Cyprus on 1 January 2008. As of 1 January 2015, 19 out of the 28 member states of the European Union are also members of the eurozone.

**Table 1: Data of the selected countries**

Country	Area (sq. km.)	Population	E.U. Member since	Eurozone Member since
Cyprus	9,251	1,172,458	2004	2008
Greece	131,957	10,775,557	1981	2001
Ireland	70,273	4,832,765	1973	1999
Portugal	92,090	10,813,834	1986	1999
TOTAL	303,565	27,594,614	-	-
<i>Eurozone</i>	<i>2,852,518</i>	<i>334,570,000</i>	-	-
<i>E.U.</i>	<i>4,475,757</i>	<i>513,000,000</i>	-	-

Source: Eurostat (2016)

All four countries are relatively small in terms of size and population. They cover 9% of the Eurozone area and their population accounts for 9% of the total. Similarly, their contribution to the overall economic activity of the Eurozone, measured by gross national product, amounts to a considerably small percentage of the total GDP<sup>4</sup> of the Eurozone. In 2015, the combined GDP of these countries represented 5.5% of the total; lower by 1% from 2008 when their share stood at 6.5% of the total. This decrease is the result of their GDP contraction between 2008 and 2015, by 12.89%. The biggest drop in monetary terms, 35.18%, was registered in Greece, followed by Cyprus (7.2%), Portugal (3.4%) and Ireland with a small drop of 0.8%. In contrast, the GDP for the Eurozone increased by 4.7% and for the whole EU by 13.2%.

**Table 2: GDP (2008 versus 2015)**

Country	GDP (million euro)	Eurozone share (%)	GDP (million euro)	Eurozone share (%)	Eurozone share % change	GDP % change
	<b>2008</b>		<b>2015</b>		<b>2008-15</b>	<b>2008-15</b>
Cyprus	18,768	0.19	17,506	0.17	-0.02	-7.20
Greece	242,096	2.51	179,080	1.77	-0.74	-35.18
Ireland	186,870	1.94	185,411	1.84	-0.11	-0.78
Portugal	178,872	1.86	173,044	1.71	-0.15	-3.36
<b>4-country total</b>	<b>626,606</b>	<b>6.51</b>	<b>555,041</b>	<b>5.49</b>	<b>-1.02</b>	<b>-12.89</b>
<i>Eurozone</i>	<i>9,627,011</i>		<i>10,103,472</i>			<i>4.71</i>
<i>EU</i>	<i>12,986,407</i>		<i>14,703,852</i>			<i>13.22</i>

Source: Eurostat (2016)

### Policy choices and adjustment programmes for coping with the crisis

Governments may select an array of responses in addressing economic and financial challenges. They may engage in fiscal tightening through public spending cuts, tax reforms, structural restructuring or currency devaluations; however, the latter is not applicable in the case of these four countries as they all share a common currency. Conversely, governments may choose to boost their economies through public sector spending,

<sup>4</sup> The gross domestic product (GDP) is the monetary value of all the finished goods and services produced within a country's borders in a specific time period, usually calculated on an annual basis. It includes all of private and public consumption, government outlays, investments and exports less imports that occur within a defined territory.

increased production, lower taxation, etc. Furthermore, approaches to resolving problems arising from a crisis may range from more non-interventionist with minimal government involvement, to interventionist policies that are driven by the state.

It seems that the four countries included in this study opted for policy responses that were primarily fiscally oriented, e.g. public spending cuts, higher taxation; and structural restructuring policies, e.g. public sector reform, downsizing, privatisation, market liberalisation, red tape reduction, social security and pension reform, taxation reform. The main goals of these policies were to stabilise the countries' battered economies, reduce their needs for borrowed funds and eventually balance their budgets. It was also expected that such policies in conjunction with downward wage adjustments would make their economies more productive and thus more competitive to withstand the negative effects of the crisis in the absence of other conventional tools such as devaluation.

The core policy choices adopted by all four countries were substantially influenced and, often, guided by the European Commission (EC), the European Central Bank (ECB) and the International Monetary Fund (IMF), through the Adjustment Programmes agreed with each respective country.<sup>5</sup> All four countries negotiated a 3-year adjustment programme between March 2010 and June 2011, with the exception of Greece that entered into two more 3-year adjustment programmes with the third programme ending formally in August 2018.

**Table 3: Adjustment programmes in Eurozone**

Country	Adjustment Agreement time frame	Period in years	Aid amount in € billion
Cyprus	05/2013 – 03/2016	3	8
Greece	03/2010 – 08/2018	6 (8)	350
Ireland	12/2010 – 12/2013	3	85
Portugal	06/2011 – 06/2013	3	78

Wide variations have been noted not only in the duration of the adjustment programmes but also in policy outputs and outcomes following their implementation. Thus, it is worth exploring the factors that could account for such variations, especially with respect to outcomes. It appears that what played a role in implementation were, first, the differences among the four countries in the degree of sophistication of their institutional frameworks, in place prior to the crisis; and, second, their differences with respect to their degree of integration into the world economy.

### **Do governance structures and institutional frameworks matter?**

---

<sup>5</sup> Although the policies of the adjustment programmes were mainly dictated by the lenders, each country had considerable freedom to decide which mix of policies it would implement.

Research on the role of institutional frameworks and governance structures in coping with crises suggests that countries which have made more progress in establishing sound governance structures and institutional frameworks and they have built better institutions supportive of a flexible market economy are better able to adjust to the impact of external shocks (EBRD, 2019). In other words, those countries that have made considerable progress in building sound and durable governance frameworks and institutional structures and have developed better market mechanisms are better able to adjust to the impact of external shocks than others. Consequently, it seems that a correlation exists between the quality of governance structures in place and the degree of effectiveness of the adjustment programmes implemented during the past decade as an antidote to the economic and financial crisis. In this context, the main hypotheses of this study are that: (i) quality of governance and the capacity of government institutions matter in overcoming the negative effects of a crisis whether it be political, economic or financial; and (ii) quality of governance structures in place have influenced the degree of effectiveness of the adjustment programmes implemented during the past few years.

Therefore, particular emphasis is placed on analysing the degree of sophistication of the institutional structures and governance frameworks in place prior to the manifestation of, and during, the crisis in all four countries in order to find out how these may have affected the implementation of the adjustment programmes and their intended outputs and outcomes. This choice is based on the assumption that any shortcomings in the quality of governance systems and institutional structures may be significant impediments in confronting rapidly and decisively the problems associated with the crisis; as well as that in many instances they may have exasperated the intensity of such problems and may have further complicated the process of resolving them.

In validating our assumption, several indicators are utilised to assess the degree of sophistication of the governance systems in each of the four countries. They range from the World Bank Governance Indicators, measuring the quality of governance along eight dimensions that constitute good governance;<sup>6</sup> to the Transparency International Corruption Perception Index, which ranks countries by their perceived levels of public sector corruption, as determined by expert assessments and opinion surveys (Transparency International, 2018).

However, before we turn to the presentation of the selected indicators that reveal the degree of sophistication of the governance systems and the quality of institutional frameworks in each of the four countries, it is worth looking at the level of their human development to assess the overall development status of each of these countries and not only their economic growth. For this, the Human Development Index (HDI) is utilised; a composite index measuring average achievement in three basic dimensions of human development – a long

---

<sup>6</sup> Good governance has eight major characteristics: it is participatory, consensus-oriented, accountable, transparent, responsive, effective and efficient, equitable and inclusive and it adheres to the rule of law (World Bank, 2018).



and healthy life, knowledge and a decent standard of living – effectively demonstrating the level of development of a country.<sup>7</sup>

According to the data, it seems that all four countries enjoy a high level of human development, which has progressively increased over the past two decades, effectively putting them among the top 40 most prosperous countries in the world, well above the world average.

**Figure 1: Human Development Index (1990-2017)**

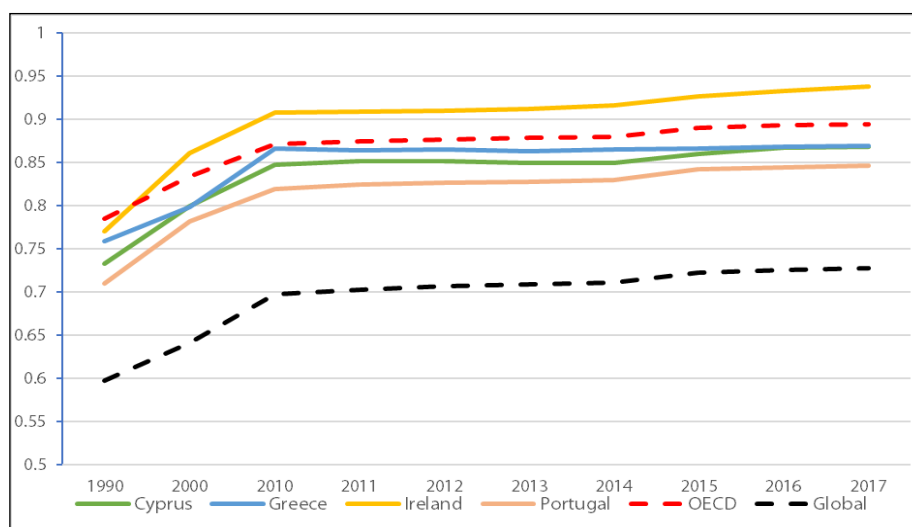

Source: Human Development Index (2018)

We now turn to several indicators that reveal the quality of governance in each of the four countries, which are in turn utilised as explanatory variables in discerning the quality of their governance structures and how this has fared in each in implementing their respective adjustment programmes.

The first such indicator is the government effectiveness index. This composite index captures perceptions of the quality of public services, the quality of the civil service and the degree of its independence from political pressures, the quality of policy formulation and implementation, and the credibility of the government's commitment to such policies. In sum, it indicates how well government institutions are functioning and how

<sup>7</sup> The health dimension is assessed by life expectancy at birth, the education dimension is measured by mean of years of schooling for adults aged 25 years and more and expected years of schooling for children of school entering age. The standard of living dimension is measured by gross national income per capita. The HDI uses the logarithm of income, to reflect the diminishing importance of income with increasing GNI. The scores for the three HDI dimension indices are then aggregated into a composite index using geometric mean. The HDI can also be used to question national policy choices, asking how two countries with the same level of GNI per capita can end up with different human development outcomes. These contrasts can stimulate debate about government policy priorities. However, the HDI simplifies and captures only part of what human development entails. It does not reflect on inequalities, poverty, human security, empowerment, etc (UNDP, 2019).

effective they are in dispensing their mandate. A strong effectiveness index takes the value of 2.5 and a weak one takes the value of -2.5.

By looking at the data, one notices that Greece's index value (0.72) was the lowest among the four countries at the beginning of the time period under study (2005) and it consistently remained so, deteriorating further over the years reaching the value of 0.31 at the end of the time period (2017), well below than the values of the other three countries at the same time. This is in contrast with Ireland that had a value of 1.74 in 2005 and a value of 1.29 in 2017, or with Cyprus that it had a value of 1.16 in 2005 and 0.92 in 2017, or with Portugal that started with a value of 1.06 and it ended with a value of 1.33 at the end of the same period.

**Figure 2: Government effectiveness index (2005-2017)**

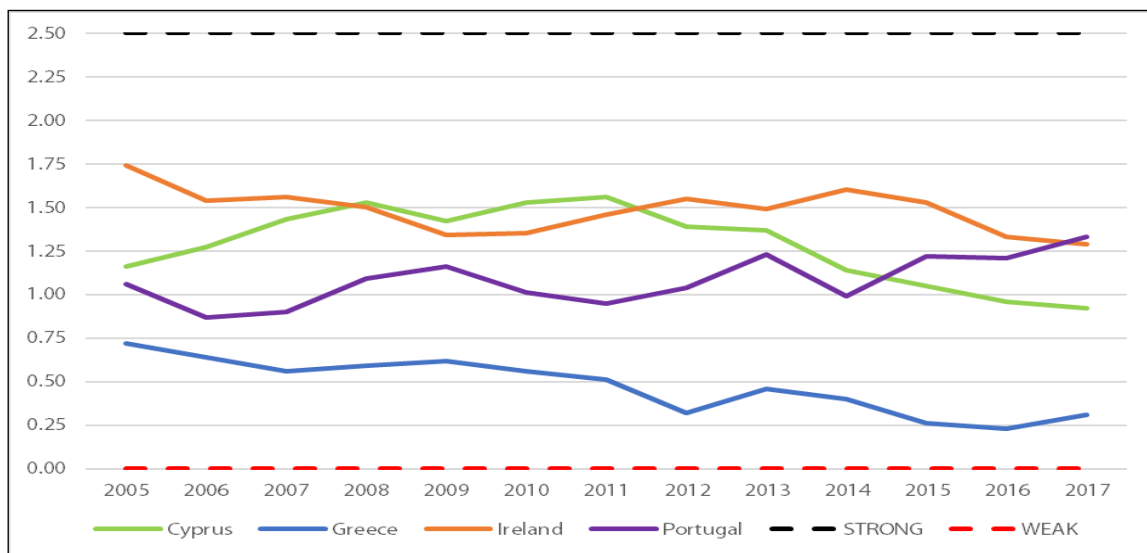

Source: World Bank (2018)

Thus, it seems that the government system could not cope with the pace of change required by the adjustment agreements as it could not devise policies that could effectively tackle the formidable problems and challenges that countries were facing, and they needed to react to. However, it seems that some did better than others. In fact, Portugal fared quite well finishing with a value higher at the end of the period than that at the beginning. The other two, Cyprus and Ireland fared quite well losing only a small part of their original values, whereas Greece witnessed a dramatic drop, indicating that its government effectiveness was not sufficient to implement the policies prescribed in its adjustment programme.

The next index, regulatory quality index, captures perceptions of the ability of the government to formulate and implement sound policies and regulations that permit and promote private sector development, including the promotion of market liberalisation and red tape reduction. The data indicate that Ireland has a rather robust

regulatory system in place in promoting a market economy with as few burdens as possible, which may be translated into an economic environment that is flexible and adaptable to changing circumstances and turns.

Conversely, Cyprus and Portugal have had an average regulatory system in place, which eventually deteriorates somewhat over the time period under study. For Greece, however, a similar pattern emerges as in the case of the government effectiveness index. Not only the value of this index was the lowest among the four countries at the beginning of the time period, but it also deteriorated dramatically by 2017. This observation may be interpreted that the country did not manage to implement effective policies aiming at market liberalisation and red tape reduction; and in general, to promote private sector development to counteract public sector shortcomings in coping with the crisis.

**Figure 3: Regulatory quality index (2005-2017)**

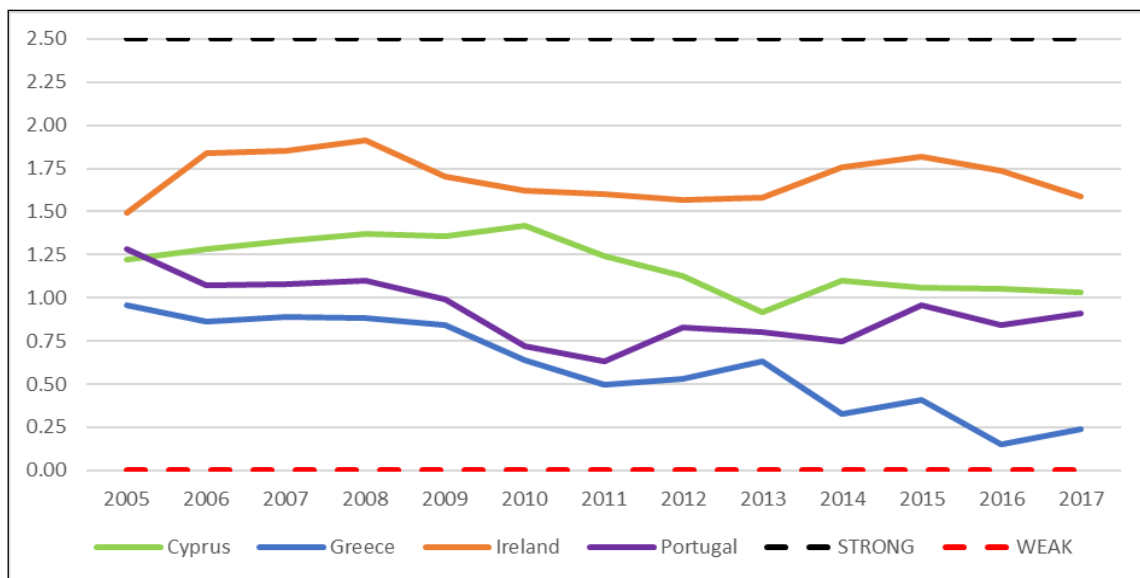

Source: World Bank (2018)

In fact, there is still a multitude of regulations that impose an unfair burden on business, on the ease of starting and closing a business and one the ease of registering property among other. Furthermore, there is still widespread government intervention in the economy through the dominance of some state owned enterprises. Moreover, a strict employment law does not provide for flexibility in hiring and firing and the tax system is rather complex; and the banking system is not as strong as it should; as it is burdened with a considerable number of non-performing loans (NPL).

The following index, the rule of law index, captures perceptions of the extent to which agents have confidence in and abide by the rules of society, and in particular the quality of contract enforcement, property rights, the police, and the courts, as well as the likelihood of crime and violence.

The data indicate that Ireland has had a superior system in place safeguarding the rule of law from the beginning of the time period under study to date (1.60 in 2005; 1.43 in 2017). Furthermore, the data also indicate that Portugal has had a fair system in place safeguarding the rule of law all along the time period under scrutiny (1.23 in 2005; 1.13 in 2017). Moreover, Cyprus also had a fair systems in place during the same period (0.89 in 2005; 0.88 in 2017).

**Figure 4: Rule of Law Index (2005-2017)**

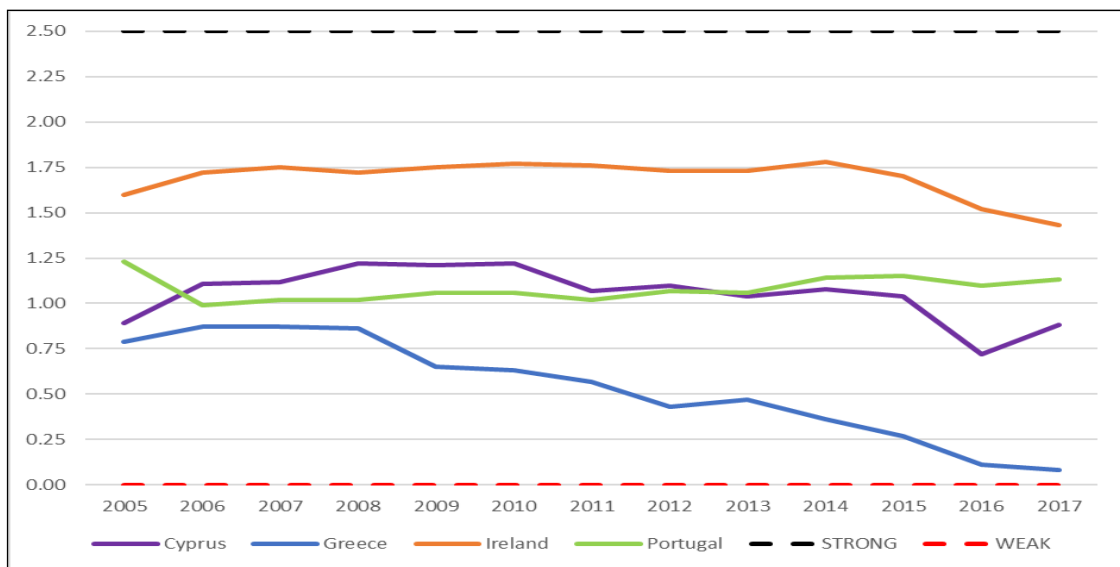

Source: World Justice Project (2018)

However, in the case of Greece, a similar pattern, as in the case of the previous indicators discussed, emerges. The country, again, seems to score the lowest values among the four not only at the beginning of the time period but also at the end (0.79 in 2005; 0.08 in 2017).

This indicates that its systems for safeguarding the rule of law were not only at a low level to begin with, but such systems deteriorated over time, and they remain rather weak. This is a crucial issue in the implementation of the adjustment programmes as adherence to the rule of law is essential to holding governments, businesses and civil society organisations accountable for furthering the interests of the country, as well as attracting investors to commit resources in the country. In this case, investors would most likely think twice before investing in a country with such a low score on the rule of law index, as for example, property rights may be ill-defined and easily disputed and contracts may be difficult, cumbersome and time-consuming to enforce.

The last index utilised in this paper to demonstrate the quality of governance in each of the four countries included in the study is the control of corruption index, which captures the perceptions of the extent to which public power is exercised for private gain, including both petty and grand forms of corruption, as well as the

degree of “capture” of the state by elites and private interests, and by extension, who really influences the direction of policy making choices.

A similar pattern emerges in this case too. Ireland is at the top of the four countries with an index value of 1.59 in 2005 and 1.55 in 2017. Portugal follows with an index value of 1.07 in 2005 and 0.87 in 2017. Next is Cyprus with an index value of 0.91 in 2005 and 0.78 in 2017. Last is Greece with an index value of 0.36 in 2005 and -0.14 in 2017.

In fact, the data indicate that the index value for Greece turned negative from 2010 onwards until almost the end of the implementation of its third adjustment programme. Such values demonstrate that there exists grand and petty corruption at all levels of government, nepotism and cronyism in the civil service and the anti-corruption laws in place are not effective, to mention a few of the symptoms.

Such values also indicate that the government is not free from excessive bureaucratic regulation, registration requirements and other controls that increase the opportunities for corruption, effectively resulting to a situation where economic growth is hindered by increasing costs, lowering productivity and discouraging investment, as well as reducing confidence in public institutions, among other issues.

**Figure 5: Corruption Control Index (2005-2017)**

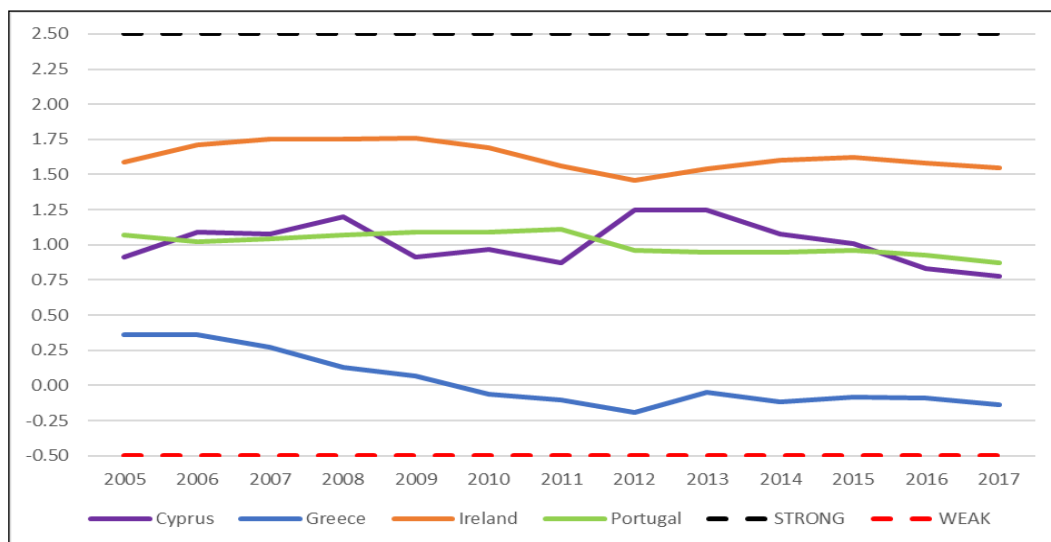

Source: Transparency International (2018)

## Discussion and conclusions

Considering the values of each country for each of the indicators presented in this paper, it seems that our hypotheses hold true to a significant extent. In sum, it seems that the ability to deal effectively with the challenges of the crisis was determined to a large extent by the quality and capacity of each country’s public

administration to design and formulate the most appropriate mix of policies and properly implement them within a pre-defined time frame so that they may yield maximum results.

This is most evident in the case of Greece that not only displayed the lowest values across all indicators at the beginning of the time period under study, when compared to the other three countries, but also that the values of these indicators consistently deteriorated over the time period covered by the study reaching dramatically low levels. This situation explains to a great extent the lack of capacity of government institutions and the existence of a weak governance system in coping with designing and implementing extraordinary policy measures aimed at tackling the negative effects of the crisis. This situation also reveals the inability of the governance system in place to think and act out of the box and implement policies that may have fared better in coping with the multiple negative effects of the crisis. Furthermore, this state of affairs was also compounded further, as low capacity of institutional structures hindered the implementation of even the simplest policy choices agreed with the lenders and which resulted in considerable delays in implementation, thus losing a major part of their expected impact.

In conclusion, it seems that: (i) quality of governance does matter in effectively implementing public policies in times of crises; (ii) capacity of government institutions matters in overcoming the negative effects of a crisis; and (iii) effectiveness of adjustment programmes is influenced by the government structures in place.

However, it seems that the situation in Greece was also influenced by other factors such as the high political fragmentation that was present in the country from the beginning of and throughout the peak period of the crisis. There was no consensus among the leading political forces in the country, resulting to formulating and implementing policies which were short-sighted conforming to the electoral cycle periods. Furthermore, more often than not such policies were hastily introduced to appease the lenders and satisfy the basic terms of the adjustment programme, so that the country can receive the next tranche of the financial aid that accompanied the adjustment programme in place.

## References

- EBRD (2019). *Transition Report 2019-20. Better governance, better economies*. Available at: <https://www.ebrd.com/transition-report> (Accessed: 20/11/2019).
- Transparency International (2018). *Corruption Perceptions Index*. Available at: <https://www.transparency.org/cpi2018> (Accessed: 11/10/2019).
- UNDP (2019). *Human Development Index (HDI)*. Available at: <http://hdr.undp.org/en/content/human-development-index-hdi> (Accessed: 12/10/2019).
- World Bank (2018). *Databank: Worldwide Governance Indicators*. Available at: <https://databank.worldbank.org/source/worldwide-governance-indicators> (Accessed: 15/10/2019).

## 1.2. The sense of “democratic deficit” in the European Union

*Christos Papageorgiou<sup>1</sup>, Panagiotis Liargovas<sup>2</sup>, Zacharias Dermatis<sup>3</sup>*

### Abstract

The sense of democratic deficit within the EU is a result of the prevailing view that EU governance lacks democratic legitimacy. Reports of a democratic deficit are growing, especially in times of economic or political crisis and uncertainty. In practice, the concept of democratic deficit expresses the distancing of EU institutions and decision-making centres from the citizens of the member states, while represents the functional distortions of its institutions, which become inaccessible to the average citizen, as their mode of operation is particularly complicated.

The views of many researchers differ on the existence and the type of the democratic deficit in the EU. Some of them, especially those who support intergovernmental cooperation, refuse its existence. Federalists argue that its institutions need to be reformed to achieve the required democratic legitimacy and functional transparency, with the consent of the citizens of the member states, leading in a form of federation. Eurosceptics argue that EE should reduce its arbitrary powers, which deprive the member states and their citizens of the ability of independent democratic functioning.

In the present work, an attempt is made to clarify the term, according to the different approaches for the way of legitimizing the EU political system, i.e. from the procedures (from the inputs) or from the obtained results (from the outputs), while the socio-psychological dimension of the issue is also investigated, which refers to the existence or not of a common European identity, and consequently to the possibility of the existence of a European Municipality. Furthermore, reference is made to the concept of "Europeanization", and its positive contribution to the creation of the aforementioned European unity.

It also explores in detail the sense of a democratic deficit in the EU, as reflected in the Eurobarometer, that is, whether European citizens believe they are satisfied with the level of democratic functioning of the EU and whether they feel they belong to a single European municipality. Finally, their interest in the functioning of the EU is being explored through their participation in the European elections, as well as their reactions through referendums for the ratification of treaties or their remain in the EU, while some explanations are provided for their stance, and finally, the obligation of European institutions is emphasized, in order to make European citizen informed in a timely and transparent manner.

**Keywords:** Democratic Deficit, European Union, European Municipality, Europeanization

<sup>1</sup> DProf Chemical Eng., PhD cand., Department of Economics, University of Peloponnese, Tripolis, Greece. Email: papagechrp@gmail.com.

<sup>2</sup> Professor of Department of Economics, University of Peloponnese, Tripolis, Greece.

<sup>3</sup> PhD, Laboratory staff, Department of Economics, University of Peloponnese, Tripolis, Greece

## 1.2. Η αίσθηση «Δημοκρατικού Ελλείμματος» στην Ευρωπαϊκή Ένωση

*Χρήστος Παπαγεωργίου, Παναγιώτης Λιαργκόβας, Ζαχαρίας Δερμάτης*

### Περίληψη

Η αίσθηση ύπαρξης δημοκρατικού ελλείμματος εντός της ΕΕ είναι αποτέλεσμα επικρατούσας άποψης ότι η διακυβέρνηση της ΕΕ στερείται δημοκρατικής νομιμότητας. Οι αναφορές για την ύπαρξη δημοκρατικού ελλείμματος διογκώνονται κυρίως σε περιόδους οικονομικών ή πολιτικών κρίσεων και αβεβαιότητας. Πρακτικά, το δημοκρατικό έλλειμμα ως έννοια εκφράζει την απομάκρυνση των θεσμών και των κέντρων λήψης των αποφάσεων της ΕΕ από τους πολίτες των κρατών-μελών, ενώ υποδηλώνει τις λειτουργικές στρεβλώσεις των οργάνων της, που καθίστανται απρόσιτα στο μέσο πολίτη, καθώς ο τρόπος λειτουργίας τους είναι ιδιαίτερα περίπλοκος.

Οι απόψεις πολλών ερευνητών διαφέρουν ως προς την ύπαρξη και το είδος του δημοκρατικού ελλείμματος στην ΕΕ. Ορισμένοι, κυρίως θιασώτες της διακυβερνητικής συνεργασίας, αμφισβητούν την ύπαρξή του. Οι φεντεραλιστές υποστηρίζουν ότι απαιτείται η μεταρρύθμιση των θεσμικών της οργάνων ώστε να αποκτήσουν την απαιτούμενη δημοκρατική νομιμότητα και λειτουργική διαφάνεια, με τη συναίνεση των πολιτών των κρατών-μελών, με κατάληξη σε μία μορφή ομοσπονδίας. Οι ευρωσκεπτικιστές υποστηρίζουν ότι θα πρέπει να μειώσει τις - κατ' αυτούς - αυθαίρετες εξουσίες της, οι οποίες στερούν από τα κράτη-μέλη και τους πολίτες τους τη δυνατότητα ανεξάρτητης δημοκρατικής λειτουργίας.

Στην παρούσα εργασία γίνεται προσπάθεια αποσαφήνισης του όρου, σύμφωνα με τις διαφορετικές προσεγγίσεις για τον τρόπο νομιμοποίησης του πολιτικού συστήματος της ΕΕ, δηλαδή εκ των διαδικασιών (εκ των εισροών) ή εκ του αποτελέσματος (εκ των εκροών), ενώ διερευνάται και η κοινωνικο-ψυχολογική διάσταση του θέματος, που αναφέρεται στην ύπαρξη ή όχι μιας κοινής ευρωπαϊκής ταυτότητας, και κατ' επέκταση στη δυνατότητα ύπαρξης ενός *Ευρωπαϊκού Δήμου*. Ακόμη, γίνεται η αναφορά στην έννοια του «εξευρωπαϊσμού», και της θετικής συμβολής του στη δημιουργία της προαναφερθείσας ευρωπαϊκής ενότητας.

Επίσης, διερευνάται διεξοδικά η αίσθηση ύπαρξης δημοκρατικού ελλείμματος στην ΕΕ, όπως αποτυπώνεται στο Ευρωβαρόμετρο, κατά πόσο δηλαδή οι ευρωπαίοι πολίτες πιστεύουν ότι ικανοποιούνται από το επίπεδο δημοκρατικής λειτουργίας της ΕΕ και κατά πόσο αισθάνονται ότι ανήκουν σε έναν ενιαίο ευρωπαϊκό δήμο. Τέλος, διερευνάται το ενδιαφέρον τους για τη λειτουργία της ΕΕ, μέσω συμμετοχής στις ευρωεκλογές, καθώς και οι αντιδράσεις τους μέσω δημοψηφισμάτων, για την επικύρωση συνθηκών ή την παραμονή στην ΕΕ, ενώ παρέχονται κάποιες εξηγήσεις για τη στάση τους και τονίζεται η υποχρέωση των ευρωπαϊκών θεσμών να ενημερώνουν έγκαιρα και διάφανα τον ευρωπαϊκό πολίτη.

**Λέξεις Κλειδιά:** Δημοκρατικό Έλλειμμα, Ευρωπαϊκή Ένωση, Ευρωπαϊκός Δήμος, Εξευρωπαϊσμός

### 1. Ορίζοντας το «Δημοκρατικό Έλλειμμα»

Η αίσθηση ύπαρξης δημοκρατικού ελλείμματος (democratic deficit) εντός της ΕΕ είναι αποτέλεσμα μίας επικρατούσας άποψης ότι η διακυβέρνηση της ΕΕ στερείται δημοκρατικής νομιμότητας. Οι αναφορές για την ύπαρξη δημοκρατικού ελλείμματος στην ΕΕ λαμβάνουν κατά καιρούς διαστάσεις, οι οποίες διογκώνονται κυρίως σε περιόδους οικονομικών ή πολιτικών κρίσεων και αβεβαιότητας. Πρακτικά το δημοκρατικό έλλειμμα ως έννοια εκφράζει την απομάκρυνση των θεσμών και των κέντρων λήψης των αποφάσεων της ΕΕ από τους πολίτες των κρατών-μελών, ενώ υποδηλώνει τις λειτουργικές στρεβλώσεις των οργάνων της ΕΕ που



τα καθιστά απρόσιτα στον μέσο πολίτη, καθώς ο τρόπος λειτουργίας τους θεωρείται από πολλούς ιδιαίτερα περίπλοκος.

Η αντίληψη της παρουσίας αυτής της αίσθησης ύπαρξης δημοκρατικού ελλείμματος από το μέσο πολίτη της ΕΕ απέκτησε ιδιαίτερη σημασία που απασχόλησε και εξακολούθει να απασχολεί τους θεσμούς της ΕΕ, αλλά και τις κυβερνήσεις των κρατών-μελών, ενώ λήφθηκε σοβαρά υπόψη κατά την κατάρτιση των συνθηκών, τόσο των ΕΚ όσο και της ΕΕ, με εμφανείς τις προσπάθειες μεταρρυθμίσεων των θεσμών της ΕΕ, ώστε να λειτουργούν με μεγαλύτερη διαφάνεια και λιγότερη γραφειοκρατία, καθώς και βελτίωσης του τρόπου λήψης των αποφάσεων ώστε αυτές να περιβάλλονται από την απαραίτητη δημοκρατική νομιμότητα.

Οι απόψεις πολλών ερευνητών διαφέρουν ως προς την ύπαρξη και το είδος του δημοκρατικού ελλείμματος στην ΕΕ. Ορισμένοι, κυρίως θιασώτες της διακυβερνητικής συνεργασίας, αμφισβητούν την ύπαρξή του, ενώ άλλοι υποστηρίζουν ότι αυτό υπάρχει και θα πρέπει να ληφθούν τα απαραίτητα μέτρα για να αντιμετωπιστεί. Ωστόσο, και οι τελευταίοι διαφοροποιούνται ως προς τους λόγους ύπαρξής του και ως προς τον τρόπο αντιμετώπισής του. Οι φεντεραλιστές υποστηρίζουν ότι η ΕΕ πρέπει να μεταρρυθμίσει τα θεσμικά της όργανα ώστε να αποκτήσουν την απαιτούμενη δημοκρατική νομιμότητα και λειτουργική διαφάνεια, με τη συναίνεση των πολιτών των κρατών-μελών, για την κατάληξη σε μία μορφή ομοσπονδίας, ενώ οι ευρωσκεπτικιστές υποστηρίζουν ότι η ΕΕ θα πρέπει να μειώσει τις εξουσίες της οι οποίες στερούν από τα κράτη-μέλη και τους πολίτες τους τη δυνατότητα δημοκρατικής έκφρασης.

### **1.1. Ιστορική αναδρομή και ορισμός του «Δημοκρατικού Ελλείμματος»**

Η ίδρυση των ΕΚ κατά τη δεκαετία του 1950 με τη μορφή τεχνοκρατικών και γραφειοκρατικών διοικητικών συστημάτων με απώτερο σκοπό τη σύγκλιση των πολιτικών των κρατών-μελών προς συγκεκριμένους τεχνοκρατικούς και οικονομικούς στόχους, όπως είναι αυτοί της συμπαραγωγής άνθρακα και χάλυβα (ΕΚΑΧ), της παραγωγής ατομικής ενέργειας (ΕΚΑΕ), της τελωνειακής ένωσης και της κοινής αγοράς (ΕΟΚ), δεν απαιτήσε εξ αρχής την ύπαρξη μίας αυστηρής δημοκρατικής έννομης τάξης, παρά την ύπαρξη και λειτουργία αρχικά της Κοινής Συνέλευσης και από το 1962 του Ευρωπαϊκού Κοινοβουλίου με μέλη διορισμένα από τα κοινοβούλια των κρατών-μελών.

Ιστορικά, ως πρώτη προσπάθεια ενίσχυσης της δημοκρατικής νομιμότητας στις ΕΚ, μέσω του Ευρωπαϊκού Κοινοβουλίου, υπήρξε η Έκθεση Vedel του 1971, της επιτροπής εμπειρογνομόνων υπό τον Georges Vedel, σχετική με την ενίσχυση των θεσμικών και δημοσιονομικών εξουσιών του Ευρωπαϊκού Κοινοβουλίου, μέσω της προοδευτικής αύξησης των νομοθετικών εξουσιών του, την εξασφάλιση πραγματικής αρμοδιότητας συναπόφασης με το Συμβούλιο των Υπουργών και την εκλογή των Ευρωβουλευτών με άμεση καθολική ψηφοφορία.

Ωστόσο, η έκφραση «δημοκρατικό έλλειμμα» θεωρείται ότι καταγράφηκε για πρώτη φορά το 1977 από τους Νέους Ευρωπαίους Φεντεραλιστές, στο Πρώτο Κεφάλαιο της Διακήρυξης των Νέων Ευρωπαίων Φεντεραλιστών (Jeunes Européens Fédéralistes [JEF] Manifesto), το οποίο συντάχθηκε από τον Richard

Corbett (European Parliament, 2008). Ακόμη, το 1979 ο όρος χρησιμοποιήθηκε από τον Βρετανό πολιτικό επιστήμονα David Marquand σε σχέση με το Ευρωπαϊκό Κοινοβούλιο, υποστηρίζοντας ότι αυτό υπέφερε από δημοκρατικό έλλειμμα, καθώς δεν εκλέχτηκε άμεσα από τους πολίτες των ΕΚ (Marquand, 1979), τονίζοντας ότι «*Το προκύπτει 'δημοκρατικό έλλειμμα' δεν θα ήταν αποδεκτό σε μια Κοινότητα που δεσμεύτηκε να τηρεί δημοκρατικές αρχές*».

Έτσι, ως δημοκρατικό έλλειμμα νοείται το χάσμα μεταξύ των εξουσιών που έχουν μεταβιβαστεί στο κοινοτικό επίπεδο και του ελέγχου αυτών των εξουσιών από τα εκλεγμένα κοινοβούλια (Williams, 1990). Εκφάνσεις αυτού του δημοκρατικού ελλείμματος αποτελούσαν η σύγχυση εξουσιών, η ανεπαρκής νομομοποίηση των θεσμών, η αδιαφάνεια, ο ανεπαρκής δημοκρατικός έλεγχος και η ανεπαρκής επιρροή των εθνικών κοινοβουλίων (Στεφάνου, 1996).

Από τις αρχές της δεκαετίας του 1990 ξεκινά μία νέα ενοποιητική διαδικασία, με την ίδρυση της ΕΕ, ως απόρροια της *Συνθήκης για την Ευρωπαϊκή Ένωση*, γνωστής ως *Συνθήκης του Maastricht* του 1992. Έκτοτε ξεκινά μία περίοδος κατά την οποία γίνεται εμφανέστερη η πορεία της ΕΕ προς μία μορφή διεθνούς πολιτικού συστήματος παρά ενός έστω ιδιότυπου διεθνούς τεχνοκρατικού και γραφειοκρατικού οργανισμού, ο οποίος τύγχανε μίας λανθάνουσας συναίνεσης των ευρωπαίων πολιτών. Ως συνέπεια αυτής της εξέλιξης είναι η έναρξη ενός νέου γύρου συζητήσεων και προβληματικής, σχετικά με την ύπαρξη ή όχι δημοκρατικού ελλείμματος στην ΕΕ.

Σε γενικές γραμμές επικρατεί η άποψη ότι το «δημοκρατικό έλλειμμα» σε σχέση με την ΕΕ, αναφέρεται σε μια αντιλαμβανόμενη περιορισμένη δυνατότητα του απλού πολίτη να επηρεάσει τη λειτουργία των θεσμικών οργάνων της ΕΕ, ως συνέπεια της περιορισμένης εκπροσώπησης του σ' αυτά τα θεσμικά όργανα και της έλλειψης λογοδοσίας τους προς τον ευρωπαϊκό πολίτη (Chryssochoou, 2007). Αναφέρεται δηλαδή «*στο κενό ανάμεσα στη δημοκρατική πρακτική, στη θεωρία και την πράξη*» (Zweifel, 2002). Τούτο σημαίνει ότι, ως δημοκρατικό έλλειμμα θεωρείται η αντίληψη των ευρωπαίων πολιτών ότι δεν γνωρίζουν πως λαμβάνονται οι κρίσιμες αποφάσεις που αφορούν τους ίδιους και τις χώρες τους, με συνέπεια να θεωρούν ότι υπάρχει έλλειμμα διαφάνειας και δημοκρατίας στην άσκηση πολιτικής εξουσίας στην ΕΕ.

Σύμφωνα με το γλωσσάριο της Eur-Lex: «*Το δημοκρατικό έλλειμμα είναι ένας όρος που χρησιμοποιείται από τα άτομα που ισχυρίζονται ότι τα θεσμικά όργανα της ΕΕ και οι διαδικασίες λήψης αποφάσεων τους στερούνται δημοκρατικής νομιμότητας και ότι φαίνονται απρόσιτα στον απλό πολίτη, εξαιτίας της περιπλοκότητάς τους. Το πραγματικό δημοκρατικό έλλειμμα της ΕΕ φαίνεται να αφορά την απουσία ευρωπαϊκής πολιτικής ζωής. Οι ψηφοφόροι της ΕΕ δεν θεωρούν ότι διαθέτουν αποτελεσματικό τρόπο να απορρίψουν μια «κυβέρνηση» που δεν τους ικανοποιεί και να αλλάξουν με κάποιον τρόπο την πορεία της πολιτικής ζωής και των πολιτικών*» (Eur-Lex).

Ωστόσο, «*το πρόβλημα νομιμοποίησης των πολιτικών της ΕΕ αποτελεί διαχρονικά ένα προσδιοριστικό χαρακτηριστικό του πλαισίου λειτουργίας της Ένωσης και αφορά το δημοκρατικό έλλειμμα*» (Βοσκόπουλος, 2009). Συνεπώς, η νομιμοποίηση του πολιτικού συστήματος της ΕΕ αποτελεί ουσιαστικά την επιβεβαίωση

της δημοκρατικής της λειτουργίας. Σύμφωνα με τις απόψεις των ερευνητών, η νομιμοποίηση θα μπορούσε να συνίσταται από την ύπαρξη συγκεκριμένων δημοκρατικών διαδικασιών λήψης και εκτέλεσης των αποφάσεων. Ακόμη, σύμφωνα με άλλες απόψεις, η νομιμοποίηση θα μπορούσε να συνίσταται στην ικανότητα του πολιτικού συστήματος να ενεργεί ρυθμιστικά και εκ του θετικού αποτελέσματος των ενεργειών του να συντηρεί την πεποίθηση ότι είναι το πλέον ενδεδειγμένο για το γενικό συμφέρον.

## 1.2. Νομιμοποίηση του πολιτικού συστήματος της ΕΕ εκ των διαδικασιών

Για μία νομιμοποίηση εκ των διαδικασιών (νομιμοποίηση εκ των εισροών), κάθε δημοκρατικά ιδρυόμενος οργανισμός θεσπίζει ένα καταστατικό στο οποίο ορίζονται οι στόχοι του, ο τρόπος ορισμού των ρυθμιστικών αρχών μέσω εκλεγμένων εκπροσώπων, η διαδικασία λήψης αιτιολογημένων αποφάσεων βασισμένων σε τυπικούς κανόνες ενίοτε με την απαίτηση δημόσιας συμμετοχής και έγκρισης και δικαστικά ελέγξιμες. Έτσι, μία επαρκής νομιμοποίηση του πολιτικού συστήματος της ΕΕ θα απαιτούσε: α) την ύπαρξη συγκεκριμένων κανόνων με βάση τους οποίους να ασκείται η πολιτική εξουσία, β) οι κανόνες αυτοί να απορρέουν από αποδεκτές πεποιθήσεις της κοινωνίας από την οποία πηγάζει η εξουσία, γ) η άσκηση της εξουσίας να γίνεται με τη ρητή συγκατάθεση της κοινωνίας ή των εκπροσώπων της (Beetham & Lord, 1998; βλ. και Schmidt, 2013).

Ωστόσο η ΕΕ χαρακτηρίζεται ως μη δημοκρατική λόγω της απουσίας ενός άμεσα δημοκρατικού συστήματος. Σύμφωνα με τους Andreas Føllesdal και Simon Hix, η επικρατούσα εκδοχή του δημοκρατικού ελλείμματος – και συνεπώς της έλλειψης επαρκούς νομιμοποίησης εκ των διαδικασιών – περιλαμβάνει τα ακόλουθα πέντε στοιχεία: α) Η ΕΕ διαθέτει αυξημένη εκτελεστική εξουσία έναντι ενός περιορισμένου εθνικού κοινοβουλευτικού ελέγχου. β) Η απώλεια του εθνικού κοινοβουλευτικού ελέγχου δεν έχει αντισταθμιστεί επαρκώς με ανάλογη αύξηση των εξουσιών του Ευρωπαϊκού Κοινοβουλίου. γ) Οι εκλογές στα κράτη-μέλη για την ανάδειξη μελών του Ευρωπαϊκού Κοινοβουλίου δεν αντιμετωπίζονται ως ευρωπαϊκές εκλογές, αλλά ως ενδιάμεσες εθνικές εκλογικές αναμετρήσεις. δ) Η ΕΕ βρίσκεται σε απόσταση από τους ευρωπαίους πολίτες-ψηφοφόρους, οι οποίοι δεν κατανοούν τη λειτουργία της και συνεπώς δεν τους είναι εύκολο να αξιολογήσουν το πολιτικό σύστημα της ΕΕ ως δημοκρατικό. ε) Συνέπεια των προαναφερθέντων είναι η μη υποστήριξη της εφαρμογής των πολιτικών που υιοθετούνται στην ΕΕ από μία πλειοψηφία πολιτών σε πολλά κράτη-μέλη, ενώ αξιοσημείωτη είναι η έλλειψη πολιτικής πάλης και ανταγωνισμού για τον έλεγχο της πολιτικής εξουσίας σε ευρωπαϊκό επίπεδο (Føllesdal & Hix, 2005; Hix, 2005, 2008).

Σύμφωνα με τον Hix, το έλλειμμα δημοκρατίας λόγω ανεπαρκούς νομιμοποίησης εκ των διαδικασιών μπορεί να αντιμετωπιστεί με την παροχή στους πολίτες των κρατών-μελών της δυνατότητας πολιτικοποίησης (politicization) στα πλαίσια της ευρωπαϊκής ενοποιητικής διαδικασίας, ώστε να γίνουν τυπικά και ουσιαστικά πολίτες της ΕΕ, συμμετέχοντας ενεργά στην ευρωπαϊκή πολιτική διαδικασία, με ουσιαστική εκπροσώπηση στους θεσμούς, ενεργό συμμετοχή στη λήψη των αποφάσεων και τελικά, υποστήριξη των εγκεκριμένων πολιτικών που υιοθετούνται από την ΕΕ (Hix, 2008α). Η υλοποίηση όμως αυτής της πολιτικοποίησης των

ευρωπαϊών πολιτών, προϋποθέτει τη δυνατότητα δημιουργίας και λειτουργίας ενός ευρωπαϊκού «Δήμου», όπως περιγράφεται στη συνέχεια (βλ. § 1.4).

### **1.3. Νομιμοποίηση πολιτικού συστήματος της ΕΕ εκ του αποτελέσματος**

Στη νομιμοποίηση εκ του αποτελέσματος, (νομιμοποίηση εκ των εκροών), τίθεται το ζήτημα της συνέπειας, της τεχνοκρατικής εμπειρίας, της αποτελεσματικότητας και της ικανότητας των ρυθμιστικών αρχών για την προώθηση του δημοσίου συμφέροντος (Majone, 1996). Ο Giandomenico Majone διακρίνει τις εφαρμοζόμενες πολιτικές σε ρυθμιστικές (regulatory) και μη ρυθμιστικές (non-regulatory). Οι μη ρυθμιστικές διακρίνονται σε αναδιανεμητικές και μη αναδιανεμητικές πολιτικές. Ο Majone αποδέχεται ότι η ΕΕ είναι ουσιαστικά ένα ρυθμιστικό κράτος και ότι οι εφαρμοζόμενες ρυθμιστικές πολιτικές της (κοινωνική, περιβαλλοντική, ανταγωνισμού, μεταφορών κ.λπ.) προορίζονται να διορθώσουν τις «αποτυχίες της αγοράς», όπως είναι η μονοπωλιακή συγκέντρωση, η ανεπάρκεια δημόσιων αγαθών κ.λπ.. Συνεπώς, εξ ορισμού οι εκροές ρυθμιστικής πολιτικής είναι αποδοτικές κατά Pareto, αφού παρέχεται ωφέλεια σε όρους κοινωνικής ευημερίας για όλους, εξυπηρετώντας το γενικό συμφέρον, με δεδομένο ότι πάντα υπάρχει κάποιο όφελος και κανείς δεν ζημιώνεται (βλ. Εικόνα 1) (Hix, 2008α; Μισσιρά, 2014). Απεναντίας στις αναδιανεμητικές πολιτικές υπάρχουν πάντοτε κερδισμένοι και ζημιωμένοι. Οι κυβερνήσεις των κρατών-μελών των ΕΚ και της ΕΕ μεταβίβασαν αρμοδιότητες κανονιστικής πολιτικής σε ευρωπαϊκό επίπεδο και έτσι, η δημιουργία της ενιαίας αγοράς, η εναρμόνιση των προτύπων προϊόντων, οι κανόνες υγείας και ασφάλειας ή ακόμη η νομισματική πολιτική, ως αποτελέσματα ρυθμιστικών αποδοτικών πολιτικών, υπήρξαν επωφελείς για το σύνολο των ευρωπαϊών πολιτών, αφού εδραίωναν την ευρωπαϊκή συνεργασία και αποτελούσαν κίνητρο για μια εποχή ευημερίας και οικονομικής ανάπτυξης, με δεδομένο μάλιστα ότι οι κυβερνήσεις των κρατών-μελών δεν θα μπορούσαν να τις εφαρμόσουν και υποχρεωτικά θα περιορίζονταν μόνο σε αναδιανεμητικές πολιτικές. Στην επίτευξη των στόχων αυτών συνεπώς συνέβαλε η αποπολιτικοποίηση (depoliticization) του ευρωπαϊκού ενοποιητικού εγχειρήματος και η περιθωριοποίηση της δημοκρατίας (Majone, 1998; Μισσιρά, 2014). Με αυτό το σκεπτικό, ο Majone υποστηρίζει ότι αν οι πολιτικές της ΕΕ ασκούσαν από τα «ανώτατα» θεσμικά όργανα (εκλεγμένο Ευρωπαϊκό Κοινοβούλιο, εκλεγμένη Επιτροπή κ.λπ.) με καθορισμένες δημοκρατικές διαδικασίες της, αυτές θα ήταν απλά αναδιανεμητικές και όχι αποδοτικές κατά Pareto, εφόσον η πολιτική πλειοψηφία της ΕΕ θα αποφάσιζε να έχει αποτελέσματα που θα ικανοποιούσαν τις άμεσες πολιτικές προτιμήσεις της, παρότι αυτές θα απόβαιναν σε βάρος των συμφερόντων του συνόλου, σε βάθος χρόνου, υπονομεύοντας με τον τρόπο αυτό, παρά αυξάνοντας τη νομιμότητα του συστήματος της ΕΕ (Majone, 1998; 2000a; 2000b).

Εικόνα 1. Η αποδοτική κατά Pareto πολιτική σε σύγκριση με αναδιανεμητικές πολιτικές

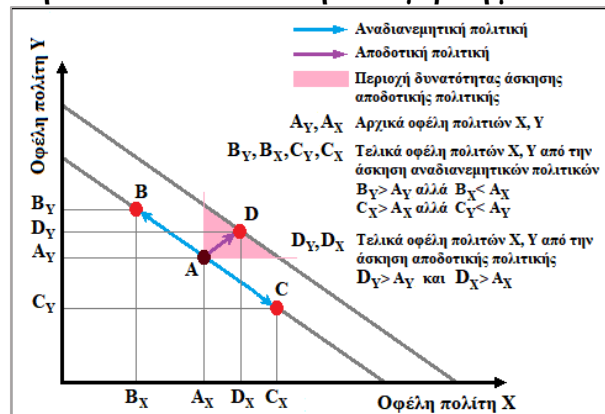

Πηγή: Hix (2008β), Μισσιρά (2014).

Επομένως, για τον Majone, το πρόβλημα για την ΕΕ δεν είναι ένα δημοκρατικό έλλειμμα αλλά ένα «έλλειμμα νομιμοποίησης» λόγω ελλιπούς χάραξης και εφαρμογής ρυθμιστικών αποδοτικών πολιτικών και η εκ των υστέρων κριτική τους, δηλαδή ένα ζήτημα «ελλείμματος δημοκρατικής λογοδοσίας» ή «κρίσης αξιοπιστίας». Αυτά που χρειάζεται η ΕΕ δεν είναι η δημοκρατικότερη λήψη και εκτέλεση των αποφάσεων, αλλά η διαφανέστερη διαδικασία λήψης αποφάσεων με γνώμονα μία σειρά από αποδοτικές πολιτικές, η εκ των υστέρων επανεξέτασή τους από τα δικαστήρια και τους διαμεσολαβητές, ο μεγαλύτερος επαγγελματισμός και η τεχνική εμπειρογνώμοσύνη για τη χάραξη και την υλοποίησή τους, η θέσπιση κανόνων προστασίας των δικαιωμάτων των μειοψηφιών και ο καλύτερος έλεγχος και η κριτική τους από τους ιδιωτικούς φορείς, τα μέσα ενημέρωσης και τους βουλευτές τόσο στην ΕΕ όσο και στα κράτη-μέλη. Ουσιαστικά απαιτείται η επιβολή ελέγχων και ισορροπιών (checks and balances), για να ελέγχονται τα διασυννοριακά αποτελέσματα των ασκούμενων πολιτικών και για να περιορίζεται η «τυραννία της πλειοψηφίας» προς όφελος του κοινού συμφέροντος. Το Ευρωπαϊκό Κοινοβούλιο θα πρέπει να επικεντρώνεται στην εξέταση των δαπανών της Επιτροπής και της ΕΕ και, ενδεχομένως, στη βελτίωση της ποιότητας της νομοθεσίας της ΕΕ. Δεν πρέπει να αναλώνεται σε αλλαγές ή καταψηφίσεις της ενωσιακής νομοθεσίας που αποδέχονται οι εκλεγμένες κυβερνήσεις των κρατών-μελών ή να προσπαθεί να επηρεάσει τις πολιτικές θέσεις της Επιτροπής (Majone, 2000b). Ωστόσο, ο ίδιος ο Majone αργότερα ομολογεί ότι «εάν η ΕΕ ήταν κράτος δεν θα μπορούσε να γίνει μέλος της ΕΕ» αφού η ΕΕ δεν είναι ένα πλήρως ανεπτυγμένο δημοκρατικό κράτος (Majone, 2002).

Κατά την άποψη του Andrew Moravcsik, θεωρητικού του φιλελεύθερου διακυβερνητισμού οι υφιστάμενοι έλεγχοι και ισορροπίες (checks and balances), ο έμμεσος δημοκρατικός έλεγχος μέσω των κυβερνήσεων των κρατών-μελών και οι αυξανόμενες αρμοδιότητες του Ευρωπαϊκού Κοινοβουλίου επαρκούν για να εξασφαλιστεί ότι η χάραξη πολιτικής της ΕΕ είναι σχεδόν καθόλα καθαρή, διαφανής, αποτελεσματική και ανταποκρίνεται πολιτικά στις απαιτήσεις των ευρωπαίων πολιτών (Moravcsik, 2002). Συνεπώς, «η ΕΕ είναι τόσο δημοκρατική όσο θα έπρεπε ή θα μπορούσε να είναι» (Moravcsik, 2008). Ο ίδιος αποδέχεται το ρυθμιστικό ρόλο των φορέων της ΕΕ, οι οποίοι χαράσσουν τις πολιτικές τους που αποκαθιστούν τη ομαλότητα για το σύνολο των πολιτών έναντι της απόλυτης επιβολής της βούλησης της πλειοψηφίας

Κριτική στις απόψεις των Majone και Moravcsik προβάλλουν πολλοί ερευνητές, ανάμεσα στους οποίους οι Andreas Føllesdal και Simon Hix. θεωρώντας ότι στις δημοκρατίες οι προτιμήσεις των πολιτών δημιουργούνται και μορφοποιούνται μέσα από πολιτικές συζητήσεις και αμφισβητήσεις, ενώ οι θεσμοί εξασφαλίζουν με αξιοπιστία ότι οι πολιτικές τους ανταποκρίνονται σε αυτές προτιμήσεις των πολιτών, αντί να διαπιστώνεται εκ των υστέρων ότι συμπίπτουν με αυτές. Συνεπώς, αποτελεί σημαντική δημοκρατική πρόκληση η δημιουργία θεσμών που παρέχουν τέτοιες ευκαιρίες και ανταπόκριση στις προτιμήσεις των πολιτών. Είναι πολύ πιο δύσκολο να υποθεθεί ότι οι πολιτικές της ΕΕ θα πρέπει να είναι κατά κανόνα αποδοτικές κατά Pareto (Føllesdal & Hix, 2005). Επιπλέον, ο έμμεσος έλεγχος μέσω των κυβερνήσεων των κρατών-μελών παρέχει σίγουρα κάποιο έλεγχο των πολιτικών αποτελεσμάτων της ΕΕ, κυρίως στους τομείς διακυβερνητικής συνεργασίας, όπως είναι η εξωτερική πολιτική, η αμυντική πολιτική, η αστυνομική συνεργασία κ.λπ., δεν υποκαθιστά τον προληπτικό έλεγχο του Ευρωπαϊκού Κοινοβουλίου, η αύξηση των εξουσιών του οποίου έχει βελτιώσει τη νομιμότητα των πολιτικών εκ των διαδικασιών (και κατά συνέπεια και εκ του αποτελέσματος), στους τομείς εκείνους στους οποίους ο έμμεσος έλεγχος των κυβερνήσεων των κρατών-μελών έχει αποδυναμωθεί λόγω της μετάβασης στην ψηφοφορία με ειδική πλειοψηφία.

#### **1.4. Η Κοινωνικο-ψυχολογική διάσταση και ο «Ευρωπαϊκός Δήμος»**

Το δημοκρατικό έλλειμμα, σύμφωνα με ορισμένους ερευνητές προσλαμβάνει δύο διαστάσεις: τη θεσμική ή/και την κοινωνικο-ψυχολογική διάσταση (Weiler, 1991). Η θεσμική διάσταση αναφέρεται στην αδυναμία των ευρωπαίων πολιτών των κρατών-μελών να επηρεάσουν τη διαδικασία παραγωγής πολιτικής εξαιτίας της πλημμελούς εκπροσώπησής τους στους θεσμούς των ΕΚ και αργότερα της ΕΕ. Η διάσταση αυτή σχετίζεται εν πολλοίς με το δημοκρατικό έλλειμμα λόγω ανεπαρκούς νομιμοποίησης εκ των διαδικασιών, που αναπτύχθηκε προηγουμένως (βλ. § 1.2).

Η κοινωνικο-ψυχολογική διάσταση αναφέρεται στην ύπαρξη ή όχι μιας κοινής ευρωπαϊκής ταυτότητας, και κατ' επέκταση ενός ευρωπαϊκού δήμου. Πρακτικά δηλαδή η συνιστώσα αυτή του δημοκρατικού ελλείμματος σχετίζεται με την κοινωνική αποδοχή και δημοκρατική νομιμοποίηση του συστήματος της ΕΕ και των θεσμών της από τους πολίτες των κρατών-μελών, στο βαθμό που οι ίδιοι θεωρούν τους εαυτούς τους ευρωπαίους πολίτες, που συνιστούν έναν ευρωπαϊκό δήμο, στον οποίο οι πολίτες έχουν μία διεθνή (ευρωπαϊκή) συνείδηση.

Ως δήμος θεωρείται «*μια ομάδα ανθρώπων, η πλειοψηφία των οποίων αισθάνεται επαρκώς συνδεδεμένη μεταξύ τους εθελοντικά, με τη δεσμευτική αποδοχή ενός δημοκρατικού λόγου και μίας σχετικής διαδικασίας λήψης αποφάσεων*» (Cederman 2001). Κατ' επέκταση, «*εάν δεν υπάρχει δήμος, δεν μπορεί να υπάρξει δημοκρατία*» (Weiler, 1999). Συνεπώς, χωρίς την ύπαρξη ενός δήμου, η μειοψηφία δεν είναι εύκολο να δεχτεί τη νομιμότητα της απόφασης της πλειοψηφίας (Dahl, 1998).

Οι απόψεις όμως περί ύπαρξης ή δυνατότητας ύπαρξης ενός ευρωπαϊκού δήμου διαφέρουν (Παπαδοπούλου, 2011). Μία άποψη θεωρεί μη υπαρκτό έναν ευρωπαϊκό δήμο, («no demos theory») με δεδομένο ότι λείπουν τα βασικά του στοιχεία, δηλαδή, η κοινή συλλογική ταυτότητα και νομιμοφροσύνη ως υποκειμενικά στοιχεία,

καθώς και οι κοινές πολιτισμικές και ιστορικές καταβολές ως αντικειμενικά στοιχεία εθνοπολιτισμικής ταύτισης, που αποτελούν ικανές προϋποθέσεις για τη δημιουργία των υποκειμενικών στοιχείων (Dellavalle, 1993). Η άποψη αυτή με βάση την εθνοπολιτισμική ταύτιση θεωρεί εφικτή την ύπαρξη ευρωπαϊκού δήμου, μόνο ως αποτέλεσμα ύπαρξης ενός ευρωπαϊκού έθνους, ταυτίζοντας έτσι το δήμο με το έθνος, το οποίο αποτελεί την υποκειμενική βάση νομιμοποίησης της ευρωπαϊκής δημοκρατίας. Την άποψη αυτή ενισχύουν και ισχυρισμοί ότι το έθνος είναι ο μόνος πιθανός φορέας της δημοκρατίας (Miller, 2000). Συνεπώς, με δεδομένο ότι δεν υπάρχει ευρωπαϊκός δήμος, τότε η νομιμοποίησή της ΕΕ απορρέει κατά κύριο λόγο από τα κράτη-μέλη και τους πολίτες τους, με αποτέλεσμα να μην απολαμβάνει πρωτογενή νομιμοποίηση.

Υπάρχει βέβαια και ο αντίλογος που προσπαθεί να καταρρίψει τη θεωρία περί μη δυνατότητας ύπαρξης ευρωπαϊκού δήμου με βάση την εθνοπολιτισμική ταύτιση. Αυτή στηρίζεται στον ισχυρισμό ότι στην πραγματικότητα υπάρχει σε μεγάλο βαθμό κοινή ευρωπαϊκή ιστορία, κοινές πολιτιστικές συνήθειες και κοινή θρησκεία, που συνιστούν προϋποθέσεις ύπαρξης κοινής ευρωπαϊκής ταυτότητας και νομιμοφροσύνης προς τους θεσμούς της ΕΕ, γεγονός που προσδίδει σε αυτούς δημοκρατική νομιμοποίηση (Mayer & Palmowski, 2004). Ηπιότερη εκδοχή της άποψης αυτής είναι η παραδοχή ότι παρά το γεγονός ότι ιστορικά συνήθως το έθνος υπήρξε η γενεσιουργός αιτία ίδρυσης κράτους, υπήρξαν περιπτώσεις όπου το κράτος κατασκεύασε το έθνος. Συνεπώς, η κατασκευή ενός έθνους (και κατ' επέκταση ενός ευρωπαϊκού έθνους) δεν είναι αδύνατη μελλοντικά, εφόσον βέβαια λειτουργήσουν οι κατάλληλες προϋποθέσεις (Hall, 2003), επιτρέποντας έτσι και την ύπαρξη και λειτουργία ενός ευρωπαϊκού δήμου.

Ωστόσο, είναι προφανές ότι και οι δύο προηγούμενες προσεγγίσεις θεωρούν ότι η ύπαρξη ενός ευρωπαϊκού δήμου απαιτεί οπωσδήποτε την προϋπαρξη εθνοπολιτισμικής ταύτισης και ομοιογένειας. Οι απόψεις αυτές έχουν δεχθεί κριτικές τόσο για την ταύτιση του δήμου με το έθνος (Τσάτσος, 2007; Weiler, 1995a, 1995b), όσο και για την ανάγκη ύπαρξης εθνοπολιτισμικής ομοιογένειας για τη λειτουργία της δημοκρατίας (Innerarity, 2014), με δεδομένο ότι υπάρχουν ιστορικά παραδείγματα που τις καταρρίπτουν.

Η θεωρία περί μη υπαρκτού δήμου («no demos theory») σε όλες τις εκδοχές της, αναφέρεται σε έναν υπερβολικά απαιτητικό ορισμό του «δήμου», ουτοπικό για τους φεντεραλιστές και στατικό (αγκυρωμένο) για τους διακυβερνητικούς. Αυτό που χρειάζεται η ΕΕ είναι η δημιουργία ενός ευρωπαϊκού δημόσιου χώρου – δήμου, που δεν θα χαρακτηρίζεται από την εθνοπολιτισμική του ομοιογένεια και τους περιορισμούς της, αλλά από ευρωπαίους πολίτες με κοινή ευρωπαϊκή ταυτότητα που απορρέει από κοινές αξίες και προσδοκίες, και κοινές αντιλήψεις δικαιωμάτων και υποχρεώσεων, που ξεπερνούν τις κρατικές-εθνικές διαφοροποιήσεις, καθώς και την ανάγκη κοινωνικής αλληλεγγύης και αλληλεξάρτησης, για την αντιμετώπιση κοινών προκλήσεων και κοινών κινδύνων (Innerarity, 2014).

Οι πολίτες αυτού του ευρωπαϊκού δήμου θα μπορούν να ανήκουν παράλληλα και σε άλλους μικρότερους δήμους, κρατικούς-εθνικούς και τοπικούς, φέροντας έτσι πολλαπλές ταυτότητες. Συνεπώς, ο διαχωρισμός του δήμου από το έθνος καθιστά θεωρητικά δυνατό το πρότυπο των πολλαπλών δήμων, οι οποίοι θα συνυπάρχουν. Η φύση της ΕΕ, ως πολυεθνικό πολιτικό σύστημα που στηρίζεται σε μία θεσμικά πολυεπίπεδη και

πολυκρατική συνύπαρξη, δεν αποκλείει τη διαμόρφωση ενός τέτοιου ευρωπαϊκού δήμου, ο οποίος θα συντίθεται από τους επιμέρους ευρωπαϊκούς λαούς, που θα ανήκουν σε επιμέρους κρατικούς-εθνικούς και τοπικούς δήμους. (Weiler, 1995a; 1995b; Χρυσόχου, 2007) και θα λειτουργεί ως μία πολυεθνική ευρωπαϊκή «δημοι-κρατία» (demoi-cracy) (Nicolaidis, 2004; Liebert, 2010), υλοποιώντας το σύνθημα της ΕΕ «ενότητα μέσα από τη διαφορετικότητα» (unity in diversity).

Στο σημείο αυτό είναι χρήσιμη η αναφορά στην έννοια του «εξευρωπαϊσμού» («europanization»), και της θετικής συμβολής του στη δημιουργία της προαναφερθείσας ευρωπαϊκής ενότητας, μέσω μίας αμφίδρομης διαδικασίας κατά την οποία οι θεσμοί, οι πολιτικές και οι κοινωνίες σε κρατικό-εθνικό επίπεδο διαμορφώνονται από την ενοποιητική διαδικασία και οδηγούνται σε σύζευξη με τα αντίστοιχα στοιχεία σε ενωσιακό (ευρωπαϊκό) επίπεδο (Schmidt & Radaelli, 2004). Σύμφωνα με έναν εύστοχο ορισμό, ως εξευρωπαϊσμός νοούνται οι «διεργασίες α) κατάρτισης, β) διάχυσης και γ) θεσμοθέτησης επίσημων και ανεπίσημων κανονισμών, διαδικασιών, παραδειγμάτων πολιτικής, στυλ, 'τρόπων να γίνονται τα πράγματα' και κοινών πεποιθήσεων και κανόνων, τα οποία καθορίζονται και ενοποιούνται για πρώτη φορά για τη χάραξη της δημόσιας πολιτικής και των εν γένει πολιτικών της ΕΕ και στη συνέχεια ενσωματώνονται στη λογική της εγχώριας (τοπικής) συζήτησης, των ταυτοτήτων, των πολιτικών δομών και των δημόσιων πολιτικών» (Radaelli, 2003).

## **2. Απόπειρες αποτίμησης της αίσθησης Δημοκρατικού Ελλείμματος**

Η αίσθηση ύπαρξης δημοκρατικού ελλείμματος εντός της ΕΕ αποτυπώνεται με χαρακτηριστικό τρόπο στο Ευρωβαρόμετρο, που αποτελεί έρευνα κοινής γνώμης η οποία διεξάγεται για λογαριασμό της Ευρωπαϊκής Επιτροπής. Από τις απαντήσεις των ευρωπαίων πολιτών, που παρουσιάζονται παρακάτω, προκύπτει ότι διαχρονικά, με ελάχιστες εξαιρέσεις, λιγότεροι από τους μισούς ευρωπαίους πολίτες πιστεύουν ότι ικανοποιούνται σε κάποιο βαθμό από το επίπεδο δημοκρατικής λειτουργίας της ΕΕ, καθώς και από την εικόνα που αποκομίζουν από αυτήν. Ακόμη, οι απόψεις των ευρωπαίων πολιτών για το κατά πόσο αισθάνονται ευρωπαίοι δεν είναι ιδιαίτερα ενθαρρυντικές, όπως προκύπτουν από τις απαντήσεις τους, γεγονός που πιθανώς να αναδεικνύει την απόσταση που τους χωρίζει από την αίσθηση ότι ανήκουν σε έναν ενιαίο ευρωπαϊκό δήμο.

Ωστόσο, ιδιαίτερα χαρακτηριστική είναι η έλλειψη ενδιαφέροντος των ευρωπαίων πολιτών για τη λειτουργία της ΕΕ, η οποία εκφράστηκε με το χαμηλό ποσοστό συμμετοχής στις ευρωεκλογές, που έφτασε σε ιστορικά χαμηλό επίπεδο το 2014, όταν ο μέσος όρος της ΕΕ ανήλθε μόλις στο 42,61%. Ορισμένοι αποδίδουν την αποστασιοποίηση του ευρωπαίου πολίτη στην έντονη αίσθηση δημοκρατικού ελλείμματος, που τον απομακρύνει από τα θεσμικά όργανα και τα κέντρα λήψης των αποφάσεων της ΕΕ.

Επιπλέον, ενώ σε κάθε νέο στάδιο αναβάθμισης της ευρωπαϊκής ενοποίησης, το ζήτημα της δημοκρατικής νομιμότητας τίθεται με μεγαλύτερη έμφαση, οι αντιδράσεις των ευρωπαίων πολιτών δεν ήταν πάντοτε οι αναμενόμενες. Έτσι, ενώ οι *Συνθήκες του Maastricht*, του *Άμστερνταμ*, της *Νίκαιας* και της *Λισσαβόνας* έκαναν σημαντικά βήματα προς την ενσωμάτωση της αρχής της δημοκρατικής νομιμότητας στο θεσμικό σύστημα της ΕΕ, ενισχύοντας τις αρμοδιότητες του Κοινοβουλίου και διευρύνοντας το πεδίο εφαρμογής της διαδικασίας



συναπόφασης, οι ευρωπαίοι πολίτες σε ορισμένα κράτη-μέλη απέρριψαν μέσω δημοψηφισμάτων την επικύρωση των συνθηκών, εκφράζοντας έτσι τη δυσαρέσκεία τους κυρίως – σύμφωνα με ορισμένους ερευνητές – λόγω της αίσθησης δημοκρατικού ελλείμματος. Μέσω δημοψηφισμάτων άλλωστε απορρίφθηκε και η *Συνταγματική Συνθήκη της ΕΕ*, προφανώς για τους ίδιους ακριβώς λόγους.

Τέλος ιδιαίτερη σημασία έχει το αποτέλεσμα του πρόσφατου βρετανικού δημοψηφίσματος για την παραμονή ή όχι της χώρας στην ΕΕ, καθώς και οι λόγοι για τους οποίους ψήφισαν αρνητικά κατά πλειοψηφία οι πολίτες της Βρετανίας, όπου διαφαίνεται η ύπαρξη αίσθησης δημοκρατικού ελλείμματος, η οποία συνέβαλε στη διαμόρφωση του τελικού αποτελέσματος του δημοψηφίσματος.

### 2.1. Οι απόψεις των πολιτών στην ΕΕ μέσα από το Ευρωβαρόμετρο

Παρά την έντονη κριτική που δέχεται κατά καιρούς, το Ευρωβαρόμετρο παρέχει μία συστηματική καταγραφή των τάσεων της κοινής γνώμης των Ευρωπαίων πολιτών σε τακτά χρονικά διαστήματα, τόσο ανά κράτος-μέλος, όσο και συνολικά, επιτρέποντας έτσι συγκρίσεις τόσο σε χρονική βάση όσο και σε γεωγραφική. Με δεδομένο ότι δεν υφίστανται άλλες δημοσκοπήσεις οι οποίες να παρέχουν στοιχεία για τις τάσεις της κοινής γνώμης σε ευρωπαϊκό επίπεδο με την προαναφερθείσα συχνότητα και γεωγραφική κατανομή, τα στοιχεία του Ευρωβαρόμετρου είναι δυνατόν να αξιοποιηθούν για τη χάραξη πολιτικών και την εξαγωγή συμπερασμάτων από την υλοποίησή τους.

Μια από τις ερωτήσεις που αφορά στη γνώμη των ευρωπαίων πολιτών για τη λειτουργία της δημοκρατίας στην ΕΕ, είναι ενδεικτική της αίσθησής τους για την ύπαρξη δημοκρατικού ελλείμματος. Από το 1993 έως το 2018, το ποσοστό των πολιτών που δηλώνουν ότι είναι ικανοποιημένοι σε κάποιο βαθμό από τη λειτουργία της δημοκρατίας στην ΕΕ μόλις ξεπερνά 50% (Νοέμβριος 2018), με δύο μόλις εξαιρέσεις κατά τις οποίες το ποσοστό αυτό και πάλι δεν φθάνει το 52% (Σεπτέμβριος 2007) ή το 54% (Οκτώβριος 2009) (βλ. Εικόνα 2). Τούτο σημαίνει ότι υπάρχει συνεχώς μία αίσθηση δημοκρατικού ελλείμματος στους ευρωπαίους πολίτες, οι οποίοι είτε δεν γνωρίζουν τον τρόπο λειτουργίας της ΕΕ και των θεσμών της και θεωρούν ότι βρίσκονται μακριά από τα κέντρα λήψης των αποφάσεων, οι οποίες λαμβάνονται χωρίς να ακούγεται η γνώμη τους, είτε γνωρίζουν πως λειτουργεί η ΕΕ και πιστεύουν ότι πράγματι η ΕΕ και οι θεσμοί της δεν λειτουργούν δημοκρατικά.

Ακόμη μία σημαντική ερώτηση που αφορά στην εικόνα που έχουν οι ευρωπαίοι πολίτες για την ίδια την ΕΕ, είναι ενδεικτική της ουδέτερης ή και αρνητικής εντύπωσης που έχει η πλειοψηφία γι' αυτήν. Έτσι, από το 2002 έως το 2018, η θετική εικόνα σε κάποιο βαθμό των ευρωπαίων πολιτών για την ΕΕ δεν ξεπερνά το 50%, με μόλις τρεις εξαιρέσεις, (Μάρτιος 2006, Σεπτέμβριος 2007, Οκτώβριος 2009), στις οποίες το ποσοστό μόνο σε μία περίπτωση (Οκτώβριος 2007) μόλις ξεπερνά το 53% (βλ. Εικόνα 3). Τα ποσοστά αυτά είναι ενδεικτικά της αδυναμίας της ΕΕ να πείσει τους ευρωπαίους πολίτες για τη χρησιμότητα και την αποτελεσματικότητά της, ενώ τα σχετικά μεγάλα ποσοστά που δηλώνουν ότι έχουν μία ουδέτερη εικόνα για την ΕΕ υποκρύπτουν πιθανόν άγνοια ή αδιαφορία για την ΕΕ και τη λειτουργία της, γεγονός όχι ενθαρρυντικό για την αναγκαιότητα ύπαρξης ενός «ευρωπαϊκού δήμου».

**Εικόνα 2. Απόψεις των ευρωπαίων πολιτών σχετικά με την ικανοποίησή τους για τη λειτουργία της δημοκρατίας στην ΕΕ.**

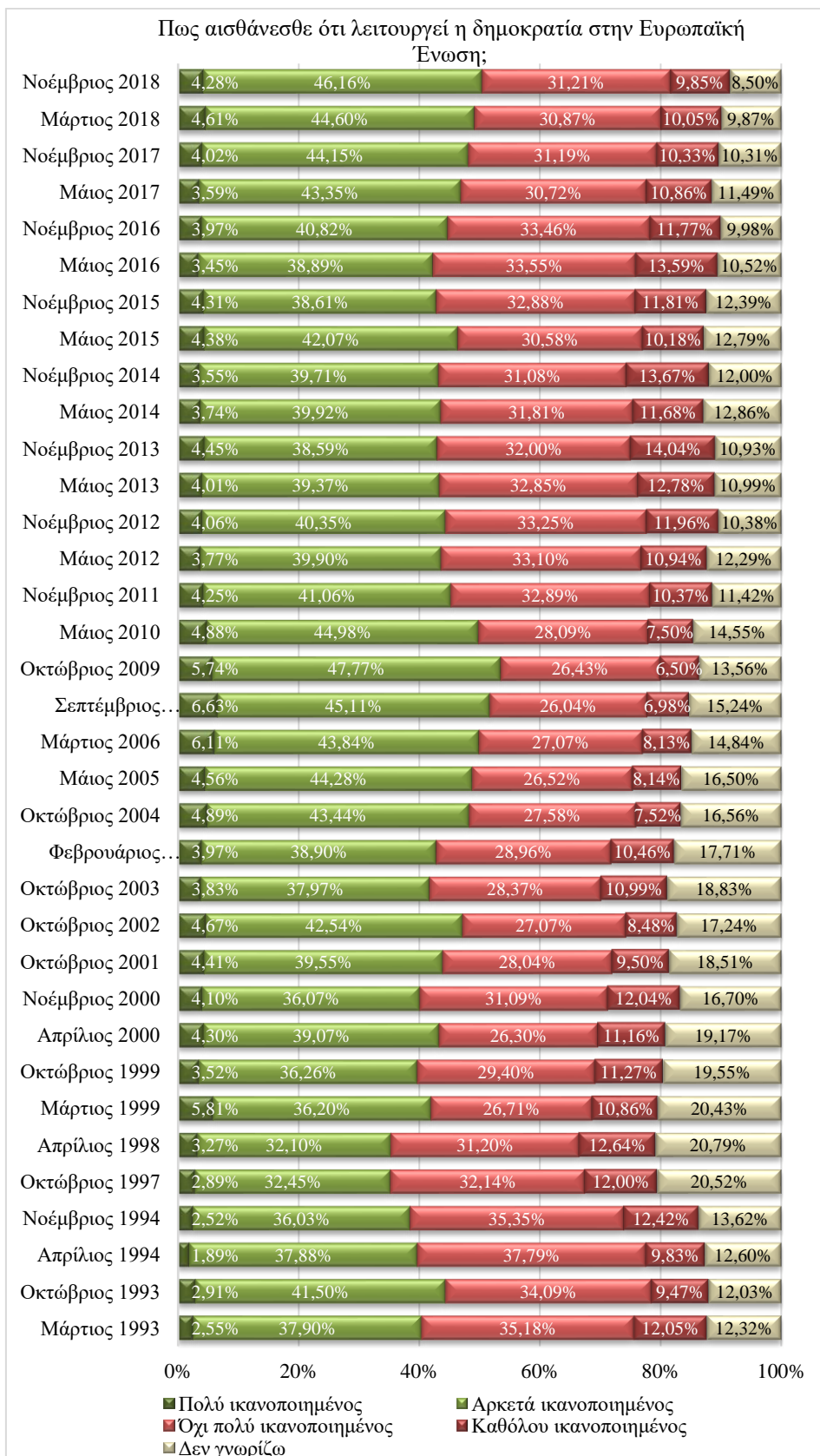

Πηγή: Ευροβαρόμετρο.

**Εικόνα 2. Απόψεις των ευρωπαίων πολιτών σχετικά με την εικόνα που έχουν σχηματίσει σε γενικές γραμμές για την ΕΕ.**

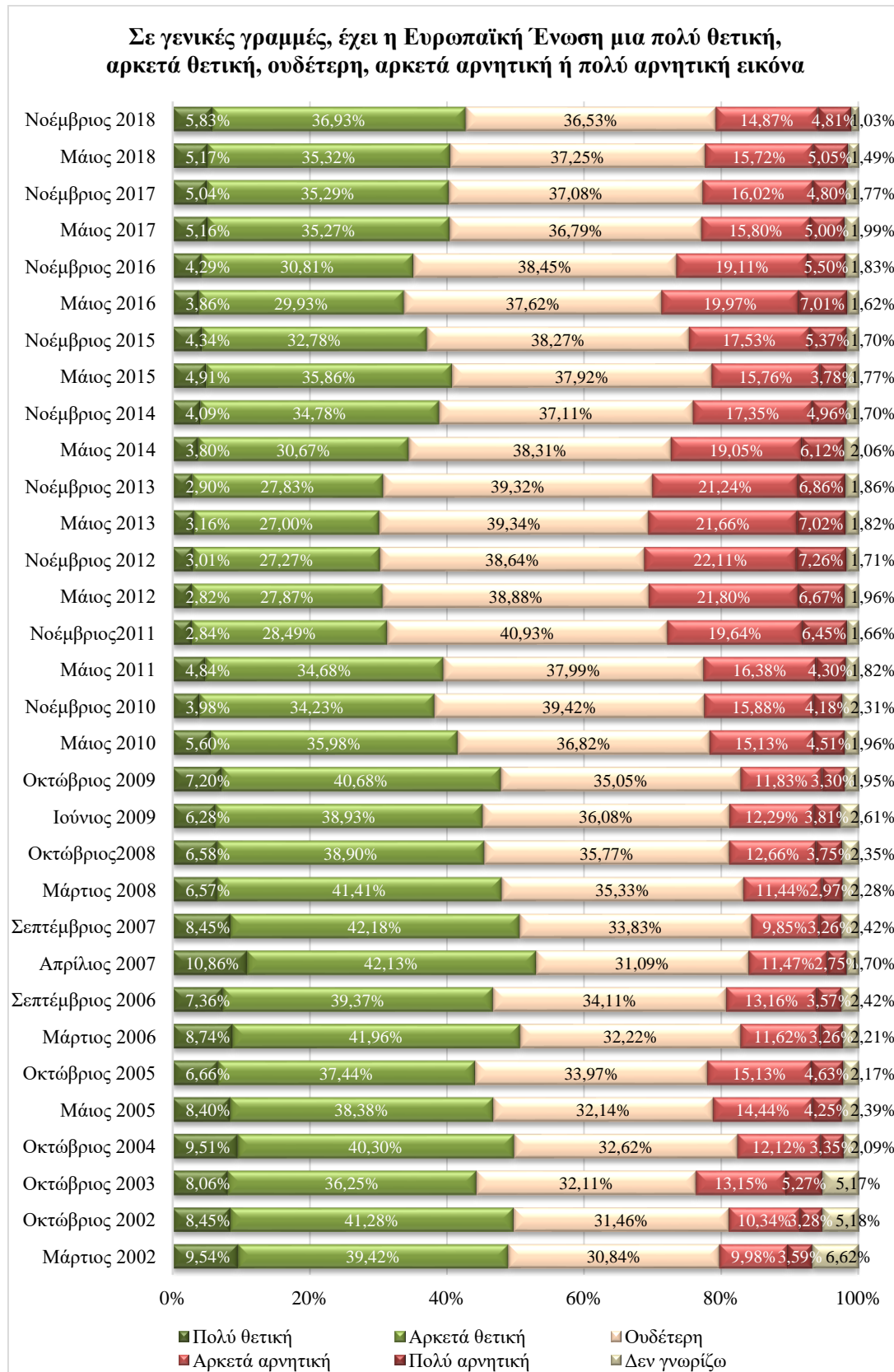

Πηγή: Ευροβαρόμετρο.

**Εικόνα 4. Απόψεις των ευρωπαίων πολιτών σχετικά με το εάν θεωρούν τον εαυτό τους παράλληλα και ευρωπαίο.**

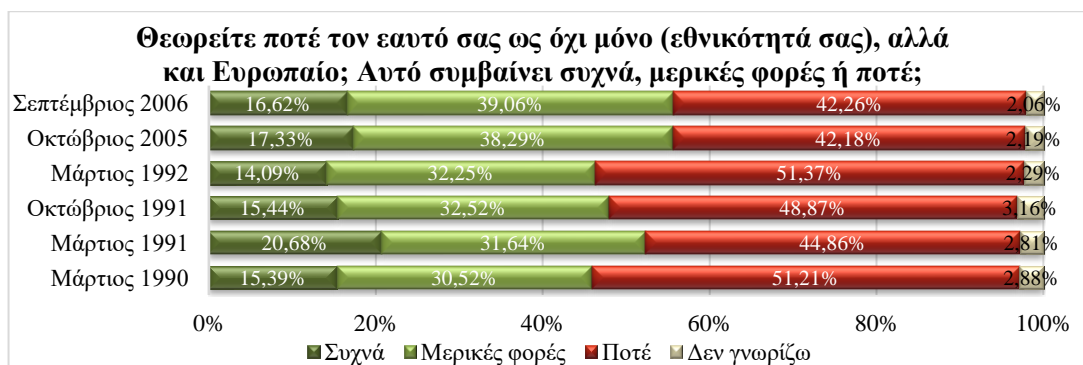

Πηγή: Ευροβαρόμετρο.

**Εικόνα 5. Απόψεις ευρωπαίων πολιτών σχετικά με το πως θεωρούν τον εαυτό τους μελλοντικά ως προς την εθνικότητα.**

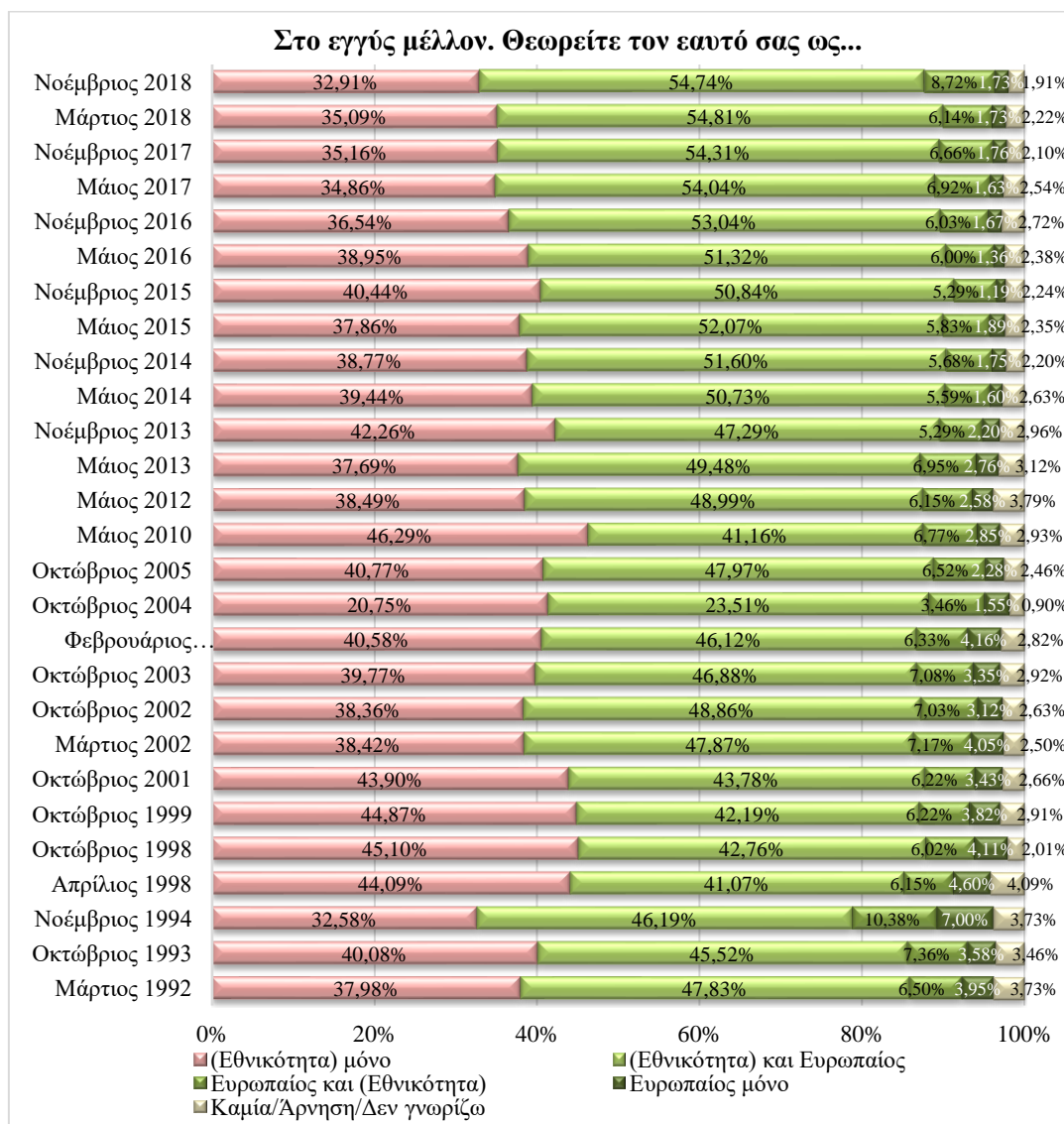

Πηγή: Ευροβαρόμετρο.

Περισσότερο ενδεικτικές της αίσθησης των ευρωπαίων πολιτών του «ανήκειν» σε μία ευρωπαϊκή ενότητα στην οποία να υπάρχουν ως πολίτες-δημότες, είναι οι απαντήσεις στην ερώτηση εάν εκτός από την εθνικότητά τους οι πολίτες αισθάνονται και Ευρωπαίοι. Στην ερώτηση αυτή οι απαντήσεις είναι διαχρονικά μοιρασμένες, με περίπου τους μισούς να θεωρούν έστω κάποιες φορές ότι είναι και Ευρωπαίοι (βλ. Εικόνα 4). Οι απαντήσεις αυτές είναι ενδεικτικές της απόστασης που πρέπει να καλυφθεί ώστε η πλειοψηφία των ευρωπαίων πολιτών να συνειδητοποιεί ότι ανήκει σε έναν «ευρωπαϊκό δήμο».

Σχετική είναι και η ερώτηση εάν οι πολίτες θα προσδιορίζουν τον εαυτό τους μελλοντικά ως Ευρωπαίο εκτός από την εθνικότητά τους (βλ. Εικόνα 5). Από τις απαντήσεις από το 1992 έως το 2018 προκύπτει ότι ένα ποσοστό μεταξύ περίπου 35% και 45% του συνόλου προσδιορίζει τον εαυτό του μόνο με την εθνικότητά του. Ωστόσο από τους υπόλοιπους που προσδιορίζουν τον εαυτό τους και ως ευρωπαίο, ένα ποσοστό μεταξύ περίπου 45% και 55% του συνόλου θεωρεί βασικό του προσδιορισμό την εθνικότητά του. Παρότι η πλειοψηφία θεωρεί ότι μελλοντικά θα μπορεί να προσδιορίζει τον εαυτό της ως Ευρωπαίο – είτε ως βασικό είτε ως δευτερεύοντα προσδιορισμό – ένα σημαντικό ποσοστό θα εξακολουθεί να αυτοπροσδιορίζεται μόνο με την εθνικότητά του, γεγονός που επιβεβαιώνει και για το μέλλον τη δυσκολία των ευρωπαίων πολιτών να συνειδητοποιήσουν ότι ανήκουν σε έναν «ευρωπαϊκό δήμο».

## 2.2. Ενδιαφέρον για συμμετοχή των ευρωπαίων πολιτών στις ευρωεκλογές

Η έλλειψη ενδιαφέροντος των Ευρωπαίων πολιτών για τη λειτουργία της ΕΕ εκφράστηκε και με το χαμηλό ποσοστό συμμετοχής στις ευρωεκλογές, από το 1979, που έφτασε σε ιστορικά χαμηλό επίπεδο το 2014, όταν ο μέσος όρος της ΕΕ ανήλθε μόλις στο 42,61% (βλ. Εικόνα 6). Γίνεται φανερό ότι το πρόβλημα αυτό έχει δύο συνιστώσες: α) μία αδιαφορία που απορρέει από άγνοια της λειτουργίας και της σημασίας της ΕΕ, ως συνέπεια ελλιπούς ενημέρωσης που έχει ο Ευρωπαίος πολίτης – γνωστό ως *έλλειμμα πληροφόρησης* – είτε από τη δική του αδιαφορία είτε από την αδιαφορία των αρμοδίων οργάνων της ΕΕ να τον ενημερώσουν σωστά και έγκαιρα, β) μία αποστροφή προς την ΕΕ και τους θεσμούς της, θεωρώντας ότι συμμετέχει σε μία εκλογική διαδικασία ψηφίζοντας άτομα τα οποία στην πράξη δεν τον εκπροσωπούν, αφού, κατά την άποψή του, οι αποφάσεις λαμβάνονται ερήμην του. Και οι δύο συνιστώσες συνηγορούν στην ύπαρξη αίσθησης δημοκρατικού ελλείμματος, αλλά και στη δυσκολία σύστασης ενός «ευρωπαϊκού δήμου», ο οποίος θα λειτουργούσε δημοκρατικά, παρέχοντας στους «ευρωπαίους δημότες» την βεβαιότητα ότι ανήκουν σε έναν ενιαίο δήμο ως ισότιμοι δημότες, με ελευθερία έκφρασης, κρίσης και ελέγχου των θεσμών του, που υποτίθεται ότι τον εκπροσωπούν και λειτουργούν προς το συμφέρον του. Ωστόσο, στις ευρωεκλογές του 2019, υπήρξε μία ενθαρρυντική συμμετοχή που έφθασε το 50,62%, το μεγαλύτερο ποσοστό της τελευταίας εικοσαετίας, σε μία χρονική περίοδο κατά την οποία καθεστώς με εμφανή εθνικιστικά και αντιευρωπαϊκά χαρακτηριστικά (Ουγγαρία, Πολωνία, Ιταλία) και ένα κράτος-μέλος σε καθεστώς αποχώρησης από την ΕΕ (Βρετανία).

Υπάρχουν βέβαια και οι περισσότερο ψύχραιμες απόψεις, σύμφωνα με τις οποίες, «η απομάκρυνση των πολιτών από την πολιτική δεν χαρακτηρίζει μόνο την ΕΚ/ΕΕ, αλλά σχεδόν όλες τις αντιπροσωπευτικές δημοκρατίες, όπου ένα μεγάλο μέρος – αν όχι η πλειοψηφία των πολιτών – απέχουν από τις εθνικές εκλογές»

(Μούσης, 2011). Εάν ανατρέξει κάποιος στα στατιστικά στοιχεία των εκλογικών αναμετρήσεων για την ανάδειξη εκπροσώπων σε περιφερειακά και κεντρικά κοινοβούλια των κρατών-μελών, θα διαπιστώσει την ύπαρξη σε σημαντικό βαθμό αυτής της αποχής, που αντανακλά την απομάκρυνση του πολίτη από τα πολιτικά δρώμενα και στο εσωτερικό των κρατών-μελών της ΕΕ.

**Εικόνα 6. Ποσοστά συμμετοχής των ψηφοφόρων των κρατών-μελών στις Ευρωεκλογές.**



Πηγή: Ευροβαρόμετρο.

### 2.3. Στοιχεία από τα δημοψηφίσματα για τις επικυρώσεις συνθηκών

Το ζήτημα της δημοκρατικής νομιμοποίησης που τέθηκε από τα τέλη της δεκαετίας του 1970, έγινε ιδιαίτερα επιτακτικό και αντιμετωπίστηκε αρχικά με την *ΕΕΠ*, με ισχύ από το 1986, η θεσμική διάσταση της οποίας επικεντρώθηκε στην ενίσχυση των εξουσιών του Ευρωπαϊκού Κοινοβουλίου, με δεδομένο ότι απαιτείτο πλέον η διαδικασία συναίνεσης για τη σύναψη συμφωνίας διεύρυνσης ή σύνδεσης, με νέα κράτη, ενώ θεσπίστηκε η διαδικασία συνεργασίας, που του παρείχε τη δυνατότητα, μέσω απόφασης του με πλειοψηφία, να μην αποδέχεται μία απόφαση του Συμβουλίου των Υπουργών, επιτρέποντας έτσι τη διπλή ανάγνωση της προτεινόμενης νομοθεσίας, ενώ θα μπορούσε να προβαίνει σε περιορισμένες τροποποιήσεις των προτάσεων της Επιτροπής. Καθίστατο έτσι το Ευρωπαϊκό Κοινοβούλιο, κατά κάποιο τρόπο, ισότιμος εταίρος του Συμβουλίου των Υπουργών στο νομοθετικό έργο. Ωστόσο, το πεδίο εφαρμογής της διαδικασίας αυτής παρέμενε περιορισμένο, ενώ, σε περίπτωση διαφωνίας, το Συμβούλιο των Υπουργών είχε τον τελευταίο λόγο. Η συνθήκη επικυρώθηκε με δημοψηφίσματα στη Δανία, και την Ιρλανδία. Στο Δανία, στις 27 Φεβρουαρίου του 1986, με ποσοστό συμμετοχής 75,4%, το 56,2% ψήφισε υπέρ της συνθήκης. Στην Ιρλανδία, στις 26 Μαΐου του 1987, με ποσοστό συμμετοχής 44,1%, το 69,9% ψήφισε επίσης υπέρ της συνθήκης.

Με τη *ΣΕΕ του Maastricht*, με ισχύ από το 1993, ο ρόλος του Ευρωπαϊκού Κοινοβουλίου αναβαθμίστηκε ακόμη περισσότερο για τον πρώτο πυλώνα της ΕΕ, με την επέκταση της ισχύουσας διαδικασίας συναίνεσης σε ορισμένους σημαντικούς τομείς, εκτός από την ένταξη των νέων κρατών-μελών ή τη σύνδεση των τρίτων

χωρών, που ίσχυε μέχρι τώρα. Η αναβάθμιση περιλάμβανε και την επέκταση της διαδικασίας συνεργασίας σε νέους τομείς, ενώ δημιουργείτο και η νέα διαδικασία συναπόφασης, η οποία επέτρεπε στο Ευρωπαϊκό Κοινοβούλιο να θεσπίζει πράξεις από κοινού με το Συμβούλιο των Υπουργών. Η διαδικασία αυτή συνεπάγονταν την ανάγκη ενίσχυσης μίας διαδικασίας διαβούλευσης μεταξύ του Ευρωπαϊκού Κοινοβουλίου και του Συμβουλίου των Υπουργών με σκοπό την κατάληξη σε συμφωνία. Η συμφωνία αυτή έπρεπε να εγκριθεί με ειδική πλειοψηφία από το Συμβούλιο των Υπουργών και με την απόλυτη πλειοψηφία από το Ευρωπαϊκό Κοινοβούλιο. Σε αντίθετη περίπτωση, η πρόταση δεν θα θεωρείτο εγκεκριμένη και το Ευρωπαϊκό Κοινοβούλιο θα είχε τον τελευταίο λόγο. Ωστόσο, το πεδίο εφαρμογής της διαδικασίας αυτής περιοριζόταν αυστηρά σε ορισμένα μέτρα που αφορούσαν στην ενιαία εσωτερική αγορά, η οποία ήδη καλυπτόταν από τη διαδικασία συνεργασίας, καθώς και σε μέτρα που αφορούσαν στην ελευθερία διακίνησης και εγκατάστασης, την υγεία, την έρευνα, το περιβάλλον, την εκπαίδευση και τον πολιτισμό. Το Ευρωπαϊκό Κοινοβούλιο επίσης θα συμμετείχε ενεργά στη διαδικασία διορισμού των μελών της Επιτροπής από τις κυβερνήσεις των κρατών-μελών, τα οποία θα εμφανίζονται ενώπιον του και θα υποβάλλουν το πρόγραμμά τους προς έγκριση. Παρόλα αυτά, ο ρόλος του Ευρωπαϊκού Κοινοβουλίου στο δεύτερο και τρίτο πυλώνα της ΕΕ θα ήταν συμβουλευτικός. Πριν από την υπογραφή της, η συνθήκη επικυρώθηκε με δημοψηφίσματα στην Ιρλανδία, τη Γαλλία και τη Δανία. Στο δημοψήφισμα της Ιρλανδίας, στις 18 Ιουνίου του 1992, με ποσοστό συμμετοχής 57,3%, η πλειοψηφία του 69,1% ψήφισε υπέρ της συνθήκης. Στο δημοψήφισμα της Γαλλίας, στις 20 Σεπτεμβρίου του 1992, με ποσοστό συμμετοχής 69,7%, οριακά το 51,0% ψήφισε υπέρ της συνθήκης. Ωστόσο, στο δημοψήφισμα της Δανίας, στις 2 Ιουνίου του 1992, με ποσοστό συμμετοχής 82,9%, η ΣΕΕ του Maastricht δεν έγινε αποδεκτή αφού υπέρ της συνθήκης ψήφισε το 49,3%. Μετά από αυτό η Δανία διαπραγματεύθηκε και πέτυχε τέσσερις ειδικές ρήτρες εξαίρεσης (opt outs) από το ενιαίο νόμισμα, την κοινή άμυνα, την ιθαγένεια και τις αρμοδιότητες της ΕΕ στους τομείς της δικαιοσύνης και της αστυνόμευσης. Έτσι, σε ένα νέο δημοψήφισμα που διεξήχθη στις 18 Μαΐου του 1993, ο λαός της Δανίας με μεγάλη συμμετοχή που έφθασε το 86,5%, αποδέχθηκε τη επικύρωση της ΣΕΕ με ποσοστό 56,7% των ψήφων.

Με τη *Συνθήκη του Άμστερνταμ*, με ισχύ από το 1999, παρότι δεν επιλύονταν βασικά θεσμικά ζητήματα της ΕΕ, απλοποιούνταν και επεκτείνονταν οι διαδικασίες συναπόφασης που αντικαθιστούσαν στις διαδικασίες συνεργασίας και ενίσχυαν το ρόλο του Ευρωπαϊκού Κοινοβουλίου. Το Ευρωπαϊκό Κοινοβούλιο θα έπρεπε πλέον να εγκρίνει, και όχι απλά να γνωμοδοτεί, για το διορισμό του Προέδρου της Επιτροπής από τις κυβερνήσεις των κρατών-μελών, οι οποίες με τη σειρά τους όφειλαν να διαβουλεύονται με το Ευρωπαϊκό Κοινοβούλιο πριν από το διορισμό νέων Επιτρόπων. Πριν από την υπογραφή της, η συνθήκη επικυρώθηκε με δημοψηφίσματα στην Ιρλανδία και τη Δανία. Στο δημοψήφισμα της Ιρλανδίας, στις 22 Μαΐου του 1998, με ποσοστό συμμετοχής 56,2%, η πλειοψηφία του 61,7% ψήφισε υπέρ της συνθήκης. Στο δημοψήφισμα της Δανίας, στις 28 Μαΐου του 1998, με ποσοστό συμμετοχής 76,2%, το 55,1% ψήφισε υπέρ της συνθήκης. Η *Συνθήκη του Άμστερνταμ* υπήρξε η μοναδική συνθήκη που δεν απορρίφθηκε από κάποιο δημοψήφισμα κράτους-μέλους της ΕΕ..

Με τη *Συνθήκη της Νίκαιας*, με ισχύ από το 2003, οι θεσμικές μεταρρυθμίσεις που πραγματοποιήθηκαν, χαρακτηρίστηκαν ως «τεχνικές» και «περιορισμένες». Ο ρόλος του Ευρωπαϊκού Κοινοβουλίου ενισχύθηκε σε κάποιο βαθμό, αφού η διαδικασία συναπόφασης επεκτάθηκε για να καλύψει νέα ζητήματα που έπρεπε να εγκριθούν από το Συμβούλιο των Υπουργών με ειδική πλειοψηφία και αφορούσαν σε μια σειρά από σημαντικούς τομείς όπως η βιομηχανία, η μετανάστευση, η δικαστική συνεργασία σε αστικές υποθέσεις κ.ά.. Η Ιρλανδία υπήρξε η μόνη χώρα που εισήγαγε τη συνθήκη σε δημοψήφισμα όντας συνταγματικά υποχρεωμένη να το κάνει. Έτσι, στο δημοψήφισμα που διεξήχθη στις 8 Ιουνίου του 2001, με ποσοστό συμμετοχής μόλις 34,8%, η *Συνθήκη της Νίκαιας* δεν έγινε αποδεκτή αφού υπέρ της συνθήκης ψήφισε το 46,1%. Η ΕΕ για να ξεπεραστούν τα προβλήματα επικύρωσης της συνθήκης, παρείχε εγγυήσεις ότι η Ιρλανδία δεν θα υποχρεωθεί να συμμετέχει στην Κοινή Αμυντική Πολιτική, χωρίς ωστόσο να υπάρξουν στη συνθήκη σχετικές ρήτρες εξαίρεσης (opt outs). Έτσι, το νέο δημοψήφισμα που διεξήχθη στην Ιρλανδία στις 19 Οκτωβρίου του 2002, με ποσοστό συμμετοχής 49,5%, η πλειοψηφία του 62,9% ψήφισε υπέρ της συνθήκης.

Ωστόσο, η προσπάθεια θέσπισης μίας *Συνταγματικής Συνθήκης για την ΕΕ*, έφερε στο προσκήνιο σημαντικά προβλήματα σχετικά με τις απόψεις των ευρωπαίων πολιτών για τον τρόπο λειτουργίας της ΕΕ και της ύπαρξης αίσθησης δημοκρατικού ελλείμματος. Η ΣΣΕ προέβλεπε δημοκρατικότερες διαδικασίες και λειτουργίες, που θα ήταν περισσότερο ελεγχόμενες και προσβάσιμες από τους πολίτες των κρατών-μελών. Σε γενικές γραμμές προέβλεπε μεταξύ άλλων: α) την ενίσχυση των δικαιωμάτων των πολιτών, με την ενσωμάτωση του Χάρτη Θεμελιωδών Δικαιωμάτων της Ευρωπαϊκής Ένωσης, ο οποίος αποκτούσε έτσι νομική ισχύ, β) την ενίσχυση των εξουσιών του Ευρωπαϊκού Κοινοβουλίου, που καθίσταται από κοινού με το Συμβούλιο Υπουργών το κύριο νομοθετικό όργανο της Ε.Ε., και αποφασίζει, επίσης, για τον προϋπολογισμό, γ) την αναβάθμιση του ρόλου των εθνικών κοινοβουλίων με την έγκαιρη ενημέρωσή τους για τις προτεινόμενες νομοθεσίες της Επιτροπής και τις πολιτικές της ΕΕ και την εισαγωγή μηχανισμού έγκαιρης προειδοποίησης, με βάση τον οποίο τα εθνικά κοινοβούλια θα εμπλέκονται στον έλεγχο συμβατότητας των προτεινόμενων νομοθεσιών με την αρχή της επικουρικότητας, δ) την εκλογή του Προέδρου της Επιτροπής από το Ευρωπαϊκό Κοινοβούλιο ύστερα από πρόταση του Ευρωπαϊκού Συμβουλίου, ε) την αναγνώριση της σημασίας της διαβούλευσης με τους κοινωνικούς εταίρους και του δικαιώματος των Ευρωπαίων πολιτών για προσφυγή στον Ευρωπαίο Διαμεσολαβητή. Η ΣΣΕ εγκρίθηκε με δημοψήφισμα που διεξήχθη στην Ισπανία στις 20 Φεβρουαρίου του 2005 με ποσοστό 81,8% και συμμετοχή 41,8%. Με ανάλογο δημοψήφισμα στο Λουξεμβούργο, στις 10 Ιουλίου του 2005, εγκρίθηκε η ΣΣΕ με ποσοστό 56,5% και συμμετοχή 90,4%. Όμως, στις 29 Μαΐου του ίδιου έτους η ΣΣΕ απορρίφθηκε με δημοψήφισμα στη Γαλλία με ποσοστό 54,7%, και συμμετοχή 69,4%, ενώ το ίδιο συνέβη αμέσως μετά και στην Ολλανδία, την 1<sup>η</sup> Ιουνίου του ίδιου έτους, με ποσοστό 61,5% και συμμετοχή 63,3%. Μετά από αυτά τα αποτελέσματα, ακυρώθηκαν τα υπόλοιπα προγραμματισμένα δημοψήφισμα σε κράτη-μέλη, ενώ οι προσπάθειες καθιέρωσης ενός Ευρωπαϊκού Συντάγματος εγκαταλείφθηκαν. Ορισμένοι αναλυτές ερμηνεύσουν τα αποτελέσματα των δημοψηφισμάτων στη Γαλλία και την Ολλανδία, δύο ιδρυτικών κρατών των ΕΚ και πρωταγωνιστών της ευρωπαϊκής ενοποίησης, ως αποτέλεσμα ελλιπούς ενημέρωσης για το αντικείμενο των δημοψηφισμάτων και κακής



οργάνωσής τους, αλλά και δυσaráεσκείας προς τις εθνικές κυβερνήσεις, που εκφράστηκε με αυτόν τον τρόπο. Άλλοι το αποδίδουν στην έντονη αίσθηση δημοκρατικού ελλείμματος των ευρωπαϊών πολιτών.

Η *Μεταρρυθμιστική Συνθήκη της Λισσαβόνας*, ως υποκατάστατο της ΣΣΕ, με ισχύ από το 2009, προέβλεπε νέες σημαντικές εξουσίες για το Ευρωπαϊκό Κοινοβούλιο, όσον αφορά στη νομοθεσία, στον προϋπολογισμό της ΕΕ, αλλά και στις διεθνείς συμφωνίες, με δεδομένη την αυξημένη χρήση της διαδικασίας συναπόφασης που μετονομάζεται σε *συνήθη νομοθετική διαδικασία*. Η διαδικασία αυτή διευρύνεται σε περισσότερους από σαράντα νέους τομείς, όπως η γεωργία, η δικαιοσύνη, η ενέργεια, τα διαρθρωτικά ταμεία, η μετανάστευση κ.ά.. με συνέπεια, το Ευρωπαϊκό Κοινοβούλιο να διασφαλίζει ισότιμη θέση με το Συμβούλιο των Υπουργών, το οποίο υποχρεούται πλέον να συνεδριάζει δημόσια. Ακόμη, ενισχύεται και ο ελεγκτικός ρόλος των εθνικών κοινοβουλίων, παράλληλα και όχι σε βάρος της διεύρυνσης των αρμοδιοτήτων του Ευρωπαϊκού Κοινοβουλίου. Τα εθνικά κοινοβούλια, εκτός των άλλων θα ελέγχουν και την τήρηση της αρχής της επικουρικότητας. Έτσι, κάθε εθνικό κοινοβούλιο θα μπορεί στο εξής να προβάλλει λόγους για τους οποίους θεωρεί ότι μια πρόταση δεν είναι σύμφωνη με αυτή την αρχή, οπότε ξεκινά μια διαδικασία σε δύο φάσεις: α) εάν το ένα τρίτο των εθνικών κοινοβουλίων θεωρεί ότι μια πρόταση δεν είναι σύμφωνη με την αρχή της επικουρικότητας, η Επιτροπή θα πρέπει να επανεξετάσει την πρότασή της και να αποφασίσει αν θα τη διατηρήσει, θα την τροποποιήσει ή θα την αποσύρει και β) εάν η πλειοψηφία των εθνικών κοινοβουλίων συμμαρτίζεται τις ίδιες ανησυχίες ενώ η Επιτροπή αποφασίσει να διατηρήσει την πρότασή της, τότε η Επιτροπή θα πρέπει να διατυπώσει τα επιχειρήματά της, ενώ το Ευρωπαϊκό Κοινοβούλιο και το Συμβούλιο των Υπουργών θα αποφασίσουν κατά πόσον πρέπει να συνεχιστεί η σχετική νομοθετική διαδικασία. Ταυτόχρονα, οι πολίτες αποκτούν αυξημένο ρόλο με τη θεσμοθέτηση του μηχανισμού της «πρωτοβουλίας πολιτών», αφού η συνθήκη τους παρέχει το δικαίωμα να υποβάλουν κάθε πρόταση που έχει την υποστήριξη ενός εκατομμυρίου πολιτών της ΕΕ και υποχρεώνει την Επιτροπή να την εξετάσει. Η συνθήκη ενσωμάτωσε το *Χάρτη Θεμελιωδών Δικαιωμάτων της Ευρωπαϊκής Ένωσης* στο ευρωπαϊκό πρωτογενές δίκαιο, ενώ ενίσχυσε τις τέσσερις ελευθερίες της ενιαίας εσωτερικής αγοράς καθώς και την πολιτική, οικονομική και κοινωνική ελευθερία των Ευρωπαϊών πολιτών. Η Ιρλανδία υπήρξε και πάλι η μόνη χώρα που εισήγαγε τη συνθήκη σε δημοψήφισμα όντας συνταγματικά υποχρεωμένη να το κάνει. Έτσι, στο δημοψήφισμα που διεξήχθη στις 12 Ιουνίου του 2008, με ποσοστό συμμετοχής 53,1%, η *Συνθήκη της Λισσαβόνας* δεν έγινε αποδεκτή αφού υπέρ της συνθήκης ψήφισε το 46,6%. Η ιρλανδική κυβέρνηση αποφάσισε τη διεξαγωγή ενός δεύτερου δημοψηφίσματος στις 2 Οκτωβρίου του 2009, αφού έλαβε εγγυήσεις – τις γνωστές ως ιρλανδικές εγγυήσεις – από το Ευρωπαϊκό Συμβούλιο, για θέματα όπως τη διατήρηση ενός επιτρόπου από κάθε κράτος-μέλος στην Επιτροπή, τη φορολογία, τις εκτρώσεις και την εθνική άμυνα, τα οποία φαίνεται ότι οδήγησαν στο αρνητικό αποτέλεσμα. Με το δεύτερο δημοψήφισμα η συνθήκη επικυρώθηκε με την αποδοχή του 67,1% των ψηφισάντων και συμμετοχή 59,0%.

Ιδιαίτερα ενδιαφέροντα είναι τα αποτελέσματα δημοσκόπησης που έγινε με πρωτοβουλία της Επιτροπής, από τις 15 έως τις 18 Ιουνίου του 2008 για τη διερεύνηση των λόγων απόρριψης της *Συνθήκης της Λισσαβόνας* με το δημοψήφισμα που διεξήχθη στις 12 Ιουνίου του 2008 στην Ιρλανδία (European Commission, 2008). Οι

πολίτες της Ιρλανδίας δήλωσαν ότι απέρριψαν τη συνθήκη γιατί δεν είχαν επαρκή ενημέρωση για τη συνθήκη σε ποσοστό 22%, για την προστασία της ιρλανδικής ταυτότητας σε ποσοστό 12%, γιατί είναι ενάντια στην ευρωπαϊκή ενοποίηση σε ποσοστό 5%, για να αποφευχθεί η εκπροσώπησή τους διεθνώς μέσω της ΕΕ σε ποσοστό 4%, επειδή τα μεγάλα κράτη αποφασίζουν για λογαριασμό τους σε ποσοστό 4% και γιατί έτσι προστατεύονται τα μικρότερα κράτη σε ποσοστό 3% (βλ. Εικόνα 7). Ωστόσο, ένα ποσοστό 6% δήλωσε ότι καταψήφισε τη συνθήκη γιατί δεν έχει εμπιστοσύνη στους πολιτικούς, ενώ ένα ποσοστό 4% θεωρεί την ψήφο του ως διαμαρτυρία ενάντια στις κυβερνητικές πολιτικές.

Αξιοσημείωτη είναι και η αναφορά σε δύο ακόμη δημοψηφίσματα που έχουν διεξαχθεί στη Δανία και τη Σουηδία, για την ένταξη στην Ευρωζώνη. Και τα δύο δημοψηφίσματα είχαν αρνητική έκβαση. Συγκεκριμένα, στο δημοψήφισμα που διεξήχθη στη Δανία, στις 28 Σεπτεμβρίου του 2000, το 53,2% των ψηφοφόρων ψήφισε κατά της ένταξης, με προσέλευση 87,6%. Επίσης, στο δημοψήφισμα που διεξήχθη στη Σουηδία, στις 14 Σεπτεμβρίου του 2003, το 55,9% των ψηφοφόρων ψήφισε κατά της ένταξης, με προσέλευση 82,6%.

**Εικόνα 7. Λόγοι καταψήφησης της Συνθήκης της Λισσαβόνας, στο δημοψήφισμα της Ιρλανδίας στις 12 Ιουνίου 2008.**

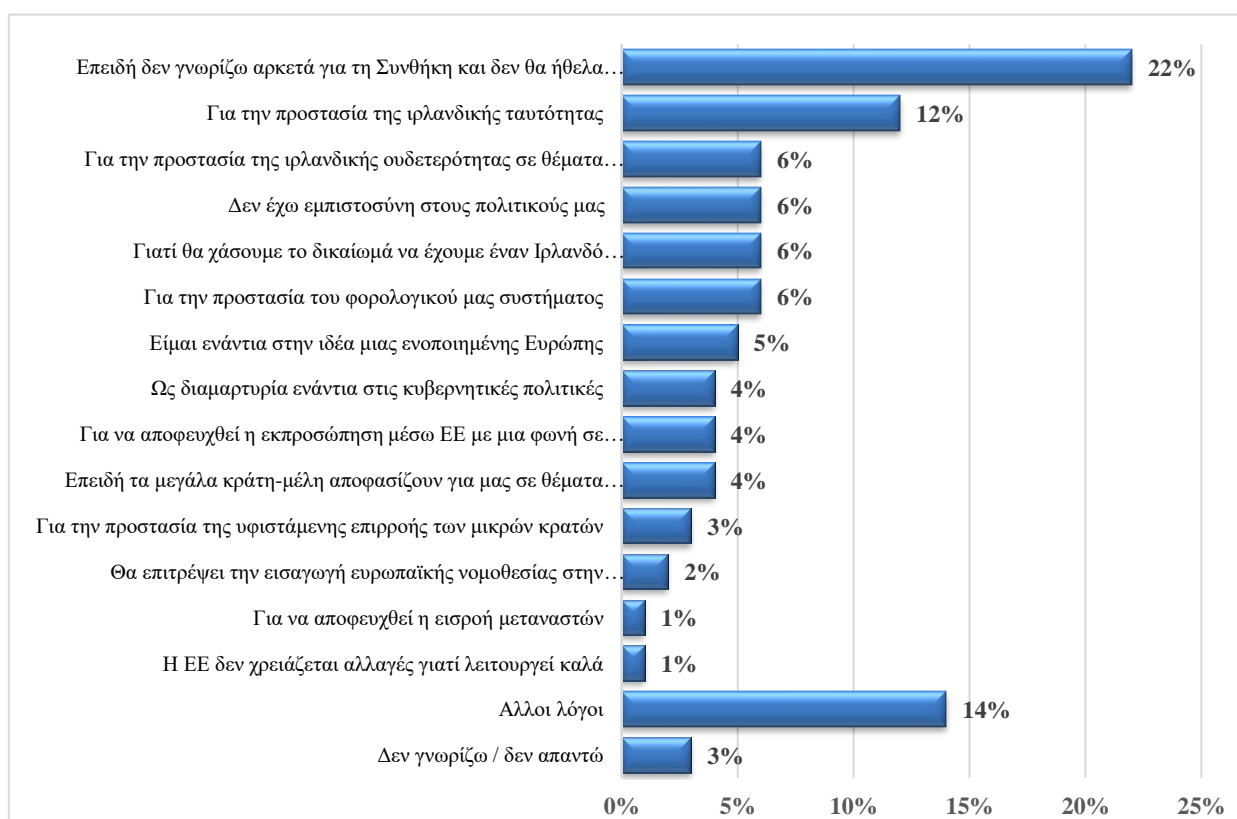

Πηγή European Commission – Flash Eurobarometer (2008).

Είναι συνεπώς φανερό ότι παρά τις συνεχείς προβλέψεις των προς έγκριση συνθηκών για δημοκρατικότερες διαδικασίες και λειτουργίες της ΕΕ, οι πολίτες των κρατών-μελών όπου διεξάγονταν δημοψηφίσματα για την έγκρισή τους, θεωρώντας, άλλοτε ότι δεν έχουν επαρκή ενημέρωση, άλλοτε ότι αποφασίζουν κάποιοι γραφειοκράτες και οι κυβερνήσεις των ισχυρότερων κρατών-μελών για τους ίδιους, άλλοτε για λόγους

διαμαρτυρίας προς την πολιτική της κυβέρνησης του δικού τους κράτους και άλλοτε για λόγους καθαρά εθνικούς και ωφελμιστικούς, συνήθως τις απέρριπταν. Και ενώ είναι προφανές ότι η έγκρισή τους θα οδηγούσε σε δημοκρατικότερες διαδικασίες στην ΕΕ, οι προαναφερθέντες λόγοι, με κυρίαρχο αυτόν του ελλείμματος πληροφόρησης, υπήρξαν οι καταλύτες της απόρριψής τους, εντείνοντας έτσι την αίσθηση ύπαρξης δημοκρατικού ελλείμματος στην ΕΕ.

Ωστόσο, είναι αξιοσημείωτη η απόφαση του Ομοσπονδιακού Συνταγματικού Δικαστηρίου της Γερμανίας, της 12<sup>ης</sup> Οκτωβρίου του 1993, σχετικά με τη *Συνθήκη για την Ευρωπαϊκή Ένωση*, που τόνιζε ότι, δεδομένου του σταδίου στο οποίο βρισκόταν τη στιγμή εκείνη η ευρωπαϊκή ενοποίηση, η δημοκρατική νομιμοποίηση προκύπτει από τις αρμοδιότητες των εθνικών κοινοβουλίων σχετικά με τις δραστηριότητες των ευρωπαϊκών θεσμικών οργάνων. Σύμφωνα πάντα με την απόφαση αυτή, δημοκρατική νομιμοποίηση προσφέρει και το Ευρωπαϊκό Κοινοβούλιο, τα μέλη του οποίου εκλέγονται από τους πολίτες των κρατών-μελών.

#### 2.4. Στοιχεία από το βρετανικό δημοψήφισμα παραμονής ή όχι στην ΕΕ

Ιδιαίτερη σημασία έχει η αναφορά στο δημοψήφισμα της Βρετανίας για την παραμονή ή όχι της χώρας στην ΕΕ, της 23<sup>ης</sup> Ιουνίου του 2016, κατά το οποίο υπέρ της αποχώρησης ψήφισε το 51.9% των ψηφοφόρων, με προσέλευση 72,2%. Για όσους ψήφισαν κατά της παραμονής της χώρας στην ΕΕ, ορισμένες απαντήσεις τους για τους λόγους που τους οδήγησαν σ' αυτήν την απόφαση είναι δυνατόν να συσχετιστούν με την ύπαρξη αίσθησης δημοκρατικού ελλείμματος στην ΕΕ (Lord Ashcroft, 2016).

Από τους ψηφοφόρους που ψήφισαν *υπέρ της αποχώρησης* (βλ. Εικόνα 8), σχεδόν οι μισοί (49%) δήλωσαν ότι ο μεγαλύτερος και μοναδικός λόγος που επιθυμούν να εγκαταλείψουν την ΕΕ ήταν ότι *«οι αποφάσεις για το Ηνωμένο Βασίλειο πρέπει να λαμβάνονται στο Ηνωμένο Βασίλειο»*. Το ένα τρίτο (33%) δήλωσε ότι ο κύριος λόγος ήταν ότι η αποχώρηση θα *«πρόσφερε την καλύτερη ευκαιρία στο Ηνωμένο Βασίλειο να ανακτήσει τον έλεγχο της μετανάστευσης και των δικών του συνόρων»*. Λίγο πάνω από ένας στους οκτώ (13%) δήλωσε ότι η παραμονή θα σήμαινε ότι δεν θα υπήρχε δυνατότητα αντίδρασης *«στον τρόπο με τον οποίο η ΕΕ επεκτείνει την ιδιότητα μέλους ή τις εξουσίες της τα επόμενα χρόνια»*. Σχεδόν ο ένας στους είκοσι (6%) δήλωσε ότι ο κύριος λόγος αποχώρησης είναι ότι *«ειδικά για το εμπόριο και την οικονομία, το Ηνωμένο Βασίλειο θα επωφεληθεί περισσότερο εφόσον βρίσκεται εκτός των συνόρων ΕΕ από το να αποτελεί μέρος της»*.

**Εικόνα 8. Λόγοι ψήφισης κατά της παραμονής στην ΕΕ στο δημοψήφισμα της Βρετανίας, στις 23 Ιουνίου 2016.**

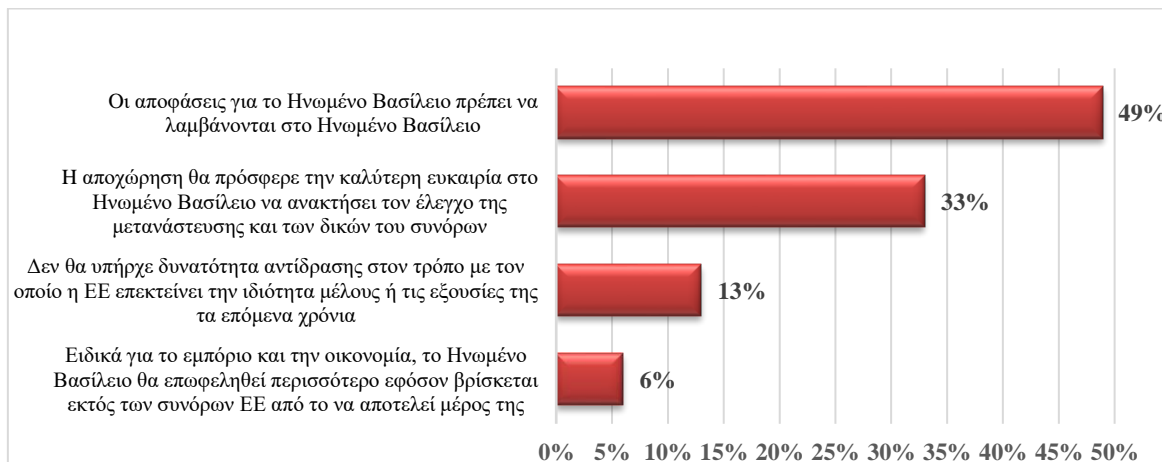

Πηγή: Lord Ashcroft (2016).

**Εικόνα 9. Λόγοι ψήφισης υπέρ της παραμονής στην ΕΕ στο δημοψήφισμα της Βρετανίας, στις 23 Ιουνίου 2016.**



Πηγή: Lord Ashcroft (2016).

Από τους ψηφοφόρους που ψήφισαν *κατά της αποχώρησης* (βλ. Εικόνα 9), ένα σημαντικό ποσοστό (43%) θεωρεί ότι ο σημαντικότερος λόγος για την απόφασή τους ήταν ότι «οι κίνδυνοι από την εγκατάλειψη της ΕΕ φαίνονταν υπερβολικά μεγάλοι ειδικότερα για την οικονομία, τις θέσεις εργασίας και τις τιμές των προϊόντων». Λίγο πάνω από τους τρεις στους δέκα (31%) υποστήριξαν ότι η παραμονή θα σήμαινε ότι το Ηνωμένο Βασίλειο θα έχει «τα καλύτερα από τους δύο κόσμους», έχοντας δηλαδή πρόσβαση στην ενιαία αγορά της ΕΕ, χωρίς το ενιαίο νόμισμα του ευρώ και χωρίς εφαρμογή της συμφωνίας του Schengen. Λιγότερο από ένας στους πέντε (17%) δήλωσε ότι ο κύριος λόγος παραμονής είναι ότι το Ηνωμένο Βασίλειο θα «απομονωνόταν περισσότερο από τους φίλους και τους γείτονές του», ενώ λιγότερο από ένας στους δέκα (9%) δήλωσε ότι «είναι ισχυρή η προσήλωση στην ΕΕ και την κοινή ιστορία, τον πολιτισμό και τις παραδόσεις της».

Από τις απαντήσεις αυτών που ψήφισαν κατά της παραμονής της χώρας στην ΕΕ προκύπτει ότι υπάρχει σε σημαντικό ποσοστό η αίσθηση δημοκρατικού ελλείμματος στην ΕΕ, με δεδομένο ότι οι τρεις από τις τέσσερις απαντήσεις που συγκεντρώνουν το μεγαλύτερο ποσοστό των αρνητικών ψήφων (95%), αναδεικνύουν την επικρατούσα άποψη των ψηφοφόρων αυτών ότι οι λαμβανόμενες από την ΕΕ αποφάσεις αποβαίνουν σε βάρος των συμφερόντων της χώρας, η οποία δεν έχει τη δυνατότητα να αποφασίζει για τον εαυτό της, να ελέγχει τα σύνορά της και να αποτρέπει «ασύμφορες» διευρύνσεις.

Ως προς τις ηλικιακές ομάδες των ψηφοφόρων που συμμετείχαν, σχεδόν τα τρία τέταρτα (73%) της ηλικιακής ομάδας από 18 έως 24 ετών, λιγότερο από τα δύο τρίτα (62%) της ηλικιακής ομάδας από 25 έως 34 ετών και λίγο περισσότερο από τους μισούς (52%) της ηλικιακής ομάδας από 35 έως 44 ετών, ψήφισαν υπέρ της παραμονής της χώρας στην ΕΕ. Κατά της παραμονής της χώρας στην ΕΕ ψήφισαν με ποσοστά 54%, 57% και 60% οι ηλικιακές ομάδες από 45 έως 54 ετών, από 55 έως 64 ετών και άνω των 65 αντίστοιχα (βλ. Εικόνα 10). Τούτο σημαίνει ότι οι μεγαλύτερες ηλικίες των ψηφοφόρων ψήφισαν αντίθετα προς τη βούληση των νεότερων ηλικιών της Βρετανίας, που αποτελούν το μέλλον της χώρας.

**Εικόνα 10. Ποσοστά ψηφοφόρων που ψήφισαν υπέρ ή κατά της παραμονής της Βρετανίας στην ΕΕ, στο δημοψήφισμα της Βρετανίας, στις 23 Ιουνίου του 2016, ανά ηλικιακή ομάδα.**

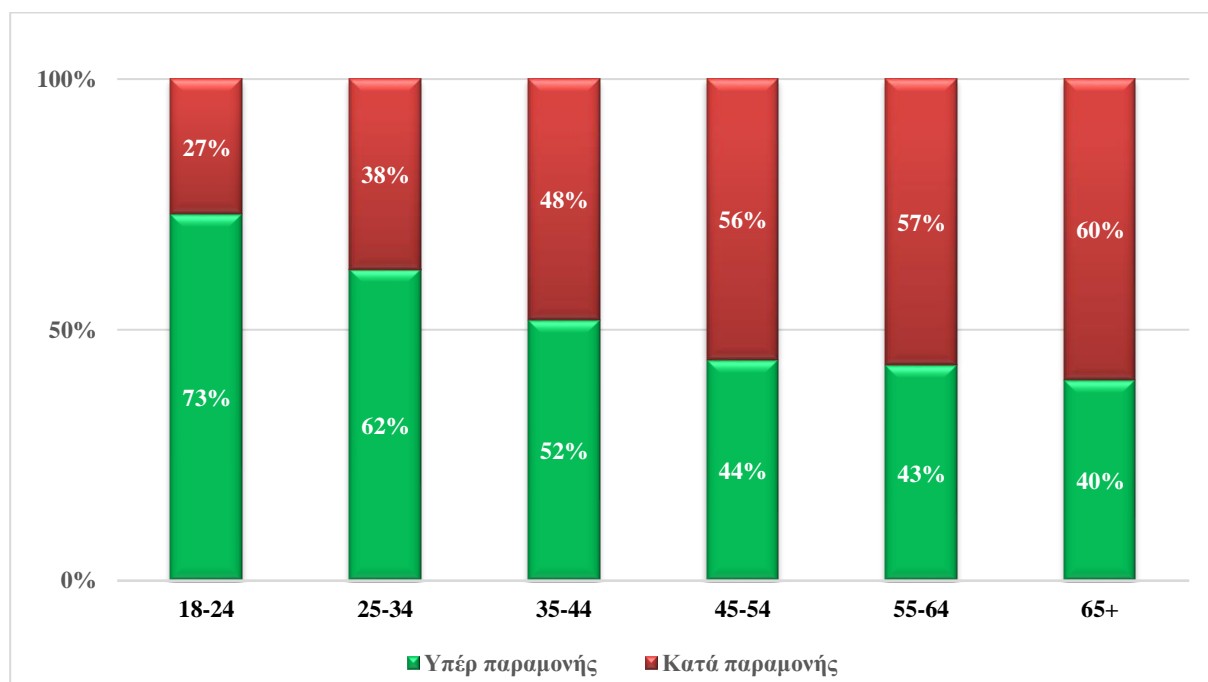

Πηγή: Lord Ashcroft (2016).

Ακόμη, σύμφωνα με έρευνα της YouGov (YouGov, 2016), ο πιο συχνά επιλεγμένος λόγος μεταξύ των ψηφοφόρων που ψήφισαν υπέρ της αποχώρησης από την ΕΕ, με ποσοστό 45%, ήταν «να επιτευχθεί καλύτερη ισορροπία μεταξύ του δικαιώματος της Βρετανίας να ενεργεί ανεξάρτητα και του κατάλληλου επιπέδου

συνεργασίας με άλλες χώρες». Ο δεύτερος πιο συχνά επιλεγμένος λόγος μεταξύ των ιδίων ψηφοφόρων, με ποσοστό 26%, ήταν «να αντιμετωπισθεί καλύτερα το ζήτημα της μετανάστευσης» (βλ. Εικόνα 11).

Επίσης, σύμφωνα με την ίδια έρευνα, ο πιο συχνά επιλεγμένος λόγος μεταξύ των ψηφοφόρους που ψήφισαν κατά της αποχώρησης από την ΕΕ, με ποσοστό 40%, ήταν «να υπάρξει βελτίωση για τις θέσεις εργασίας, τις επενδύσεις και την οικονομία γενικά». Ο δεύτερος πιο συχνά επιλεγμένος λόγος μεταξύ των ιδίων ψηφοφόρων, με ποσοστό 21%, ήταν «να επιτευχθεί καλύτερη ισορροπία μεταξύ του δικαιώματος της Βρετανίας να ενεργεί ανεξάρτητα και του κατάλληλου επιπέδου συνεργασίας με άλλες χώρες». (βλ. Εικόνα 12).

**Εικόνα 11. Λόγοι ψήφισης κατά της παραμονής στην ΕΕ στο δημοψήφισμα της Βρετανίας, 23/6/2016.**

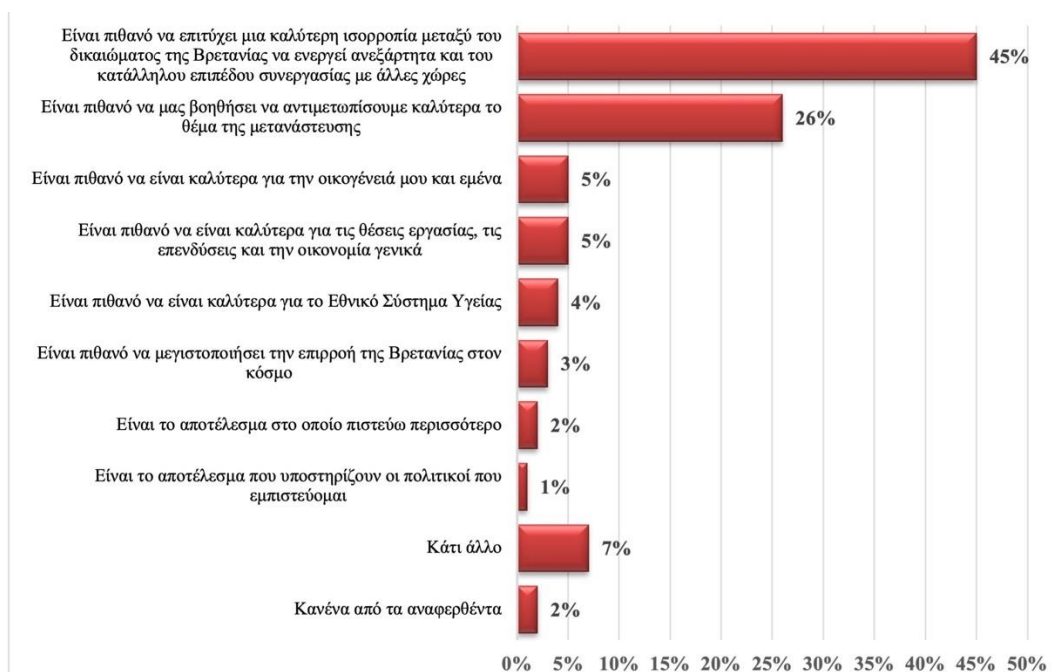

Πηγή: YouGov (2016).

Σημειώνεται ακόμη ότι ως προς τις ηλικιακές ομάδες των ψηφοφόρων που συμμετείχαν, το 75% της ηλικιακής ομάδας από 18 έως 24 ετών και το 56% της ηλικιακής ομάδας από 25 έως 49 ετών, ψήφισαν υπέρ της παραμονής της χώρας στην ΕΕ. Κατά της παραμονής της χώρας στην ΕΕ ψήφισαν με ποσοστά 56% και 61% οι ηλικιακές ομάδες από 50 έως 64 ετών και άνω των 65 αντίστοιχα (βλ. Εικόνα 13). Τούτο επιβεβαιώνει και πάλι ότι οι μεγαλύτερες ηλικίες των ψηφοφόρων ψήφισαν αντίθετα προς τη βούληση των νεότερων ηλικιών της Βρετανίας, που αποτελούν το μέλλον της χώρας.

**Εικόνα 12. Λόγοι ψήφισης υπέρ της παραμονής στην ΕΕ στο δημοψήφισμα της Βρετανίας, 23/06/16.**

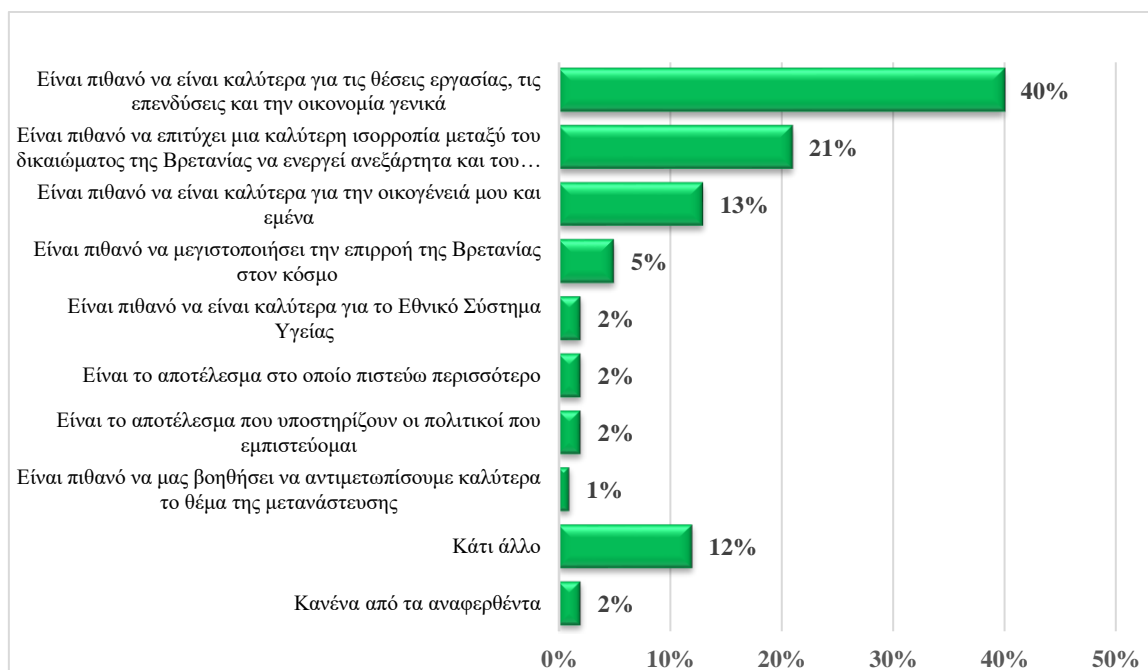

Πηγή: YouGov (2016).

Και σ' αυτή την περίπτωση, από τις απαντήσεις αυτών που ψήφισαν κατά της παραμονής της χώρας στην ΕΕ προκύπτει ότι υπάρχει σε σημαντικό ποσοστό η αίσθηση δημοκρατικού ελλείμματος στην ΕΕ, με δεδομένο ότι οι περισσότερες απαντήσεις που συγκεντρώνουν το μεγαλύτερο ποσοστό των αρνητικών ψήφων (90%), αναδεικνύουν την επικρατούσα άποψη των ψηφοφόρων αυτών ότι η συμμετοχή της χώρας στην ΕΕ αποβαίνει σε βάρος των συμφερόντων της χώρας.

**Εικόνα 13. Ποσοστά ψηφοφόρων που ψήφισαν υπέρ ή κατά της παραμονής της Βρετανίας στην ΕΕ, στο δημοψήφισμα της Βρετανίας, στις 23 Ιουνίου του 2016, ανά ηλικιακή ομάδα.**

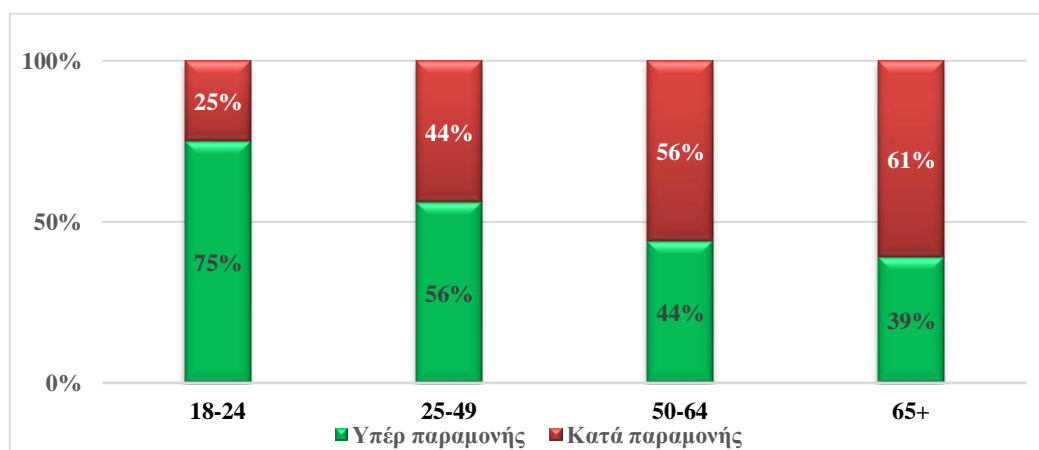

Πηγή: Lord Ashcroft (2016).

### 3. Συμπεράσματα

Από την προηγούμενη ανάλυση προκύπτει πρακτικά ότι το δημοκρατικό έλλειμμα ως έννοια εκφράζει την απομάκρυνση των θεσμών και των κέντρων λήψης των αποφάσεων της ΕΕ από τους πολίτες των κρατών-μελών, ενώ υποδηλώνει τις λειτουργικές στρεβλώσεις των οργάνων της ΕΕ που τα καθιστά απρόσιτα στον

μέσο πολίτη, καθώς ο τρόπος λειτουργίας τους θεωρείται από πολλούς ιδιαίτερα περίπλοκος. Η αντίληψη της παρουσίας αυτής της αίσθησης ύπαρξης δημοκρατικού ελλείμματος λήφθηκε σοβαρά υπόψη κατά την κατάρτιση των συνθηκών, με εμφανείς προσπάθειες μεταρρυθμίσεων των θεσμών της ΕΕ, ώστε να λειτουργούν με μεγαλύτερη διαφάνεια και λιγότερη γραφειοκρατία, καθώς και βελτίωσης του τρόπου λήψης των αποφάσεων ώστε αυτές να περιβάλλονται από την απαραίτητη δημοκρατική νομιμότητα.

Ωστόσο, οι απόψεις πολλών ερευνητών διαφέρουν ως προς την ύπαρξη, το μέγεθος και το είδος του δημοκρατικού ελλείμματος στην ΕΕ. Ορισμένοι, κυρίως θιασώτες της διακυβερνητικής συνεργασίας, αμφισβητούν την ύπαρξή του, οι φεντεραλιστές υποστηρίζουν ότι η ΕΕ πρέπει να μεταρρυθμίσει τα θεσμικά της όργανα ώστε να αποκτήσουν την απαιτούμενη δημοκρατική νομιμότητα και λειτουργική διαφάνεια, με τη συναίνεση των πολιτών των κρατών-μελών, για την κατάληξη σε μία μορφή ομοσπονδίας, ενώ οι ευρωσκεπτικιστές υποστηρίζουν ότι η ΕΕ θα πρέπει να μειώσει τις εξουσίες της οι οποίες στερούν από τα κράτη-μέλη και τους πολίτες τους τη δυνατότητα δημοκρατικής έκφρασης.

Η νομιμοποίηση του πολιτικού συστήματος της ΕΕ αποτελεί ουσιαστικά την επιβεβαίωση της δημοκρατικής της λειτουργίας. Αυτή θα μπορούσε να συνίσταται από την ύπαρξη συγκεκριμένων δημοκρατικών διαδικασιών λήψης και εκτέλεσης των αποφάσεων (νομιμοποίηση εκ των εισροών). Ωστόσο, σύμφωνα με άλλες απόψεις, η νομιμοποίηση μπορεί να συνίσταται στην ικανότητα του πολιτικού συστήματος να ενεργεί ρυθμιστικά και εκ του θετικού αποτελέσματος να συντηρεί την πεποίθηση ότι είναι το πλέον ενδεδειγμένο για το γενικό συμφέρον (νομιμοποίηση εκ των εκροών).

Επιπλέον, υφίσταται και η κοινωνικο-ψυχολογική διάσταση ως συνιστώσα της αίσθησης του δημοκρατικού ελλείμματος, που σχετίζεται με την κοινωνική αποδοχή και δημοκρατική νομιμοποίηση του συστήματος της ΕΕ και των θεσμών της από τους πολίτες των κρατών-μελών, στο βαθμό που οι ίδιοι θεωρούν τους εαυτούς τους ευρωπαίους πολίτες, που συνιστούν έναν ευρωπαϊκό δήμο, στον οποίο οι πολίτες έχουν μία διεθνική (ευρωπαϊκή) συνείδηση. Οι πολίτες αυτού του ευρωπαϊκού δήμου θα μπορούν να ανήκουν παράλληλα και σε άλλους μικρότερους δήμους, κρατικούς-εθνικούς και τοπικούς, φέροντας έτσι πολλαπλές ταυτότητες. Η φύση της ΕΕ, ως πολυεθνικό πολιτικό σύστημα που στηρίζεται σε μία θεσμικά πολυεπίπεδη και πολυκρατική συνύπαρξη, δεν αποκλείει τη διαμόρφωση ενός τέτοιου ευρωπαϊκού δήμου, ο οποίος θα συντίθεται από τους επιμέρους ευρωπαϊκούς λαούς, που θα ανήκουν σε επιμέρους κρατικούς-εθνικούς και τοπικούς δήμους και θα λειτουργεί ως μία πολυεθνική ευρωπαϊκή «δημοι-κρατία» (demoi-cracy).

Σφυγμομετρήσεις μέσω του Ευρωβαρόμετρου και άλλων ερευνών αποτίμησης αποτελεσμάτων δημοψηφισμάτων επικύρωσης συνθηκών ή ερωτημάτων παραμονής ή αποχώρησης από την ΕΕ, αναδεικνύουν έναν υποβόσκοντα ευρωσκεπτικισμό ανάμεσα τους πολίτες της ΕΕ, που οφείλεται, κατά την άποψή μας, στην ελλιπή ενημέρωση του ευρωπαίου πολίτη από τους θεσμούς της ΕΕ, και κυρίως, από τους πολιτικούς και τις κυβερνήσεις των κρατών-μελών, που για λόγους άλλοτε μικροπολιτικής ή λαϊκισμού και άλλοτε υπερβολικής βεβαιότητας για τη σύμφωνη γνώμη των πολιτών, δεν ενημερώνουν επαρκώς τους πολίτες παρέχοντας τα απαραίτητα στοιχεία για τα θετικά αποτελέσματα των συνθηκών προς την κατεύθυνση της



δημοκρατικοποίησης του πολιτικού συστήματος της ΕΕ ή των αρνητικών επιπτώσεων μίας αποχώρησης από την ΕΕ. Εάν προστεθεί και η απουσία γενικής γνώσης για τους σκοπούς, τους θεσμούς και τη λειτουργία της ΕΕ (εξευρωπαϊσμός;), η οποία θα έπρεπε να υφίσταται και ως μάθημα αγωγής ευρωπαίου πολίτη στη σχολική εκπαίδευση, τότε το θέμα της ύπαρξης αίσθησης δημοκρατικού ελλείμματος στην ΕΕ γίνεται περισσότερο κατανοητό.

### Βιβλιογραφικές Αναφορές

- Beetham D. & Lord C. (1999). Legitimacy and the European Union. In: Nentwich, M., & Weale (eds.), *A. Political Theory and the European Union*. London: Routledge, pp. 15-33.
- Βοσκόπουλος, Γ. (2009). *Η Ευρωπαϊκή Ένωση – Θεσμοί, πολιτικές, προκλήσεις, προβληματισμοί*. Θεσσαλονίκη: Εκδόσεις Επίκεντρο.
- Cederman, L.E. (2001). Nationalism and Bounded Integration: What It Would Take to Construct a European Demos. *European Journal of International Relations* 7(2): 139-174.
- Chrysochoou, D.N. (2007). Democracy and the European polity. In: Cini, M. (ed.), *European Union politics* (2nd ed.). Oxford: Oxford University Press.
- Dahl, R. A. (1998). *On Democracy*. London: Yale University Press.
- Dellavalle, S. (1993). Für einen normativen Begriff von Europa: Nationalstaat und europäische Einigung im Lichte der politischen Theorie. In: v. Bogdandy, A. (ed.), *Die europäische Option*. Baden-Baden: Nomos, p. 237.
- European Parliament (2008). *Working Document on Challenge of Democracy: empowering the EU citizen*, DT\755803EN.doc, 27.11.2008.
- Føllesdal, A., Hix, S. (2005). Why there is a Democratic Deficit in the EU: A Response to Majone and Moravcsik. *European Governance Papers*, No C-05-02.
- Hall, S. (2003). Το Ζήτημα της Πολιτιστικής Ταυτότητας. Στο: Hall, S., Held, D., McGrew, A. (επιμ.), *Η Νεωτερικότητα Σήμερα, Οικονομία, Κοινωνία, Πολιτική, Πολιτισμός*. Αθήνα: Σαβάννα.
- Hix, S. (2005). *The Political System of the European Union*. 2<sup>nd</sup> ed. London: Palgrave.
- Hix, S. (2008α). *Το πολιτικό σύστημα της Ευρωπαϊκής Ένωσης*. Αθήνα: Μεταίχμιο.
- Hix, S. (2008β). *What's wrong with the European Union and how to fix it*. Cambridge & Madlen, MA: Polity Press.
- Innerarity, D. (2014). Does Europe Need a Demos to Be Truly Democratic? *LSE 'Europe in Question' Discussion Paper Series*. London: London School of Economics and Political Sciences.
- Liebert, U. (2010). Contentious European Democracy: National Intellectuals in Transnational Debates. In: Lacroix, J., Nicolaidis, K. (eds.), *European Stories. Intellectual Debates on Europe in National LOrContexts*. Oxford: Oxford University Press.
- Lord Ashcroft. (2016). How the United Kingdom voted on Thursday... and why. *Lord Ashcroft Polls*. published online
- Majone, G. (1996). *Regulating Europe*. London and New York: Routledge.
- Majone, G. (1998). Europe's 'Democratic Deficit': The Question of Standards. *European Law Journal* 4 (1): 5-28.
- Majone, G. (2000a). The Credibility Crisis of Community Regulation. *Journal of Common Market Studies* 38 (2): 273-302.
- Majone, G. (2002). Delegation of regulatory Powers in a mixed Polity. *European Law Journal*, 8 (3): 319-339.
- Majone, G. (2000b). The European Commission: The Limits of Centralization and the Perils of Parliamentarization. *Governance* 15 (3): 375-392.
- Marquand, D. (1979). *Parliament for Europe*. London: Jonathan Cape Ltd.
- Mayer, F., Palmowski, J. (2004). European Identities and the EU – The Ties that Bind the Peoples of Europe. *Journal of Common Market Studies*, p. 573.
- Miller, D. (2000). *Citizenship and National Identity*. London: Blackwell.
- Μισσιρά, Δ. (2014). Νέα Οικονομική Διακυβέρνηση: Από το Δημοκρατικό Έλλειμμα στη Δημοκρατική Αθέτηση. Στο: ΙΕΚΕΘ (2013-2014), *Η σύγχρονη Ευρωπαϊκή Οικονομική και Κοινωνική Κρίση, το Δημοκρατικό Έλλειμμα και η Άνοδος του Ευρωσκεπτικισμού*. Αθήνα: Ινστιτούτο Έρευνας & Κατάρτισης Ευρωπαϊκών Θεμάτων.
- Moravcsik, A. (2002). In Defence of the 'Democratic Deficit': Researching the Legitimacy of the European Union. *Journal of Common Market Studies*, 40 (4): 603 – 634.
- Moravcsik, A. (2008). The Myth of Europe's Democratic Deficit. *Intereconomics, Journal of European Public Policy*, November-December.
- Μούσης, Ν. (2011). *Ευρωπαϊκή Ένωση: δίκαιο, οικονομία πολιτικές*. Αθήνα: Παπαζήσης.

- Nicolaidis, K. (2004). We, the peoples of Europe..... *Foreign Affairs* 83 (6): 97-110.
- Παπαδοπούλου, Α. (2011). Σκέψεις για το Δήμο και τη Δημοκρατία στην Ευρωπαϊκή Ένωση. Στο: Μανιτάκη, Α., (επιμ.), *Η Δημοκρατία μεταξύ Ουτοπίας και Πραγματικότητας, Μελέτες Χαριστήριες στον Ζήση Παπαδημητρίου*. Αθήνα: Σαββάλας, σελ. 152-174.
- Radaelli, C. (2003). The Europeanization of Public Policy. In: Featherstone, K., Radaelli, C. (eds.), *The Politics of Europeanization*. Oxford: Oxford University Press, pp. 27-56.
- Schmidt, V.A. (2013). Democracy and Legitimacy in the European Union Revisited: Input, Output and “Throughput”. *Political Studies*, 61: 2-22.
- Schmidt, V., & Radaelli, C. (2004). Policy change and discourse in Europe: conceptual and methodological issues. *West European Politics*, 27(2):183–210.
- Στεφάνου, Κ.Α. (1996). *Η Θεσμική Μεταρρύθμιση της Ευρωπαϊκής Ένωσης*. Αθήνα: Παπαζήσης.
- Weiler, J.H.H. (1991). The Transformation of Europe. *The Yale Law Journal*, 100: 2403.
- Weiler, J.H.H. (1995a). Demos, Telos and the German Maastricht Decision. *European Law Journal*, 224-245.
- Weiler, J.H.H (1995b). Does Europe Need a Constitution?, Demos, Telos and the German Maastricht Decision. *European Law Journal*, 219.
- Weiler, J.H.H. (1999). *The Constitution of Europe*. London: Cambridge University Press.
- Williams, S. (1990). Sovereignty and Accountability in the New European Community. *The Political Quarterly*, 61 (3): 299–317.
- Χρυσοχόου, Δ. (2007). *Σχεδίαση Μετακρατικής Πολιτείας*. Αθήνα: Παπαζήσης.
- YouGov. (2016). On the day poll [Sample Size: 4772 UK Adults; Fieldwork: 23rd June 2016]. YouGov, published online.
- Zweifel, T.D. (2002). *Democratic Deficit? Institutions and Regulation in the European Union, Switzerland, and the United States*. New York: Lexington Books.

## **TOPIC 2: EU DEFENCE AND INTERNATIONAL SECURITY**

## **2.1. The security challenges that the EU is facing in cyberspace**

*Eleni Kapsokoli<sup>1</sup>*

### **Abstract**

Cyberspace is a new challenge for the global security and stability and poses numerous threats for the protection of national critical infrastructures. This paper analyses the way the European Union adjusts to these threats, by adapting new policies and establishing the development of relative institutions regarding cybersecurity and cyber-defence. The aim is to critically assess the ability of the EU to act as a reliable security provider in cyberspace. Recent developments indicate that the EU needs to overcome its institutional fragmentation and become a resilient actor in cyberspace.

**Keywords:** EU, NIS, ENISA, cybersecurity, cyber-defence, cyber-resilience.

### **Introduction**

Cyberspace is a complex and multi-dimensional domain with technological and socio-political characteristics (Craig, Diakun-Thibault & Purse, 2014). Trying to understand this domain is challenging, since there is no common and widely accepted definition that reflects its characteristics, its multidimensional nature and the securitization of that domain (Luijck, Besseling & De Graaf, 2013). The digital era has provided us with direct communication, where everything is connected and synchronized. We are becoming more and more dependent from the use of cyberspace. Information technology affects every human, social, economic and political aspect, but has also caused the emergence of new threats. Users of cyberspace exceed four billions worldwide, making this new domain a necessary one, to achieve transactions and exchanges of information and data.

In the rapidly changing field of security, states are called upon to respond immediately, not only to traditional threats, but also to new ones, like hybrid warfare and cyberterrorism, that originate from both state and non-state actors. Countering such threats forces the EU to adopt a common security and defence strategy. Cyberattacks are threatening not only the critical infrastructure, but they also target political and human rights.

Over the last few years, the EU has recognized the growing threats that arise from the nature of our digital world, which depends on automation and access to data (EEAS, 2016). Indicate of the above, the 2016 EU Global Strategy highlights “cyber” as one of the key elements of EU political agenda. Thus, the EU has assumed cybersecurity responsibility for its member-states with an integrated cybersecurity strategy that will strengthen the principle of resilience, mitigate cyber threats and explore all the benefits of digital

---

<sup>1</sup> PhD Candidate, Department of International & European Studies, University of Piraeus, School of Economics, Business and International Studies, Laboratory of Intelligence and Cybersecurity. Email: ekapsokoli@unipi.gr / elenikapsokoli1989@gmail.com

transformation. In the EU, member-states are responsible for their own cyber capacities. As a result, they have developed different levels of maturity in a relation to cybersecurity (ENISA, 2014).

Indicative of the above, is the fact that the EU lacks a common approach of the terms “cybersecurity” and “cyber-defence” (Sliwinski, 2014). The former is a hard to define term, since the nature of threats in cyberspace are constantly evolving. The latter relates to actions that combine information assurance, computer network defense and capabilities that enable a state to prevent, deter and respond to an adversary. The lack of conceptual clarity hinders the implementation of a common approach on security and defence in cyberspace.

The EU first addressed the cyber risks in the Cybersecurity Strategy of 2013. In September 2017, the EU updated the Cyber Security Strategy, which intends to improve the protection of its vital infrastructure. However, the new strategy leaves open a series of questions about how its target for an “open and secure cyberspace” will be achieved both internally and externally. The EU has not sufficiently defined its approach on resilience or deterrence, nor how it intends to overcome the institutional fragmentation and lack of legal authority on cybersecurity issues.

In order to analyze the EU cybersecurity and defence strategy, we will make a short reference to certain cyberattacks that affected EU’s policies (e.g. the cases of Estonia and Georgia). After that we will briefly review EU’s cybersecurity policy, by examining the strategies of 2013 and 2017. Following that, we will analyze the institutions that the EU has developed in the field of cybersecurity and cyber-defence (e.g. ENISA, NIS Directive, European Cybercrime Centre (EC3)). Finally, in order to have a more complete understanding of the cybersecurity developments in Europe, it is necessary to examine the EU-NATO cooperation in regard to cybersecurity.

### **The EU’s cyber-maturity**

For a long time, cybersecurity remained in the hands of a small group of experts. Nowadays, governments, businesses, societies and the armed forces need to develop a more sophisticated understanding of these challenges in order to adopt efficient strategies. Due to the wide development of cyberspace, cybersecurity entails not only technical dimensions, but also political and strategic ones. The start of a collective effort within the EU to understand the unique characteristics of this domain were the cyberattacks in Estonia (2007) and Georgia (2008) (Saleem & Hassan, 2019). These attacks were the starting point for a number of policies, both transnational and multinational, to address these new threats.

The case of Estonia (Saleem, Hassan & Vihul, 2010) in 2007 involved a series of three-week cyberattacks aimed at downgrading the country’s information infrastructure. The targets were the Presidency, the Parliament, the ministries, the political parties, the media, the banks and the telecommunications. A year later, in August 2008, Georgia’s critical infrastructure received a series of cyberattacks (Tikk, Kaska & Vihul, 2010) in the context of a military confrontation with Russia. As a result, government websites could not be accessed

and their content was replaced. Georgia was unable to shape the narrative and therefore unsuccessful in affecting the national and global public opinion.

These events served as a wake-up call for the EU, proving that national critical infrastructures are vulnerable in a field, that is not limited by geography. Cyberattacks have a high social and political impact by threatening the resilience and functioning of the modern state. The EU did not immediately adopt a common strategy on cybersecurity, but member-states have developed national strategies. Security dilemmas and the lack of trust between member-states made it difficult to formulate a common strategy.

The EU started developing the first comprehensive cybersecurity strategy in 2012-2013. The development of this strategy demonstrates that the EU has realized the importance of cybersecurity and the significance of resilience in addressing cyber threats. The first coherent text of the EU strategy on cybersecurity was announced in 2013, entitled “Cybersecurity Strategy of the European Union: An Open, Safe and Secure Cyberspace” (EUCSS, 2013). It includes six strategic priorities: 1) to achieve cyber-resilience; 2) to reduce cybercrime; 3) to develop a cyber-defence policy and capabilities related to the Common Security and Defence Policy (CSDP); 4) to develop industrial and technical resources to prevent and deter cyber incidents; 5) to develop international cyberspace policy and 6) to promote the EU’s core values both in the digital and the physical world. The EUCSS is highly promising and through the years of its adoption, the EU has made progress in all policies. Nevertheless, the goal of a wider cooperation between national and international actors, that involve both the private sector and the civil society, has not been achieved yet.

In the Cyber-Defence Policy Framework adopted in 2014 (Rehrl, 2019), the European External Action Service (EEAS) is responsible for cyber-defence and has the following objectives: 1) to support the development of CSDP-related cyber-defence capabilities; 2) to enhance the protection of CSDP communication networks; 3) to promote political and military cooperation and synergies with broader EU policies, EU institutions and services and the private sector; 4) to improve training and 5) to enhance cooperation with relevant international partners, in particular with NATO. In addition, the above policy framework identifies three key pillars to tackle cyber threats: 1) network and information security by developing public-private partnerships (PPPs) at the international level, 2) law enforcement by adopting a directive to tackle information systems attacks through strengthening the national legislation of the member-states on cybercrime, 3) developing cyber-defence as a key objective of the Common Security and Security Policy (CSSP) in cooperation with the European Defence Agency (EDA) and the member-states. The EEAS concept paper on cybersecurity in civilian missions has suggested creating a focal point for cyber issues in the Civilian Planning and Conduct Capability (CPCC) to ensure and enhance the security and defence. In line with this, the CPCC appointed a new officer in September 2017 who deals mainly with cyber-defence capabilities enforcement and cybersecurity coordination for civilian missions (Rehrl, 2019).

In September 2018 (Rehrl, 2019), the European Commission proposed the creation of a Network of Cybersecurity Competence Centre and a new European Cybersecurity Industrial Technology and Research

Competence Centre to invest in stronger cybersecurity in the EU. The main purpose of the above proposal is to build cybersecurity, technological and industrial capacities to secure digital single market.

As per the New Digital Europe Programme by the European Commission for the period 2021-2027 (Rehrl, 2019), the EU will invest 9.2 billion to create a cybersecurity industrial and research ecosystem that will be interconnected widely in Europe. This program will enhance cooperation between relevant stakeholders (create more than 600 cybersecurity expertise centres across the EU), to create a more proactive, long term and strategic approach to cybersecurity, to develop research and innovation in order to close the gaps of education.

The range of “NotPetya” (2016), “Mirai botnet” (2016) and “WannaCry” (2017) ransomware cyberattacks have underscored the vulnerability of EU’s information infrastructures and have prompted member-states to review their actions and adopt a more proactive approach. These large scale incidents targeted key areas such as energy, transport and health. As European Commission President Jean Claude Juncker said: “Cyberattacks can be more dangerous than the stability of democracies and economies than guns and tanks” (European Commission, 2017a).

The revised EU Cybersecurity Strategy was adopted in September 2017 (European Commission, 2017b). The core of this strategy is “a Europe that is resilient, which can protect its people effectively by anticipating possible cybersecurity incidents, by building strong protection in its structures and behavior, by recovering quickly from any cyberattacks, and by deterring those responsible”. It includes five key priorities: 1) creating a European research and competency centre for cybersecurity; 2) establishing a Europe-wide crisis-response mechanism to deal with future large scale cyberattacks; 3) creating a cybersecurity emergency fund; 4) developing common projects in military cyber-defence as part of the Permanent Structured Cooperation and with the help of the European Defence Fund and 5) promoting confidence-building measures and state responsibility, so as to contain cyber risks worldwide. All the above intend to build better cyber resilience, deterrence and strategic autonomy, enhancing cyber capabilities and build a strong single market (Bendiek, Bossong & Schulze, 2017).

Although the Strategy of 2017 is moving in the right direction by trying to build cyber-resilience, the EU has not yet sufficiently defined the concepts of resilience and deterrence, nor has it set out how it intends to overcome institutional fragmentation and lack of effective control over cybersecurity.

Another major problem of the EU is the lack of trust and cooperation between member-states. No policy will be successful without transnational trust and the exchange of useful information and best practices. Member-states must work together to achieve strong cybersecurity, abandon their national strategies and create a digital autonomy. The above will only be successful with the development of open source, decentralized software and the use of cyber-encryption. The growing vulnerability of infrastructures to cyberattacks or software errors can be tackled by voluntary cooperation and technical innovation (Bendiek, Bossong & Schulze, 2017).

The revised EU strategy contains only a few additions to international rules defining the behavior of states in cyberspace. Regarding the protection of its information infrastructures, the EU embrace a more active role. Finally, it stresses the need for further bilateral agreements between the EU and third countries on countering cyber threats.

### **The institutional build-up of the EU in cyberspace**

Over the past decade, the EU has established a number of institutions, that aim to provide its member-states with the necessary cybersecurity and cyber-defence capabilities. The main institutions assigned with the cybersecurity and cyber-defence tasks are EDA, ENISA, NIS Directive, EC3, CERT-EU and the European Cybersecurity Competence Centre which will be presented below.

#### **European Defence Agency (EDA)**

The EDA was adopted in 2004 by the European Council in order to improve the defence capabilities of the EU and has become the hub of European cooperation on cyber issues (Rehrl, 2019). The EU Cybersecurity Strategy of 2013 requires cyber-defence capabilities and technologies to address all aspects of capability development including doctrine, leadership, organization, personnel, training, technology, infrastructure, logistics and interoperability.

On 2014, the European Council adopted the Cyber Defence Policy Framework (CDPF), which proposed 43 different work strands. Also, the EDA was given responsibilities in: 1) supporting the development of EU cyber-defence capabilities related to the CSDP; 2) promoting civil-military cooperation and synergies between EU institutions and the private sector; 3) training, education and exercise opportunities for the member-states; 4) cooperation with related international partners (NATO, UN, etc.) (Rehrl, 2019).

The strategy points out the EU Military Staff (EUMS) and the European Security and Defence College (ESDC) for the coordination and close cooperation between EDA, ENISA and Computer Emergency Response Team (CERT EU) and the EC3. The EDA also cooperates with the EEAS, the European Commission and the relevant EU agencies and bodies as well as liaising closely with NATO and its Cooperative Cyber Defence Centre of Excellence (CCDCOE).

One of the first priorities of EDA is the Capability Development Plan (CDP) which was updated on June 2018 and enhances cooperation in the cyber-defence domain. The main focus of the CDP is: 1) the support of member-states in military cyber-defence capabilities; 2) the development of proactive and reactive cyber-defence technology; 3) the wider cooperation with other organizations.



In such a challenging environment, the EDA will continue to support member-states in their efforts to build effective cyber-defence capabilities which will be accomplished by platforms for cooperation, like the Cyber Defence Project Team and the Ad Hoc Working Group (AHWG) for Cyber Defence Research.

In May 2018 a Memorandum of Understanding (MoU) was signed between EDA, ENISA, EC3 and CERT-EU aiming to establish a cooperation framework by exchanging expertise and best practices in the areas of cybersecurity, cyber-defence and cybercrime investigation.

### **European Network and Information Security Agency (ENISA)**

ENISA has been operating as a center of expertise since 2004. Its main purpose is the enhancement of the security of information systems and supporting the capacity building of member-states (European Commission, 2017c). In 2015, ENISA in its report titled “Defining Cybersecurity - Gaps and Duplications in Standardization”, explored how member-states and relevant organizations can define the concept of cybersecurity. ENISA also identifies the areas that include the term cybersecurity, such as the security of communications and information system, business security, physical security, public and national security (Helmbrecht, Purser & Ritter Klejn, 2012).

The organization uses a pyramid that reflects five layers of cybersecurity (ENISA, 2017a), presenting the EU’s holistic and multi-faceted approach to cybersecurity (see figure 1). The base of the pyramid refers to the protection of cyberspace users. Measures have to be adopted in order to deter the risks through proper education, information and hygiene in cyberspace. Users need to be aware of the dangers that exist in cyberspace, to protect and deal with them effectively. The second layer concerns the protection of critical infrastructure. The NIS introduces new security requirements for the protection of EU’s critical information infrastructures, such as energy, banking and transport, which form the basis for the functioning of modern society. At the third layer, we find the safeguarding of the digital single market. The protection policy consists of measures to deal with cyber threats to businesses, such as cybercrime, cyber espionage and cyber sabotage. The fourth layer introduces the task of global stability protection. Given the nature of cyberspace, this implies the adoption of international standards and the exercise of cyber diplomacy in order to ensure global stability. At the top of the pyramid are the key measures to protect democracy and human rights. A contemporary challenge is the protection of human rights in the digital environment. The adoption of adequate cyber security measures will reduce the negative impact of new technologies. Every new technology must not undermine social values, human rights, freedom and democracy (ENISA, 2017).

**Figure 1. Layers of cybersecurity protection.**



ENISA emphasizes that cyber security is based on information and network security thereby covering among others the principles of prevention, resilience, adaptability, confidentiality and survivability (ENISA, 2017a). ENISA's approach on cybersecurity is not widely accepted throughout the EU, as most member-states give different interpretations, thus drawing up national strategies rather than a common one. Nevertheless, in June 2018, the Council agreed to upgrade ENISA to a permanent EU cybersecurity body, as well as a mechanism to establish common European cybersecurity certification systems for specific ICT processes, products and services. ENISA's priorities (Rehrl, 2019) include the protection of critical information infrastructure, capacity building, product standardization and certification and exchange of information and best practices.

ENISA organizes annual exercises to simulate cyberattack incidents to develop an immediate and effective response to cybersecurity crisis management. These exercises are attended by the private sector, the competent bodies and the member-states. Over 600 organizations across Europe participate in the "Cyber-Europe" exercise every two years and over 200 experts participate in cyber security exercises annually. The European Commission's most important task for ENISA is undoubtedly the production of "candidates" for the certification of products and essential services to the digital single market. In order to have a more active role in supporting member-states, ENISA must have immediate and comprehensive access to the necessary information to carry out cyber incident analysis when requested.

### **Directive on Security of Network and Information Systems (NIS Directive)**

The Directive is the first EU legislative instrument that was adopted in July 2016, to combat cyber threats and provides legal measures to enhance cybersecurity (European Commission, 2017a). The Directive is at the heart of the principle of cyber-resilience, but also the cornerstone of the EU's overall effort in cyberspace. It is a set of standards for EU member-states in cybersecurity and can lead to upgrading capabilities, preparedness and

effective risk management and enhancing cooperation and communication between member-states through exchange of information and best practices (European Commission, 2018).

The four cornerstones of the Directive are (Rehrl, 2019): 1) improving national cybersecurity capacity by adopting effective national strategies; 2) improving cooperation between member-states, the Commission and ENISA regarding information sharing and confidence building; 3) providing security and notification requirements for operators of essential services and 4) offering security and notification requirements for digital service providers.

The Directive requires all member-states to set up a national response system to cyberattacks and to set up CERTs. Thus, the Directive sets out the responsibility of member-states not only to exchange information and best practices on cyber incidents at the EU level, but also to develop and jointly implement appropriate national cybersecurity strategies (European Commission, 2017b).

In the field of deterrence, the European Commission is also working to ensure full implementation of NIS 2013/40/EU (European Union, 2013) on attacks against information systems. The objectives of this Directive are to impose effective and dissuasive criminal penalties on information systems in all member-states and to improve and encourage cooperation between the competent authorities.

### **European Cybercrime Centre (EC3)**

An effective cybercrime management requires harmonization of legal, regulatory and technical provisions concerning the protection of personal data, privacy and the interests of legal persons (Mercado Kierkegaard, 2008). As per the Cybersecurity Strategy of 2013, the second pillar is dedicated to fighting cybercrime, which entails: “a broad range of different criminal activities where computers and information systems are involved either as a primary tool or as a primary target. Cybercrime comprises traditional offences (e.g. fraud, forgery, and identity theft), content-related offences (e.g. on-line distribution of child pornography or incitement to racial hatred) and offences unique to computers and information systems (e.g. attacks against information systems, denial of service and malware)” (European Council, 2013).

This is a wide definition which includes, not only crimes that are unique to electronic networks, such as cyberattacks, but also the use of information systems to pursue crimes such as fraud, or the publication of illegal content, or even online fundraising and recruitment for the contact of terrorism attacks (including “cyber terrorism”). While the EUCSS has put forward this definition of cybercrime, there is still no common understanding within the EU and therefore its member-states continue to apply their own definitions. Moreover, since cybercrime involves such a wide range of different acts, it has been debated whether there needs to be a single definition.

In 2013, the EU established the EC3, as a distinct body attached to Europol. It is a small unit that coordinates cross-border law enforcement and acts as a centre for sharing of technological expertise (Sliwinski, 2014). The EC3 coordinates national cybercrime authorities and the training of national cybersecurity experts and acts as

a European focal point in fighting cybercrime. Its main purpose is to ensure a coordinated response to cybercrime, to facilitate information exchange, to conduct forensic analysis, to provide intelligence and legal assistance, to provide support to member-states in cybercrime investigations and to promote meetings with cybercrime experts (Dunn Cavelty, 2018).

The EC3 has a holistic perspective to ensure and to counter cybercrime. It comprises three different units: operations, strategy and forensic expertise. There are five different teams, including three analysis projects (APs) (Rehrl, 2019): the first team (AP Cyborg) focuses on dependent cybercrime; the second team (AP Terminal) focuses on payment fraud; the third team (AP Twins) focuses on online Child Sexual Abuse (CSA); the fourth and the fifth teams are the Cyber Intelligence Team and the Dark Web Team. Both cut across the different operational teams and support them. The main purpose of the operational teams is to support the member-states to combat cyber threats, to lead and to coordinate a number of recurring actions. The teams are supported by specialized Europol staff, they use advanced techniques and software and their knowledge and expertise to find vital clues.

The investigation of cybercrime also requires capabilities in the area of forensics. Within the EC3's Forensic Expertise Unit (Rehrl, 2019), various specialists therefore assist member-states with digital forensics as well as document forensics, with a focus on operational support and research and development. The third unit of EC3, the Strategy Unit, focuses on the strategic elements of fighting cybercrime.

Although cybercrime and the criminal abuse of cyberspace continue to take place, the law enforcement response has some success. Due to the support and coordination of Europol, law enforcement agencies across the EU and beyond have demonstrated a coordinated and adaptive approach in fighting cybercrime.

### **Computer Emergency Response Team (CERT)**

Another key actor on EU's cyber-defence are CERTs or Computer Security Incident Response Teams (CSIRTs). In September 2012, the EU set up its own permanent CERT-EU, which has a defensive approach and plays an internal and technical role. Its mission is to support EU institutions to protect themselves against intentional and malicious attacks that would hamper the integrity of their critical infrastructure. The scope of CERT-EU's activities includes the elements of prevention, detection, response and recovery (Sliwinski, 2014).

The structure of CERTs diverges significantly both in form and function at the national level. In each state, there can be a number of CERTs ranging from companies, banks, regional governments, national governments, etc. There is also wide variance in capability between member-states, therefore there are only ten national CERTs in the European Government CERTs (EGC) group, due to lack of trust. In addition, international CERT cooperation occurs through the CSIRT Network (both CERT-EU and ENISA are members), a task force aimed at cooperation in Europe and neighbouring regions (TF-CSIRT) and globally through entities such as the Forum of Incident Response and Security Teams (FIRST) (Pupillo et al. 2018).

Since 2016, CERT-EU has signed a technical agreement with its NATO counterpart, the Computer Incident Response Capability (NCIRC), which facilitates technical information sharing between these two bodies (Rehrl, 2019).

### **European Cybersecurity Competence Centre**

On 13 September 2017, the European Commission adopted a Cyber Security Package, which includes a series of initiatives to further improve the resilience, deterrence and defence of cybersecurity incidents. In September 2018, the European Commission presented its proposal for the establishment of the European Cyber Security Competence Centre (Negreiro M. & Belluomini, 2019).

This initiative aims to improve and enhance the EU's cyber capability, encouraging European technological innovation in the field of security. This center will act as an additional support to existing cybersecurity actors such as ENISA and will coordinate the financial resources assigned to cybersecurity projects through the programs, "Digital Europe" and "Horizon Europe 2021-2027".

The center will create a new EU structure to pool and share cybersecurity research capabilities, which remain weak and fragmented. On the one hand, the center will facilitate and coordinate the work of the network to develop member-states' cyber capabilities, promoting technological development and security expertise. On the other hand, it will promote regular dialogue with the private sector, consumer organizations and member-states, enabling the creation of an industrial and scientific advisory board based on the impact of the existing Certificate Program in Public Procurement (CPPP) on cybersecurity. In addition, the center aims to support research, as well as facilitate and accelerate the process of standardization and certification of cybersecurity systems. It will also strengthen and support member-states by providing advice, exchanging best practices, experiences and information, facilitating cooperation and joint action.

### **EU-NATO Cyber Cooperation**

Another important goal of the EU cyber-defence and cybersecurity policy is the cooperation with key partners, such as NATO. The cooperation between EU and NATO is very important especially in the field of cybersecurity. Both institutions will continue to face new challenges and they are still maladapted to the new security environment. The EU and NATO are targeted by the very same vectors (state and non-state actors) who try to undermine all levels of society.

Cybersecurity and cyber-defence have long been part of their political agenda. The first largescale cyberattack in Estonia, forced both institutions to develop relevant policies. In 2008, NATO developed its first Cyber Defense Policy and five years later, the EU followed by adopting its first Cybersecurity Strategy in 2013. The EU is committed to promote social responsibility and transparency, to portray cyberspace as an area of freedom and fundamental rights, and to launch international cooperation and initiatives in the field of cybersecurity (International Business Publications, 2013).

NATO's cyber-defence role splits into two broad themes. The first priority is the protection of its own networks, as agreed in the NATO Summit in Wales in 2014. The second priority is to assist its members in developing their own cyber-defence capabilities. In this context the EU and NATO have started to work as complementary partners in order to build up their cyber resilience.

The year 2016 was a milestone for a safer EU in cyberspace. In February 2016 (Rehrl, 2019), the latest agreement on cyber-defence was signed between the EU and NATO, the Computer Emergency Response Team of the EU (CERT-EU) and NATO's Computer Incident Response Capability (NCIRC) in order to exchange technical information and address cyber threats. On July of the same year, the EU-NATO Joint Declaration (European Council, 2016) set out specific goals to promote cooperation by encouraging interoperability of cyber-defence missions and operations, enhancing training and joint training, technological research and innovation, hybrid threat response and crisis management (European Union External Action, 2018).

Currently, NATO and the EU have been cooperating on more than seventy parameters. Some of these include measures to increase the resilience to hybrid threats, cyberattacks and misinformation campaigns. As regards cyber-defence, the response teams of both NATO and EU regularly exchange updates, information, policies and best practices (NATO, 2018). Since September 2017, cooperation between the EU and NATO has strengthened, with the establishment of the European Center of Excellence to Combat Hybrid Threats (HybridCoE) (Rehrl, 2019).

Additional tasks include consulting on security and finding solutions on how member-states can improve their civil-military capabilities. The center reinforces the resilience of member-states to their readiness for cyberattacks and cyber threats through simulation exercises. In addition, the Center is looking for best ways to build solidarity, cooperation, communication and exchange of information and best practices between member-states.

In the face of common challenges, the EU and NATO member-states signed a joint statement in July 2018, which outlined the hybrid threats and the need for cybersecurity through enhanced cooperation and interoperability (Rehrl, 2019). The CERT-EU, the EEAS, the Information Center, the Hybrid Composition Sector, the EDA and the European Union Military Staff organize regular meetings and discussions on harmonizing their policies and exchanging best practices.

For the time being, the EU must accept NATO's supremacy in the field of cybersecurity and cyber-defence. NATO's mission focuses on the protection of its member states and its allies, and therefore performs tasks like collective defence and deterrence, crisis management, security and protection of critical infrastructure.

NATO supports its members in enhancing cyber-defence through joint cybersecurity exercises such as NATO Cyber Coalition, Cyber-Europe in partnership with ENISA, and EU-NATO Parallel and Coordinated Exercises (PACE) (Rehrl, 2019).

Despite political agreement to work together, EU-NATO cyber cooperation remains difficult, for three reasons (Lété & Pernik, 2017: 2): 1) lack of shared situational awareness and information sharing; 2) different levels of preparedness and cyber resilience and 3) no joint exercises, training and education.

Although NATO has many common actions with the EU in the field of cybersecurity, the alliance has its own policy and strategy in this area. The EU's approach is not as military as NATO's. In fact, the main areas of interest and responsibility for cybersecurity issues consist mainly of certain internal security issues, such as data protection, cybercrime, the digital market, electronic rights and cyber diplomacy (Pernik, 2014).

The main responsibilities of defence and security lie within the member-states themselves, while the EU institutions assist, advise, facilitate and support them. Thus, the EU has a consultative role, it is a regulator and a legislator and has no active role. As far as cyber-defence is concerned, member-states are based on NATO capabilities (Pupillo et al. 2018).

Compared to NATO, the EU is delaying the development of an integrated cybersecurity and defence policy. The EU is faced with issues of institutional fragmentation, lack of trust between the member-states, lack of funding and human resources and the absence of a strategic vision. The EU has therefore largely an advisory role and acts as a regulator, rather than having a strategic or an operational role. Its role focuses on cooperation and coordination of the member-states, the harmonization and standardization of policies and the development of capabilities on defence and security.

The task for the EU and NATO is to reach consensus regarding the transatlantic cooperation in the area of cybersecurity. First of all, they can create an EU-NATO Cyber Threat Analysis Hub (Lété & Pernik, 2017), which would monitor and analyze cyber threats, in order to provide enriched output at the operational and strategic levels. They have already worked together in joint structures through the European Centre of Excellence for Countering Hybrid Threats in Helsinki. Secondly, they can address the technology gap between the public and the private sector and reduce their vulnerability to cyber threats by creating a joint committee for cyber research and technology innovation. This will only be achieved by information sharing. Thirdly, they have to develop a peer assessment process to address key gaps in the cybersecurity, cyber resilience and cyber-defence of NATO and the EU. Moreover, the EU-NATO cyber crisis response mechanisms are limited, therefore the solution for collective response is to establish a Joint Working Group to synchronize crisis response systems. Last but not least, the creation of joint EU-NATO cybersecurity and cyber-defence exercises will enhance the cooperation, common situational awareness, collective decision-making and information sharing. Finally, the development of a joint response to cyberattacks by the EU and NATO will be crucial for the security of its member-states. To conclude, the focus of the EU-NATO cooperation is to find solutions in three areas that remain contentious: common situational awareness, collective decision making and information sharing.

### **Concluding remarks**

Cyberspace reflects the current international system, where ideologies, national and economic interests and geopolitical antagonisms inevitably clash. But, it is also an area in which states may choose to cooperate with one another to ensure international order and security. Cyberspace raises a number of security challenges that cannot be ignored in developed societies due to their increased dependence on ICTs. In the cyber age, anonymity fades, personal data is vulnerable, and security is uncertain. Modern democracies, in their quest to balance human rights protection with privacy and national security, tend to become digital surveillance states. After all, the work of national security and intelligence services is largely dependent on tracking our digital footprint.

Cyber actors are constantly evolving their tools and strategies, making the most of the benefits of information technology and the interconnectedness of societies. In this context, cooperation and mutual trust is a one-way street on the digital path that the EU is taking. A prerequisite for cooperation and effective capacity building is trust. Trust building between the different stakeholders, from both the public and the private sectors, requires extensive dialogue, mutual activities and exercises. Trust also can be achieved by PPPs, which can play a significant role.

Successful implementation of the resilience principle requires a deeper commitment by member-states to cooperation and trust. The resilience principle - a key issue in the 2013 and 2017 cybersecurity strategies - needs a clearer wording. The development of open source software, the existence of decentralized networks and the use of encryption make the information system robust. A durable system can withstand the loss of individual building blocks. A holistic approach to the resilience principle will represent the whole of society (economic, social and political actors) and will include a single market for cybersecurity.

To achieve all the above, IT product certification and the establishment of a single market for digital products, are vital developments that have to take place in the near future. Adding to that, cyber hygiene, inadequate cybersecurity education and human resources are key challenges that the EU is facing. As the Strategy of 2017 mentions, cybersecurity is crucial not only for the digital single market, but also for the defence and security of the EU. The latter is called upon to effectively protect its people by foreseeing potential cyber incidents, by building strong protection of its infrastructures and by rapidly recovering from cyberattacks.

## 6. Bibliography

- Bendiek A., Bossong R. & Schulze M. (2017). *The EU's Revised Cybersecurity Strategy*. SWP Comments.
- Craigen, D., Diakun-Thibault, N., & Purse, R. (2014). Defining Cybersecurity. *Technology Innovation Management Review*, 2014, October.
- Dunn Cavelty M. (2018). Europe's cyber-power. *European Politics and Society*, 19 (3): 304-320
- ENISA (2014). *Report on Cyber Crisis Cooperation and Management*. Athens: ENISA.
- ENISA (2017a). *National Cybersecurity Strategy of Greece*. Athens: ENISA.
- ENISA (2017b). *Overview of cybersecurity and related terminology*. Athens: ENISA September 2017.
- European Commission (2017a). *Joint Communication to the European Parliament and the Council Resilience, Deterrence and Defence: Building strong cybersecurity for the EU*. Brussels: September 2017.
- European Commission (2017b). *President Jean- Claude Juncker's state of the Union Address 2017*. Brussels: 13 September 2017.



- European Commission (2017c). *Regulation of the European Parliament and of the council on ENISA, the “EU Cybersecurity Agency”, and repealing Regulation (EU) 526/2013, and on Information and Communication Technology cybersecurity certification (“Cybersecurity Act”)*. Brussels: 2017.
- European Commission (2017d). *Special Eurobarometer 464a. Report. Europeans' attitudes towards cyber security*. Brussels, September 2017
- European Commission (2018). *State of Union 2018: Building strong cybersecurity in Europe*, Brussels: September 2018.
- European Council (2013). The European Economic and Social Committee and the Committee of the Regions, *Cybersecurity Strategy of the European Union: An Open, Safe and Secure Cyberspace*, Brussels: 7 February 2013 (‘EUCSS’)
- European Council (2016). *EU-NATO joint declaration*. International Summit.
- European External Action Service (EEAS) (2016). *European Union Global Strategy, Shared Vision, Common Action: A Stronger Europe: A Global Strategy for the European Union’s Foreign And Security Policy*. Brussels: EEAS.
- European Union External Action (2018). *EU-NATO cooperation – Factsheet*. Brussels: June 2018.
- European Union (2013). Directive 2013/40/EU of the European Parliament and of the Council of 12 August 2013 on attacks against information systems and replacing Council Framework Decision 2005/222/JHA. *Official Journal of the European Union*, August 2013.
- EEAS (2016). *EU and NATO Increase Information Sharing on Cyber Incidents*, European External Action Service. Brussels: 10 February 2016.
- Rehrl J. (2019). *Handbook on Cybersecurity: the Common Security and Defence Policy of the European Union*. Vienna: Federal Ministry Republic of Austria.
- Helmbrecht, U., Purser, S., & Ritter Klejn, M. (2012). *Cybersecurity: Future Challenges and Opportunities*. ENISA.
- International Business Publications (2013). *EU Cybersecurity Strategy and Programs Handbook, Strategic Information and Regulations*. Washington DC, 2013.
- Lété B. & Pernik P. (2017). *EU–NATO Cybersecurity and Defense Cooperation: From Common Threats to Common Solutions*. The German Marshall Fund of the United States.
- Luijff, E., Besseling, K., & De Graaf, P. (2013). “Nineteen National Cybersecurity Strategies“. *International Journal of Critical Infrastructure protection*, 2013, January.
- Mercado Kierkegaard S. (2008). *EU Tackles Cybercrime, Cyber Warfare and Cyber Terrorism*. Hershey Information Science Reference.
- NATO (2018). *NATO – EU Relations*. February 2018.
- Negreiro M. & Belluomini A. (2019). *The new European cybersecurity competence centre and network*. European Parliament. April 2019.
- Pernik, P. (2014). *Improving Cybersecurity: NATO and the EU*. International Centre for Defence Studies. September 2014.
- Pupillo, L., Griffith, M., Blockmans, S., & Renda, A. (2018). *Strengthening the EU’s Cyber-Defence Capabilities*. Centre for European Policy Studies (CEPS), College of Europe. November 2018.
- Saleem, M., & Hassan, J. (2019). *Cyber warfare, the truth in a real case*. Sweden: Information Security Course Linköping Universitetet.
- Sliwinski K. F. (2014). Moving beyond the European Union's Weakness as a Cyber-Security Agent. *Contemporary Security Policy*, 35 (3): 468-486.
- Tikk, E., Kaska, K. & Vihul, L. (2010). *International Cyber Incidents: Legal Considerations*. Cooperative Cyber-Defence Centre of Excellence (CCDCOE).

**TOPIC 3: EU INTEGRATION, POLITICS AND GOVERNANCE ISSUES**

### 3.1. Regional Integration in the EU; The Community Method and the Open Method of Coordination

*Ilektra Simitsi<sup>1</sup>*

#### **Abstract**

Regional integration is a method that regional organizations seek to achieve and deepen. Though, integration is not an easy process and is gradually fulfilled. Initially the “regional organization” is defined, as an organization structure, in a geographical setting, functioning under specific rules, through the directions of regional institutions, and the important and necessary participation of members and stakeholders. The regional organization highlights the establishment of a common ground for all those involved contributors. But how is integration and convergence achieved?

It is true that standing alone in a globalized world hinders the achievement of state objectives. Collectivity and cooperation on equal and horizontal terms facilitates policy making. One of the most studied and described successful examples of peripheral or regional organizations is the European Union. In the EU, different states have agreed to entrust part of their state sovereignty to a supranational organization by establishing agreements in multiple economic fields in order to support their strategic targeting and direction. This is the reason why it has been selected to define and describe regional integration through the application of hard and soft law methods.

In this current paper we will take the example of the EU to examine the results on integration by comparing the Community Method with the Open Method of Coordination. A Hard Law process compared to a Soft Law policy making process. The paper deals with the benefits and hurdles of output legitimacy vs process legitimacy and their effectiveness on regional integration. These Methods have been selected since there is a dispute over whether they ultimately affect or serve the interests of their members by actually promoting European integration, participation and cooperation or if they ultimately hinder the integration process.

**Keywords:** Regional Integration, Open Method of Coordination, Community Method, Soft Law, Hard Law

#### **Introduction**

As of the introduction, it is useful to make a reference in the different types of integration. This will assist to understand the evolution that regional organizations are following, taking into consideration the operation of the European Union (EU). It is also to be noted that regional organizations are suitable for the development of multinational agreements, since they represent number of states with diverse perspectives. Therefore, a group of states with mutual interests may succeed in promoting international standards and agreements through cooperation (Cooper et al. 2008).

The relationship between members of a regional organization and the degree of regional integration takes place over three generations. The first relates to economic integration, which mainly involves free trade agreements and is characterized by negative integration (abolition of restrictions) as it relates only to commercial type agreements. The second generation concerns the political sphere, including rules, institutions and security. Both of them relate to the internal affairs of the organization. In the specific case of the EU, political

---

<sup>1</sup> PhD in Law Dept. of Law, University of Democritus, Komotini, University of Democritus, Greece, MSc in European Law, University of Democritus, MSc in Public Policy and Human Development, Maastricht University – UNU Merit, Email: ilektrasimitsi@gmail.com

cooperation (second generation) and 'positive integration' have resulted - for example through the dissemination of responsibilities - of previous negative integration (first generation), which has failed to achieve a functioning common market. To act as a player on the international stage, and therefore outside your own territory, implies a willingness and ability to address regional governance challenges outside the region. Regional organizations then develop a strong sense of identity (coherence) and take on an increasingly confident external image in interaction with third countries, other regions and within multilateral institutions. The EU is a deeply institutionalized and politicized union, which has demonstrated its ability to varying degrees in the range of domestic policies (first and second generation). In this process of enlargement and deepening of policies, structures and members, the EU has become a global player in international fora where only states (third generation) once functioned (Langenhove & Costea, 2007; Langenhove & Marchesi, 2008).

### **Regional Governance**

The EU, as a regional organization, has developed mechanisms to facilitate its operation, reduce the gap and differences between its members and move jointly towards regional integration, first and second generation, and with the Treaty of Lisbon moves to the third generation of the regional integration phase. In view of the above, in the context of integration, two methods have been selected, the Community Method promoting integration through the rules of law in the context of second-generation integration and the Open Method of Coordination, as a method to promote the transition to third generation integration where the Union will act as a single entity with an international identity.

Governance encompasses a set of decisions and processes designed to reflect social expectations through the administration or leadership of government (Fasensfest, 2010). The European Commission's definition of governance is that '*governance means rules, procedures and behaviour that influence the way in which powers are exercised at European level, in particular transparency, participation, accountability, efficiency and cohesion*' (European Commission, 2001). The EU is an example of a regional organization with intergovernmental characteristics, while providing supranational elements while giving governments greater autonomy and promoting regional integration.

For the European Union, therefore, we are referring to a form of supranational 'governance' rather than 'government' as though institutions and structures have been developed which may be reminiscent of state-owned, but have powers equivalent to those of a government in areas conferred by Member States (Thomas, 2009). They refer more to top-down decision-making approach while including both formal and informal, non-governmental institutions that operate and function in the public sphere. Moreover, the diversity of the Union and the dispositions of the Member States justify the fact that the Union co-exists in various forms of transnational and intergovernmental governance, especially in the areas of exclusive competence.

The European Union represents an interesting case of 'governance' because it has institutions entrusted with specific responsibilities; central and sovereign bodies can enforce policy hierarchically, from the central administration to the state structure of the EU territory. In the EU, institutions have been established whose

decisions are regulated by a judicial body, which is usually found in a state and not a regional formation. But these institutions function differently from the state. The Council, for example, is made up of representatives of the governments of EU members. Therefore, the EU does not govern exactly like the state since for example it cannot legislate for education but can through the Regulations in the policy areas that are within the scope of the powers conferred by the Member States themselves, to legislate, depending on them in the implementation. It is almost unreasonable to refer to European governance as such, as it is not a state, but it has the capacity to make binding decisions that ultimately affect the citizens.

In short, the EU presents an interesting and unusual form of partnership (Tsatsos, 2007). Of course, the Union is not a state, but it is more than just an international organization. Indeed, the horizontal and cooperative nature of the EU, divided as it is between the transnational, intergovernmental and transitional levels, indicates that EU political administration is most effectively implemented through multi-level governance (Kohler-Koch & Eising, 1999), with European supranational institutions having a dominant role<sup>2</sup>.

### **The role of binding and soft rules**

As mentioned in the sections above, the Union is an organization which evolves in response to the needs of its constituent members. Like the Union, so do the developed regional organizations, and in particular those with higher integration rates, establish rules and set strategic goals to ensure their future existence and evolution to pursue their interests both domestically and internationally<sup>3</sup>. These rules governing the functioning of regional organizations vary depending on the degree of integration of members, mainly due to the weight of the circumstances and the intrusion into multi-level governance of decisions taken from the top down. The existence of operating rules and the maintenance of relationships are an important factor in the operation and organization of a regional organization, especially in times of crisis or discord.

One of the most common distinctions of international regulations is that of binding or non-binding force for which extensive literature has been developed. In short, the discussion focuses on the term 'law' being distinguished and referred to as 'soft-law' and 'hard-law'<sup>4</sup> with the analysis focusing on the term 'law' and individual its distinctions (European Parliament, 2007). Supporters of positive law, by referring to "the law,"

---

<sup>2</sup> For the EU institutional system especially after the Treaty of Lisbon, see indicatively: Calabros G.-E. F., Georgopoulos G. (2010), *European Union Law*, Volume I, Institutional Law, Law Library, Athens, p. 119 onwards; Kanellopoulos Pan (2018), *European Union Law (Lisbon Treaty)*, 5th Edition, ed. Sakkoula, Athens - Thessaloniki, p. 125 onwards; Pliakos Ast (2012), *European Union Law*, 2nd Edition, Law Library, Athens, p. 224; Chrysomallis M. (2010), *European Union Law, the Lisbon Treaty*, V. Katsarou Editions, Athens, p. 49 onwards; Craig P., De Búrca Gr. (2015), *EU Law, Text, Cases and Materials*, 6th Edition, OUP, Oxford, p. 30 onwards; Barnard C., Steve Peers St. (2016), *European Union Law*, OUP, Oxford, p. 37 et seq. Schütze R., *European Constitutional Law*, Cambridge University Press, Cambridge, p. 116 onwards.

<sup>3</sup> For more information regarding the integration indicators, see indicatively: Lombaerde P., Langenhove L. (2015), *Indicators of Regional Integration: Conceptual and Methodological Issues*, UNU-CRIS Occasional Papers, 0-2004/15, p. 4-34, available at: <http://cris.unu.edu/sites/cris.unu.edu/files/O-2004-15.pdf>

<sup>4</sup> For more information, see indicatively: Johnston, D. M., Shelton, D. (2001), *Commitment and Compliance: The Role of Non-Binding Norms in the International Legal System*, AJIL, 95(3), p. 709; Reincke H. W., Witte J. M. (2003), *Challenges to the International Legal System Interdependence, Globalization, and Sovereignty: The Role of Non-binding International Legal Accords*, Commitment and Compliance, p. 75-114

define binding rules. Rationalists argue that reference to law is simply the importance of the requirements and therefore non-compliance may and may not lead to sanctions. Still, the constructivists argue that this condition of law only matters as a result at the implementation stage. For example, in international law, where there are no institutions, researchers argue that the general rules are soft or elastic in form and force compared to the requirements of domestic law.

In order to understand this distinction, by generalizing the definition, we consider that all rules are of some kind agreements which are distinguished by particular characteristics. The legitimacy of binding rules at the level of international relations is defined in three dimensions, namely precision, obligation and representativeness<sup>5</sup>. Binding power refers to obligations that are accurate, are delegated to an authority for their interpretation and implemented accordingly, producing the corresponding results for the actors. On this basis, soft power falls short of binding since the "action" of these rules begins when binding rules are for some reason weakened in one of the three dimensions mentioned above. Accordingly, if there is agreement on such binding force it is that if it leaves room for ambiguity in application, it is considered to be soft-elastic. In addition, if there is no authority to check or evaluate the results then it can still be considered soft.

Standard and binding rule-based enforcement relates to cases where the rules are subject to judicial review or in a very restrictive form of non-judicial review. Soft enforcement concerns procedures designed to ensure compliance without necessarily resorting to the judiciary. This is the case for most international treaties, where parties are not required to address the International Court of Justice.

### **The Community Method and the Open Method of Coordination**

The Community Method, promotes integration through the rule of law in the field of exclusive competence of the Union and in accordance with the principle arose from the Treaties. The Community Method is binding. The binding validity of the rules, as is characterized by the word itself, applied mainly through rules, it obliges the Member States to follow any agreement while any possible breach has significant legal implications. The institutions responsible for the production and control of binding rules are more credible because their decisions have direct legal implications for the national legal order. When a Treaty is implemented through harmonization with national law, it motivates local actors by increasing their obligations and at the same time their credibility. These institutions create complementary mechanisms in binding rules if they demonstrate to be incomplete, allowing States to further control and strengthen their obligations through recourse to judicial bodies. However, binding rules are usually difficult to change or adapt to circumstances in particular when uniformity, tolerance of ethnic diversity is required, and when adaptation to change is necessary.

On the contrary, as is explained below, non-binding rules are more flexible. They are easier to negotiate, have a lower impact on national sovereignty, provide greater flexibility in the states to which they apply as these it

---

<sup>5</sup> See indicatively: Steffek J. (2015) *The output legitimacy of international organizations and the global public interest*. *International Theory*, 7(2), p. 263-293, available at: <https://doi.org/10.1017/s1752971915000044>

seems to be freer to cope with a state of uncertainty enhancing knowledge within, usually, a longer period of time. Soft rules and processes, here expressed through the OMC, also allows states to be more ambitious and actively participate in deepening collaborations, better address diversity and institutions are readily available to non-state actors such as administrative services, NGOS, public administrative bodies, or associations. Just because soft power is more flexible, states uses “soft” law when contracting powers are increased, either because of the number of parties involved, either because of uncertainty of results or the degree of achievement of targets, domestic challenges, politically charged issues or distribution interactions<sup>6</sup>.

### The Community Method

This process is entrusting state sovereign powers to the Union where the ECJ is responsible for overseeing the rules and compliance of members whose participation contributes to legal integration through a majority and anthropocentric process. The nature of the Community legal order is attempted through the 'Community method' (Stephanou, 2001) a method that is observed to be innovative as it combines these features at the same time. Of course, the Member States of the EU have in policy areas refused to confer their powers, and thus the Community method is not applied, leading to the coexistence of national and supranational powers. However, the Union's supremacy in the areas of conferred competence has not been disputed because of its effectiveness and has been established by the legitimacy of the outcome (Weiler, 2013) through the controlling powers of the European Court of Justice.

In order to ensure that the Community method is effective and operates in the common interest, the Member States of the Union have decided to delegate part of their powers to the Union through the Treaties<sup>7</sup>, under the conferral<sup>8</sup>. The Community method was built using the institutional path – European Commission, and the legal dimension, through the Treaties, law and the ECJ.

Key features of the Community methodological process at institutional level are, first, that the Commission has the legislative initiative<sup>9</sup>, gradually shaping the degree and pace of European integration. This independence has been granted to it by the Treaties as it can initiate a procedure but also terminate it by withdrawing it, and the Council can amend the decision only after unanimity<sup>10</sup>. The second institutional feature of the method is that all the crucial decisions of the Union are taken through the ordinary legislative procedure and with the approval of the EP as the representative of the citizens and the Council, as the representative of the Member States, in accordance with the 'principle of dual legitimacy of the Union's power' (Tsatsos, 2007: 157). The principle of dual legitimacy proclaims representative democracy as the organizational basis for the functioning of the Union and reflects its dual legitimacy as a Union of States and Citizens and its corresponding

---

<sup>6</sup> See indicatively: Abbott K., Snidal D. (2000). *Hard and Soft Law in International Governance*, International Organization, 54(3), p. 421-456, available at: <http://www.jstor.org/stable/2601340>

<sup>7</sup> Articles 2 - 6 TFEU

<sup>8</sup> Article 5 TFEU

<sup>9</sup> Article 17 §. 2 TEU

<sup>10</sup> Article 293 TFEU

dual representative base: States and citizens. In the context of the democratic deficit faced by the union, this principle confirms the cooperation of the Council representing governments and of Parliament as a representative of citizens as a fundamental democratic principle<sup>11</sup>.

However, decisions taken at European level by the Commission are implemented and enforced through national governments for reasons of speed and flexibility, i.e. Member States have executive power<sup>12</sup>. Article 19 TEU states that 'the Court of Justice of the Union shall ensure the observance of the law in the interpretation and application of the Treaties'<sup>13</sup>. In accordance with the competences deriving from the Treaties, the ECJ ensures and guarantees the interpretation of European law so that it is effective in its application to the jurisdictional systems of the Member States, guarantees and supervises the compliance of the institutions, Member States and citizens in the EU process as well as ensuring respect for the rule of law. A key component of the functioning of judicial control is that it complements weaknesses in the control of the institutions at Union level. Article 13 (2) TEU preserves the balance between the institutions for further enhancing efficiency and democracy by stating that 'each institution shall act within the limits of the powers conferred on it by the Treaties, in accordance with the procedures, conditions and the purposes for which they are provided. The institutions cooperate with each other in good faith'<sup>14</sup>.

The above comes from the principle of institutional equilibrium. In the context of institutional symmetry, with regard to participation in the consultation that 'it is the instrument enabling Parliament to participate effectively in the Community legislative process'. This competence is an essential element of the institutional balance sought by the Treaty (combating the deficit of democracy). It is a reflection, albeit limited, at Community level, of a fundamental democratic principle whereby peoples participate in the exercise of power through a representative assembly. Therefore, proper consultation of Parliament in the cases provided for by the Treaty constitutes an essential wording, failure to comply with it would invalidate the measure in question. Each institution shall act in accordance with the tasks conferred upon it by the Treaties, in accordance with the division of powers. This principle stems from a 1958 Court of Justice ruling and prohibits the usurpation of one institution's powers by another institution. The Court of Justice of the European Union is responsible for ensuring that this principle is respected. Simply put, this concerns the relationship between the 3 main EU institutions: the European Parliament, the EU Council and the European Commission. Relations between these bodies have greatly evolved over the years since the adoption of new Treaties. The powers of the European Parliament, in particular, have been broadened, recognizing the right of co-decision with the Council (in the ordinary legislative procedure) for most EU policy areas, as well as wider budgetary powers (Jacqué, 2004).

---

<sup>11</sup> Article 10 TEU

<sup>12</sup> Articles 290 and 291 TFEU

<sup>13</sup> Article 19 TEU

<sup>14</sup> For the principle of institutional balance, see indicatively, Jacqué J. P. (2004). *The principle of institutional balance*, CML Rev, p. 383-391. Majone G. (2005). *Institutional Balance Versus Institutional Innovation*, Dilemmas of European Integration, p. 83-106, available at: <https://doi.org/10.1093/0199274304.003.0005>



The Community method is applied through the Union institutions, but it also develops a legal dimension which is ultimately interdependent and inseparable from the method, explaining why it is also called legal integration. An essential and distinctive feature of the European Union and of the integration process is the law, the rules of law developed and applied through harmonization in each Member State of the Union. European law is in force and is being developed in the Union as Member States have agreed to grant state donors to it, recommending the EU as an autonomous legal entity. EU law has immediate effect<sup>15</sup> for the Member States of the Union, namely the ability of the Union rule to produce rights which both natural and legal persons can claim directly before national courts, but also prevail over national courts and national law and the direct effect principle<sup>16</sup>.

The direct effect principle allows individuals to rely directly on a European rule before a national or European court. This principle applies only to certain European acts. On the other hand, it is subject to many conditions. The direct effect of European law is, along with the principle of excellence, a fundamental principle of European law. It was established by the European Court of Justice (ECJ). Allows individuals to rely directly on European law before the courts, regardless of the existence of texts in national law (Papadimitriou, 2008).

The direct effect of European law was established by the Court in Van Gend en Loos, judgment of 5 February 1963, placing it at the highest level of European legal order concerning primary law. In this judgment, the Court states that European law does not only create obligations in EU countries, but also rights for individuals. Thus, individuals can assert these rights and rely directly on European rules before national and European courts<sup>17</sup>. Therefore, it is not necessary for the EU country to have this European rule included in its internal legal order. The immediate effect consists of two aspects. It is defined as a vertical direct effect and applies to relations between individuals and the country. This means that individuals can rely on a European rule vis-à-vis the country. Also, the horizontal direct effect applies to relationships between individuals. This means that one individual can rely on a European rule over another<sup>18</sup>. However, it states that the implementation of immediate effects depends on the clarity of non-hereditary obligations and that there should be no need for additional measures of a national or European nature, as long as there is no national scope<sup>19</sup>, always dependent on the type of operation, Regulations - indirect effect, Instructions-transposition. However, the Court recognizes, in some cases, an immediate effect in order to protect the rights of individuals. The Court thus states in its case-law<sup>20</sup> that a directive has direct effect when its provisions are unconditional and sufficiently clear and specific and when the EU country has not transposed the directive within the time-limit<sup>21</sup>.

---

<sup>15</sup> See indicatively: ECJ, judgment of 05.02.1963, Case 26/62, Van Gend en Loos, Coll. 1963, p. 871

<sup>16</sup> See indicatively: Dagtoglou Pr. (1985), *European Community Law*, 2<sup>nd</sup> edition, Ant. Sakkoulas Athens-Komotini., p. 207 onwards' Craig P., De Búrca Gr., *EU Law, Text, Cases and Materials*, ibid, p. 184 onwards.

<sup>17</sup> See indicatively: ECJ, judgment of 05.02.1963, Case 26/62, Van Gend en Loos, Coll. 1963, p. 871.

<sup>18</sup> The direct effect of European law, Access to European Union law, Eur-Lex, 2015.

<sup>19</sup> ECJ, judgment of 19/01/1982, Case 8/81, Becker [198253 ECR], paragraph 18.

<sup>20</sup> ECJ, judgment in Case 4/121974, Case 41/74, van Duyn [1979] ECR I-00861, paragraphs 9 and 12.

<sup>21</sup> For direct effect, see indicatively: ECJ, judgment of 5/04/1979, Case 148/78, Ratti [1979] ECR I-00861, paragraphs 22, 24, 43, 45; ECJ, judgment of 19 January 01 1982, Case 8/81, Becker, 1982, p. 53, paragraphs 23 to 25; ECJ, judgment

For all European acts with binding force, European law takes precedence over the national laws of the States participating in the Union, in accordance with the principle of primacy, which guarantees that primacy. The principle of the primacy<sup>22</sup>, Just like the direct effect that protects individuals, it is not explicitly provided for or referred to in the Treaties, but established through the judgments of the Court of Justice of the European Union (WEU). The principle of primacy was established by the Court in *Costa v Enel*, judgment of 15 July 1964 (Judgment 6/64)<sup>23</sup> where it essentially stated that the law deriving from the European institutions is incorporated into the legal systems of the Member States which are obliged to respect it, namely 'where law deriving from the Treaty derives from an autonomous source of law, it is not possible, because of its peculiar original character, to be opposed to any internal legislative text'<sup>24</sup>. Member States are therefore obliged to respect and integrate the European into national law and this is why their supremacy is confirmed. Thus, in cases where there is a disagreement or even contradiction of a European provision with the national one then the Member States must apply the European one. The application of European provisions does not abolish national laws but suspends their mandatory effect. In addition, the Court has stated that European law takes precedence over and applies to the acts of the Member States, irrespective of the time of its adoption, that is to say whether it is before or after the corresponding national act. The principle of excellence thus ensures uniformity of application in the Member States and therefore of the citizens, which is ensured throughout the EU<sup>25</sup>.

In addition, direct power and superiority, in conjunction with the principle of the responsibility of the Member States to remedy the harm caused to individuals in breach of Union law<sup>26</sup>, ensure the protection of the rights deriving from Union law from individuals who are subject to the Union's legal order.

Apart from the establishment of an autonomous legal order, the Court of Justice in the case of the Greens has recognized that the community is a community of law<sup>27</sup>, making law not only an instrument but also a goal of the unification process<sup>28</sup>. The principle of the rule of law of the Union functions as a protection system since it is universal and horizontal in that it encompasses both the concept of formal and substantive rule of law with

---

of 26/02/1986, Case 152/84, *Marshall*, 1986, p. 723, paragraphs 40 to 4; ECJ, judgment of 4/12 / 1986, Case 71/85 *Vakbeweging* [1986] ECR 03855, paragraphs 13 to 15, 21; ECJ, judgment of 22/06/1989, Case 103/88, *Fratelli Costanzo / Comune di Milano*, 1989 [1989] p. 01839, paragraphs 29 to 31.

<sup>22</sup> See indicatively: Dagtoglou Pr. (1985), *European Community Law*, 2<sup>nd</sup> edition, Ant. Sakkoulas Athens-Komotini., p. 185 onwards; Craig P., De Búrca Gr., *EU Law, Text, Cases and Materials*, ibid, p. 266 onwards.

<sup>23</sup> From the rich case-law of the Court, see indicatively. inside ECJ, judgment of 7/7/1964, Case 6/64, *Fl. Costa v ENEL*, 1964, p. 1965; ECJ, judgment of 17/12/1970, Case 11/70, *Internationale Handelsgesellschaft*, 1970, p. 1125 ECJ, judgment of 9/3/1978, case 106 / 77, *Simmental (II)*, 1978, p. 629. ECJ, judgment of 19/6/1990, Case C-213/89, *Factortame*, 1990, p. I-2433

<sup>24</sup> Case 6/64 *Costa v ENEL* [1964] ECLI:EU:C:1964:66 para.593

<sup>25</sup> The supremacy of European law, Eur-Lex, 114548, available at: <https://eur-lex.europa.eu/legal-content/EL/TXT/?uri=LEGISSUM%3A114548>

<sup>26</sup> ECJ, judgment of 19/11/1991, Case C-6 & 9/90, *Francovich and Bonifaci*, [1991] p. I-5357

<sup>27</sup> ECJ, judgment of 23/4/1983, case 294/83, *Eco-Party of the Greens*, 1986, p. 1339

<sup>28</sup> As noted in Article 2 TEU

the principle of legality and effective judicial protection and respect for fundamental rights (Crabit & Bel, 2016).

In the context of the organization of an internationally organized and globalized society, the European Union through the Community method is the most effective example of an international organization operating and evolving through its law and rules and its integration and compliance at national level member. This conclusion is reinforced by the majority decision-making process, the Member States' commitments deriving from legal commitments, in conjunction with the Court's function of safeguarding control.

In addition, when compared to intergovernmentalism, the Community method evolves the process of European integration in the presence of strong democratic elements not found in other regional organizations, since (1) democracy is ensured by the involvement of the institutions in the decision-making process as previously mentioned (2) the principle of dual legitimization of European and state, states and citizens in the process of respecting the rules is enshrined and applied<sup>29</sup>. In all cases, transparency, control and accountability must be constantly ensured<sup>30</sup> to the Union institutions for the protection of fundamental rights and beyond. Subsequently, this legal dimension which gives the union the rule of law guarantees and allows the union some flexibility, especially following the continued accession of Member States in the past<sup>31</sup>, but even respond to ongoing developments, such as with the United Kingdom, by preventing Member States from departing from the rule of law and the Community method in particular in cases where for some reason they are expediting cooperation in specific areas, seeking their national interests.

Therefore, we can safely note that the Community method is a tool of governance which is highly effective in the functioning of the European Union but also ensures its cooperation with the Member States.

### **The Open Method of Coordination**

In addition to the Community method, new, parallel forms of governance were sought that would influence and shape policy-making, the effectiveness of Member States' actions and the formulation of strategy, always in the light of regional integration, including Member States, and integrating other actors into this process, shaping the areas of competence not delegated by the Member States of the Union. This dynamic of methods was developed as convergence could not be an exclusivity of integration solely through the use of binding rules but had to be expanded into policy areas where Member States operated independently, drawing up their own national policy, where no grant of sovereign powers to the EU is applied.

The Open Method of Coordination (OMC) has been one of the tools to promote integration in areas where the Union has no exclusive competence. Its analysis is based on the fact that it is a method that promotes the

---

<sup>29</sup> Articles 9-12 TEU

<sup>30</sup> For more information on accountability, see indicatively: Keman, H. (1997). The Politics of Problem-Solving: Democratic Responsiveness and Political Accountability. *The Politics of Problem-Solving in Postwar Democracies*, p. 162-187, available at: [https://doi.org/10.1007/978-1-349-25223-7\\_8](https://doi.org/10.1007/978-1-349-25223-7_8)

<sup>31</sup> Articles 20 TEU and 326 TFEU.

process of European integration, while complementing and complementing the Community as a process of producing EU law, in areas where the Union cannot impose rules on State members.

The Open Method of Coordination is a method that is not based on legal commitments or, of course, on sanctions (Borrás & Radaelli, 2010). Stressing the OMC's building blocks, Jonathan Zeitlin describes it as 'an experimental approach to European Union governance, based on the repeated benchmarking of Member States' progress towards common European goals and organized mutual learning' (Zeitlin, 2012). The OMC is an intergovernmental policy practice that is not a consequence of EU law and does not create obligations that Member States are not bound by the formulation or modification of their legislative framework, as is the case with the Community method (Radaelli, 2003).

The OMC is a process of shaping EU policy in the EU, and recommends a mechanism of guidelines. It formally entered into force at the Lisbon European Council in 2000 and evolved in 2009, signalling the changes introduced by the Treaty. The main characteristic of the OMC is that its results do not evolve into legislative acts, but remain as a soft form of governance aimed at disseminating good practice and seeking to bring convergence of objectives set at European level into certain areas in which Member States, they find it difficult to follow.

The OMC was formally introduced in order to complement but also address the challenges and weaknesses of the Union, seeking to correct the weaknesses of the Community method in integration policy and in particular the process of harmonization with regard to subsidiarity and the conferral of specific powers on the part of member-states of the Union:

- setting guidelines for the Union, combined with specific timetables for the short-, medium- and long-term achievement of the objectives they set, in the context of a specific rational intervention of the action;
- setting, where appropriate, quantitative and qualitative indicators and benchmarks, tailored to the best of the world, tailored to the needs of different Member States and sectors, as a means of comparing best practices, and measuring the impact and results of its use,
- transpose European guidelines into national and regional policies by setting specific objectives and adopting measures, taking into account national and regional specificities, but without committing but urging them;
- periodic monitoring, evaluation and review, in the form of interdisciplinary processes, to support both the association and its members in an evolutionary process and to propose new complementary or corrective actions.

It can be described as a multilevel governance process, initially introduced by the European Council which agrees with the general objectives and priorities, then the Council of Ministers selects the quantitative and qualitative indicators to be used in the evaluation of national practices, which however, indicators are selected

on a proposal from the Commission or from States and / or relevant bodies. Following is the adoption of the measures at national and regional level, taking into account the differences between the Union and the Member States with a view to achieving the objectives set out under these indicators. These are the so-called National Action Plans. This process is completed after evaluation and peer review by Member States. The role of the European Parliament in this process is considered to be very limited and is primarily defined in the form of advice, as is the role of the Commission where it is limited to simple monitoring and supervision.

For many authors 'policy learning' and 'benchmarking' are some of the key features or even the reason for the European process. In this light, it seems even more striking that OMC inquiries often remain rather vague as to what they actually refer to when making claims about the success or failure of "benchmarking" in this context. The Member States and the European Commission are involved in what is called "collective benchmarking". This is accomplished through the following steps (Vanhercke, 2016: 171):

- Framework agreement (mandate) - common objectives.
- Selection of key issues in a policy area.
- Creating a knowledge base where defining issues and developing common benchmarks for quantitative benchmarking.
- Support the process through networks of experts (non-governmental organizations) and EU (civil society) stakeholders.
- Participate in the benchmarking process.
- Drafting conclusions: Joint reports on social protection and social inclusion and Commission 'recommendations' (lessons learned).

The starting point for benchmarking in the OMC is the acceptance by Member States of a set of "common objectives". These provide the command, and thus determine the implementation framework. The objectives set out in this area are to list the desired, future, results that the use of the OMC will bring, as well as how they will be developed and formulated politically in the light of good governance. Because the common goals are intended to be fairly stable over time and to be unanimously agreed by governments from all member states across the political spectrum, they are of a general nature. This generalization has received negative criticism but it has been pointed out that it is precisely because of the 'general' or 'unclear' nature of the objectives that it may constitute the initial stage of European 'exercise of consensus', leading to a deepening of positive integration<sup>32</sup>. An important added value of the objectives is that they structure the policy area in a way that

---

<sup>32</sup> See indicatively, Reyniers Ph., Van Gehuchten P-P, Vanhercke B. (2011), *Le potentiel de la législation européenne sur la sécurité sociale et la lutte contre la pauvreté*, στο Vanhercke B., Verschraegen G., Van Gehuchten P-P., Vanderborgh Y. (eds.) (2010), *L'Europe en Belgique, la Belgique dans l'Europe, Configuration et appropriation des politiques sociales*, Academia Press, série: Société et Avenir, Gent, p. 107–110, available at: <http://www.belspo.be/belspo/ta/publ/academia%20europa%20in%20belgie%20U1613.pdf>.

promotes a balanced political approach on the various sides and is widely accepted by both EU and internal policies.

Unlike the Community method where its application is vertical and specific, the OMC does not apply the same in the policy areas. Although the Method is the same, the implementation method is changed and configured to achieve the best possible result in the application area. Thus, some require the intervention to be controlled through the use of indicators while others do not, others require external evaluation while others do not. Due to the different process of OMC implementation it is sometimes characterized as weak or moderate in power or even strong which tends to become more binding. The characteristics on which this separation is based depend on the existence of defined common guidelines, the penalties for failure to meet the set criteria and the degree of involvement of other actors beyond state-government, such as the social partners and the role played by them, are called upon to play a role in the implementation of the method (Hatzopoulos, 2007) applications that are not so frequently encountered, as the OMC type of binding does not bring real sanctions.

In addition to separating the strong and weak OMCs, it is proposed to separate the small and large types of Open Methods, which results from the degree of interconnection with the Lisbon Strategy or the E2020. When referring to the achievement of the macroeconomic policy objectives of the Member States and the employment policies directly linked to the strategic objectives of the Union, we are referring to the larger type of OMC, where the European Council is involved, focusing on achieving common goals and focusing on national objectives while for the small OMC the relationship with Lisbon and the E2020 is simply not so clear, giving more weight to the exchange of good practices and not so much to the accentuation of national policies (Borrás & Radaelli, 2010: 49). The structural characteristics of the OMC can be classified and explained below:

#### 1. Coordination of national competences

It is a fact that Member States, as integral parts of the Union and as promoters of the integration process, aim and act in a common direction. In areas where there is no concession and therefore Union action, coordination mechanisms are used. In this case - the powers not conferred - no powers have been conferred on the Union by the Treaties nor harmonization measures are foreseen.

#### 2. Legally non-binding rules

As a method of coordination, its acts have no binding force on the Member States and do not lead to legally binding rules subject to judicial review. It therefore implies that the OMC is an intergovernmental process rather than a governmental one. Referring to the binding or not of the rules, the OMC certainly falls within the non-binding framework, even limiting its designation as soft law since no legal regulation is followed. The term soft law, however, is not completely ruled out, as there are procedures for the adoption of Recommendations adopted by the Council on the basis of national reform plans.

#### 3. Compliance of Member States

Due to the lack of judicial control, the actions resulting from the implementation of the OMC and their implementation are based on the spirit of cooperation of the actors involved in it, pursuing the common goals that they have set themselves. The only motivation, and quite important, for convergence and achievement of goals is the fear of participants being judged negatively if they do not have the desired results and if the aims and results of the interventions are not desirable, or cannot reach the goals or generally there is a failure to achieve performance. For example, the Ministry of Labour at each beginning of its programming period draws up the Action Plan for the chosen field such as the Youth Vocational Education and Training Action Plan (for many years now). In its drafting process, in employment, education and labour policy, areas where members have not been given state powers, they are asked to describe the actions they will take to reduce, for example, youth unemployment rates. In this context they anticipate and erase the logic of intervention by setting actions, outputs and outputs indicators, milestones and performance indicators. The Action Plan is submitted to the Commission for evaluation. If actions do not produce the desired results, the Member State is 'stigmatized' as being unable to achieve the objectives set.

#### 4. Wide involvement

The implementation of the OMC is a participatory process in governance as it involves all intergovernmental bodies, state, regional and local authorities, administrative bodies, legal entities, agencies, NGOs, research centres and research institutes, partnerships that, through their collaboration, promote a common goal, aim in one direction by improving existing structures. Targets are initially set by the Member States, and Working Groups are set up in each coordination area. Whereas the actions to be implemented are more dependent and shaped within the state. It is generally accepted that stakeholders and Member States participate in the process in good faith and ultimately the degree of involvement and responsibility is dramatically reduced. One possible solution is for state and technical structures to take more action by strengthening national governments, but raising problems of transparency since they will not ultimately fall under the Union's control mechanisms, the European Parliament and the Court of Justice.

#### 5. Flexibility of implementation

Just because the OMC fields of application and the bodies implementing it differ, the method itself is flexible as it can be adapted to the needs of each policy area. But precisely because of this flexibility and the unclear rules that govern it, it loses its effectiveness by rekindling criticism of the effectiveness of its use in resolving and tackling more serious and permanent problems (Borrás & Radaelli, 2010: 51).

### **OMC and intergovernmentalism**

The responsibility for using the OMC lies with the Member States and their national governments, thereby confirming its intergovernmental character, while reinforcing the role of the Council or the European Council which are required to specify common objectives (Hatzopoulos, 2007). In this process, the Commission's role in drawing up new legislation while protecting the interests and procedures of the Union and its members is

neglected. Accordingly, the European Court of Justice and the Court of Justice are not involved in this process at all, which is partly justified for the Court since the OMC results have no legal commitments and do not produce legal effects. However, the European Union would probably need to be involved as it is the Union's monitoring body and further legitimizes EU-wide actions (De Búrca, 2003). Evaluating the structural features of the OMC, a legitimate concern has been raised by the European Parliament, on the one hand, on its democratic legitimacy, and on the other, on the undermining of the Community method. As an EU body directly elected by EU citizens, the European Union has called for more involvement in the OMC in order to become more democratic. The 2003 resolution on the implementation of the open method of coordination<sup>33</sup> called for the introduction of the OMC in even more areas, but warned that the open method of coordination should not be an opaque and subversive parallel process in the EU. The 2007 resolution on the use of soft law goes even further and calls the OMC 'Legally doubtful' because of insufficient parliamentary and judicial involvement and warns that its use may replace Community law when the Treaties do not allow it<sup>34</sup>.

## Conclusions

Apart from the effectiveness or general acceptance or non-acceptance of the Method, one of the major problems arose is that its application may harm the functioning of the European Union and European institutions, as it is legitimized by the procedure (Follesdal & Hix, 2006; McKormick, 2011) and because it distorts the application of the Community method, exacerbating the lack of democratic legitimacy and undermining the legitimacy of the outcome. The fact that, on the one hand, the European Parliament and the Court of Justice are not involved in the process of breaking the Union's institutional balance, and on the other, problems of overriding Community competences are encountered.

Particularly evident is the diffusion of the Commission's powers as it controls the cooperation of Member States in the implementation of the agreed actions, as a further intergovernmental cooperation. The OMC raises serious questions about the legitimacy of the responsibilities of the institutions, without being provided for in the Treaties, or without being confirmed by the Court's case-law. In addition, the absence of judicial review and non-legislative decision-making by the institutions<sup>35</sup> slows down the integration process.

In the same context was the statement by European Commissioner Michel Barnier who noted that «*Citizens are protected by the rules of law which form the basis of the European social model by offering effective guarantees compared to any other alternative to a soft rule. If citizens are deprived of genuine judicial guarantees then soft law procedures protect the powerful by preventing the functioning of democracy and the rule of law*» (Barnier, 2001). On the contrary, in the process of the Community method, the institutions

---

<sup>33</sup> Official Journal C 68 of the 18/03/2004 p.605.

<sup>34</sup> Official Journal C 187 of the 24/07/2008 p. 76.

<sup>35</sup> An example of misuse of soft law rules is the Stability and Growth Pact where no sanctions were imposed in Germany and France on the Excessive Deficit Procedure.



participate and decide collectively on the basis of the ordinary legislative procedure while maintaining the Union's institutionality (McKormick, 2011).

It is clear that OMC-type governance has (substantial) implications for the EU's institutional balance, but seems generally acceptable, even desirable. While intergovernmental institutions are in an even more privileged position than in other forms of governance, the European Commission, a supranational institution, also plays an important role in the OMC process. This role is *prima facie* (and perhaps even minor) weaker than its traditional character, but the Commission has managed to find and secure a decisive function. It is certainly stated that due to the non-binding nature of its acts, the OMC inevitably lacks a legal commitment, contrary to the Community method and therefore lacks compliance mechanisms as it is based more on the ease, willingness and degree of involvement of members. It appears weak in terms of commitment and compliance but possible in the creation of new actions and links between Member States and their bodies within the Union, promoting a cooperative learning environment and group action, which may lead to the institutional agenda of the Community method, which of course has not been confirmed.

The coexistence of the OMC with the Community method and its relation to European constitution which ultimately accompany European integration leads to the conclusion that the scope of the Community method was widened even after the emergence of the OMC<sup>36</sup>. The areas of application of the OMC and of the Community method differ, since the former does not aim at replacing the latter, but confirms a parallel process of delimiting common EU policies. The OMC has not been subject to the Union's exclusive competences, but its use allows for action in specific areas. This is also confirmed by the Commission's 2001 White Paper stating that the OMC "should not be used where Community-wide legislative action is possible" and rejected its use in the fields of migration and asylum, and that elements of the OMC such as national action plans, evaluation meet and the involvement of many stakeholders, and in Guidelines<sup>37</sup>.

Ongoing controversy lies between the effectiveness or the usefulness of rules with binding force as opposed to soft-law procedures with regard to the promotion of the EU integration process. Although it has been agreed that the OMC is the tool for promoting action in policy areas where Member States retain their sovereignty, it may eventually slow down the integration process as there is no explicit reference to the Treaties, and the principle of direct effect does not apply.

Member States do not seem to want to confer more State powers, an area in which the OMC is quite useful, even if it raises issues related to the lack of direct effect. In addition, as regards governance cooperation, the Treaties have provided for it, as they look to enhanced cooperation between Member States, ensuring the integrity of the Union legal order where the OMC is not sufficient. In general, expectations are low for the

---

<sup>36</sup> A prime example is the integration of Police and Judicial Cooperation in Criminal Matters with Lisbon. See indicatively: Chrysomallis M. (2010), *The Treaty of Lisbon and improving democracy and efficiency in the European Union*, N. Katsarou, p. 49 onwards.

<sup>37</sup> Official Journal, L 327, της 22/12/2000, p. 1

development of the OMC as a method of worthy of the Community and remain theoretically in the field as an intergovernmental tool that can coordinate actions, set benchmarks and take action but on a more limited, pilot field, guidelines for the environment in each Member State's policies.

In summary, in particularly sensitive areas, the OMC appears to be the primary choice which, precisely because of its flexibility and wide involvement of actors and actors, may bring about solutions which are not necessarily binding or even restrictive for Member States, which but they will in any case respect the principles of the Union (Scott & Trubek, 2002) and its Member- States. On the other hand, this move towards intergovernmentalism and the withdrawal of Member States' legal commitments, as the OMC promotes soft law procedures, bypasses (or even prevaricates) the Community method (Chalmers & Lodge, 2003; Goetschy, 2003; Scharpf, 2002) casts doubt on European constitution and respect for human rights (De Búrca, 2003). In addition, the disadvantages of the Method are the ineffectiveness, the lack of transparency and the lack of democratic legitimacy and accountability, not least because of the lack of involvement of the European Parliament in the process of adopting the reform agenda and its replacement by the European Council (Kröger, 2007) and lack of control due to the non-participation of the ECJ.

## References

- Barnier M. (2001). L'Europe n'aura pas le droit mou, article published in the newspaper Libération, 23/04/2002, available at: [https://www.liberation.fr/tribune/2001/04/23/1-europe-n-aura-pas-le-droit-mou\\_362084](https://www.liberation.fr/tribune/2001/04/23/1-europe-n-aura-pas-le-droit-mou_362084)
- Borrás S., Radaelli C. (2010). Recalibrating the Open Method of Coordination: Towards Diverse and More Effective Usages, Sieps, Report 7/2010: 31
- Chalmers D., Lodge M. (2003). The OMC and the European Welfare State, LSE Centre for Analysis of Risk and Regulation (ESRC). Discussion Paper No. 11/2003, LSE, London.
- Cooper A., Cooper R., Hughes C., Lombaerde P. (2008). *Regionalisation and global governance*. USA and Canada: Routledge.
- Crabit E., Bel N. (2016). Strengthening the Rule of Law in Europe: From a Common Concept to Mechanisms of implementation. In: W. Schroeder (ed.), *The EU Rule of Law framework*. Bloomsbury publications, Part IV, n. 13.
- De Búrca Gr. (2003). The Constitutional Challenge of New Governance in the EU, ELRev.
- European Commission, European Governance – A White Bible, COM (2001). final, Official Journal of the European Communities, C 287, 12.10.2001
- European Parliament, Report on the institutional and legal implications of the use of non-binding instruments (2007/2028 (INI)), Committee on Legal Affairs, available at: <http://europarl.europa.eu/sides/getDoc.do?pubRef=-//EP//NONSGML+REPORT+A6-2007-0259+0+DOC+PDF+V0//EL?>
- Fasensfest D., (2010). Government, Governing, and Governance, Wayne State University, Critical Sociology, 36(6): 771-774.
- Follesdal, A. and Hix, S. (2006). Why there is a Democratic Deficit in the EU: A Response to Majone and Moravcsik. *JCMS*, 44 (3): 533–62.
- Goetschy J. (2003). The European Employment Strategy, Multilevel Governance and Policy Coordination: Past Present and Future. In: J. Zeitlin & D. Trubek (eds.), *Governing Work and Welfare in a New Economy: European and American Experiments*. OUP, pp. 59 – 87.
- Hatzopoulos V. (2007). Why the open method of coordination is bad for you: a letter to the EU. *ELJ*, 13 (3): 312.
- Jacqué J. P. (2004). The principle of institutional balance, *CML Rev*: 383-391.
- Kohler- Koch, B., & Eising, R. (eds) (1999). *The Transformation of Governance in the European Union*. London: Routledge.

- Kröger S. (2007). The End of Democracy as We Know it? The Legitimacy Deficits of Bureaucratic Social Policy Governance. *JEI*: 565-582.
- Langenhove L., Costea A. (2007). The EU as a Global Actor and the Emergence of ‘Third Generation’ Regionalism. In: P. Foradori, P. Rosa, R. Scartezini (Eds.), *Managing a Multilevel Foreign Policy – the EU in International Affairs*. USA: Lexington Books.
- Langenhove L., Marchesi D. (2008). “The Lisbon Treaty and the Emergence of Third Generation Regional Integration”. Miami - Florida European Union Center, University of Miami, *Jean Monnet/Robert Schuman Paper Series* Vol. 8 No. 9, p. 10-11, available at: <http://aei.pitt.edu/9062/1/VanLangenhoveLisbonThirdGenerationLong08edi.pdf>
- McKormick, J. (2011). *European Union Politics*. New York: Palgrave MacMillan.
- Papadimitriou S. (2008). *The case law of the ECJ on the transposition of Community directives into the national order of the EU Member States*. Diki Publications.
- Radaelli C. (2003). The Open Method of Coordination: A new governance architecture for the European Union? Rapport nr 1, Swedish Institute for European Policy Studies.
- Scharpf F. (2002). The European Social Model: Coping with the Challenges of Legitimate Diversity. *JCMS*, 40 (4): 645-670.
- Scott J., Trubek D. (2002). Mind the Gap: Law and New Approaches to Governance in the European Union, *ELJ*: 1-18.
- Stephanou K. (2001). Objectives and Methods of the European Integration. In: Stephanou K., Fatours A., Christodoulidis Th. (eds), *Introduction to European Studies*, Volume A, History, Institutions and Law. Athens: ed. Sideri..
- Thomas J. (2009). The Democratic Deficit of the European Union, Center for Comparative and International Studies, ETH Zurich and University of Zurich, available at: [https://ethz.ch/content/dam/ethz/special-interest/gess/cis/cis-dam/CIS\\_DAM\\_2015/WorkingPapers/Living\\_Reviews\\_Democracy/Jensen.pdf](https://ethz.ch/content/dam/ethz/special-interest/gess/cis/cis-dam/CIS_DAM_2015/WorkingPapers/Living_Reviews_Democracy/Jensen.pdf)
- Tsatsos, D. (2007). The European co-state. Athens: publication A.A. Livani (in Greek).
- Vanhercke B.W.R. (2016). Inside the Social Open Method of Coordination: The hard politics of ‘soft’ governance, available at: [https://pure.uva.nl/ws/files/2737110/171885\\_04.pdf](https://pure.uva.nl/ws/files/2737110/171885_04.pdf)
- Weiler J.H.H. (2013). Democracy without the People: The Crisis of European Legitimacy “own resources”, at European Parliament, Challenges of multi-tier governance in the European Union, Effectiveness, efficiency and legitimacy (Compendium of Notes), Directorate General for Internal Policies Policy Department C: Citizens' Rights and Constitutional Affairs, available at: [http://www.europarl.europa.eu/RegData/etudes/etudes/join/2013/474438/IPOL-AFCO\\_ET\(2013\)474438\\_EN.pdf](http://www.europarl.europa.eu/RegData/etudes/etudes/join/2013/474438/IPOL-AFCO_ET(2013)474438_EN.pdf)
- Zeitlin J., (2012). The Open Method of Coordination: Effective and Legitimate? Presentation to CONNEX Mid-Term Review Conference, available at: <http://www.slideserve.com/demeter/the-open-method-of-coordination-effective-and-legitimate>

**TOPIC 4: ISSUES OF ENERGY AND SUSTAINABLE DEVELOPMENT**

#### 4.1. A game theoretic analysis of energy security in the Eastern Mediterranean

*Vasileios D. Papakostas<sup>1</sup>, Elissavet E. Bekou<sup>2</sup>, John A. Paravantis<sup>3</sup>*

##### Abstract

Energy has been elevated to a major concern in the eastern Mediterranean. Recent oil and gas discoveries in the area could affect Europe's energy dependency from Russia and provide an alternative for energy imports. However, opposing interests of neighboring states could cause turbulence which would seriously affect this prospect. This research examines the impact of Greece, Cyprus and Turkey foreign policy interactions on the energy security of the eastern Mediterranean. A game theoretic model was formulated to develop predictions about the future interactions. The equilibrium of this game was studied, taking into account the results of sensitivity analysis. Then, results showed that Turkey is likely to continue to not recognize (and violate) the Exclusive Economic Zone (EEZ) of Cyprus, while Cyprus will continue its activity in the disputed area. Turkey will also continue to dispute the Greek EEZ and its right to an expansion to 12 nautical miles. Turkey will likely try to seal delimitation agreements with Libya, bypassing Greek claims. In case Turkey fails to find an agreement with any of the littoral countries then its naval routes to Mediterranean will be blocked and it will be excluded by the hydrocarbon game in the area. This will affect the energy security of the region since Turkey is not expected to accept idly such a contingency. Nevertheless, armed conflict is likely to be avoided. The paper provides suggestions and urges for further study.

**Keywords:** Greece, Cyprus, Turkey, Aegean Sea, Eastern Mediterranean

##### Introduction

Important economic and political shifts have taken place in Turkey after 2011; coupled with global geopolitical shifts, these have developed into an uncertain new trajectory for Turkey. This period has been characterized as the "late AKP era" Müftüler-Baç & Keyman, 2012) (AKP: Justice and Development Party). AKP has been under the presidency of Erdogan in power since 2002, and has gradually brought Turkey nearer the principles of conservative Islam and state capitalism (Onis, 2019). At the same time, Turkey has adopted the role of a peripheral power that seeks to play a key role in the Eastern Mediterranean energy game.

Understanding and predicting Turkey's moves has become difficult recently due to the rapid and radical sociopolitical transformation of the country. This may partially justify the recent aggravation in the relationship of NATO with Turkey, as well as its rapprochement with Russia and Iran. The area of the Eastern Mediterranean is a complex system with great geopolitical significance. NATO, the European Union (EU), Russia, Iran and China have projected their interests regionally, which are coupled with the Greek and Cypriot claims in the Aegean and the Eastern Mediterranean Sea; Israeli interests in the Levant area; Egypt's continuous rise in the regional energy game of the area; the war in Syria and Iraq; and the Kurdish Liberation struggle. In this volatile geopolitical environment, inter-state relations are critical for the energy security of the region. Therefore, it is important to understand Turkey's national interests and foreign policy goals.

<sup>1</sup> Graduate Student, University of Piraeus, Greece. Email: va.papakostas@gmail.com

<sup>2</sup> Graduate Student, University of Piraeus, Greece.

<sup>3</sup> Associate Professor, University of Piraeus, Greece.

Recent hydrocarbon discoveries in the Eastern Mediterranean have elevated energy to a major geopolitical concern and have heated up the relationship of Turkey with Cyprus and Greece. Therefore, this work is focused on the Turkey-Greece-Cyprus triangle. Greece and Cyprus are opposed to Turkish national interests in the area. In case Greece and Cyprus manage to seal delimitation agreements between them and with other regional states, Turkey is in danger of being excluded from the hydrocarbon game of the Eastern Mediterranean and have its naval routes to Mediterranean blocked. Ongoing Turkish policy, future scenarios and objective limitations of its power need to be examined to assess effects on the energy security of the East Mediterranean region. As Greece is expected to start exploration activities soon, Turkey's reaction in possible scenarios of exclusion from the hydrocarbons game may seriously affect the energy security of the region.

## **Background**

This paper investigates the energy security of the Eastern Mediterranean, analyzing the opposing interests of Turkey with Cyprus and Greece with game-theoretic tools. The system which affects Turkish foreign policy in the Eastern Mediterranean is complex and multidimensional. Turkey, in order to obtain a dominant peripheral power status, is obligated to strengthen its economic and political influence on naval arteries that range from the Aegean to the Adriatic Sea and from the Suez Canal to the Red Sea. It appears inevitable for Turkey to adopt an offensive policy in the area of the Black Sea, the Aegean and the Mediterranean. The Turkish perspective is reflected in the view "*Eastern Mediterranean consists the same system with Aegean Sea*" (Davutoğlu, 2001).

NATO-Turkish-Russian relations are the most important factor that affects the Turkish strategy in the area. During the Cold War, NATO viewed the sovereignty of the Turkish Republic as an obstacle to the involvement of the Union of Soviet Socialist Republics (USSR) into the Mediterranean, and considered the preservation of its geopolitical position as an issue of paramount geopolitical significance (Austvik & Rzayeva, 2017).

Under Erdogan's rule, the exterior policy of Turkey is based on the assumption that its geo-economic and geopolitical interests are opposed to the interest of NATO members (Divsallar, 2019). Therefore, Turkey has moved further away from NATO and has adopted a policy of rapprochement towards Russia and Iran (Ozgaslam, 2018). This approach sculpts a new reality in the politics, the economy and the security of Turkey, with turbulence rising in the Eastern Mediterranean. Furthermore, Turkey's relations with Israel and the Arabic countries of the Eastern Mediterranean are a key point. The coalition of Athens-Nicosia-Jerusalem is a cause of alarm for Ankara, considering its strained relations with Egypt.

Greece and Cyprus are the main states which have directly opposed Turkish interests in the Aegean and the Eastern Mediterranean (Iseri & Andrikopoulos, 2013). A restrained Turkey in the Aegean Sea and the Eastern Mediterranean has narrow margins to play a key role in the energy game of the area. Thus, the primary strategic goal of Turkey is the maintenance of open naval routes through the Aegean and Cyprus (Davutoğlu, 2001). Equally important is the Turkish attempt of involvement into hydrocarbons exploration and production in the

region (Iseri & Andrikopoulos, 2013). The dispute over the EEZs of Greece and Cyprus affects these strategic goals.

So, the research question that this work seeks to answer is: How will Turkey, Greece and Cyprus react given the fact that their opposing interests can seriously affect the energy security of the Eastern Mediterranean? A game of sequential moves was set up between Cyprus, Turkey and Greece. Interviews with two academic experts, (one in International Relations and a second one on Turkey) were taken into consideration in building the game tree, and carrying out some basic sensitivity analysis. It was decided that the influence of other countries not be taken into consideration in the model.

### Greece-Cyprus-Turkey opposing interests

#### *Turkey-Cyprus current relations*

The aftermath of the 1974 Turkish invasion and occupation of the northern third of Cyprus island was the de facto division of Cyprus. Cyprus has effective control of the 59% of the island; the area that is not under its control comprises 37% of the island. The two de jure territories of the Republic are separated by a United Nations (UN) Buffer Zone which consists 4% of the island.

Turkey does not recognize Cyprus as a state. In 1983 the Turkish side declared independence and the Turkish Republic of Northern Cyprus (TRNC) was created. Under resolution 541 of the Security Council, the UN does not recognize TRNC as an independent state. Turkey is the only country that recognizes TRNC as an independent state and has established diplomatic relations with it.

Acting according to the EEZ and Continental Shelf Law, Cyprus established an EEZ and signed delimitation agreements with Egypt (2003), Lebanon (2007) and Israel (2010) (Cyprus Ministry of Foreign Affairs, 2016). The Cyprus EEZ is shown in Figure 1.

**Figure 1: Cyprus EEZ. Continuous line depicts the agreed EEZ border. Dashed line depicts Cyprus concept for EEZ delimitation.**

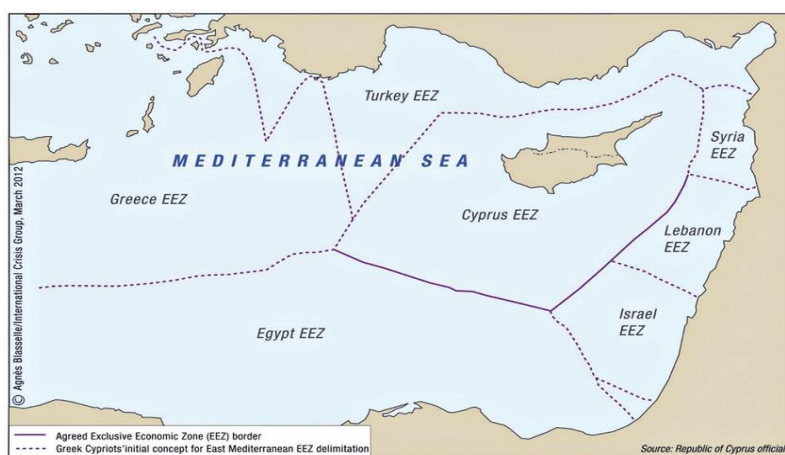

Source: Adamides & Christou (2016).

Cyprus has so far conducted and completed successfully three offshore licensing rounds, granting licenses to oil companies on both economic and diplomatic grounds. The target was to gain support and protection at a diplomatic level by states whose interests are served through these companies. Granted licenses to companies are shown in Figure 2.

**Figure 2: Granted Offshore Exploration licenses, issued by the Republic of Cyprus.**

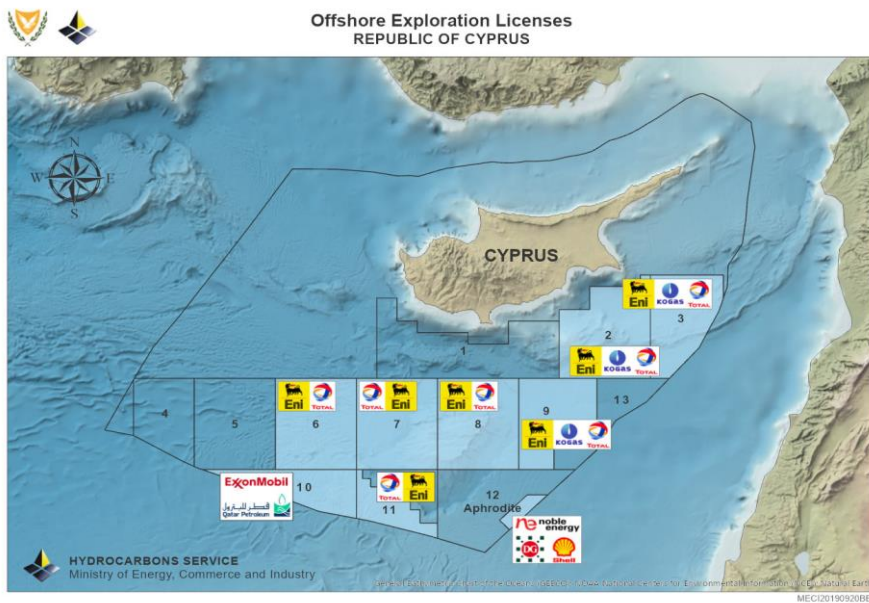

Source: Ministry of Energy, Commerce and Industry of Cyprus (2019).

On the other hand, the continental shelf claimed by Turkey covers almost all the claimed EEZ of Cyprus. More specifically, Turkish claims outline an area that “overlaps with parts of the Cyprus EEZ concession blocks that were announced in the context of the two international tenders for offshore hydrocarbon exploration licensing opened in 2007 and 2012, namely parts of Blocks 1, 4, 5, 6, and 7” (Gurel, Mullen & Tzimitras, 2013). Turkey made a delimitation agreement with the TRNC that overlaps and ignores the EEZ claimed by Cyprus, as illustrated in Figure 3. And TRNC itself proclaimed an EEZ which overlaps with the rest of the EEZ of Cyprus.

**Figure 3: Claimed Turkish continental shelf/EEZ in the Eastern Mediterranean Sea [13].**

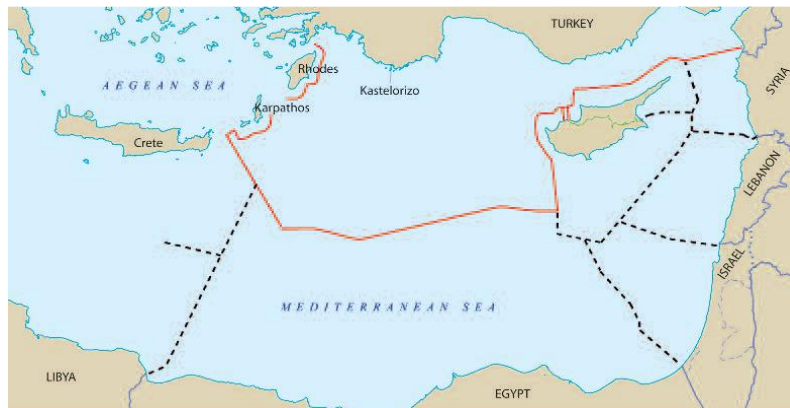

Source: Gurel, Mullen & Tzimitras (2013).



Since then, Turkey has been following a strategy of signing bilateral agreements with the TRNC on a basis of the claimed EEZ by the two sides. Based on these agreements, Turkey recently sent exploration and drilling ships in the area, violating the EEZ claimed by the Republic of Cyprus and causing tension in the area.

According to reports of the European Parliament (Vozemberg-Vrionidi, 2017) Turkey submitted a letter to the UN, threatening to invoke *casus belli* against both Nicosia and the two companies that were awarded block 6 of the EEZ of Cyprus. The document not only challenges Cyprus' ability to conduct exploration and issue permits for certain blocks, but also asserts that a part of block 6 belongs to the Turkish continental shelf. Cyprus ignored that threat, and Turkey decided to proceed with exploration and drilling operations within the EEZ of Cyprus. A statement by Ms. Federica Mogherini, the High Representative of the EU for Foreign Affairs and Security Policy, on Turkey's activities within EEZ of Cyprus, claimed that "*we (the EU) urgently call on Turkey to show restraint, respect the sovereign rights of Cyprus in its EEZ and refrain from any such illegal action to which the European Union will respond appropriately and in full solidarity with Cyprus*" (Mogherini, 2019). In response, Turkey's foreign affairs minister Cavusoglu sent a letter to the EU Chief of foreign policy claiming that "*Turkey should not be expected to sit idly and condone the ongoing violation of its rights and those of the Turkish Cypriots*" (Daily Sabah, 2019).

#### *Turkey-Greece current relations*

The dispute between Turkey and Greece has to do with the Aegean Sea. Turkey's main targets in the Aegean Sea are to maintain its sea transport corridors open, and thwart Greek hydrocarbons exploration or exploitation. The oil potential of the Aegean was in fact the primary reason that led Turkey to dispute the continental shelf during the 1970s (along with almost the entire legal regime of the Aegean).

The continental shelf concept was not foreseen in the provisions of the 1923 Treaty of Lausanne which, among other issues, established the status quo of the Aegean Sea. In 1936 Greece decided to expand its territorial waters from three to six nautical miles (nm). In 1964 Turkey opposed this, and Greece submitted the case to the International Court of Justice (ICJ) in 1976. It is noted that this was prior to the ratification of the United Nations Convention on the Law of the Sea (UNCLOS); Turkey refused to recognize the jurisdiction of ICJ at the time, and Greece's application for arbitration was not entertained (Cubukcuoglu, 2014).

Since the early 1970s, Turkey has adopted a policy of contentions and claims in the Aegean Sea. This has drawn a canvas of ever-increasing disputes, initiated by the dispute over the delimitation of the continental shelf in 1973. Furthermore, since the 1990s Turkish officials have developed the theory of grey zones, which questions the sovereignty of certain Greek islands, islets and rocks in the Aegean (Heraclides, 2010) Greece and Turkey came to the brink of armed conflict during the 1987 and 1996 crises, which stemmed from Turkish disputes Greek sovereignty in the Aegean.

#### Invoking

the International Law of the Sea, Greece claims the right to extend its territorial waters to 12 nm at any time. Because Greece has sovereignty over thousands of islands in the area, in such a case it would control almost three fourths of the Aegean Sea, as illustrated in Figure 4.

**Figure 4: Greek and Turkish territorial sea width in the Aegean in the context of 6 and 12 nm Greek territorial sea limit, respectively**

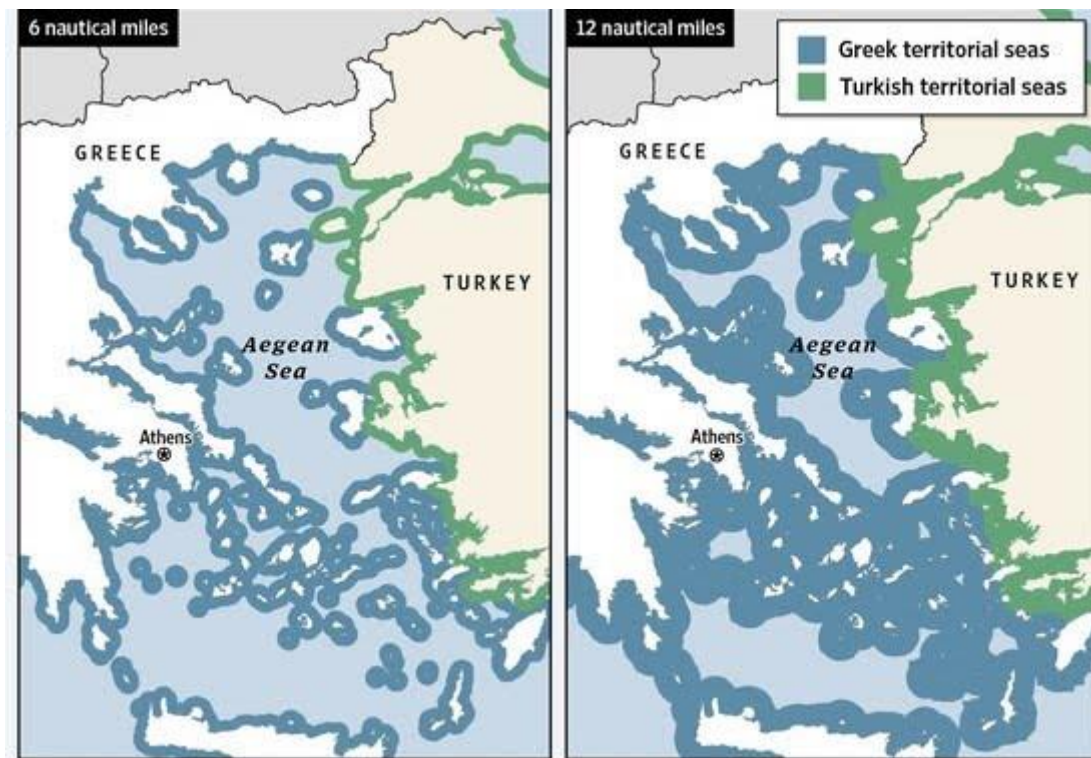

Source: Papadakis (2018).

Greece's legal position about settlement of the EEZ dispute relates to the principle that *"islands have full right to exercise jurisdiction over their CS and coextensive EEZs as per Article 121 of UNCLOS"* (Cubukcuoglu, 2014). Turkey contests this right on a *casus belli* issued by the Turkish National Assembly in 1995, granting the Turkish government full and perpetual competence to declare war, should Greece decide to extend its territorial waters beyond six nm. Furthermore, Turkey claims that *"Greek islands do not have rights to exert jurisdiction on the continental shelf, because they are located on the Turkish continental shelf"* (Siousouras & Chrysochoou, 2014). The two different perspective of the two countries are illustrated in Figure 5.

**Figure 5: The Turkish Continental Shelf according to the Greek view (in orange) and the Turkish view (intermittent line).**

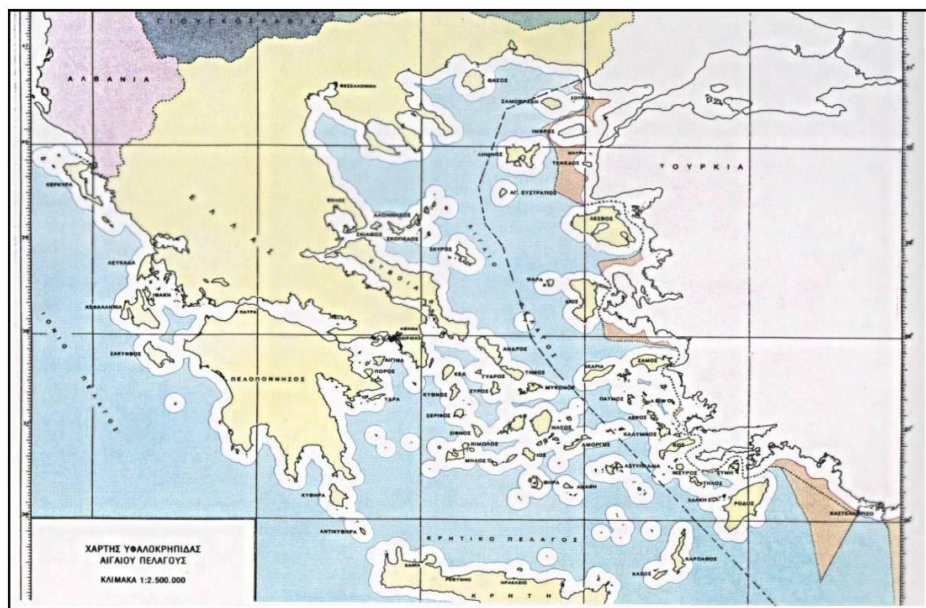

Source: Siousouras & Chrysochoou (2014).

Although Greece has not extended its EEZ to 12 nm thus far, it has attempted to seal agreements with Albania and Italy on delimitation of its EEZ in the Ionian Sea. Greece has already awarded licenses for hydrocarbon exploration and production in the southwest of Crete, as shown in Figure 6.

**Figure 6: The licensed and available for licensing areas by Greece to oil companies for exploration of hydrocarbons.**

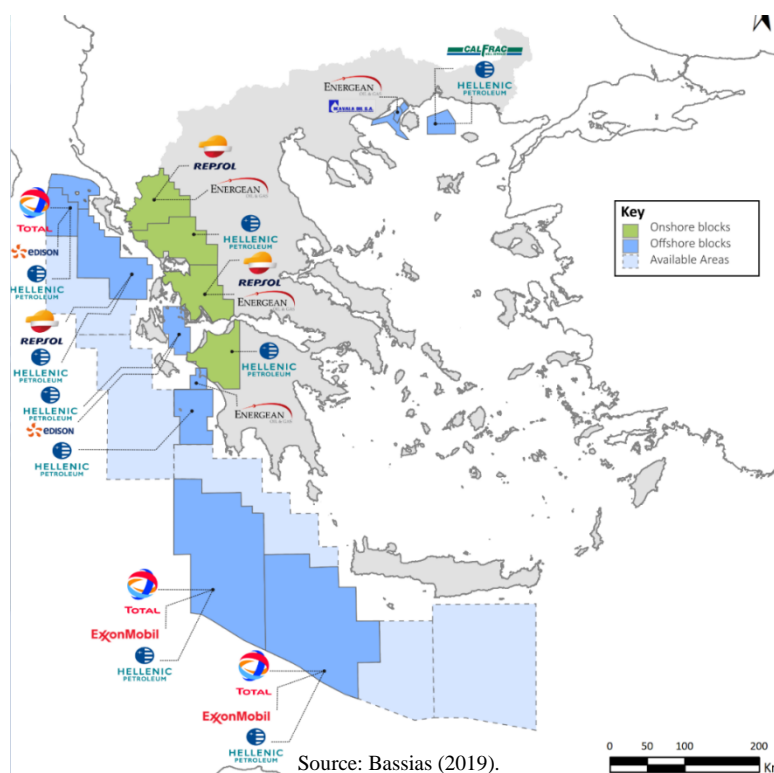

In the worst-case scenario for Turkey, Greece would sign maritime demarcation agreements with Libya, Egypt and Cyprus; Turkey's naval routes would be blocked, and Turkey will be totally excluded from the hydrocarbon exploration and exploitation game in the area.

### **Game theoretic approach**

To explore the interactions among Cyprus, Turkey and Greece in the energy arena of the Eastern Mediterranean, a game of sequential moves was set up.

Interviews were held with two academic researchers, an expert on International Relations (IR) and strategy, and an expert on Turkey. The interviews were loosely structured around a small number of open-ended questions, with follow up on any interesting leads that came up. The IR expert suggested that the Eastern Mediterranean is a region that harbors significant geopolitical dangers, and may create conflict that can spread easily. The Turkey expert suggested that Turkey felt betrayed by the failure of the Cyprus Reunification (Annan) plan; emphasized the importance of alliances for a weak player like Cyprus; and believed that Turkey would not stray from a foreign policy path that was (perceived as) halfway between pacifism and belligerence.

The collated results of the two expert interviews were taken into consideration when constructing the game tree, and trimming down a longer list of alternative strategies. It was assumed that Cyprus moves first, followed by Turkey and Greece. The following alternative strategies were available to each player: (1) Cyprus: aggressive strategy (AS), strategy of the weak player (SWP), and submissive strategy (SS); (2) Turkey: aggressive strategy (AS), neutral strategy (NS), and pacifist strategy (PS); and (3) Greece: aggressive strategy (AS), dispassionate strategy (DS), and submissive strategy (SS). Based on the points raised during the interviews, it was also decided that the influence of other states be excluded from the game theoretic model, and only be studied at a qualitative level.

The game tree is illustrated in Figure 7. The payoffs reflect plain ordinal values, and were assigned by consensus of the research team. The Nash equilibrium, indicated with thick black lines, is defined by the path: Cyprus (CY) selects the SWP strategy; Turkey (TR) selects the AS strategy; and Greece (GR) selects the DS strategy. The final payoffs received at the equilibrium outcome were five, three and three, for Cyprus, Turkey and Greece respectively.

Per the game tree, Cyprus appears to enjoy a first mover comparative advantage. As long as Cyprus does not halt exploration activities by oil companies in its EEZ, and continues to follow a SWP, its payoff will be equal to five, second only to a payoff of six obtained at two other outcomes that would occur if Turkey adopted a NS.

**Figure 7: Game theoretic model (thick black lines indicate Nash equilibrium; AS: Aggressive Strategy, DS: Dispassionate Strategy; NS: Neutral Strategy, PS: Pacifist Strategy, SS: Submissive Strategy, SWP: Strategy of the Weak Player)**

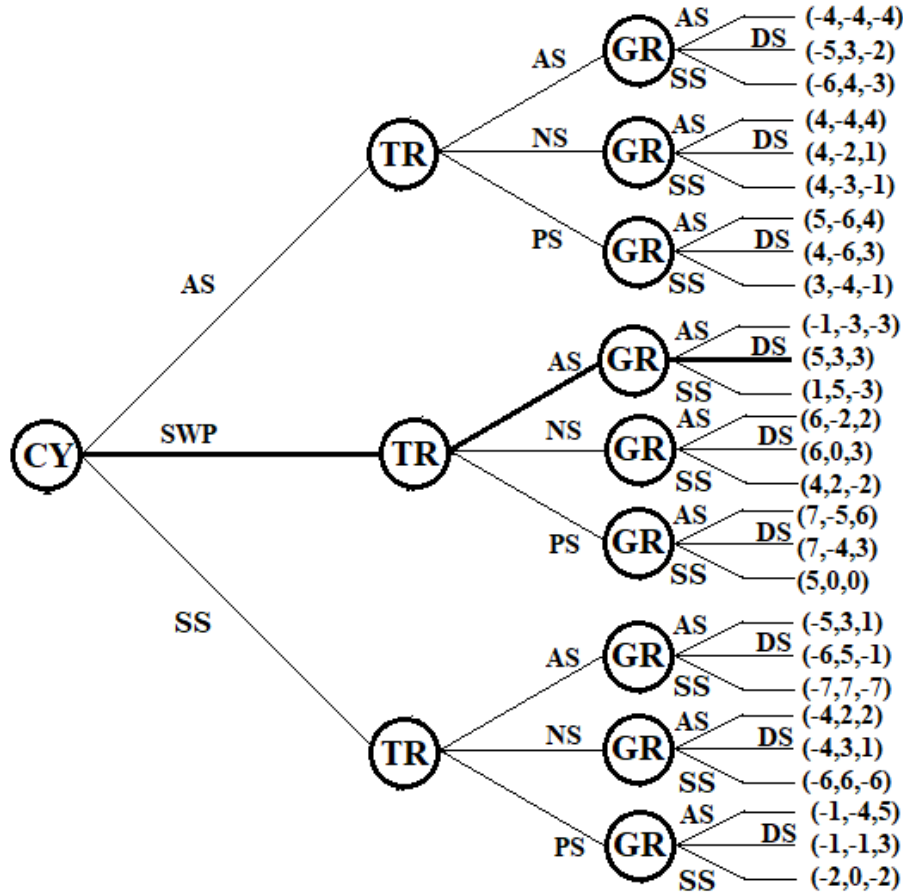

For Cyprus, the SWP means seeking to seal agreements based on international law, with states and companies that share common interests and have the power to safeguard Cypriot interests. It is unrealistic for Cyprus to adopt an aggressive strategy towards Turkey due to the absence of military might. If Cyprus followed a submissive strategy towards Turkey, it would be forced to halt all exploration activities in its EEZ, cancel the contracts with oil companies and face both legal and economic consequences. In such a case, the sovereignty and integrity of the Cypriot state would be lost.

Considering that Cyprus will follow the strategy of the weak player, analysis suggested that Turkey will adopt an aggressive strategy. Turkey does not recognize the Cypriot EEZ, and considers all the oil and gas explorations under Cypriot license to be illegal. Therefore, Turkey will continue to violate the Cypriot EEZ with both drill ships and warships. Turkey hopes that this will have a double impact in the situation: first, by directly exposing Cyprus as a state which cannot guarantee the safety of oil companies in the area, and subsequently forcing them to cancel or halt its operations; second, by forcing Cyprus to accept Turkish claims and demands.

If Turkey followed a neutral strategy, it would lose a big cut of its claims since TRNC would have to reach an agreement with Cyprus; such an agreement would most likely be in favor of the Cypriot side, given that contracts are already signed with oil companies, and exploration activity has begun. In case Turkey followed a pacifist strategy, it would eventually lose all its claims as well as the claims of TRNC.

Turkey is expected to follow the same strategy concerning its claims on the Greek EEZ, although things are more complicated in this case. In the presence of Greek military might, Turkey is likely to be less aggressive and more cautious with possible violations of the Greek EEZ with drillships and warships. However, it is expected to continue to dispute the EEZ of Greek islands, and try to seal delimitation agreement with Libya. These would cause legal issues with the licenses that the Greek state has already signed for the exploration and exploitation of hydrocarbons south of Crete. Furthermore, given that a *casus belli* exists over the possibility of declaration of a 12 nm EEZ by Greece in the Aegean, Turkey will put all its force behind presenting this threat as real and valid, to deter Greece from such an action. Otherwise, Turkey would be directly excluded from the energy game both in the Aegean and the Eastern Mediterranean, and its naval routes would be blocked.

Considering the strategies that will likely be adopted by Cyprus and Turkey, Greece may maximize its payoffs by following a dispassionate strategy. This means that Greece will try to deter any military action by Turkey both in the Aegean and Cyprus, while simultaneously trying to safeguard its rights at a diplomatic level. Greece is expected to attempt signing delimitation agreements with Egypt and Cyprus while thwarting any delimitation agreement between Libya and Turkey. Given the unstable political situation in Libya, Greece would be expected to try to seal its own delimitation agreement with Libya under favorable circumstances.

An aggressive strategy by Greece is not likely, due to the fact that its army has adopted a defensive doctrine towards Turkey and is focused on safeguarding state interests, integrity and sovereignty in the region. If Greece adopted an aggressive strategy, a war would likely be unavoidable, which could mean disastrous results for all sides. Greece is not expected to follow a submissive strategy due to the fact that this would constitute a *de facto* and possibly *de jure* acceptance of Turkish claims in the Aegean and Eastern Mediterranean. In this case, Greek islands would lie within the Turkish EEZ, so Turkey would undoubtedly claim them as part of the Turkish state. Exploration activities south of Crete would have to halt too, and Greece would have to pay huge refunds to the oil companies. This would also mean that, although Greece has signed the UNCLOS, it was *de facto* not applying it and would not be able to invoke it in any of its delimitation talks with littoral states in the Ionian Sea or the Mediterranean. The latter applies for Cyprus too, if it adopted a submissive strategy.

Two issues were explored in the context of sensitivity analysis: alternative structures of the game tree (mostly related to which state moves first), and a limited range of payoffs. The results of the expert interviews discounted alternative game tree formulations as lacking credibility. As to the payoffs, although no details are shown here, sensitivity analysis supported the assertion that the game tree presented in Figure 7 and the resulting Nash equilibrium represent the most likely strategic interaction among the three states.

To sum up the game theoretic analysis, equilibrium showed that all three states are best off when Cyprus adopts the strategy of a weak player; Turkey adopts an aggressive strategy; and Greece adopts a dispassionate strategy. Turkey will not follow a neutral or pacifist strategy, and Greece and Cyprus will not follow a (fully) submissive strategy. War will be avoided.

## **Conclusions**

This research showed that Turkey, Cyprus and Greece will make the best of what power they have, and continue to be entangled in an unusual sort of a chicken game where everyone understands that blinking is ultimately unavoidable. Cyprus will strive to secure its oil and gas exploration and exploitation rights, which will boost its economy and diplomatic status while simultaneously shield its integrity and sovereignty. Turkey will try to maintain its naval routes from the Black Sea to the Mediterranean open, and participate in the hydrocarbons game of the Eastern Mediterranean. Finally, Greece will try to initiate oil and gas exploration and exploitation activities both in the Aegean and the Eastern Mediterranean while protecting its integrity and sovereignty.

Turkey will probably continue to violate Cyprus' EEZ, aiming to disrupt exploration or production of hydrocarbons in the area. This will affect the energy security of Cyprus. Turkey is unlikely to get involved into a war with Greece. It will continue to challenge the Greek EEZ, and try to seal a delimitation agreement with Libya. If Turkey fails to find an agreement with any of the littoral countries, its naval routes to Mediterranean will be blocked and it will be excluded by the hydrocarbon game in the area. This will affect the energy security of the region negatively, since Turkey is not expected to accept idly any oil and gas exploration or exploitation in the area without its involvement.

So, Turkey will likely manage to secure a part of the resource pie; Greece will likely maintain a dispassionate stance; and Cyprus will strengthen its positions by diplomatic means, bringing more countries into the game; war will be avoided.

Using game theoretic tools to analyze geopolitical conflict allows the introduction of quantitative tools into an inherently qualitative endeavor. Yet, game theoretic models become exponentially unwieldy as more players and strategies are added. Third parties such as the European Union, Russia and Libya will affect aspects of the situation. A future reexamination of the situation as events unfold is necessary.

## **Acknowledgments**

The authors thank Drs. T. Nadasdi and S. Sinclair for their online Spell Check Plus (<http://spellcheckplus.com>) that was used for proofing the entire manuscript. This work has been partly supported by the University of Piraeus Research Center.

## References

- Adamides, C. and Christou, O. (2016). Can Resolving Cyprus Hold the Key to Regional Energy Cooperation? *Turkish Policy Quarterly*, 15: 85-94.
- Austvik, O.G. and Rzayeva, G. (2017). Turkey in the Geopolitics of Energy. *Energy Policy*, 107: 539-547.
- Bassias, Y. (2019). Beyond the search for hydrocarbons in Greece. Hellenic Hydrocarbons Resources Management, 1<sup>st</sup> Annual Eastern Mediterranean Energy Leadership Summit. 2019. Available at: [https://www.greekhydrocarbons.gr/news\\_en/HHRM\\_SEMED\\_SUMMIT\\_1\\_October\\_2019.pdf](https://www.greekhydrocarbons.gr/news_en/HHRM_SEMED_SUMMIT_1_October_2019.pdf)
- Cubukcuoglu, S.S. (2014). Turkey's EEZ in the Mediterranean Sea: The Case of Kastellorizo. Published Master Thesis, Boston, USA: TUFTS University, The Fletcher School of Law and Diplomacy.
- Cyprus Ministry of Foreign Affairs (2016). Exclusive Economic Zone and Continental Shelf. Nicosia: Cyprus Ministry of Foreign Affairs, available at: [http://www.mfa.gov.cy/mfa/mfa2016.nsf/mfa86\\_en/mfa86\\_en?OpenDocument](http://www.mfa.gov.cy/mfa/mfa2016.nsf/mfa86_en/mfa86_en?OpenDocument)
- Daily Sabah (2019). Turkey drilling in own territorial waters. Daily Sabah article. Available at: <https://www.dailysabah.com/diplomacy/2019/05/17/turkey-drilling-in-own-territorial-waters-fm-cavusoglu-says-in-letter-to-eu-un>
- Davutoğlu, A. (2001). *Stratejikderinlik: Türkiye'ninuluslararasıkomumu*. Aksaray, İstanbul: KüreYayınları.
- Divsallar, A. (2019). The Pillars of Iranian-Russian Security Convergence. *The International Spectator, Italian Journal of International Affairs*, 54 (3): 1-16.
- Gurel, A. Mullen, F. and Tzimitras, H. (2013). *The Cyprus Hydrocarbons Issue: Context, Positions and Future Scenarios*. Oslo: Peace Research Institute Oslo (PRIO).
- Heraclides, A. (2010). Imia/Kardak and the Gray Zones. *New Perspectives on South-East Europe, The Greek-Turkish Conflict in the Aegean*, 209-213.
- Iseri, E. and Andrikopoulos, P. (2013). Energy Geopolitics of the Eastern Mediterranean: Will Aphrodite's Lure Fuel Peace in Cyprus? *Middle Eastern Analysis*, vol.5, 2013.
- Ministry of Energy, Commerce and Industry of Cyprus (2019). Hydrocarbons Service. Available at: [http://www.mcit.gov.cy/mcit/hydrocarbon.nsf/page16\\_en/page16\\_en?OpenDocument](http://www.mcit.gov.cy/mcit/hydrocarbon.nsf/page16_en/page16_en?OpenDocument)
- Mogherini, F. (2019). Statement by High Representative/Vice-President Federica Mogherini on Turkey's intended drilling activities within the exclusive economic zone of Cyprus. Bruxelles, 4/5/2019, available at: [https://eeas.europa.eu/headquarters/headquarters-homepage/61836/statement-high-representativevice-president-federica-mogherini-turkeys-intended-drilling\\_en](https://eeas.europa.eu/headquarters/headquarters-homepage/61836/statement-high-representativevice-president-federica-mogherini-turkeys-intended-drilling_en)
- Müftüler-Baç, M. and Keyman, F. (2012). The era of dominant party politics. *Journal of Democracy*, 23: 85-99.
- Onis, Z. (2019). Turkey under the challenge of state capitalism: the political economy of the late AKP era. *Southeast European and Black Sea Studies*, 19 (2): 201-225.
- Ozgaslam, M.T. (2018). Russia-Turkey Relations: Conflict and Limited Cooperation in the Post-Soviet Era. *The European Proceedings of Social & Behavioural Sciences EpsBS*, 137: 81-89.
- Papadakis, K. (2018). The Greece - Turkey Dispute in the Aegean and the ICJ Sea Border Delimitation Case of Ukraine – Romania. Similarities and differences in a comparative perspective. *European Quarterly of Political Attitudes and Mentalities*, 7: 36-46.
- Sioussouras, P. and Chrysochoou, G. (2014). The Aegean Dispute in the Context of Contemporary Judicial Decisions on Maritime Delimitation. *Laws*, 3: 12-49.
- Vozemberg-Vrionidi, E. (2017). Turkish threats aimed at Cypriot Exclusive Economic Zone. European Parliament, Parliamentary Questions, 2017, available at: [http://www.europarl.europa.eu/doceo/document/E-8-2017-003098\\_EN.html](http://www.europarl.europa.eu/doceo/document/E-8-2017-003098_EN.html)



## 4.2. Carbon Pricing: recent developments in European Union

*Christos Bentsos<sup>1</sup>*

### **Abstract**

This paper summarizes the contemporary issues on carbon pricing in European Union concentrating mainly on the EU – Emission Permits Scheme (EU-ETS). Firstly, the forces and the main treatments concerning the combat of climate change which led to the establishment of the EU – ETS are referred. Then, the carbon pricing initiatives are discussed as well as the effective carbon rates and their components. The next topics have to do with the challenges of carbon pricing initiatives, their financial aspect, and the carbon pricing corridors. Then the paper is focused on the EU-ETS. The way that system works theoretically, and the implementation phases are examined. More specific, the permits' allocation to countries through the phases, benchmarks, auctions' conduction and revenues' use are analyzed. Issues which are investigated concern the union registry, the monitoring, reporting and verification and the compliance cycle. The following topic associated with the carbon price concentrating on determinant factors and price evolution during Phase I and II. Then EU ETS effects on firms' competitiveness and EU-ETS after Brexit and 2020 are also discussed. Lastly, the recent developments in shipping industry are discussed.

**Keywords:** EU ETS, carbon price, European climate policy, carbon tax, shipping

### **1. Introduction**

Climate change, limited fossil fuels and energy security lead the governments around the world and especially in European Union to environmentally friendly policies. For European Union the combat of climate change constitutes the cornerstone of its ideology and at this paper I examine through literature review the EU's main policies on reducing greenhouse gas emissions.

One of the five pillars of European energy policy is to reduce GHG emissions. The other four are the security of energy supply, to complete the internal energy market, to improve energy efficiency and to increase R&D. Climate policies either might have not been designed for climate change issue but have impacts on GHG emissions or they might be related to climate. The first category includes: structural reform policies, price and subsidy policies, and liberalization of energy industries (Bhattacharyya, 2011). Specific policies for climate include regulatory approaches, carbon tax and other charges, voluntary agreements and tradeable permits.

European Union has contributed significantly to signing three international agreements for the climate change: The United Nations Framework Convention on Climate Change (UNFCCC) in 1992, the Kyoto Protocol in 1997 (Mardas, 2013) and the Paris Agreement in 2015.

Back to 1988, the International panel on climate change was established. Three years later, in 1992 the UNFCCC was agreed and in 1994 was enforced. However, the mechanisms to control the climate change were not specified (Bhattacharyya, 2011). In 1995, at Berlin, countries recognized the need of additional treaty under UNFCCC regarding reduction commitments for developed countries (European Commission, 2015a).

---

<sup>1</sup> MSc Energy and Finance, International Hellenic University, Email: christosbentsos@gmail.com

In 1997, the Kyoto Protocol was signed and in 2005 entered into force. It was an ambitious attempt to construct an international climate-change agreement to harmonize the policies of different countries. Meanwhile, in 2001, the Marrakesh Accord set the rulebook for the Kyoto Protocol implementation. In 2009, the Copenhagen Accord failed to agree on a success for Kyoto Protocol. In 2012, at Doha, there was an agreement on the amendment of Kyoto Protocol. The developed countries decided to deteriorate their collective emissions by 5.2% below 1990 levels during 2008–2012 (Bhattacharyya, 2011). The Kyoto Protocol authorized three cooperative implementation mechanisms that involved tradable allowances: Emission Trading, Joint Implementation (JI), and the Clean Development Mechanism (CDM) (Tietenberg & Lewis, 2012). However, countries did not find the Kyoto Protocol economically attractive and the developing countries had not been attracted (Cramton, MacKay, Ockenfels, & Stoft, 2017).

The European Commission presented in March 2000 a green paper on “Greenhouse gas emissions trading within the European Union” with some first concepts on the design of the EU ETS. In 2003 EU ETS Directive adopted and in 2005 the EU ETS introduced (Commission, EU ETS Handbook, 2015b). The European Emission Permits Scheme is a multycountry cap-and-trade system and implements the Kyoto Protocol. It is a market which was created by political decisions.

In December 2017, at the One Planet Summit leaders of governments, businesses and international organizations, came together to discuss ways to support and accelerate global efforts to combat climate change. 88 parties submitted their nationally determined contributions to the Paris Agreement, representing 56% of global GHG emissions. It was stated that they are planning or considering the use of carbon pricing as a tool to meet their commitments (World Bank, 2018).

## **2. Carbon pricing initiatives**

Carbon pricing is an effective and low cost mean of reducing CO<sub>2</sub> emissions. Carbon pricing initiatives can serve both environmental and social objectives. This includes emissions trading systems (ETSs), offset mechanisms, carbon taxes, and results-based climate finance (RBCF). The main goal is to stimulate cost-effective emissions mitigation. However, broader outcomes can be achieved, like progress in low-carbon technology and deterioration of negative effects of fossil fuels on public health (World Bank, 2018)

Carbon prices can be effective for reducing emissions because they increase the price of carbon-based energy, so decrease the demand. They can lead to lower demand for energy overall as well as to substitution towards less carbon-intensive forms of energy. In general, the extent to which carbon prices reduce emissions depends on the level of the carbon price and on the availability of substitutes. The scope for substitution varies between sectors and countries (OECD, 2016).

Nowadays national and subnational jurisdictions, as well as private sector entities adopt carbon pricing. The Paris Agreement is likely to drive this momentum further due to the operationalization of Article 6 (World

Bank, 2018). Emissions trading, as well as sustained investment in low and zero carbon technologies which require high and stable permit prices can be effective options (OECD, 2016).

To date, 51 carbon pricing initiatives have been implemented or are scheduled for implementation. Half of them are ETSs, while the others refer to carbon taxes implemented on national level. These carbon pricing initiatives would cover 11 gigatons of carbon dioxide which is about 20% of global greenhouse gas emissions. The total value of these initiatives, in 2018, was about \$82 billion, representing a 56% increase compared to the 2017 value of \$52 billion (World Bank, 2018). In Europe, an ETS has been implemented as well as a carbon tax in many countries like the UK, France, Spain, Sweden while in Belgium carbon tax is under consideration.

However, a report showed that 90% of carbon emissions are not priced at a level reflecting even a conservative estimate of their climate cost. The report involved 41 countries covering 80% of global energy use. Across the 41 countries, 60% of carbon emissions from energy use were unpriced and only 10% of emissions were priced at an effective carbon rate equal 30€ per ton of CO<sub>2</sub> (OECD, 2016).

### 3. Effective carbon rates (ECRs)

ECRs are the sum of carbon taxes, specific taxes on energy use and tradable emission permit prices, expressed in € per ton of CO<sub>2</sub> emissions. Carbon tax rates are usually set for each fuel based on their CO<sub>2</sub> content. In case there is a fixed rate per unit of CO<sub>2</sub>, the result is a uniform carbon tax. Specific taxes on energy use commonly excise taxes, like taxes on transport fuels, heating and process fuels, and fuels for electricity generation. The third component of ECRs is the price resulting from emissions trading systems (OECD, 2016).

Taxes are higher and more uniform in road transport, and lower and more variable in other sectors in the most countries. The highest rates observed to oil products. As for electricity, taxes are related to consumption. The ETSs have the highest coverage in electricity and industrial sectors (OECD, 2016).

Carbon prices vary, from less than \$1/tCO<sub>2</sub> to \$139/tCO<sub>2</sub>. The highest prices are in Europe and are expressed as taxes. In Asia the prices are less than \$10/tCO<sub>2</sub> while in North America prices are about \$15/tCO<sub>2</sub>. Sweden has the highest price at \$139 and Switzerland with Liechtenstein follow at \$101. The price at EU ETS, during the first semester of 2019, fluctuates between 22 and 29 euros.

Most initiatives increased in 2018 compared to 2017. One substantial change was the growth in the European Union Allowance (EUA) price from €5/tCO<sub>2</sub> to €13/tCO<sub>2</sub> and €28/tCO<sub>2</sub> at 2019. Moreover, planned tax rate increased, including the escalation of the France carbon tax rate from €30.5/tCO<sub>2</sub> to €44.6/tCO<sub>2</sub>. In 2018, the total value of ETSs and carbon taxes was \$82 billion, in contrast with the 2017 value of \$52 billion. This increase reflects an increase in the EUA price and the carbon tax rate in France (World Bank, 2018).

#### **4.1. How EU ETS works**

The European Emission Permits Scheme is a cap-and-trade system and operates in 30 countries (the 27 EU Member States plus Iceland, Liechtenstein and Norway). That means that a government can set a limit on GHG emissions for companies (cap) and then allow them to “trade” these rights in the market (Chung, Jeong, & Young, 2018). More specifically, cap refers to a limit on the total amount of certain greenhouse gases that can be emitted. There are two types of caps. The absolute emission cap which refers to a fixed number of tons over a set time period and the relative emission cap which refers to a proportion to some variables like the economic output e.g. kg CO<sub>2</sub>/MWh (Commission, ETS Summer University, 2015a). Within this cap, companies receive emission allowances which they can be sold or bought from one another. So, with the introduction of the EU-ETS, carbon emissions are capped, traded and priced. The EU-ETS covers about 50% of the European Union’s CO<sub>2</sub> emissions and 40% of its total GHG emissions (Schleich, Rogge, & Betz, 2009).

EU allocates to each country (jurisdiction) a maximum limit on the total amount of permitted emissions, which are then distributed to firms. Each allowance represents the right to emit one ton of CO<sub>2</sub> per year. Entities that pollute more than the allowances they receive, have to purchase extra allowances in the open market from firms that use less allowances than they receive. This incurs cash expenses for the firms and increases their marginal production cost. In contrast, firms with lower emissions may need to buy less additional permits and, in this way, reduce their marginal production cost or sell in the exchange their unused given permits and benefit from additional revenues (Tsouknidis, et al., 2019).

#### **4.2. EU – ETS implementation phases**

EU-ETS was set up in 2005 and is now in its third phase. The first three-year phase was a pilot phase and ran from 2005 to 2007. It was aiming to ensure that the EU ETS functioned effectively ahead of 2008. During this phase, price formation was tested and the necessary infrastructure for monitoring, reporting and verification of emissions was established. The cap was largely based on estimates as there was not any reliable emission data available (Commission, EU ETS Handbook, 2015b). At this phase only, CO<sub>2</sub> emissions were covered which came from iron and steel, minerals, energy, and pulp and paper (Tietenberg & Lewis, 2012). Moreover, only the 25-member states of EU participated. The countries set their own cap through national allocation plans (NAPs) and the allowances were free of charge. The participants were not allowed to bank allowances for the next phase and the penalty for non-compliance was 40€/ton CO<sub>2</sub> (Commission, ETS Summer University, 2015a).

The second five-year phase ran from 2008 to 2012, the same period as the first commitment period under the Kyoto Protocol. It was aiming to further operationalization. Norway, Iceland and Liechtenstein also participated (Commission, EU ETS Handbook, 2015b). The national allocation plans were replaced by a central allocation system and the penalty for non-compliance was 100€/ton CO<sub>2</sub> (Clara & Mayr, 2018). In the second phase, allowances could be banked for the next phase. In the first two phases the majority of allowances were allocated free of charge based on historic emissions (“grandfathering”) (Duscha, 2018).

The third eight-year phase of the EU ETS which started in 2013 and is running until 2020, was shaped by the lessons learnt from the previous two phases. This period coincides with the second commitment period of Kyoto Protocol. Significant efforts were taken to improve the harmonization of the scheme across the EU. Croatia was the new country that participated during this period while the new sectors to whom the scheme expanded were the petrochemicals and the aluminum (Commission, EU ETS Handbook, 2015b). Allowances were allocated via auctions. Moreover, except CO<sub>2</sub> emissions, N<sub>2</sub>O and PFC were also covered. The NER300 was founded, aiming to fund the development of specific low-carbon technologies (Clara & Mayr, 2018).

### 4.3. Allocation and distribution

There are three main approaches to allocate allowances: allocation according to historic emissions or grandfathering, allocation according to benchmarks and auctioning. During the first two phases, allocation was free of charge and based on national allocation plans and grandfathering (Eichhammer, et al., 2018). Each member state allocated a part of its GHG reduction target under the burden sharing arrangement of the EU. Then the state decided how much of this target will be allocated to each participating sector and how the sectoral target will be assigned to each installation. This was done through the NAPs (Bhattacharyya, 2011). This decentralized approach was criticized because created substantial differences in allocations across countries that could cause competitive distortions (Eichhammer, et al., 2018).

In the third phase, allowances which were provided free, were reduced and auctioning became the default method for allowance distribution. However, installations from the refineries and industry sector continue to receive allowances free of charge based on benchmarks (Duscha, 2018). Through auctioning each emitter buys the number of permits that it needs and can afford to pay. At this Phase, free allocation is based on fixed benchmark values and historic production levels in a pre-defined base period (Duscha, 2018). For the New Entrant Reserve (NER) 5% of the total quantity of allowances is set aside for free allocation (Commission, EU ETS Handbook, 2015b). Benchmark is a reference value for the greenhouse gas emissions, relative to a production activity and work as follows. Firstly, it is based on expected output for new entrants. Meanwhile the allocation is continuously updated based on actual production. If production is less than expected, the firm must return the share of its free allowances; otherwise it receives additional allowances. Finally, allocation of the next period is recalculated based on the output of the past period (Commission, ETS Summer University, 2015a). This procedure limits the amount of free allowances in the market, and as a result reduce the oversupply, and stabilize prices. This mechanism is called Market Stability Reserve (MSR) and not only aims to price stabilization but to the improvement of the EU ETS's resilience to future shocks.

As for auctions, the EU uses a single-round, sealed-bid and uniform price auction. At the single-round, bidders can bid only one time placing as many bids as they want. The sealed-bid means that all bids are secret and cannot be seen by other bidders. Hence, collusion is prevented. The bids are submitted via electronic platform. The term uniform price means that the entire volume of allowances at each auction is sold at the end at one final “clearing” price. Clearing means that only the bids at or above the price are filled (Commission, ETS

Summer University, 2015a). The platform collects all bids and rank them according to price. Starting from the highest bidder, all bidders receive their requested quantity until the available units. Those who do not receive have to buy allowances in the secondary market. Auctioning is governed by the Auctioning Regulation (EU Regulation No 1031/2010) which specifies the timing, administration and other aspects of how auctioning should take place to ensure an open, transparent, harmonized and non-discriminatory process (Commission, EU ETS Handbook, 2015b). The European Energy Exchange AG (EEX) is the transitional common auction platform for 25 Member States, and is also, separately, the opt-out common auction platform for Germany. The other auction platform is ICE Futures Europe (ICE), which is the opt-out auction platform for the UK (Commission, EU ETS Handbook, 2015b). The 88% of the total amount of allowances that can be auctioned is distributed to Member States based on their share of GHG emissions in phase I of the EU ETS, a further 10% of the auctioning rights are divided between Member States with low per capita income and the remaining 2% of auction rights are distributed to Member States which had already achieved a reduction of at least 20% in greenhouse gas emissions by 2005 (Commission, EU ETS Handbook, 2015b).

The Phase IV aims to increase the pace of emissions cut, to set up better-targeted carbon leakage rules, and to fund low-carbon innovation and energy sector modernization (Clara & Mayr, 2018). It foresees a continuation of the benchmarking allocation for carbon-leakage-exposed industry. It also introduces changes to the allocation methodology which apply to the calculation methodology in general, as well as to the specific benchmarking values (Duscha, 2018). Instead of collecting new data to calculate new benchmark curves, the proposal suggests a fixed updating factor of 1% p.a., only for sectors with significantly higher or lower efficiency improvements. Additionally, during Phase IV cancellation of allowances within the market stability reserve from 2024 onwards will be allowed (Duscha, 2018). As voted in 2015, the MSR should absorb annually 12% of the allowances in circulation, which will not be sufficient to absorb the surplus before the end of Phase IV (Vailles, et al., 2017).

#### **4.4. Revenues from auctions**

Auctioning is akin a tax as produces revenues for governments. EU ETS Directive states that “Member States shall determine the use of revenues generated from the auctioning of allowances”. Hence Member States are obliged to inform the Commission of how they use the revenues. Heads of State at the European Council in 2008, committed to use at least half of the auction revenues to reduce greenhouse gas emissions, mitigate and adapt to climate change (Commission, EU ETS Handbook, 2015b) forestry sequestration, carbon capture, low-emissions transport, and directed expenditures for low-income households (Council, 2003). Policy makers have to decide how to use them. They could serve to fund innovative emission reduction measures, lower other taxes in economy, add them to general revenues of the government or recycle them back to emitters (Commission, ETS Summer University, 2015a). Approximately 65% of climate and energy spending by member states in 2016 was related to energy efficiency improvements and investments in renewable energy sources. Most countries report spending on climate- and energy-related activities that is greater than 50 percent

of auction revenues. Only Italy and Romania reported investing less than 50 percent of their auction revenues in climate- and energy-related programs in 2016 (Löfgren, et al., 2018).

#### 4.5. Management of the EU-ETS

The two main aspects of EU – ETS management are the Union registry and the compliance cycle. EU ETS needs a system to accurately account for the issue, transfer, surrender and cancellation of allowances. Until 2012 this function was held by national registries. Then a single EU registry operated by EU Commission as an electronic accounting system that ensures the accurate accounting of EU allowances issued under the EU ETS and international credits. Records concern accounts of companies that hold allowances, transactions of allowances performed by account holders, annual verified CO<sub>2</sub> emissions from installations and annual reconciliation of allowances and verified emissions (Commission, ETS Summer University, 2015a). All transactions are checked, recorded and authorized by EU Transactional Log which acts as a guardian of the integrity of the Union registry and keeps a record of all transfers into and out of the accounts. It checks all registry transactions to make sure that they comply with the rules of the system. A legal or natural person must open an account in the Union registry before being able to participate in the EU. Depending on the nature of the account holder and his role or activities, there are the following account types are: operator holding accounts, aviation operator holding accounts, verifier accounts, person holding accounts, trading accounts and national accounts (Commission, EU ETS Handbook, 2015b).

As EU ETS operates, emitters must measure and report their emissions. In terms of transparency, these emissions must be verified by a regulator or an independent institution. This process is called MRV. The concept is that one ton emitted is equal to one ton reported which is equal to one allowance. Monitoring refers to the quantification of emissions from an entity. Reporting is the mandatory disclosure of monitored emissions data and verification is the confirmation of the report's correctness by an independent authority.

Every year, operators of installations hand in an annual emission report (AER) that is in line with the Monitoring and Reporting Regulation (MRR) to the Competent Authority. The AER is the key document that provides the amount of emitted greenhouse gases of the operator each year and must be verified by an independent accredited verifier. The accreditation of verifiers needs to be in line with the EU Accreditation and Verification regulation (Commission Regulation (EU) No 600/2012) (Commission, EU ETS Handbook, 2015b).

The steps in the annual EU ETS 'compliance cycle' are the followings. Firstly, operators submit a monitoring plan to the Competent Authority together with the GHG permit application. Then the Competent Authority checks and approves the monitoring plan. At the next step, operators monitor according to the approved plan and report their emissions during the calendar year. After that, they submit a verified annual GHG emissions report to the Competent Authority before 31 March of the year following the calendar year of monitoring. Then, allowances are surrendered before 30 April. Finally, the regulator authority commences annual verification process in June.

At compliance cycle, violations can be linked with the monitoring plan, the reviewing emission reports, the verification reports and the matching between allowances and reported emissions. In such cases there are sanctions and penalties. The firm has to pay 100€ per ton CO<sub>2</sub> which has not surrendered allowance for and must submit the outstanding allowances by purchasing them (Commission, ETS Summer University, 2015a).

## **5. Carbon price**

In an ETS, the carbon price is important, because if it is set too low, the companies may choose to simply buy what they need rather than reducing their emissions. Low price would also not encourage companies to replace high carbon-emission fuels, such as coal and oil, with natural gas or low-emission fuel (Chung, Jeong, & Young, 2018).

The factors that determine the carbon price have been studied. Analyses on the relationship between the allowance price and the energy market, showed that energy sources are the most important determinants of allowance price levels (Chung, Jeong, & Young, 2018). It has been proved that the stock prices affect the allowance price, but not vice versa (Lin & Kim, 2010). Moreover, oil price has a positive relationship with the allowance price. If the economy is in growth period, the demand for oil increases. As a result, CO<sub>2</sub> emissions increase. Thus, both the oil price and the allowance price increase. However, the coal and electricity prices have negative relationships with the allowance price (Lee & Park, 2014). Prices of Brent crude oil, natural gas, and coal have significant impacts on the carbon price (Tan & Wang, 2017). Hong et al found that Brent crude oil futures oil and natural gas are statistically significant in terms of forecasting CO<sub>2</sub> price movements, having a positive and a negative relationship with it, respectively (Hong, Jung, & Park, 2017). Furthermore, another study showed that in Phase III, the prices of oil, coal, natural gas, electricity, industrial production, economic sentiment, bank lending and high temperatures have a positive relationship with the EUA price (Chung, Jeong, & Young, 2018). Another paper provides novel evidence that oil shocks affect the carbon price. Positive oil demand shocks are shown to have an imminent and persistent positive effect on carbon emission price while oil supply disruption has a negative and less significant effect. These findings are economically significant as positive shocks on CO<sub>2</sub> emission allowance price trigger a small decrease on the aggregate stock return of the European equities markets (Tsouknidis, et al., 2019). The institutional information disclosure such as verified emissions announcements play also an important role in managing EU ETS; during the announcement periods, the trading volumes spike and the carbon prices fluctuate (Guo, et al., 2018).

The EUA price initially was unexpected high as it was supposed that there would be undersupply. When verified emissions published in 2006 the price sharply dropped. The market could be characterized long as supply exceeded demand. At those years, when allowances' banking was not allowed, the price crashed almost at 0€ in 2007. The impacts of overallocation are more substantial than those of the verified emissions announcements; massive selling behaviors near the end of Phase I could explain the structural breaks in the carbon prices (Guo, et al., 2018). The carbon price returns at Phase I were significantly negatively self-correlated, indicating that the fundamentals of supply and demand of carbon allowances had not been



disrupted. Trends of carbon prices are also significantly affected by the volumes of “trading with compliance purpose” (Guo, et al., 2018) which means purchasing allowances in order to avoid financial penalties due to the compliance cycle. At the same study, Guo et al., found that in Phase II the fundamentals of the carbon prices were disrupted, as the returns of carbon prices were white noise, indicating that Phase II exhibited a higher efficiency than Phase I. The trading pattern indicates that EU ETS is simply a compliance instrument in Phase I and has become more like a market in Phase II (Guo, et al., 2018).

Since late 2008 spot carbon allowances have been persistently cheap relative to futures prices which implied negative convenience yield. This may reflect a combination of the global financial crisis in late 2008 and the ongoing European banking crisis of 2010–2013 which constrained leverage and placed a high premium on liquidity. It may depict the lack of arbitrage due to financial constraints. Another factor should also be considered is the banking of allowances. As these prices reflect something real about the market’s view of the value of spot and futures positions, a negative convenience yield implies that the holder of a spot allowance expects to pay a price for holding the physical allowance. This would make sense if, for example, the holder of a physical allowance worried about changes to the rules of the system for example, a new regulation that taxed holders of physical allowances or disallowing the use of allowance vintages past a certain number of years (Bredin & Parsons, 2016).

## 6. Challenges

The implementation of carbon pricing initiatives often faces challenges concerning the capacity, the rules and the legal framework of operation, the infrastructure, the data accuracy and the social acceptance. To address these challenges, many initiatives implemented phases (World Bank, 2018). Another common challenge facing ETSs is market imbalance, due to oversupply. The EU ETS is introducing a market stability reserve (MSR) in 2019 following a long period of oversupply (World Bank, 2018). Other challenges refer to the effects of carbon pricing on firms’ competitiveness, the financial aspects of carbon pricing, the effects on shipping industry and the Brexit.

### 6.1 Competitiveness

Several studies have been conducted on the effects of EU ETS to firms’ competitiveness. The ex-post literature shows hardly any significant negative impacts on the competitiveness of regulated firms in a cross-sector comparison during Phase I and II (Joltreau & Sommerfeld, 2018). In a cap-and-trade system the transaction and MRV costs, increase the operational costs of firms and may lead to a loss of competitiveness. Regulated firms could lose market shares to non-regulated firms. Firms in the power, cement, iron and steel sectors, comparing ETS-regulated to non-ETS-regulated companies within each sector had no statistically significant negative effects on competitiveness. Also, there were not any significant impacts on employment in any of the studied sectors (Chan, Li, & Zhang, 2013).

Joltreau and Sommerfeld supported that this is derived from the fact that most emissions allowances in the EU ETS have been allocated for free by means of grandfathering, at least in the first two trading phases. Then there was overallocation as most firms have more allowances than they need and can therefore generate revenues from the sale of their allowance surplus. The oversupply of allowances in Phase III, is expected to lead to no significant negative effects on competitiveness. Lastly, firms in certain regulated sectors passed the costs of the EU ETS onto their customers. These findings showed that the EU ETS has effectively reduced GHG emissions in the regulated sectors without incurring substantial competitiveness effects (Joltreau & Sommerfeld, 2018).

## **6.2 Financial aspect**

An increasing number of organizations, businesses and investors are using internal carbon pricing as a tool to mitigate climate-related financial risks, discover new low carbon business opportunities and prepare for the transition to a low-carbon economy (World Bank, 2018).

However, new research by the Climate Disclosure Standards Board showed that there is still a clear gap between companies' awareness of climate related risks and actions for tackling them (CDP, 2018). A report which focuses on how the world's largest banks are looking at climate-related risks and opportunities of climate change, points toward a similar gap between awareness and action (Boston Common Asset Management, 2018). To support banks in implementing the Task Force on Climate-related Financial Disclosures recommendations, 16 banks and the United Nations Environment Program Finance Initiative announced a pilot initiative for developing analytical tools and indicators (World Bank, 2018).

### **6.2.1. Carbon Pricing Corridors**

Carbon Pricing Corridors initiative aims to support investors and businesses in their scenario analysis by identifying the carbon prices needed to achieve the ambitions of the Paris Agreement from the private-sector perspective. The framework helps companies to actively consider the GHG emissions covered, the level of influence in decisions and the future development of their internal carbon pricing approach. In terms of investors, it helps them to understand if the internal carbon pricing provides incentives for a company to manage its climate-related financial risks and opportunities. Finally, financial institutions use increasingly the internal carbon pricing to assess their investment portfolio, such as the World Bank and the International Finance Corporation (World Bank, 2018).

Many multilateral development banks (MDBs) have started to use internal carbon pricing to influence their investment decision-making and address climate risks. European Bank for Reconstruction and Development (EBRD) has publicly disclosed its carbon pricing methodology for coal-fired power generation projects. European Investment Bank (EIB) as part of its wider climate action strategy, has established internal carbon prices to 2050. The World Bank updated its approach in September 2017 to align the carbon prices used with the Paris-compatible prices from the High-Level Commission on Carbon Prices. All International

Development Association International Bank for Reconstruction and Development use a shadow price of carbon in economic analysis for financing investment projects in sectors that are subject to GHG accounting (World Bank, 2018).

### 6.3. Shipping

The maritime transport sector is essential for the European economy. About 79% of the EU's external freight trade, is delivered by shipping. Shipping is crucial regarding the supply of fuels for energy generation in Europe. Liquid bulk goods (liquefied gas, crude oil, oil products, and other liquid bulk goods), estimated up to 900.000 tons in 2015 (EEA,2018). In the EU-28 in 2015, almost 4 million tons of goods were handled in ports and more than 2 million vessels visited the main ports (Eurostat, 2017). Three European ports are among the world's 20 largest container ports: Rotterdam is 11th, Antwerp 14th and Hamburg 18th (World Shipping Council, 2017).

In 2017, merchant ships consisted up 21% of the European fleet (Eurostat, 2017) while in 2016, the EU-28 controlled 37% of the world's merchant fleet. Oil shipping accounts for about 30% of global maritime trade, but this proportion is predicted to fall until 2050 due to the changes in the energy mix (increased use of renewables) and energy efficiency measures in the EU (EEA, 2018).

The environmental impact of shipping industry is highly correlated with the energy sector. Nowadays, efforts to restrain the carbon footprint and improve the environmental performance of shipping industry take place. CO<sub>2</sub> emissions from shipping consist 2.5% of the global total. Since 1990, EU-28 emissions of GHGs from shipping have increased by 22%. In 2015, GHG emissions from the maritime sector comprised around 13% of the EU's total GHG emissions from the transport sector (EEA, 2018).

To remain below the 2°C objective of the Paris Agreement, recent research suggests that global emissions of the shipping sector in 2030 should be 13% lower than in 2005. In 2050 they should be 63% lower than in 2005 (EP, 2015). On April 2018, the International Maritime Organization's (IMO) adopted an initial strategy to reduce GHG emissions from international shipping in conjunction with the Paris Agreement temperature goals. The strategy stipulates a decrease of annual GHG emissions by at least 50% by 2050 compared to 2008, while at the same time pursuing efforts for full decarbonization. The strategy also indicates to decrease the sector's average carbon intensity by at least 40% by 2030, and 70% until 2050 (UNCTAD, 2018).

These targets require substantial technological innovation and the introduction of low and zero-carbon energy sources for international shipping. Market based mechanisms such as carbon pricing are among the possible mid-term measures which could be finalized and agreed upon between 2023 and 2030. MBMs provide an economic incentive for the maritime sector to reduce fuel consumption (CE Delft, DLR , & Fearnley Consultants, 2010). Implementing such a scheme can reduce emissions cost effectively, and could address environmental, social and economic concerns (Ben-Hakoun, Shechter , & Hayuth, 2016). Since January 2018, the EU has implemented monitoring measures that would facilitate a potential carbon pricing mechanism for

international maritime transport either globally or regionally (World Bank, 2018). The effects of the carbon price on shipping, depend on market structure, trade routes, and cargo type. The additional cost can be taken over by shippers in a demand-driven market, whereas this is less true in a supply-driven market (Kosmas & Acciario, 2017). The EU will also monitor accompanying measures to ensure that the sector duly contributes to the efforts needed to achieve the objectives agreed under the Paris Agreement (EEA, 2018).

An EU framework for MRV was developed through the MRV Shipping Regulation and adopted in April 2015 (EP, 2015). From January 2018, the regulation requires all ships over 5000 tons, that call at European Economic Area ports, to monitor their CO<sub>2</sub> emissions from and between EEA ports of call. It will also enable the EU to contribute to international developments, such as the requirements for a global data collection system for 2019 onwards (EEA, 2018).

At the EU level, the European Commission set out a strategy in 2013 to integrate the mitigation of maritime emissions into the EU's policy for reducing domestic GHG emissions (EC, 2013). The strategy consists of three steps:

- monitoring, reporting, and verification of CO<sub>2</sub> emissions from large ships;
- GHG reduction targets for the maritime transport sector; and
- further measures, including market-based measures, in the medium to longer term

In terms of timescales for key deliverables within the EU framework (EU, 2015), shipping companies, are responsible for the following:

- A monitoring plan will need to be submitted by 31 August 2017 to an accredited verifier.
- From 1 January 2018, companies have to monitor CO<sub>2</sub> emissions in accordance with Article 13. The reporting refers to vessels' CO<sub>2</sub> emissions and fuel consumption.
- From 2019, and by 30 April each year, a verified emissions report for each relevant ship should be submitted to the European Commission and to the authorities of the flag states concerned, by the companies.
- From 2019, and by 30 June each year, all relevant ships shall carry a document of compliance, which may be subject to inspections by Member States' authorities.

A ship that does not comply with EU legislation may be detained. After multiple detentions the ship is denied access to the concerned ports (PMoU, 2017). Lastly, in this direction, LNG is increasingly used as a marine fuel for shipping propulsion. By LNG, NO<sub>x</sub> emissions are reduced by 80-85%, sulphur content is very low, and CO<sub>2</sub> emissions are deteriorated by 20-30%. However, these reductions require expensive investment in technologies and the payback period is estimated between 2 and 4 years (EEA, 2017).

#### 6.4. Brexit

There is no guidance to whether and how to navigate proposals to depart from a trading scheme. This issue is now facing the UK, which has decided to terminate its membership of the European Union. UK does not need to leave the ETS when leaving the EU as Norway, Iceland and Liechtenstein are inside the ETS but outside the EU. But the UK would have to leave the ETS in order to completely withdraw from the jurisdiction of the European Court of Justice.

Exit from ETS would imply the loss of the UK demand for EU27 permits. As the UK's share of EU emission is projected to fall to 8.2-8.4% in 2020, this would lead to downward shock in the EUA prices (EEA, 2015). The average permit price dropped 20% after the referendum (ToI, 2017).

There are broadly two options for continued UK participation in the EU ETS. In theory, the first would be for ETS legislation to continue to apply to the UK, for example as a result of UK participation in the EEA. The second option would be for the UK to establish its own emissions trading scheme and seek agreement to link it to the EU ETS. There are precedents for this in the negotiations to link the EU ETS with Norway and Switzerland (Froggatt, Wright, & Lockwood, 2017).

#### 7. After 2020

The EU's targets for 2030, in terms of climate policy, are the followings: At least 40% cuts in greenhouse gas emissions from 1990 levels, at least 27% share for renewable energy, at least 27% improvement in energy efficiency (Barroso, 2014). In order to be achieved the overall greenhouse gas emissions reduction target for 2030, the sectors covered by the EU Emissions Trading System (EU ETS) must reduce their emissions by 43% compared to 2005 levels. In absolute numbers, 556 million tons CO<sub>2</sub> must be cut. The three key areas that are needed to make the system ready for the period 2021 – 2030 are mentioned in strengthening the system, ensuring robust safeguards against the risk of carbon leakage for industry, and providing funding instruments for low-carbon investments (Barroso, 2014). The main points of Directive 2018/410 are the followings.

The Market Stability Reserve (MSR) will be substantially reinforced which will begin to operate by January 2019 and aims to address the surplus of allowances and improve the system's resilience to shocks by adjusting the volume of allowances to be auctioned (Clara & Mayr, 2018).

The system of free allocation will be prolonged for another decade and has been revised to focus on sectors at the highest risk of relocating their production outside of the EU. These sectors will receive 100% of their allocation for free. For less exposed sectors, free allocation is foreseen to be phased out after 2026 from a maximum of 30% to 0 at the end of phase IV (European Parliament and Council, 2018).

Several low-carbon funding mechanisms will be set up to help energy-intensive industrial sectors and the power sector meet the innovation and investment challenges of the transition to a low-carbon economy. These include two new funds: The Innovation Fund which will support the demonstration of innovative technologies and breakthrough innovation in the industry as well as renewable energy and carbon capture and storage. The

Modernization Fund which will support investments in modernizing the power sector and wider energy systems, boosting energy efficiency, and facilitating a just transition in carbon-dependent regions in 10 lower-income Member States (European Parliament and Council, 2018).

After-2020, reforms include increasing the linear annual cap reduction from 1.74% to 2.2%, and a withholding annual rate of surplus allowances into the MSR to 24% until 2023. After 2023, the number of allowances held in the MSR will be limited to the previous year's auction volume and any allowances above this number will be invalidated. The benchmark levels will be updated every 5 years to take technological progress into account (World Bank, 2018).

## 8. Conclusion

In December 2017, under the Paris Agreement, parties representing 56% of global GHG emissions, stated that they intend to use of carbon pricing as a tool to meet their commitments. Carbon pricing is an effective and low cost mean of reducing CO<sub>2</sub> emissions and includes ETSS, offset mechanisms, carbon taxes, and RBCF. Carbon prices fluctuate from less than \$1/tCO<sub>2</sub> to \$139/tCO<sub>2</sub>. The implementation of carbon pricing initiatives faces challenges such as the market balance, the capacity, the rules and the legal framework of operation, the infrastructure, the data accuracy and the social acceptance. Carbon prices have a financial aspect as they are used like a tool to mitigate climate-related financial risks. Carbon Pricing Corridors initiative aims to support investors and businesses to identify the prices needed to achieve the ambitions of the Paris Agreement from the private-sector perspective. As for EU ETS a study showed that firms' competitiveness is not affected. Regarding shipping industry, IMO has adopted a strategy to reduce GHG emissions from international shipping by at least 50% by 2050 compared to 2008, while EU has implemented measures to facilitate a potential carbon pricing mechanism for international maritime. The main points after 2020 can be considered the continuation of auction, the free allocation in some cases and the new funding mechanism in order to be achieved the climate policy goals. The most recent developments concern the Paris Agreement and the cooperation between the affiliated parties and the financing of reduction of GHG emissions.

## References

- Agency, E. E. (2015). *Trends and projections in Europe 2015*. Luxemburg: EEA.
- Agency, E. E. (2018). *Aviation and shipping — impacts on Europe's environment: TERM 2017: Transport and Environment Reporting Mechanism (TERM) report*. Luxemburg: EEA.
- Barroso, J.-M. (2014). *Climate and energy priorities for Europe: the way forward*. Brussels: European Commission.
- Ben-Hakoun, E., Shechter, M. & Hayuth, Y. (2016). Economic evaluation of the environmental impact of shipping from the perspective of CO<sub>2</sub> emissions. *Journal of Shipping and Trade*, 1: 1-36.
- Bhattacharyya, S. (2011). *Energy Economics, concepts Issues, Markets and Governance*. London: Springer.
- Boston Common Asset Management (2018). *Banking on a Low-Carbon Future*. Boston Common Asset Management.
- Bredin, D. & Parsons, J. (2016). Why is Spot Carbon so Cheap and Future Carbon so Dear? The Term Structure of Carbon Prices. *The Energy Journal*, 37(3): 83-107.
- CDP (2018). *Ready or Not: Are Companies Prepared for the TCFD Recommendations*. CDSB and CDP .
- CE Delft, DLR & Fearnley Consultants. (2010). *A Global Maritime Emissions Trading System*. CE Delft.
- Chan, H.-S., Li, S. & Zhang , F. (2013). Firm competitiveness and the European Union emissions trading scheme. *Energy Policy*, 63: 1053-1064.

- Chung, C., Jeong, M. & Young, J. (2018). The Price Determinants of the EU Allowance in the EU Emissions Trading Scheme. *Sustainability*, 10(11): 01-29.
- Clara, S. D. & Mayr, K. (2018). *The EU ETS phase IV reform: implications for system functioning and for the carbon price signal*. Oxford: The Energy Institute for Energy Studies.
- Council & European Parliament (2003). Directive 2003/87/EC of the European Parliament and of the Council of 13 October 2003 establishing a scheme for greenhouse gas emission allowance trading within the Community and amending Council Directive 96/61/EC. Strasbourg: European Parliament and Council.
- Council & European Parliament (2018). DIRECTIVE (EU) 2018/410 OF THE EUROPEAN PARLIAMENT AND OF THE COUNCIL of 14 March 2018. Official Journal of the European Union.
- Cramton, P., MacKay, D., Ockenfels, A., & Stoft, S. (2017). *Global Carbon Pricing: The path to climate cooperation*. USA: MIT Press.
- Duscha, V. (2018). The EU ETS and Dynamic Allocation in Phase IV- An Ex-Ante Assessment. *Energies*, 11(2): 1-11.
- EEA (2017). *Monitoring progress of Europe's transport sector towards its environment, health and climate objectives*. Luxembourg: European Environmental Agency.
- Eichhammer, W., Friedrichsen, N., Healy, S., & Schum, K. (2018). Impacts of the Allocation Mechanism Under the Third Phase of the European Emission Trading Scheme. *Energies*, 11(6): 1-23.
- European Commission (2013). *European ports: an engine for growth*. Brussels: European Commission.
- European Commission (2015a). ETS Summer University. Available at: [https://ec.europa.eu/clima/policies/ets/ets-summer-university/sites/clima-ets-summer-university/files/Unit%204%20-%20International%20Climate%20Cooperation%20and%20the%20International%20Climate%20Market\\_0.swf](https://ec.europa.eu/clima/policies/ets/ets-summer-university/sites/clima-ets-summer-university/files/Unit%204%20-%20International%20Climate%20Cooperation%20and%20the%20International%20Climate%20Market_0.swf)
- European Commission (2015b). *EU ETS Handbook*. Brussels: European Union.
- European Parliament (2015). *Emission reduction targets for international aviation and shipping, Directorate General for Internal Policies*. Strasbourg: European Parliament.
- European Union (2015). Regulation (EU) 2015/757 of the European Parliament and of the Council of 29 April 2015 on the monitoring, reporting and verification of carbon dioxide emissions from maritime transport, and amending Directive 2009/16/EC (Text with EEA relevance). European Union.
- Eurostat (2017). <https://ec.europa.eu/eurostat/tgm/table.do?tab=table&plugin=1&language=en&pcode=ttr00012>
- Froggatt, A., Wright, G., & Lockwood, M. (2017). *Staying Connected, Key Elements for UK-EU27 Energy Cooperation After Brexit*. Exeter: Chatham House, The Royal Institute of International Affairs.
- Guo, J., Su, B., Yang, G., Feng, L., Liu, Y., & Gu, F. (2018). How Do Verified Emissions Announcements Affect the Comoves between Trading Behaviors and Carbon Prices? Evidence from EU ETS. *Sustainability*, 10(9): 1-17.
- Hong, K., Jung, H., & Park, M. (2017). Predicting European carbon emission price movements. *Carbon Management*, 8: 33-44.
- Joltreau, E. & Sommerfeld, K. (2018). Why does emissions trading under the EU Emissions Trading System (ETS) not affect firms' competitiveness? Empirical findings from the literature. *Climate Policy*, 19: 453-471.
- Kosmas, V., & Acciaro, M. (2017). Bunker levy schemes for greenhouse gas (GHG) emission reduction in international shipping. Transportation Research Part D. *Transport and Environment*, 57: 195-206.
- Krokida, S.-I., Lambertides, N., Savva, C., & Tsouknidis, D. (2019). The effects of oil price shocks on the prices of EU emission trading system and European stock returns. *The European Journal of Finance*, 26 (1): 1-13.
- Lee, E., & Park, M. (2014). A study on the price determinants of the emission allowance in the European market: Phase 1 and 2. *International Trade Economics*.
- Lin, Q. & Kim, T. (2010). A causality of the CO<sub>2</sub> price and the stock prices of steel corporations. *Korean Energy Economics*.
- Löfgren, Å., Burtraw, D., Wråke, M., & Malinovskaya, A. (2018). Distribution of Emissions Allowances and the Use of Auction Revenues in the European Union Emissions Trading System. *Review of Environmental Economics and Policy*, 12(2): 284-303.
- Mardas, D. (2013). *From the EEC to EU*. Thessaloniki: Zygos.
- OECD (2016). *Effective Carbon Rates: Pricing CO<sub>2</sub> through Taxes and Emissions Trading Systems*. Paris: OECD Publishing.
- PMoU (2017). Paris Memorandum of Understanding on Port State Control. Paris.
- Schleich, J., Rogge, K. & Betz, R. (2009). Incentives for energy efficiency in the EU Emissions Trading Scheme. *Energy Efficiency*, 2(1): 37-67.
- Tietenberg, T. & Lewis, L. (2012). *Environmental and Natural Resource Economics* (9th ed.). USA: Pearson.

- Tol, R. (2017). *Leaving an emissions trading scheme - insights from the United Kingdom*. Sussex: University of Sussex.
- UNCTAD (2018). *Review of maritime transport*. New York and Geneva: UNITED NATIONS CONFERENCE ON TRADE AND DEVELOPMENT.
- Vailles, C., Alberola, E., Cassisa, C., Bonnefous, J., Coussy, P., Marion, P., & Escagues, S. (2017). *EU ETS: last call before the doors close on the negotiations for the post-2020 reform*. France: Institute for climate economics.
- World Bank Group (2018). *State and trends of carbon pricing 2018*. Washington DC: World Bank.
- World Shipping Council. (2017). World Shipping Council. Available at: <http://www.worldshipping.org/about-the-industry/global-trade/top-50-world-container-ports>



### 4.3. Sustainable Development and the European Union: From Policy Making in the Field of Application

*Zoi Karanikola<sup>1</sup> & Georgios Panagiotopoulos<sup>2</sup>*

#### Abstract

The particular societal characteristics of our time, the rapid technological developments and the strong demographic changes create the need to formulate and implement supranational policies that aim at the well-being of citizens. The development of human beings and the maintenance of a decent standard of living is a key issue for the world community but also a continuing historical challenge. In this historic challenge, the UN has played a special role starting with the Universal Declaration of Human Rights in 1948. This text has been the basis for drafting many others, including the Millennium Development Goals (2000-2015) and the Agenda 2030 - Sustainable Development Goals (2015-2030). Sustainable development is a process of constant change and adaptation in order to meet the needs of both the present and future generation through a balanced and equitable pursuit of economic growth, environmental protection and social cohesion. The European Union (EU) has a long history of policymaking regarding the development and prosperity of societies. The Treaty of Maastricht (1992) has set the precondition for the EU to improve the cohesion of all European policies with a view to development, while the Treaty of Lisbon (2009) states that the Union should take into account that cohesion and Synergies of its policies that can affect developing countries. The present study, through the qualitative analysis of two EU texts (2016), the “Key European action supporting the 2030 Agenda and the Sustainable Development Goals” and the “Proposals for a new European Consensus on Development. Our World, our Dignity, our Future” comes to illustrate and explore the way the EU can contribute to achieving the Agenda's goals. The analysis of the text reveals that the policy-making, a key feature of which is cohesion, investment in education, the acquisition of right skills and the protection of human rights can contribute towards this direction.

**Keywords:** European Union, Agenda 2030, policies, education, human rights.

### Βιώσιμη Ανάπτυξη και Ευρωπαϊκή Ένωση: Από τη Χάραξη Πολιτικών στο Πεδίο της Εφαρμογής

*Ζωή Καρανικόλα & Γεώργιος Παναγιωτόπουλος*

#### Περίληψη

Τα ιδιαίτερα κοινωνικά χαρακτηριστικά της εποχής μας, οι ραγδαίες τεχνολογικές εξελίξεις και οι έντονες δημογραφικές αλλαγές δημιουργούν την ανάγκη χάραξης και υλοποίησης υπερεθνικών πολιτικών με κύριο στόχο την ευημερία των πολιτών. Η ανάπτυξη του ανθρώπου και η διασφάλιση ενός αξιοπρεπούς βιοτικού επιπέδου συνιστά βασικό ζητούμενο της παγκόσμιας κοινότητας αλλά και μια διαρκή ιστορική πρόκληση. Στην ιστορική αυτή πρόκληση ιδιαίτερο ρόλο παίζει ο ΟΗΕ με αφετηρία την Οικουμενική Διακήρυξη των Ανθρωπίνων Δικαιωμάτων του 1948. Το κείμενο αυτό αποτέλεσε τη βάση για τη σύνταξη πολλών άλλων, μεταξύ αυτών του προγράμματος «Στόχοι Ανάπτυξης Χιλιετίας» (2000-2015) και του προγράμματος «Ατζέντα 2030 - Στόχοι Βιώσιμης Ανάπτυξης» (2015-2030). Η βιώσιμη ανάπτυξη συνιστά μια διαδικασία συνεχούς αλλαγής και προσαρμογής με στόχο την ικανοποίηση των αναγκών του παρούσας γενιάς αλλά και των μελλοντικών μέσα από την ισόρροπη και ισότιμη επιδίωξη της οικονομικής ανάπτυξης, της περιβαλλοντικής προστασίας και της κοινωνικής συνοχής. Η Ευρωπαϊκή Ένωση (ΕΕ) έχει μια μακρά ιστορία στη χάραξη πολιτικών, αναφορικά με την ανάπτυξη και την ευημερία των κοινωνιών. Η Συνθήκη του Μάαστριχτ (1992) έθεσε ως προαπαιτούμενο για την ΕΕ τη βελτίωση της συνοχής όλων των ευρωπαϊκών πολιτικών με απώτερο στόχο την ανάπτυξη, ενώ στη Συνθήκη της Λισαβόνας

<sup>1</sup> University Of Patras, Greece, Email: zoekaranikola3@gmail.com

<sup>2</sup> University Of Patras, Greece

(2009) αναφέρεται ότι η Ένωση θα πρέπει να λάβει υπόψη της ότι η συνοχή και η συνέργεια των πολιτικών της μπορούν να επηρεάσουν τις αναπτυσσόμενες χώρες. Η παρούσα μελέτη, μέσα από την ποιοτική ανάλυση ενός κειμένου της ΕΕ (2016), το «Key European action supporting the 2030 Agenda and the Sustainable Development Goals» έρχεται να αποτυπώσει και να ερευνήσει τον τρόπο με τον οποίο δύναται να συμβάλει η ΕΕ στην επίτευξη των στόχων της Ατζέντας. Μέσα από την ανάλυση του κειμένου διαφαίνεται ότι η χάραξη πολιτικών, η επένδυση στην εκπαίδευση και στις κατάλληλες δεξιότητες καθώς και η προάσπιση των ανθρωπίνων δικαιωμάτων μπορούν να συμβάλλουν προς αυτή την κατεύθυνση.

**Λέξεις κλειδιά:** Ευρωπαϊκή Ένωση, Ατζέντα 2030, πολιτικές, εκπαίδευση, ανθρώπινα δικαιώματα

### **Εισαγωγή: Ανάπτυξη και βιώσιμη ανάπτυξη**

Μέχρι τα μέσα του 20<sup>ου</sup> αιώνα, η οικονομική ανάπτυξη θεωρούταν πρωταρχικός στόχος της εκάστοτε εθνικής πολιτικής και σημαντικός δείκτης προόδου, ενώ από τη δεκαετία του 1970 και μετά, η ανάπτυξη συνιστά διαδικασία οικονομικού και κοινωνικού μετασχηματισμού καθώς και διεύρυνσης των ανθρωπίνων επιλογών. Επιπρόσθετα, αφορά στη δυνατότητα των ατόμων να μπορούν να επιλύουν προβλήματα και να επηρεάζουν τις διαδικασίες που διαμορφώνουν τις ζωές τους (Παναγιωτόπουλος, Καρανικόλα, & Ανδρεαδάκης, 2019).

Από τη δεκαετία του 1990 και μετά τίθενται οι αρχές της βιώσιμης ανάπτυξης στη Διεθνή Συνδιάσκεψη του Ρίο. Η βιωσιμότητα συνιστά έννοια πολυσήμαντη και πολυδιάστατη, ενώ υπάρχουν διάφορες θεωρητικές προσεγγίσεις ως προς την ερμηνεία της. Η επικρατέστερη αναφέρεται στην ισότιμη και ισόρροπη ανάπτυξη τριών πυλώνων: της οικονομίας, της κοινωνίας και του περιβάλλοντος. Επιπρόσθετα, παρέχει ένα πλαίσιο για την ενσωμάτωση των περιβαλλοντικών πολιτικών και των αναπτυξιακών στρατηγικών (United Nations, 1987), ενώ συμπληρωματικά, ως προς αυτή τη θεώρηση, υπάρχουν διάφορα είδη κεφαλαίου, το κοινωνικό, το φυσικό και το ανθρωπογενές. Σύμφωνα με τον ορισμό της βιώσιμης ανάπτυξης, τα χαρακτηριστικά των φυσικών πόρων είναι μοναδικά και συνεπώς το φυσικό κεφάλαιο δεν μπορεί σε καμία περίπτωση να αντικατασταθεί από το ανθρωπογενές (Stoddart, 2011).

Οι ανθρώπινες ελευθερίες και δυνατότητες βρίσκονται στο προσκήνιο με μια διάσταση οικουμενική. Έτσι, κάθε ανθρώπινη ζωή είναι μοναδική και δικαιούται να αξιοποιήσει στο έπακρο το δυναμικό της, μέσα σε συνθήκες ευημερίας και αυτονομίας. Σύμφωνα με τον Δείκτη Ανθρώπινης Ανάπτυξης, υπάρχουν τρεις βασικές διαστάσεις που άμεσα επηρεάζουν την ανθρώπινη ανάπτυξη. Αρχικά το προσδόκιμο ζωής που συνδέεται με μια μακρά και υγιή ζωή, τα έτη σχολικής φοίτησης που επηρεάζουν την ικανότητα απόκτησης γνώσεων και δεξιοτήτων και τέλος το κατά κεφαλήν ακαθάριστο εθνικό εισόδημα που αντικατοπτρίζει την ικανότητα επίτευξης ενός αξιοπρεπούς βιοτικού επιπέδου (Human Development Report, 2016: 3).

Όμως, υπάρχουν και οι παράγοντες εκείνοι που έμμεσα συμβάλλουν στη δημιουργία συνθηκών ανάπτυξης. Τέτοιοι παράγοντες είναι η ενεργός συμμετοχή στην κοινοτική και πολιτική ζωή, η περιβαλλοντική βιωσιμότητα, η ισότητα των δύο φύλων, η προάσπιση και διασφάλιση των ανθρωπίνων δικαιωμάτων, η

συμμετοχή στον δημόσιο διάλογο, η φωνή, η ατομική και συλλογική δράση (Παναγιωτόπουλος, Καρανικόλα, & Ανδρεαδάκης, 2019).

Ωστόσο, η παγκόσμια διάσταση της ανάπτυξης προϋποθέτει την υπέρβαση σημαντικών εμποδίων, τα οποία ενίοτε συνδέονται με τα οικονομικά, γεωγραφικά, κοινωνικά και πολιτικά χαρακτηριστικά των ατόμων. Συχνά, ορισμένα εμπόδια είναι βαθιά ενσωματωμένα στις ταυτότητες και σχέσεις των ανθρώπων και εντοπίζονται στις διακρίσεις, στις αδικίες, στα πρότυπα αποκλεισμού, στις άνισες ευκαιρίες πρόσβασης σε διάφορα πεδία, όπως αυτό της εκπαίδευσης, στη μισαλλοδοξία, στη βία, στις αξίες και στους κανόνες (Human Development Report, 2016).

### **Βιώσιμη ανάπτυξη και διεθνείς οργανισμοί**

Η ανάπτυξη του ανθρώπου αποτελεί βασικό ζητούμενο της διεθνούς κοινότητας και μια ιστορική πρόκληση των υπερεθνικών οργανισμών. Έτσι, ο Οργανισμός των Ηνωμένων Εθνών (ΟΗΕ), με το Πρόγραμμά του «Αναπτυξιακοί Στόχοι Χιλιετίας» (Millennium Development Goals, 2000-2015) θέτει οκτώ στόχους ανάπτυξης για τη χιλιετία, τους οποίους τα 191 κράτη-μέλη του ΟΗΕ συμφωνούν να επιδιώξουν μέχρι το 2015. Οι στόχοι αυτοί αφορούν στην εξάλειψη της ακραίας φτώχειας και της πείνας, την επίτευξη καθολικής πρωτοβάθμιας εκπαίδευσης, την προώθηση της ισότητας των φύλων και της ενδυνάμωσης της γυναίκας, τη μείωση της παιδικής θνησιμότητας, τη βελτίωση της υγείας των μητέρων, την καταπολέμηση του HIV/AIDS, της ελονοσίας και άλλων ασθενειών, τη διασφάλιση της περιβαλλοντικής βιωσιμότητας και τέλος την ανάπτυξη ενός παγκόσμιου δικτύου ανάπτυξης. Οι στόχοι αυτοί είναι αλληλοεξαρτώμενοι και αλληλοσυμπληρούμενοι (WHO, 2018).

Εξέλιξη αυτού του προγράμματος αποτελεί το Πρόγραμμα «Ατζέντα, 2030 – Στόχοι Βιώσιμης Ανάπτυξης» (Sustainable Development Goals, 2015-2030), το οποίο συνιστά «ένα σχέδιο δράσης για τους ανθρώπους, τον πλανήτη και την ευημερία» (UN, 2015: 1), ενώ περιλαμβάνει δεκαεπτά οικουμενικούς και αδιαίρετους στόχους και 169 επιμέρους στόχους. Βασικοί άξονές του αποτελούν η εξάλειψη της φτώχειας, η γενίκευση της εκπαίδευσης σε όλες τις βαθμίδες, η ισότητα των φύλων, η διασφάλιση της υγείας και της ευημερίας, η πρόσβαση σε εναλλακτικές μορφές ενέργειας, η προστασία του περιβάλλοντος και ο σεβασμός στα θεμελιώδη ανθρώπινα δικαιώματα (UN, 2015: 1).

Η Ευρωπαϊκή Ένωση έχει μακρόχρονη πορεία στη χάραξη πολιτικών αναφορικά με την ανάπτυξη των κοινωνιών. Συγκεκριμένα, με τη Συνθήκη του Μάαστριχτ (1992) ενισχύεται η αρχή της επικουρικότητας, σύμφωνα με την οποία οι αποφάσεις θα λαμβάνονται πιο κοντά στους πολίτες και η αρχή της οικονομικής και κοινωνικής συνοχής, με στόχο την προαγωγή ενός υψηλού βαθμού σύγκλισης των οικονομικών επιδόσεων των κρατών μελών. Επίσης, εισάγεται νέο κεφάλαιο, το οποίο αναφέρεται στην παιδεία, την επαγγελματική εκπαίδευση, την πολιτισμική και γλωσσική πολυμορφία. Αργότερα, με τη Συνθήκη του Άμστερνταμ (1997) εισέρχονται αλλαγές στη θεσμική δομή της Ένωσης, στις σχέσεις Ένωσης – Πολιτών (επιδίωξη ενός υψηλού

επιπέδου απασχόλησης, καταπολέμηση διακρίσεων βάσει φύλου, θρησκείας, φυλής, αναπηρίας, ηλικίας, εθνικής καταγωγής, σεξουαλικής προτίμησης), στην κοινή εξωτερική πολιτική και πολιτική ασφάλειας και στη συνεργασία στους τομείς της δικαιοσύνης και των εσωτερικών υποθέσεων. Ακολουθεί η Συνθήκη της Νίκαιας (2003) και η Συνθήκη της Λισαβόνας (2007), σύμφωνα με την οποία μεταρρυθμίζονται τα θεσμικά όργανα της Ένωσης, βελτιώνεται η διαδικασία λήψης αποφάσεων, ενισχύεται η εξωτερική πολιτική, απλουστεύονται οι νομοθετικές διαδικασίες, ενισχύεται η φωνή των πολιτών (Μυλωνόπουλος & Μοίρα, 2011).

Αναφορικά με τους στόχους του Προγράμματος «Αναπτυξιακοί Στόχοι Χιλιετίας» (Millennium Development Goals, 2000-2015), η Συμβολή της Ευρώπης δεν ήταν ασήμαντη. Μεταξύ άλλων, το 2010 δρομολόγησε 68 έργα σε 46 χώρες, δίνοντας έμφαση στην καταπολέμηση της πείνας και της παιδικής θνησιμότητας, στη βελτίωση της μητρικής υγείας, στην παροχή νερού και αποχετευτικών συστημάτων, ενώ η δαπάνη για τα έργα αυτά ανέρχεται στο ένα δισεκατομμύριο ευρώ (European Commission, 2015: 6). Επιπρόσθετα, σε παγκόσμιο επίπεδο, η Ευρωπαϊκή Ένωση υποστηρίζει περισσότερες από 60 χώρες στην προσπάθειά τους να βελτιώσουν την ποιότητα των τροφίμων, της διατροφής και της γεωργίας (European Commission, 2015: 8). Τέλος, χρηματοδοτεί προγράμματα επαγγελματικής εκπαίδευσης και κατάρτισης συνολικού ύψους άνω των δύο δισεκατομμυρίων ευρώ το 2007, ενώ βάζει υψηλότερους στόχους για την περίοδο 2014-2020 (European Commission, 2015: 9).

Η ΕΕ και τα κράτη μέλη της καλούνται να παίξουν μείζονος σημασίας ρόλο στην εφαρμογή της Ατζέντας και να συμμορφωθούν με τις δεσμεύσεις που απορρέουν από το «Σύμφωνο Ανάπτυξης της Ευρώπης» (European Commission, 2005), το οποίο ορίζει τις κοινές αξίες, βάσει των οποίων θα πρέπει να διαμορφώνονται οι πολιτικές ανάπτυξης (Παναγιωτόπουλος, Καρανικόλα, & Ανδρεαδάκης, 2019).

### **Υλικό υπό έρευνα και παρουσίαση μεθοδολογικού εργαλείου**

Το ερευνητικό ερώτημα της παρούσας εργασίας αφορά στον τρόπο με τον οποίο η ΕΕ προτίθεται να συμβάλλει στην επίτευξη των στόχων της ατζέντας που αφορούν στη βιώσιμη ανάπτυξη. Απάντηση σε αυτό το ερώτημα επιδιώκεται να δοθεί μέσα από την ποιοτική ανάλυση ενός κειμένου της ΕΕ. Πρόκειται για το κείμενο «Key European action supporting the 2030 Agenda and the Sustainable Development Goals» (European Commission, 2016), το οποίο περιγράφει τις πολιτικές, τους τρόπους χρηματοδότησης και τις δράσεις τις οποίες προτίθεται να αναλάβει η ΕΕ προς αυτή την κατεύθυνση. Η σύνταξη του κειμένου αυτού συνδέεται και συμπληρώνεται από ένα δεύτερο κείμενο της ΕΕ, το «Proposals for a new European Consensus on Development. Our World, our Dignity, our Future» είναι επίσης το τελικό κείμενο της Ευρωπαϊκής Επιτροπής (European Commission, 2016b), το οποίο συνιστά το νέο Ευρωπαϊκό Σύμφωνο για την ανάπτυξη. Στο κείμενο αυτό γίνεται αναφορά στον τρόπο ανταπόκρισης της ΕΕ στο πρόγραμμα της ατζέντας, στο πλαίσιο δράσης της αλλά και στην ανάγκη ανάπτυξης πολιτικών συνεργασίας και συνοχής.

Η ανάλυση του προαναφερθέντος κειμένου έγινε με το εργαλείο των θεματικών δικτύων. Πρόκειται για μια επαγωγική αναλυτική διαδικασία που επιτρέπει τη βαθιά και πλούσια εξερεύνηση τόσο των επιφανειακών όσο και βαθύτερων δομών του κειμένου (Braun & Clarke, 2006; Gibbs, 2007). Ο Boyatzis (1998) αναφέρει ότι η θεματική ανάλυση συνιστά μια διαδικασία κωδικοποίησης ποιοτικών πληροφοριών. Επιπλέον, παρέχει μια πλούσια, λεπτομερή και σύνθετη έκθεση των δεδομένων, ερμηνεύοντας ταυτόχρονα διάφορες πτυχές των θεμάτων (Braun & Clarke, 2006).

Η συγκεκριμένη μεθοδολογία περιλαμβάνει τρεις τάξεις θεμάτων: το βασικό (basic theme), το οργανωτικό (organizing) και το ολικό (global). Το βασικό αφορά στα πιο απλά χαρακτηριστικά των δεδομένων του κειμένου και από μόνο του δίνει λίγες πληροφορίες για το σύνολο του κειμένου. Προκειμένου να επιτευχθεί βαθύτερη κατανόηση του περιεχομένου του κειμένου, θα πρέπει να το διαβάσουμε σε σχέση με τα άλλα βασικά θέματα και όλα μαζί συνθέτουν τη δεύτερη τάξη θεμάτων, το οργανωτικό θέμα (organizing theme). Το οργανωτικό θέμα είναι μεσαίας τάξης θέμα, το οποίο οργανώνει τα βασικά θέματα σε ομάδες παρόμοιων θεμάτων. Ο ρόλος του επίσης είναι να επαυξήσει την έννοια και τη σημασία ενός ευρύτερου θέματος, το οποίο ενώνει αρκετά οργανωτικά θέματα. Με τον τρόπο αυτό δημιουργείται το τρίτο θέμα, το ολικό (Global Theme). Το ολικό θέμα είναι υπερτασσόμενο (super-ordinate) θέμα και περιλαμβάνει τη βασική ιδέα του κειμένου ως συνόλου (Attride – Stirling, 2001).

Στην παρούσα έρευνα το ζητούμενο είναι η ανάπτυξη (ολικό θέμα), η οποία μπορεί να επιτευχθεί με τη χάραξη κατάλληλων πολιτικών (οργανωτικό θέμα), την επένδυση στην εκπαίδευση (οργανωτικό θέμα), την απόκτηση κατάλληλων δεξιοτήτων (οργανωτικό θέμα), την προάσπιση των ανθρωπίνων δικαιωμάτων και των κοινωνικών αξιών (οργανωτικό θέμα).

### **Συγκρότηση και περιγραφή θεματικών δικτύων**

Η ΕΕ, ως προς το θεματικό δίκτυο των πολιτικών έχει προβεί στη χάραξη εσωτερικών (ευρωπαϊκών) και εξωτερικών (διεθνών) πολιτικών και στον σχεδιασμό αντίστοιχων προγραμμάτων. Διακρίνονται για τον μακροχρόνιο ορίζοντα και τον δεσμευτικό χαρακτήρα τους, ενώ προϋποθέτουν συγκεκριμένες δράσεις σε τοπικό, εθνικό, ευρωπαϊκό και παγκόσμιο επίπεδο. Επιπρόσθετα, οι πολιτικές χρειάζεται να εκσυγχρονίζονται, να ελέγχονται, να αξιολογούνται ως προς την εφαρμογή τους και να έχουν ένα συγκεκριμένο πλαίσιο λειτουργίας και κατανομής των διατιθέμενων πόρων.

Μία από τις προτεραιότητες της εξωτερικής δράσης της ΕΕ είναι η προώθηση της βιώσιμης οικονομικής, κοινωνικής και περιβαλλοντικής ανάπτυξης στις αναπτυσσόμενες χώρες με πρωταρχικό στόχο την εξάλειψη της φτώχειας. Ο στόχος αυτός δύναται να επιτευχθεί μέσω της μακροοικονομικής σταθεροποίησης, της βελτιωμένης διαχείρισης των δημόσιων πόρων και των εμπορικών πλαισίων, της ενίσχυσης των δικτύων μεταφορών και της αύξησης των δημόσιων δαπανών στους κοινωνικούς τομείς (European Commission,

2016a: 7). Η Ευρώπη έχει ανοίξει τις αγορές της σε εισαγωγές από φτωχότερες χώρες (European Commission, 2016: 8).

Έμφαση, δε, δίδεται στην ανάπτυξη της γεωργίας και της αλιείας (Common Agricultural Policy, Common Fisheries Policy) καθώς θεωρείται ότι μπορούν να συμβάλλουν σημαντικά στη μείωση της φτώχειας, της πείνας και της ανεργίας (European Commission, 2016a: 8). Ιδιαίτερα στηρίζονται οι μικρομεσαίοι αγρότες μέσα από την προώθηση βιώσιμων γεωργικών πρακτικών και την καταπολέμηση του υποσιτισμού (European Commission, 2016: 10).

Επιπρόσθετα, η ΕΕ υιοθετεί την πολιτική της καινοτομίας. Έτσι, ιδρύθηκε μια Ευρωπαϊκή Εταιρεία Καινοτομίας για την αγροτική παραγωγή και τη βιωσιμότητα. Επίσης, το πρόγραμμα Horizon 2020, επενδύει σε έργα που σχετίζονται με τις κοινωνικές προκλήσεις της ασφάλειας των τροφίμων και της διατροφής. Προς αυτή την κατεύθυνση ένα κοινό πρόγραμμα έρευνας και καινοτομίας είναι το FOOD 2030 (European Commission, 2016a: 11).

Μεγάλη είναι, σύμφωνα με το κείμενο, και η συμβολή της «Ευρωπαϊκής Πολιτικής Συνοχής» (Europe Cohesion Policy), η οποία αποτελεί τη βασική επενδυτική πολιτική της Ευρώπης, στόχος της οποίας είναι η επίτευξη της οικονομικής, κοινωνικής και εδαφικής συνοχής μέσα από τη μείωση των ανισοτήτων από περιοχή σε περιοχή. Σημαντικά όργανα και δομές χρηματοδότησης των ευρωπαϊκών προγραμμάτων και δράσεων είναι:

I. Το Ευρωπαϊκό Ταμείο Διαρθρωτικών Επενδύσεων (European Structural Investment Fund), II. Το Πρόγραμμα Απασχόλησης και Κοινωνικής Καινοτομίας (Employment and Social Innovation Program), III. Το Ταμείο για την Παροχή Ευρωπαϊκής Βοήθειας στους πιο Άπορους (Fund for European Aid to the Most Deprived), IV. Το Ευρωπαϊκό Πρόγραμμα Αλληλεγγύης (European Solidarity Corps), V. Το Πρόγραμμα Ορίζοντας 2020 (Horizon 2020), VI. Το Πρόγραμμα της Ένωσης για την Εκπαίδευση, την Κατάρτιση, τη Νεολαία και τον Αθλητισμό (Union Program for Education, Training, Youth and Sport), VII. Το Ευρωπαϊκό Ινστιτούτο Καινοτομίας και Τεχνολογίας (European Institute of Innovation and Technology), VIII. Το πρόγραμμα «Erasmus Plus» (European Commission, 2016a: 19-24).

Το δεύτερο θεματικό δίκτυο αφορά στη μάθηση και στις δεξιότητες που θα οδηγήσουν στην εξέλιξη και ανάπτυξη του ατόμου. Σύμφωνα με τις πολιτικές της ΕΕ, οι τεχνικές και οι μέθοδοι εκπαίδευσης θα βασίζονται στις αρχές της δια βίου μάθησης, ενώ θα διεξάγονται σεμινάρια, εργαστήρια και σχέδια επίδειξης. Η κινητικότητα των ατόμων, η διάχυση καλών πρακτικών, η συνεργασία και η συνοχή διάφορων κοινωνικών εταίρων θα συμβάλει σε καλύτερα αποτελέσματα. Μεγάλη έμφαση δίνεται στην ανάλυση δεξιοτήτων που απαιτεί κάθε ομάδα στόχος προκειμένου να οδηγηθεί στη μέγιστη δυνατή ανάπτυξη και αποδοτικότητα. Οι ψηφιακές δεξιότητες και η προώθηση περιβαλλόντων που θα υποστηρίξουν την ψηφιακή οικονομία, δράση και καινοτομία είναι ύψιστης προτεραιότητας.

Η νέα Ατζέντα της ΕΕ για τις δεξιότητες περιλαμβάνει σημαντικές δράσεις προκειμένου να διασφαλιστεί η κατάλληλη εκπαίδευση και υποστήριξη των ατόμων. Η παροχή επαγγελματικής εκπαίδευσης και κατάρτισης και η συνεχής αναβάθμιση των δεξιοτήτων αποτελούν βασικές προτεραιότητες, ενώ ταυτόχρονα η ΕΕ καλεί πολλούς διαφορετικούς εταίρους (από τον ιδιωτικό και δημόσιο χώρο) να συνεργαστούν προκειμένου οι δεξιότητες αυτές να καταστούν πιο ορατές και συγκρίσιμες (European Commission, 2016a).

Αναφορικά με την εκπαίδευση, η ΕΕ διαθέτει μια ενεργό πολιτική συνεργασίας με στόχο την ανάπτυξη, τον εκσυγχρονισμό και τη διεθνοποίηση της εκπαίδευσης και της κατάρτισης τόσο στην Ευρώπη όσο και πέραν της Ευρώπης με την προώθηση της μάθησης από ομότιμους, τη σύγκριση των εκπαιδευτικών συστημάτων σε παγκόσμιο επίπεδο, την κινητικότητα και την ανταλλαγή φοιτητών, εκπαιδευτικών, εκπαιδευτών και προσωπικού, τη χορήγηση υποτροφιών σε ευπαθείς και ευάλωτες ομάδες (European Commission, 2016a: 18).

Τα προγράμματα Erasmus και διαπανεπιστημιακής συνεργασίας είναι ένα ανεκτίμητο μέσο για την καθιέρωση διαρκούς ακαδημαϊκής και επαγγελματικής κατάρτισης και την εγκαθίδρυση σταθερών και ισχυρών ακαδημαϊκών δεσμών. Τέλος, βασικοί άξονες των εκπαιδευτικών πολιτικών συνιστούν θέματα, όπως η πρόωγη εγκατάλειψη του σχολείου, η τριτοβάθμια εκπαίδευση, η παιδική εκπαίδευση και φροντίδα, οι ελλείψεις στην ανάγνωση, τα μαθηματικά και τις φυσικές επιστήμες, το ποσοστό απασχόλησης των πτυχιούχων, η συμμετοχή των ενηλίκων στη μάθηση. Από το τέλος του 2015 και μετά δίνεται μεγαλύτερη προσοχή στη συμπεριληπτική εκπαίδευση, στην ισότητα, στην καταπολέμηση των διακρίσεων και του αποκλεισμού, στην προαγωγή της ιδιότητας του πολίτη (European Commission, 2016a: 18).

Η ΕΕ ακολουθεί μια προσέγγιση βασισμένη στη δόμηση ενός πυλώνα κοινωνικών αξιών και δικαιωμάτων, τα οποία θα αποτελέσουν πυξίδα για τη βελτίωση, την εξέλιξη και την ανάπτυξη των ατόμων και των κοινωνιών (τρίτο θεματικό δίκτυο). Επικεντρώνεται στις λιγότερο αναπτυγμένες χώρες και χώρες με χαμηλότερο εισόδημα (European Commission, 2016a: 7). Η ισότητα, η ισότιμη πρόσβαση στην εκπαίδευση και στην αγορά εργασίας, η κοινωνική προστασία, η εξάλειψη διακρίσεων, η ενδυνάμωση των γυναικών, η προώθηση της ιδιότητας του πολίτη, ο σεβασμός στην ετερότητα, η αξιοπρέπεια, η αλληλεγγύη, η κοινωνική δικαιοσύνη, ο κοινωνικός διάλογος συνιστούν μερικές από τις βασικές διαστάσεις της φιλοσοφίας των πολιτικών δράσεων της ΕΕ σχετικά με την επίτευξη των στόχων της Ατζέντας (European Commission, 2016a: 16, 18, 26, 29). Προς αυτή την κατεύθυνση ετοιμάζει μια ετήσια έκθεση προκειμένου να παρακολουθείται η πρόοδος σε ζητήματα ισότητας των φύλων σε επίπεδο ΕΕ (European Commission, 2016a: 22). Επιπρόσθετα, η ανθρωπιστική βοήθεια της ΕΕ παρέχει υποστήριξη και εμπειρογνομosύνη σε θέματα που αφορούν στην αξιοπρεπή και χωρίς εκμετάλλευση εργασία των προσφύγων και των ευπαθών ομάδων (European Commission, 2016a: 30).

### **Συζήτηση επί των αποτελεσμάτων**

Τα ερευνητικά αποτελέσματα, τα οποία προήλθαν μέσω της ανάλυσης περιεχομένου, έδειξαν ότι μια βασική διάσταση της ανάπτυξης είναι η χάραξη και εφαρμογή κοινών, συνεκτικών και οικουμενικών πολιτικών, οι οποίες είναι, ωστόσο, προσαρμοσμένες στα δεδομένα και τις ιδιαιτερότητες του κάθε κράτους. Τα

χαρακτηριστικών αυτά των πολιτικών διαφαίνονται και στα επίσημα κείμενα της UNESCO. Συγκεκριμένα, στο κείμενο «Recommendation on Adult Learning & Education» (UNESCO, 2015) τονίζεται η ανάγκη οι πολιτικές να είναι συμπεριληπτικές, περιεκτικές, ολιστικές, ενώ επιπρόσθετα καθοδηγούν τη μάθηση σε ποικίλα πεδία: οικονομικό, πολιτικό, κοινωνικό, πολιτισμικό, τεχνολογικό, περιβαλλοντικό. Απευθύνονται ισότιμα στις ανάγκες όλων των ενηλίκων ανεξαρτήτως ιδιαιτεροτήτων και βασίζονται στη διεπιστημονική γνώση και εμπειρία.

Μέσα από την ανάλυση του υπό έρευνα υλικού διαπιστώνεται επίσης πως η ΕΕ μέσα από τις πολιτικές της στοχεύει πρωτίστως στις ευπαθείς κοινωνικές ομάδες αναπτυσσόμενων χωρών, οπότε προχωράμε στην επόμενη διάσταση της ανάπτυξης, η οποία αφορά στη μάθηση και στις δεξιότητες. Διαφαίνεται έντονα η ανάγκη καλλιέργειας σωστών και κατάλληλων δεξιοτήτων προκειμένου να ενδυναμωθεί το ανθρώπινο δυναμικό και ιδιαίτερα αυτό που ανήκει σε ευάλωτες ομάδες. Η ανάγκη αυτή υποστηρίζεται επίσης από τον ΟΟΣΑ και την UNESCO, δεδομένου πως η επαγγελματική επιβίωση, σε μια εποχή έντονου ανταγωνισμού, ραγδαίων δημογραφικών αλλαγών και τεχνολογικών εξελίξεων, εξαρτάται από την ποιότητα και το είδος των προσωπικών δεξιοτήτων (Karaniola, & Panagiotopoulos, 2018).

Τέλος, η πλειονότητα των πολιτικών της ΕΕ βασίζεται σε έναν πυλώνα βασικών και θεμελιωδών δικαιωμάτων. Τα δικαιώματα αυτά έχουν την απαρχή τους στην Οικουμενική Διακήρυξη των Δικαιωμάτων του Ανθρώπου του ΟΗΕ κι έκτοτε περιγράφονται και προωθούνται συλλογικά από τους διεθνείς οργανισμούς.

Αξίζει να σημειωθεί ότι η παρούσα έρευνα περιορίζεται στη διερεύνηση του τρόπου ανάπτυξης, όπως αυτή προκύπτει από το περιεχόμενο των συγκεκριμένων κειμένων. Ωστόσο, πόσο εύκολη και εφικτή είναι η εφαρμογή και η υλοποίηση όλων αυτών των δράσεων, όταν μάλιστα κάποιος αναλογιστεί πως, ενώ στην Ευρώπη παρατηρείται οικονομική, κοινωνική, περιβαλλοντική ανάπτυξη και βελτίωση της παγκόσμιας συνεργασίας, ταυτόχρονα παρατηρείται έντονη οικονομική κρίση. Συνεπώς, είναι χρήσιμο να διερευνάται σε ένα συνεχές επίπεδο τι πραγματικά υλοποιείται και πώς μεταφέρονται οι πολιτικές σε πράξη.

### **Βιβλιογραφικές αναφορές**

- Attride-Stirling, J. (2001). Thematic Networks: an Analytic Tool for Qualitative Research. *Qualitative Research Copyright, 1* (3): 385-405.
- Boyatzis, R. E. (1998). *Transforming Qualitative Information: Thematic Analysis and Code Development*. London & New Delhi: Thousand Oaks, SAGE Publications.
- Braun, V. & Clarke, V. (2006). Using thematic analysis in psychology. *Qualitative Research in Psychology, 3*: 77-101.
- European Commission. (2015). The EU's Contribution to the Millennium Development Goals. Key results from European Commission Programmes. Available at: [file:///C:/Users/EliteBook/Downloads/brochure-mdg-2015\\_en.pdf](file:///C:/Users/EliteBook/Downloads/brochure-mdg-2015_en.pdf)
- European Commission. (2016). Proposals for a new European Consensus on Development. Our World, our Dignity, our Future. Strasburg, 22/11/2016. Available at: [https://ec.europa.eu/europeaid/new-european-consensus-development-our-world-our-dignity-our-future\\_en](https://ec.europa.eu/europeaid/new-european-consensus-development-our-world-our-dignity-our-future_en)
- Gibbs, G. R. (2007). *Thematic Coding and Categorizing. Analyzing Qualitative Data*. London: SAGE Publications, Ltd.
- Human Development Report. (2016). *Human Development for Everyone*. New York. Available at: [http://hdr.undp.org/sites/default/files/2016\\_human\\_development\\_report.pdf](http://hdr.undp.org/sites/default/files/2016_human_development_report.pdf)



- Karanikola, Z. & Panagiotopoulos, G. (2018). International organizations policies and new era of work: Education in what skills? *International Journal of Learning and Development*, 8 (4): 79-88.
- Μυλωνόπουλος, Δ., & Μοίρα, Π. (2011). *Ευρωπαϊκή Ένωση και Τουρισμός*. Αθήνα: Ανοικτή Βιβλιοθήκη.
- Παναγιωτόπουλος, Γ., Καρανικόλα, Ζ., & Ανδρεαδάκης, Ν. (2019). Ανάπτυξη ανθρώπινου δυναμικού κα διεθνείς οργανισμοί. (σ. 17-30). Στο Ν. Ανδρεαδάκης, Ζ. Καρανικόλα, Μ. Κόνσολας, & Γ. Παναγιωτόπουλος (Επ.) *Ανάπτυξη Ανθρώπινου Δυναμικού. Επιμόρφωση και Διεθνείς Οργανισμοί*. Αθήνα: ΓΡΗΓΟΡΗ.
- Stoddart, H. (2011). *A Pocket guide to sustainable development governance*. Stakeholder Forum.
- UNESCO (2015). Recommendation on Adult Learning and Education. Paris. Available at: <http://unesdoc.unesco.org/images/0024/002451/245119M.pdf>
- United Nations General Assembly. (1987). Report of the world commission on environment and development: Our common future. Oslo, Norway: United Nations General Assembly, Development and International Co-operation: Environment.
- United Nations General Assembly. (2000). United Nations Millennium Declaration, Resolution A/RES/55/2 of 8 September 2000.
- United Nations General Assembly. (2015). Transforming our world: the 2030 Agenda for Sustainable Development, Resolution A/RES/70/1 of 25 September 2015.

**TOPIC 5: POLITICAL ORIENTATION, POPULISM AND EUROSCEPTICISM**

## 5.1. Conceptual and empirical analysis of modern Euroscepticism: The cases of France, United Kingdom and Italy

*Georgios Nastos<sup>1</sup>*

### Abstract

Understanding the multidimensional nature of euroscepticism is not only a matter of normative issues concerning efforts to deepen European integration, it also raises issues of political behavior, identities, public policies, democratic legitimacy, economy, ideology, and other areas. Euroscepticism is a heterogeneous and dynamic phenomenon, which is not defined as a concept by a commonly accepted theoretical framework. In a wider context, it refers to the opposition to the European Union, either in its entirety, as a supranational organization, or in its existing structure, form and political direction. Moreover, euroscepticism, in different interpretative contexts, is something that is expressed in a political system both on the left and right of the political spectrum. The economic and financial crisis, along with the fiscal adjustment policies that followed, on the one hand, and the refugee crisis on the other, contributed to the increase of negative attitudes towards the EU from its citizens and provided the space for the development of eurosceptic parties and groups, invested with a populist and nationalist agenda. The purpose of this study is to outline the modern parameters of euroscepticism within the EU. After the theoretical framework and the necessary conceptual clarifications on the term of euroscepticism, this paper examines three case studies. The cases of France, the United Kingdom and Italy are studied in relation to the development of euroscepticism in the past few years, both within the party system and in that of public opinion. The findings show that euroscepticism is largely related to issues of sovereignty, identity, and to the degree of confidence in the national political system. Furthermore, euroscepticism is related to the two major crises the EU has been called on to face and which have severely damaged its image - the economic and refugee crises. The methodology includes bibliographic research and the secondary analysis of quantitative data through Eurobarometer surveys on trends in public opinion towards the European Union.

**Keywords:** Euroscepticism, European integration, European Union.

### 1. What is euroscepticism?

Widespread use around the term of euroscepticism has not allowed the formulation of a specific and common definition of it. According to Paul Taggart, euroscepticism in a broad sense expresses the idea of a limited opposition up to an absolute one to the process of European integration (Taggart & Szczerbiak, 2004). Focusing on political parties, Taggart and Szczerbiak distinguish between hard and soft euroscepticism. Hard euroscepticism mainly concerns parties which believe that their countries have to leave the European Union, with the opposition to the European project being a basic principle of the party. Soft euroscepticism is mainly expressed by opposition to some EU political choices or when it is believed that these policies have a negative effect on national policies and are against the national interest. Here the opposition to the European project is not a basic principle of the party (Szczerbiak & Taggart, 2017).

In a different approach, Mudde and Kopecky base their ideas on David Easton's basic distinction between the various forms of support for political regimes (Kopecký & Mudde, 2002). They note two dimensions through which it is possible to study support or scepticism towards European integration. They distinguish between

---

<sup>1</sup> Political Scientist MSc, University of Crete

"diffuse" and "specific" support for European integration. Diffuse support refers to support in the general ideas of European integration that underlie the EU. Specific support refers to the general practice of European integration, meaning the EU as it is and how it is developing. The first dimension, "support for the ideas of European integration", separates "Europhiles" from "Europhobes". Europhiles, according to Mudde and Kopecky, believe in the basic ideas of European integration on which the EU is based. Europhobes do not support and often oppose the general ideas of European integration on which the EU is based, in other words, reject one or more of the ideas that form the basis of European integration. The second dimension, "support for the European Union", separates the "EU - optimists" from the "EU-pessimists". Optimists believe in the EU as it is and as it is developing, either because they are satisfied with the way it is created and operating, or because they are optimistic about the direction of the EU's development. EU pessimists do not support the EU as it is at the moment or are pessimistic about its course of development. This does not necessarily mean that all EU pessimists oppose EU membership. Some simply believe that the current EU is a serious deviation from the interpretation of the fundamental ideas of European integration and hope to change the EU.

Werfhorst and colleagues distinguish between the political, cultural and economic approach of Euroscepticism (Van de Werfhorst et al. 2012). The political approach interprets euroscepticism through the degree of trust in the European institutions. The cultural approach explains euroscepticism through the fear of loss of national identity. The economic approach of euroscepticism is based on the theory of utility, involving the costs and benefits that European integration implies for the individual. Thus, income inequality and the perception of whether or not someone feels they have gained or lost through the process of European integration can explain the individual attitude towards it.

Summarizing in the following table these, as well as other studies (Flood,2002; Krouwel & Abts,2007; Boomgaarden,2011; Ritzen et al.,2014; Boros & Vasali, 2013; Condruz-Bacescu,2014;) regarding euroscepticism, we see the individual issues on which Euroscepticism is based:

<b>Euroscepticism</b>	
Political factors for the development of eurosceptic attitudes	Socio-economic Democratic legitimacy National sovereignty Identity
Criteria for the development of eurosceptic attitudes	Effectiveness Utility Perceptions for the future (deepening, enlargement)

Recipients of eurosceptic attitudes	Authorities: Political actors EU political system: Institutions / bodies European Community: values / principles / objectives of European integration	
Degree of Euroscepticism		
Soft	Targeted	Hard
Criticism in individual policies Acceptance of the European project. Acceptance of basic principles and values Optimism about the future	Criticism in individual policies Caution on the existing form of the EU / Need for remodelling Acceptance of basic principles and values Concern about the future	Complete rejection of the EU and the process of European integration. Rejection of basic principles and values Pessimism about the future

## 2. Economic and refugee crisis

The modern parameters of Euroscepticism concern the period from 2008 onwards. At this time, the European Union was called upon to face two of the biggest crises in its history. The economic and financial crisis and the refugee crisis. Euroscepticism is a multifactorial phenomenon, which takes on different dimensions from country to country. Therefore, it would be a mistake to base the cause of disaffection against the EU solely on economic criteria. Nevertheless, several studies associate the rise of euroscepticism with the effects of the economic crisis. Serricchio and colleagues, while claiming that issues of identity and functionality of the EU institutions remain the key source of Euroscepticism, they point out that the greatest increase in euroscepticism has occurred in those countries most affected by the crisis (Serricchio, Tsakatika & Quaglia, 2013). Braun and Tausendfund (2014) show that in times of crisis, economic actors play an important role in supporting the EU, leading to a critical assessment of the future of the European integration process. Armingeon and Ceka (2014) conclude that a sharp drop in EU support has taken place in those countries most affected by the crisis and the resulting austerity measures imposed by the EU and the International Monetary Fund.

The management of the EU refugee crisis, peaking in 2015- 2016, was another area of public disaffection with the EU. The swelling of refugee and migratory flows, mainly from Syria and other Middle Eastern countries, as well as from North Africa or Asia to the EU, constituted a tool for various extremist eurosceptic parties that have exploited that disaffection, gaining in many cases significant electoral benefits. Many citizens, commentators and political parties, irrespective of their ideology, seemed to blame the EU for the refugee crisis. Some stressed the fact that the EU did not do enough to provide basic assistance to people in need, redistribute refugees and speed up asylum application procedures. Others argued that the EU did not do enough to secure its external borders, challenging the Schengen treaty.

### **3. Euroscepticism and ideology**

Euroscepticism is a heterogeneous and dynamic phenomenon, both between political parties and voters. Euroscepticism is something that is expressed in a political system on both the Left and Right of the political spectrum. However, there are substantial differences between Left and Right wing citizens regarding the motivations of Euroscepticism (Van Elsas, Hakhverdian & Van der Brug, 2016). Krouwel and Abts (2007) link euroscepticism to populism, pointing out that populism is capable of fuelling euroscepticism through two mechanisms. On the one hand, populists generalize disaffection towards specific policies or politicians in general, with a diffuse disaffection towards the EU and its institutions. On the other hand, they exploit the negative observations and assessments of the citizens, turning them towards political cynicism, even alienation. Carlotti (2015) identifies the concept of euroscepticism with populism as a protest both against the European Union and the national political system and the elites, considering that both are penetrating into the right and left of the political spectrum.

Leftist eurosceptics are dissatisfied with the current functioning of the EU but do not oppose further European integration per se. As van Elsas and colleagues point out (2016), the euroscepticism of radical left-wing parties stems from the defence of the welfare state and from their opposition to the ever-increasing liberalization of the market. For most radical left-wing eurosceptic parties, euroscepticism is a rejection of the current composition and practices of the EU, not a rejection of the principles of European integration itself. Meijers notes that the euroscepticism of the radical left is driven by economic concerns about the integration process. The radical left considers that the institutional structure and policymaking of the EU are ideologically biased in favour of the neo-liberal market policies (Meijers, 2017).

Radical right-wing eurosceptic parties disagree with the threat posed by European integration to national sovereignty and cultural homogeneity. Meijers (2017) points out that the radical right rejects transnational integration based on cultural arguments. This rejection of European unification is the result of the nativism view of the far-right. According to it, only the members of the indigenous group, of the nation, are the legitimate constituents of a state. Vasilopoulou (2018) stresses that despite the fact that radical right-wing parties tend to adopt different positions on the principles, practices and the future of European integration, all tend to criticize the EU mainly through an ethnocentric perspective based on sovereignty issues. As Halikiopoulou and colleagues point out (2012), the priority of the far-right parties is to protect the nation from foreign influences. Therefore, their policies are directed against immigration by presenting an ethnocentric message that highlights the EU's incompatibility with national values, seeking to "save" the "threatened" nation from what they perceive as cosmopolitan, decadent, foreign and anti-national influences. Nicholas Startin (2017) suggests that radical right-wing parties increasingly use their opposition to the EU as a tool to help them move beyond their traditional, mono-emblematic anti-immigration label. Such a strategy, says Startin, allows parties of the extreme right, not just to broaden their electoral base, but also to "destigmatize" themselves, by often concealing xenophobic and generally extreme behaviours, thus improving their external

image. Radical right parties base their euroscepticism on three arguments. First, from a socio-economic point of view, focusing on the economic crisis, the weaknesses of the common currency and the neoliberal model in general. Secondly, in developing their arguments on sovereignty on the basis of the community and the nation. Thirdly, linking the refugee crisis with their arguments on security, border control and immigration policy.

In a different approach, Kneuer (2019) argues that the rise of populist and eurosceptic parties is consistent with the assumption of a new cleavage. This cleavage includes integration against exclusion and european/cosmopolitanism versus nationalist orientation, intersecting vertically the ideological axis Left - Right. Also, de Wilde and colleagues (2017) make the assumption that perhaps Euroscepticism is not an isolated phenomenon based on specific issues but is more part of a wider new cleavage that incorporates an increasing number of issues.

#### **4. France**

The modern aspects of Euroscepticism in France are not limited to issues of national sovereignty as in the past. Mistrust and scepticism towards the EU in recent years has strong economic and social characteristics. Euroscepticism and its role in the domestic political scene is strengthening through the increased French disaffection with Germany and the EU, mainly due to France's weakening influence in the EU, as it is forced constantly to retreat against Germany. Since 2008, every French government has been striving for the widest possible compliance with the European criteria on the one hand and the preservation of the welfare state on the other. In fact, France is somewhere in the middle of the north - south division (Lequesne, 2015). Looking to the north, France has no choice but to compromise with Germany on the rationalization of public finances. To the south, France often expresses its solidarity to the countries tested by the recession, the heavy debts and deficits, supporting their financial support from the European mechanisms.

The economic crisis is beginning to have an impact on public opinion, with the positive figures for the EU, falling after 2009. Apart from economic issues, the refugee crisis has also had a catalytic role in shaping and raising euroscepticism in France. Repeated terrorist attacks in France have prompted an increase in xenophobic tendencies, especially against Muslim populations, with the refugee issue appearing to engage public opinion, both for fear of altering national identity and over security matters. It is significant that 2008 found the positive image of the EU in France above the negative trends, with 46% of the French having a positive image of the EU compared to 21% with a negative attitude. Ten years later, the image of the EU in French public opinion seems to have been reversed. The percentages of those viewing the EU positively are decreasing, while the EU's negative image rates rose to a peak in 2013 and 2016 where negative EU figures have outpaced the positive ones.

Figure 1:

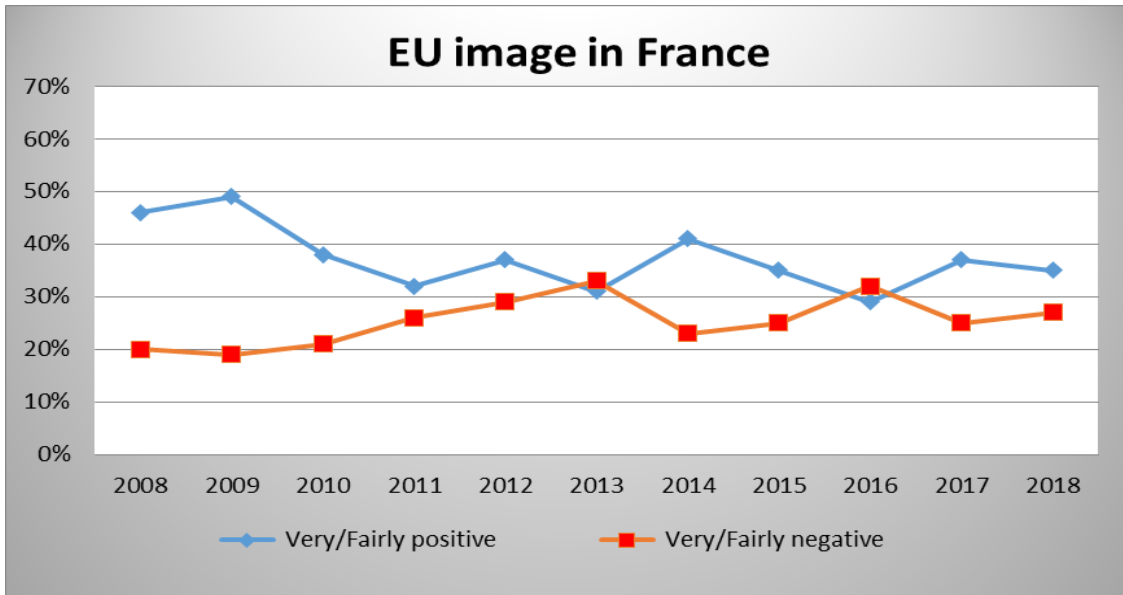

The economic crisis is a turning point in citizens' perceptions of and their confidence in the European Union. In 2007, 51% of French people said they trusted the EU, compared to 34% of those who said they did not trust the EU. Since 2008 and the years that followed, this confidence has been shaken, with confidence rates towards the EU falling significantly, with small fluctuations, to reflect in the year 2018 the lack of confidence of French public opinion towards the European Union at 33% ,compared to 57% which shows confidence towards the EU.

Figure 2:

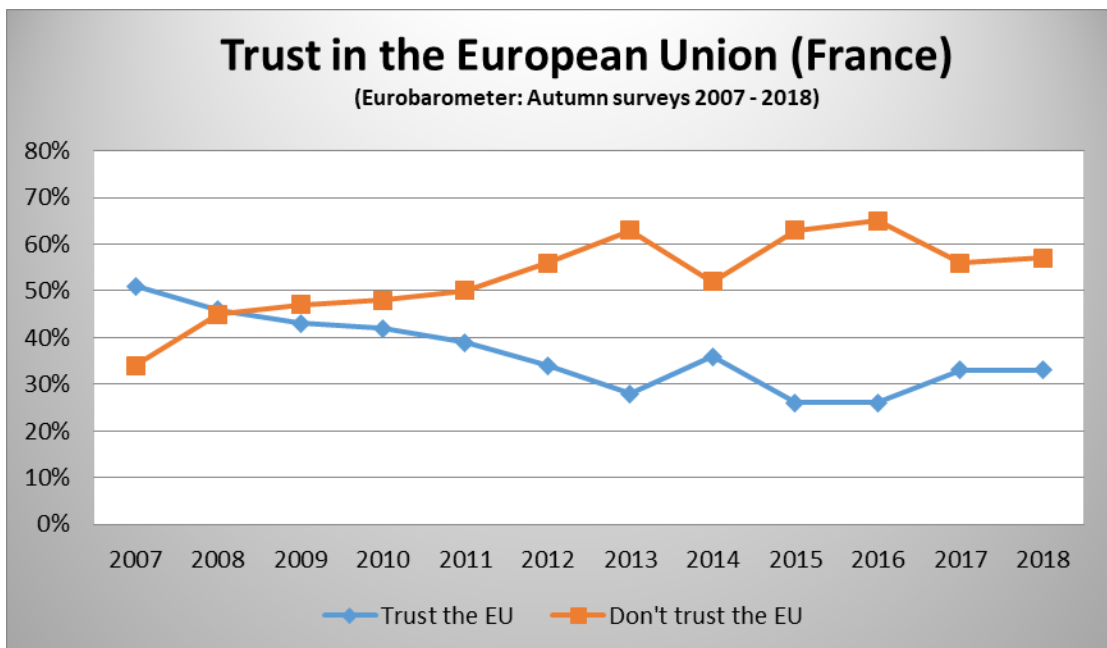



According to the latest Eurobarometer surveys, the issues that French people focus on at the European level, are those linked to the causes of euroscepticism in Europe. On the question of what the two most important issues the EU is facing at the moment, the migrant issue dominates with 33%, followed by terrorism, climate change and the economic situation (Eurobarometer 90, 2019).

The French political system embodies Euroscepticism both on the right and left of the political spectrum. Opposition to the European Union, apart from a characteristic political or ideological feature of a eurosceptic party, is also a tool of party competition. The referendum on the Maastricht Treaty in 1992 and the politicization of the European issue in France have been opportunities for eurosceptic parties, particularly to the right of the political spectrum, by demonstrating an anti-European electoral base that could be mobilized to their benefit. Throughout the 1990's, new parties and initiatives by political actors who left the majority parties tried to assemble and represent the French who expressed their opposition to the EU (Reungoat, 2017). In the years that followed, these parties not only paved the way for the development of an anti-European public opinion but also influenced the agenda of major pro-European parties. The result was, in the first case, their contribution to the rejection of the constitutional treaty in the 2005 referendum, while in the second, the adoption by the major parties of a more critical approach towards the EU, referring to the need for "change" or for "another Europe". After various transformations among smaller parties, the expression of opposition to the European Union in France was concentrated around two middle parties on each side of the political spectrum. The coalition of the remaining Communist Party with the Jean-Luc Mélenchon movement on the left and the Front National (FN) with Marine Le Pen on the right. The result of this electoral transformation in France was FN's historic success in the 2014 European elections, which made Marine Le Pen the main spokesperson of far-right euroscepticism in Europe. FN came first in votes with 24.8%, electing 24 MEPs and raising its support by 18.5% compared to the 2009 European elections.

Under the effects of the economic crisis, strict fiscal adjustment rules, the refugee crisis and the fear of repeated terrorist attacks by extreme Islamists both in France and other European countries, French euroscepticism was further strengthened at the presidential elections in 2017. In the first round for the next French president, Marine Le Pen of the FN, won 21.3% of the votes, passing to the second round, a little behind the leader in votes Emmanuel Macron who gained a 24.0% share of the votes. Eurosceptic leftist Jean-Luc Mélenchon of the "Rebellious France" party (La France insoumise, FI), came fourth with a share of 19.6% of the votes.

## **5. United Kingdom**

On June 23, 2016 UK citizens were called to the polls to decide whether or not Britain should remain a member of the European Union. 51.89% of the British decided their country should leave the EU, shocking not only Europe, but also the domestic political system, the media and the academic community. But the truth is that Brexit is nothing more than the result of the opposition to European integration, which has always existed both in the party system and in public opinion throughout the European course of Great Britain. Besides British peculiarities in the country's relationship with the EU, Brexit cannot be studied irrespective of the general

trends of euroscepticism that have grown across Europe, as well as the crises and challenges the EU has faced in recent years. Key issues such as supranational control against national sovereignty or those technocratic-depoliticized government on the one hand and the voices for greater accountability and democratic control of the political agenda on the other, concern both the UK and the rest of Europe (Martill & Staiger, 2018).

National sovereignty and identity are at the core of the British euroscepticism that is expressed in political rhetoric, as well as in the media and public opinion. At the same time, in the UK, the EU is perceived as an organization characterized by opaque processes, undemocratic and bureaucratic governance that stifles individuality, initiative and entrepreneurship (De Wilde, Teney & Lacewell, 2017). Summing up the concept of sovereignty in three dimensions, Gifford (2010) discerns its implications in the UK-EU relations. Firstly, as a political principle, the notion of sovereignty in the United Kingdom is perceived as a parliamentary sovereignty in which the supremacy of the national parliament is emphasized over any other legal body. Secondly, as national sovereignty that raises questions of legitimizing decision-making stemming from a clearly defined body of citizens. National sovereignty refers to the right of the British people to decide and legislate for the British, without any external constraints. Thirdly, as economic sovereignty, which in the case of the UK is understood in terms of separation of public authority from private property and the market. British eurosceptics, especially among the conservative elites, perceive the UK as a global rather than a European actor. In this point of view, the EU is an obstacle to the ability of the United Kingdom to exercise its economic and business leadership.

Although euroscepticism in Britain has been more closely associated with the Conservative party, it has been characteristic of both major parties (Conservative and Labour). The belief that the UK is somewhat unique and can contribute something distinct and unique to Europe, which is supposedly lacking, has been a constant perception of both Conservative and Labour parties (Gifford, 2010). The passage from the Maastricht Treaty in 1992, despite the ratification of the Treaty by the British parliament, established a division within the conservative party between pro-Europeans and eurosceptics, who were sceptical about the supranational elements of the Treaty and were especially against the aspirations related to the common currency and CFSP (Common Foreign and Security and Defence Policy) (Martill & Staiger, 2018). Moreover, the acceleration of the European integration process at the time, gave rise to the emergence of new eurosceptic parties such as UKIP (UK Independence Party) and BNP (British National Party), which do not simply follow the anti-European rhetoric of the conservatives, but they went a step further by proposing the full withdrawal of the country from the EU. Alongside the hard euroscepticism a new generation of soft eurosceptics came to the surface who declared in favor of the EU but firmly opposed to the euro and were against any conversation regarding British participation in the monetary union (de Wilde, Michailidou & Trenz, 2013).

**The influence of UKIP:** The UK Independence Party (UKIP) was founded by Alan Sked in 1993 on the occasion of the campaign against ratification of the Maastricht Treaty. It is distinguished as the British party that calls for the complete withdrawal of the United Kingdom from the European Union. Elements of

euroscepticism on which the UKIP has based its campaigns over the years, are related to the loss of national sovereignty over the EU institutions, the references to the need for the United Kingdom to remain outside the single currency, the lack of democracy in the EU due to the unelected nature of the European Commission, the inability of the European Parliament to represent the citizens of the Member States, excessive regulation of the single market and the UK's inability to achieve independent international trade agreements and migration issues arising from EU membership (Whitaker, 2017).

The party is organized around the fundamental argument that the suffering of British society could be greatly alleviated only if the country were ruled exclusively by the British Parliament, without the foreign enforcement of Brussels. Regarding the fears of loss of sovereignty, UKIP argues that membership of the EU is a threat to British democracy. It argues that more and more political issues are set at the EU level and not by the British political system, with the result that British voters lose control over these decisions. On identity issues, the party puts forward a strategy that, as it claims, seeks to "restore Britishness", notably through the limitation of immigration and changes in asylum procedures. The rise of the UKIP came in the 2004 European elections when the party ranked third, securing 16.1% of the votes and 12 MPs in the European Parliament, while in the European Parliament elections in 2009 it increased its power with another MEP. The UKIP's great success was in the 2014 European elections, where it won the top spot, with 27% of the vote. It was the first time that another party apart from Labour and Conservatives gained first place in the European Parliament elections. Pressure from the UKIP on the Conservative party played a key role in David Cameron's attitude, leading him to promise to renegotiate Britain's role in Europe and hold a referendum on the country's stay in the EU (Dye, 2015).

**British public opinion:** The main factors that led to the decision of the British people to leave the European Union are identical to those mentioned above as diachronic features of British Euroscepticism - that is issues of sovereignty and identity. The decreased participation of the last few years in the elections, the mistrust of the political elites, as well as the reduction in the support and participation of the two major systemic parties, have been a precursor to the following developments. As Graham points out (2017), issues of identity and sovereignty were crucial during the referendum process. However, he notes that these issues may have served as a pretext to cover a range of economic, cultural and political concerns and uncertainties that went beyond the institutional and legal nature of the UK's relationship with the EU. Issues of immigration, political detachment and economic insecurity have been particularly important concerns that have been expressed in the referendum and have been harnessed by the campaigns for the UK's withdrawal from the EU. Brexit, according to Graham, is part of a wider wave of populism created by the devastating effects of the 2008 economic crisis and the long-standing legitimacy crisis of party political systems of democratic representation (Graham, 2017).

As already mentioned, the emergence of eurosceptic tendencies within the EU Member States is largely related to the disapproval of the national government and their inability to address the domestic problems of the

citizens. Vasilopoulou (2016), mapping the factors that may have influenced Britain's decision to withdraw their country from the EU, claims that this is not the case regarding Brexit. Attitudes of the citizens towards European integration is marked as the determining factor in contrast to domestic party, economic and political issues. This attitude is compounded by concerns about the extent to which the UK has benefited or not from its EU membership, as well as preferences on specific issues related to the freedom of movement of persons within the EU. Also, divisions and ambiguities about EU positions in the Conservative and Labour parties suggest that the two sovereign parties are less able to provide their voters with clear messages, despite the support of their leaders in favor of the country's remaining in the EU. Vasilopoulou, as far as public opinion is concerned, concludes that European freedom of labour, immigration, border control, as well as issues related to ethnic diversity and multiculturalism are the core of British people's concerns about their country's participation in the EU.

**Figure 3:**

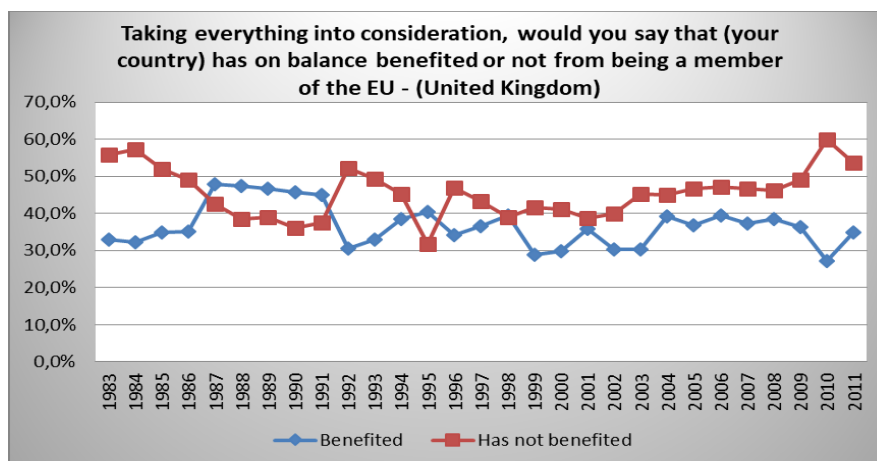

The cost-benefit assessment of the UK's EU membership, based on some benchmarks, is also shared by De Vries (2017). In the analysis of the factors determining the attitudes towards the EU, apart from the mapping of personal characteristics such as economic situation, profession, educational level, national identity, and so on, the roots that determine this attitude are in the comparison of the benefits resulting from the current status quo of the country's participation in the EU, compared to those deemed to arise from an alternative situation with the UK being outside of the EU.

The United Kingdom has always held the most eurosceptic public opinion among the EU Member States. The negative attitudes towards the EU in Britain peaked in 2011, with the negative image of the EU reaching 49%, with the corresponding positive image of the EU at only 13%. It is also noteworthy that this attitude is reversed after the referendum, with EU-positive figures rising above the negative a few months after the "Leave" vote, and while procedures are taking place for the UK's exit conditions.

Figure 4:

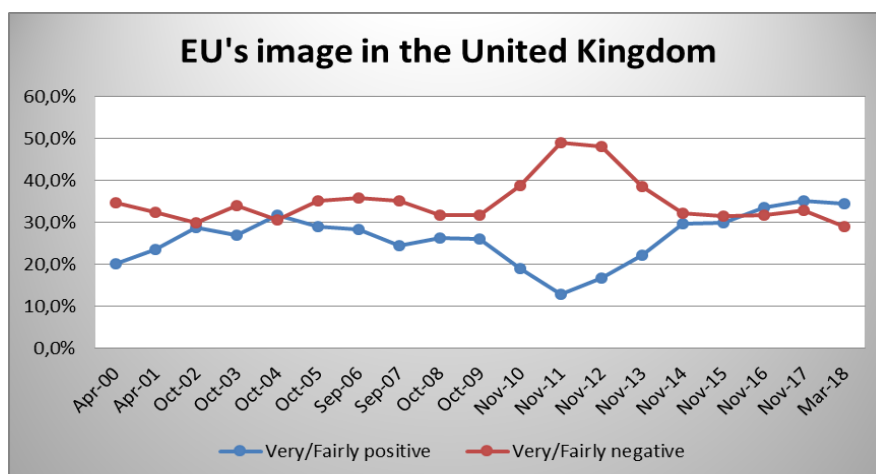

## 6. Italy

In Italy – one of the founding countries of the European ideal, we witness for the first time in the EU, a thoroughly Eurosceptic government rising to power. The migration and economic crisis, combined with the disappointment of the citizens with the national political system, fueled the Italians' opposition to the EU, voicing through a coalition government committed to clash with EU policies, both on economic and immigration issues. Italy presents a case that combines not only the upward populist tendencies but also their union in June 2018, in the last "yellow-green" government, which consists of a eurosceptic coalition between two parties: "Lega" and the "Five Star Movement".

**From pro-europeanism to euroscepticism:** Beyond party competition, the Italians as a euro-enthusiastic nation, perceived the process of European integration as a political benefit for Italian society. Both geopolitical interests and results from EU membership explained the support for the EU integration processes (Vdovychenko, 2018). As Vdovychenko points out (2012), the Italians maintained quite positive attitudes towards the process of European integration both before and after the Maastricht treaty. While maintaining a somewhat negative view of the national elites, the Italians considered the European institutions more powerful to implement effective policies and give the right answers.

In recent years, the economic crisis and austerity policies instituted by the EU have led to the creation of a eurosceptic front with the emergence of new parties opposed to the integration process. Since 2011, the new political landscape in Italy has been marked by the end of bipolarism and the fragmentation of the party system, due to the scandals of corruption and the Italians' low confidence in the political system. The birth of a new populist, anti-political movement called "Movement of the Five Stars" (M5S) was a clear symptom of the deep crisis of Italian representative democracy (Vdovychenko, 2018). Morlino and Piana (2014) link the Italian shift to eurosceptic and populist parties with the economic crisis in an unstable political context, characterized by low government efficiency and performance, corruption, decline in electoral participation, fragmented and radical party antagonism, social inequality, high public debt and other pathogens of the domestic political

system. Beyond the economy, the immigration crisis in 2015 raised serious concerns about the capacity of the EU to respond effectively to major political issues. M5S and Lega gave the impression that a certain degree of autonomy would be built against the bureaucratic EU (Vdovychenko, 2018). By linking the Italian election results to the issue of European integration, Toygür (2018) highlights the support for extremist and eurosceptic parties in Italy. One of the key electoral commitments of right-wing political parties was the "recovery of control" over economic policies. Moreover, the migrant crisis, as elsewhere in Europe, has been exploited in the hands of the far-right parties, who have benefited from the citizens' disappointment regarding the attitude and policies of the EU on this issue. These two crises, coupled with weakened confidence in institutions and disappointment with the national political system, contributed to the rise of populist and Eurosceptic parties.

In the national elections of 2018, the first party in Italy was the Five Star Movement (M5S), winning 31% of the vote. At the Camp of the Right Alliance, which received 37% of the votes, Lega was first with 18.7%. After two months of negotiations and confrontations with the President of the Italian Republic, Sergio Mattarella, a coalition government of the Five Star and the Lega Movement was formed under Giuseppe Conte as prime minister.

When Matteo Salvini took over the leadership of the Lega Nord, the initial positions for turning Italy into a federal state with regional autonomy especially in the northern regions, were abandoned, with the party embracing Italian nationalism, emphasizing euroscepticism, its opposition to immigration, forming at the same time an alliance with other right-wing populist parties. Under the leadership of Matteo Salvini in December 2013, LN has moved away from its former political identity as the voice of northern Italy, raising as an enemy at the heart of its rhetoric the policies and institutions of the European Union. The enemy was no longer Rome, but Brussels, the European institutions and the threat to national sovereignty expressed by the EU. The European Union was openly called a "dictatorship", the common currency "a crime against humanity" and the party started proposals for the reform of the EU's treaties, including the Maastricht Treaty and the Schengen Treaty.

The Five Star Movement (Movimento 5 Stelle, M5S) was founded by well-known comedian, activist and blogger Beppe Grillo on October 4, 2009 as an ecological, antieuropean and eurosceptic party. The manifesto released during the formation of the party introduced M5S as a meta-materialist organization dealing with ecology and direct democracy. M5S is not linked to any traditional position in the political spectrum. Officially, it is neither Right nor Left. M5S is trying to maintain its original "ideologically neutral" perspective, claiming it is neither oriented to the right nor left, but is a neutral radical force of change. The M5S became popular among Italians in a nationwide manner both in terms of geography and political placement. The Movement has begun to attract supporters from both Southern Italy and former voters of the Right (Cremonesi, 2017). From the beginning, the Movement strongly criticized Italy's political elites, increasingly attacking the European Union and its ruling class. As Franzosi, Marone and Salvati point out (2015), this populist and antisystemic party has expressed a crucial but ambiguous position for the European Union and the euro, with

its euroscepticism being evident in the 2014 European elections. On the other hand, the analysis of voters' electoral behavior for the EP, shows that M5S differs from the "hard" Eurosceptic UKIP, its main ally in the Europe of Freedom and Democracy Group (EFDD), and is often closer to the pro-European parties of the EU, such as the Greens. The authors are of the opinion that, overall, the euroscepticism of M5S is more strategic than ideological.

**Public opinion:** The attitude of the Italians who were considered to be the most pro-European citizens of the continent seems to have changed towards the supranational system of the European Union with the emergence of eurosceptic tendencies. Before the major crisis of the economy and refugees, Serricchio (2012) records in his study the causes of the growing sense of disaffection shown by Italian citizens against Europe, a number of external factors such as the enlargement of the EU with the accession of the countries of Eastern Europe, a change that led to a change in the distribution of Community funding and a perceived threat to cultural identity, as well as internal factors such as the emergence of euroscepticism in some governmental parties. Factors that played a decisive role in the progressive disaffection of Italian citizens with the supranational entity that they had always faced with great enthusiasm.

Figure 5:

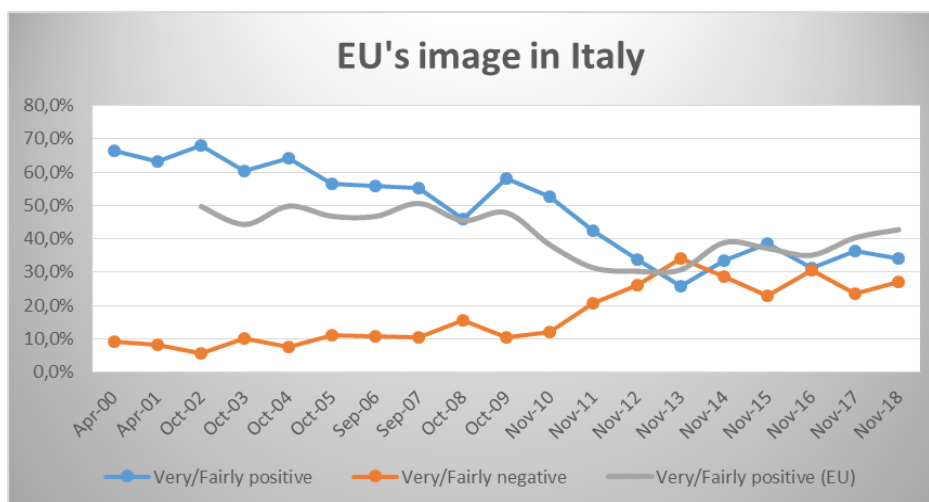

Italy had consistently recorded a positive image of the EU and above the European average. The positive image of the EU had constantly exceeded 50% compared to the negative image at 15%. From 2009 onwards the downward trend of this indicator begins at a peak in 2013 where the negative image of the Italians towards the EU reached 34%, surpassing the positive, which fell to 28%, and for the first time below the corresponding indicator between all Member States. The same downward trend is also reflected in the indicator of the benefits that the Italians perceive they have gained from membership in the EU.

**Figure 6:**

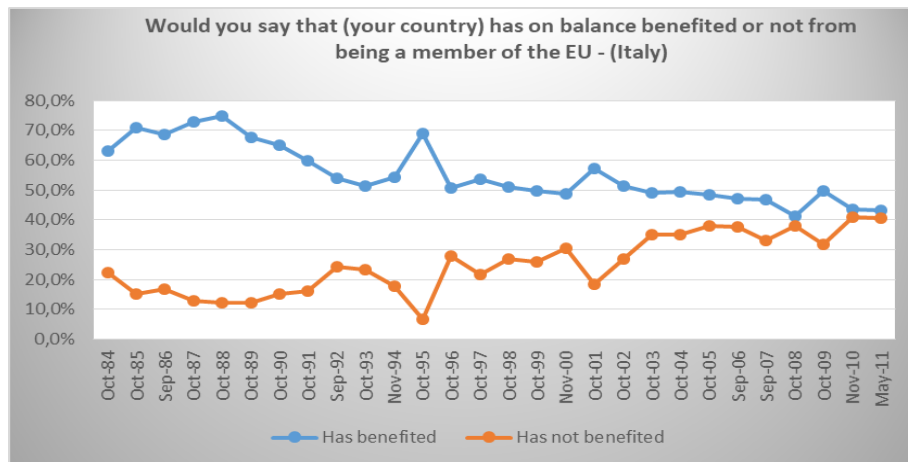

An even clearer picture of the rise of euroscepticism in Italy is the loss of confidence in the European Union. In particular, from 2011 onwards, there is a steady superiority of those who say they do not trust the EU. Looking at the chart of this indicator over time, it is clear that over 50% of previous confidence in the EU has been replaced by mistrust of the EU.

**Figure 7:**

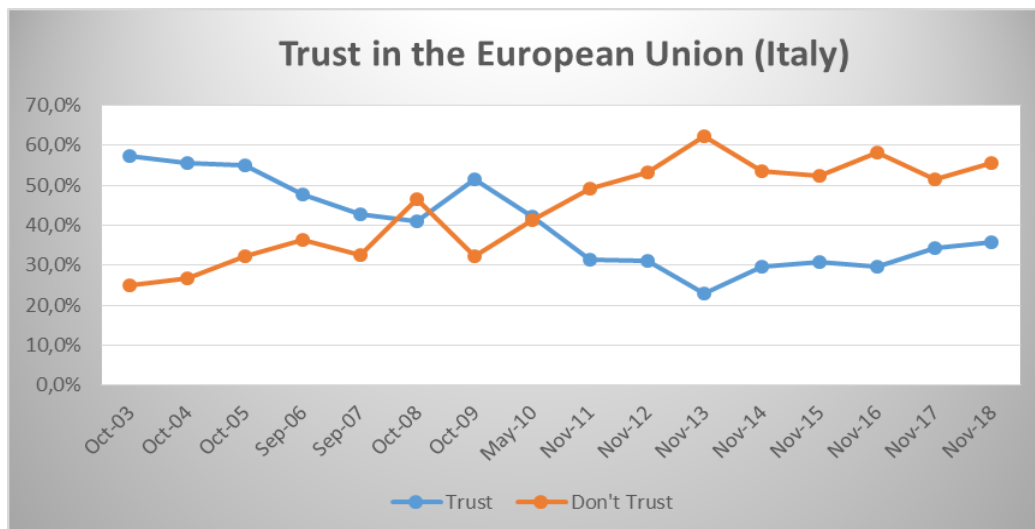

The three most important issues that the Italians feel they face are unemployment, immigration, and the economic situation (Eurobarometer 90, 2019). Indicative responses to the two recent major crises that can be seen to have raised negative trends regarding the EU. Debomy (2018) points out that in around 2004 Italians stopped being more positive than the European average and that, from 2010 to 2011, in contrast to the European average that regained positive attitudes, the Italian index continued to decline until 2016. He attributes this to the bad economic situation in the country that has worsened in the wake of the economic crisis, as well as to the attitude of the country's populist parties that have launched attacks against the common currency, and have



linked disaffection with the national institutions with disaffection against the EU institutions. In the same study Rivière (2018) highlights immigration as one of the main issues that causes tension in Italy. As he points out, almost six out of ten Italians express a negative opinion on the migration of people from outside the EU (59% vs. 32% "positive" opinions), five points above the European average in negative opinions.

Finally, indicative of Italy's disappointment and disaffection against the EU is the fact that in November 2016 eurobarometer measurements showed for the first time a higher percentage of those who think that their country could better deal with the future outside the EU. While in 2012 56.5% of the Italians disagreed that the country could better deal with the future outside the EU against 28.8% who believed otherwise, in 2016 the majority in Italy (45.2%) answered that they could better deal with the future outside the EU. Although this trend was not repeated in subsequent measurements and the majority of citizens believe that the country will better address the future within the EU, the negative attitude remains high at over 40%.

Figure 8:

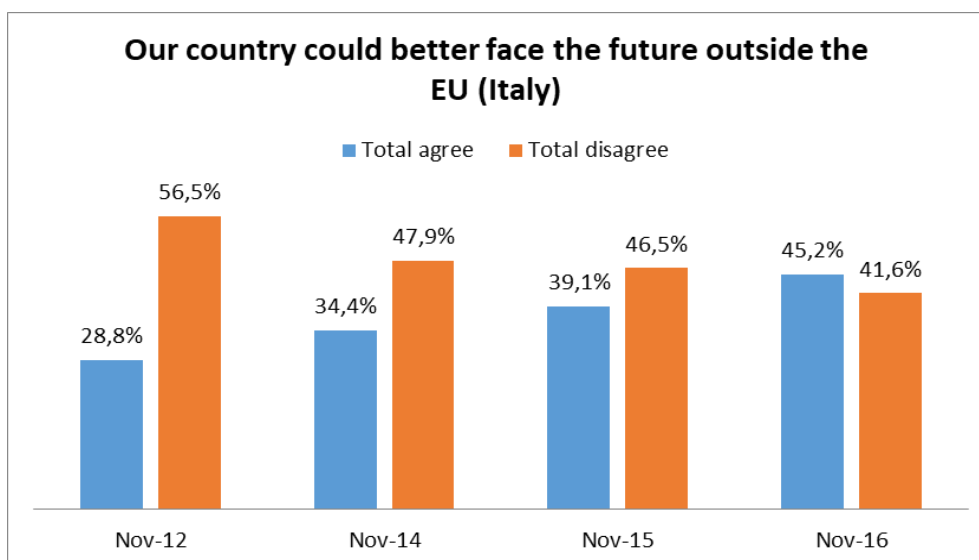

## Conclusions

Euroscepticism is a dynamic and heterogeneous phenomenon which takes different forms through space and time, without the existence of a single and commonly accepted theoretical framework to define it as a concept. Euroscepticism is not linked to a particular position on the Right-Left ideological axis. Many are those who point out that it may be a part of a wider new cleavage that incorporates an increasing number of issues. Many studies using the eurobarometer surveys show that the crisis in the Eurozone played a key role in the rise of euroscepticism in Europe. However, euroscepticism is not just a matter of economic issues. Strong disaffection against the domestic political system and fragmentation of the national party system may result in disaffection with the EU's bodies and institutions as well. Also, it is not clear whether the refugee crisis was a single factor or whether it contributed to the rise of euroscepticism combined with the consequences left behind by the economic crisis

Looking at the cases of France, the United Kingdom and Italy, we find that, with the exception of the long-standing eurosceptic United Kingdom, the image of the EU has suffered great damage during the years of economic and refugee crisis. Citizens' view that their country has benefited from its EU membership over the years has declined. In particular, the indicator of confidence towards the EU in France and Italy has been completely reversed by the clear positive trend that existed in the past. The result of the referendum in Britain can be interpreted as the long-standing manifest or latent opposition to the EU, the public's mistrust of it and the exploitation of this disaffection by various political actors who have managed to influence domestic political developments in the country, leading to a referendum on withdrawal at the time when the EU was dealing with perhaps the two biggest crises in its history. Although to varying degrees, in all three cases examined, eurosceptic parties have marked significant electoral gains.

## References

- Armingeon, K., & Ceka, B. (2014). The loss of trust in the European Union during the great recession since 2007: The role of heuristics from the national political system. *European Union Politics*, 15(1): 82–107.
- Boomgaarden, H. G., T., A. R., Elenbaas, M., & de Vreese, C. H. (2011). Mapping EU attitudes: Conceptual and empirical dimensions of Euroscepticism and EU support. *European Union Politics*, 12(2): 241–266.
- Boros, T., & Vasali, Z. (2013). The Rise of Euroscepticism and Possible Responses prior to the 2014 European Parliament Elections. *Foundation for European progressive studies*.
- Braun, D. & Tausendpfund, M. (2014). The Impact of the Euro Crisis on Citizens' Support for the European Union, *Journal of European Integration*, 36 (3): 231-245.
- Carlotti, B. (2015). Linking European Integration, Euroscepticism and Populism: theoretical Reflections and empirical Measurement. *Paper prepared for the ECPR General Conference, Montreal, Canada*.
- Condruz-Bacescu M. (2014). Euroscepticism across Europe: Drivers and Challenges. *European Journal of Interdisciplinary Studies, Bucharest Economic Academy, issue 02*.
- Cremonesi, C. (2017). *Populism and Euroscepticism, the case of the Italian Five Star Movement in 2013: an analysis of party direct communication and media coverage*. Retrieved from <https://www.researchgate.net>
- De Vries, C. E. (2017). Benchmarking Brexit: How the British Decision to Leave Shapes EU Public Opinion. *JCMS: Journal of Common Market Studies*, 55: 38– 53.
- De Wilde, P., Michailidou, A., & Trenz, H. J. (2013). The UK: A Case of Extraordinary Euroscepticism. In *Contesting Europe. Exploring Euroscepticism in Online Media Coverage*, ECPR Press University of Essex, pp. 173-194.
- De Wilde, P., Teney, C. and Lacewell, O. P. (2017), Euroscepticism: Stand-alone phenomenon or embedded within a broader cleavage?. In L. Benjamin, N. Startin and S. Usherwood (eds.), *The Routledge handbook of Euroscepticism*. London: Routledge.
- Debomy, D., Rivière, E. and Husson, A. (2018). The italians and europe, chronicle of disenchantment, *policy paper 217, Jacques Delors Institute*, retrieved from <http://institutdelors.eu/?lang=en>.
- Dye, D. T. (2015). The Language of Euroscepticism: UKIP Discourse in Comparative Context. *Paper prepared for the 2015 Political Studies Association Annual International Conference Sheffield, England–30 March-1 April*.
- Flood, C. (2002) Euroscepticism: A Problematic Concept. Paper presented at the UACES 32nd Annual Conference and 7th Research Conference. Queen's University Belfast.
- Franzosi, P., Marone, F. & Salvati, E. (2015). Populism and Euroscepticism in the Italian Five Star Movement. *The International Spectator*, 50 (2): 109-124.
- Gifford, C. (2010). The UK and the European Union: Dimensions of Sovereignty and the Problem of Eurosceptic Britishness. *Parliamentary Affairs*,. 63 (2): 321–338.
- Graham, T. (2017). *Understanding Brexit*. Emerald Publishing Limited.
- Halikiopoulou, D., Kyriaki N. and Vasilopoulou, S. (2012). 'The Paradox of Nationalism: The Common Denominator of Radical Right and Radical Left Euroscepticism', *European Journal of Political Research*, 51 (4): 504–39.

- Kneuer, M. (2019). The tandem of populism and Euroscepticism: a comparative perspective in the light of the European crises, *Contemporary Social Science*, 14 (1): 26-42.
- Kopecký, P., & Mudde, C. (2002). The Two Sides of Euroscepticism: Party Positions on European Integration in East Central Europe. *European Union Politics*, 3(3): 297-326.
- Krouwel, A., & Abts, K. (2007). Varieties of Euroscepticism and Populist Mobilization: Transforming Attitudes from Mild Euroscepticism to Harsh Eurocynicism. *Acta Politica*, 42(2-3): 252–270.
- Lequesne, C. (2015). France and the European Union: a Story of Reason Rather than Love. *Norwegian Institute for International Affairs*, 5/20115.
- Martill, B. and Staiger, U. (eds). 2018. *Brexit and Beyond: Rethinking the Futures of Europe*. London: UCL Press.
- Meijers, M.J.(2017).Radical Right and Radical Left Euroscepticism. A Dynamic Phenomenon, *Notre Europe Policy Paper:191, Jacques Delors Institute*, Berlin.
- Morlino, L., & Piana, D. (2014). Economic Crisis in a Stalemated Democracy: The Italian Case. *American Behavioral Scientist*, 58(12): 1657–1682.
- Reungoat, E. (2017). Changing the rules, changing the winners? The various effects of European election rules on party oppositions to the EU in France. In L. Benjamin, N. Startin and S. Usherwood (eds.), *The Routledge handbook of Euroscepticism*, London: Routledge.
- Ritzen, J., Zimmermann, K., Wehner, C. (2014). Euroscepticism in the Crisis: More Mood than Economy. *Journal of Economic Analysis and Policy*, 16 (2): 539-576.
- Serricchio, F. (2012). Italian Citizens and Europe: Explaining the Growth of Euroscepticism, *Bulletin of Italian Politics*. 4 (1): 115-134.
- Serricchio, F., Tsakatika, M. & Quaglia, L. (2013). Euroscepticism and the Global Financial Crisis. *Journal of Common Market Studies*, 51(1): 51-64.
- Startin N. (2017). ‘Euromondialisme’ and the Growth of the Radical Right. In L. Benjamin, N. Startin and S. Usherwood (eds.), *The Routledge handbook of Euroscepticism*. London: Routledge.
- Szczerbiak, A. and Taggart, P. (2017). Contemporary research on Euroscepticism: the state of the art. In Leruth, B., Startin, N., & Usherwood, S. (eds.), *The Routledge handbook of Euroscepticism*. London: Routledge.
- Taggart, P., & Szczerbiak, A. (2004). Contemporary Euroscepticism in the party systems of the European Union candidate states of Central and Eastern Europe. *European Journal of Political Research*, 43(1): 1-27.
- Toygür, I. (2018). A guide to understanding Italy: the 2018 elections and beyond, *Elcano Royal Institute retrieved from <http://www.realinstitutoelcano.org/>*.
- Van der Brug, W., Meindert, F. (2008). Euroscepticism and support for radical right parties. *Paper presented at the conference on ‘Representation, Immigration and the 2009 election to the EP*, Indiana University.
- Van de Werfhorst, H., Tóth, I. G., Horn, D., Medgyesi, M., Notten, N., Haas, C., & Burgoon, B. (2012). Political and cultural impacts of growing inequalities. Amsterdam: *Amsterdam Institute for Advanced labour Studies*. University of Amsterdam.
- Vasilopoulou, S. (2016). UK Euroscepticism and the Brexit Referendum. *The Political Quarterly*, 87: 219-227.
- Vasilopoulou, S. (2018). The radical right and Euroscepticism. In J. Rydgren (ed), *The Oxford Handbook of the radical right*, Oxford University Press, pp. 122-140.
- Vdovychenko, V. (2012). Out of Crisis with Another Europe: Italian Case. *Foreign Affairs of Ukraine*, no. 6.
- Vdovychenko, V. (2018). Through the Lenses of Italy’s Euroscepticism or a Tale for the Future of the European integration project. *Annales Universitatis Mariae Curie-Skłodowska, sectio K – Politologia*, 25:2, Wydawnictwo Uniwersytetu Marii Curie-Skłodowskiej.
- Whitaker, R. (2017). The UK Independence Party and Other Primarily Eurosceptic Parties. In L. Benjamin, N. Startin and S. Usherwood (eds.), *The Routledge handbook of Euroscepticism*. London: Routledge.

**TOPIC 6: MIGRATION – REFUGEE CRISIS AND EU POLICIES**

## 6.1. Sovereignty, Europeanism and borders: how migration is challenging concepts and patterns

*Giovanna Campani<sup>1</sup>*

*“Nationalism is not to be confused with patriotism. Both words are normally used in so vague a way that any definition is liable to be challenged, but one must draw a distinction between them, since two different and even opposing ideas are involved. By ‘patriotism’ I mean devotion to a particular place and a particular way of life, which one believes to be the best in the world but has no wish to force on other people. Patriotism is of its nature defensive, both militarily and culturally. Nationalism, on the other hand, is inseparable from the desire for power. The abiding purpose of every nationalist is to secure more power and more prestige, not for himself but for the nation or other unit in which he has chosen to sink his own individuality.”*

*George Orwell*

### Introduction

The 2015 refugee crisis - the biblical exodus of over one million people reaching Central Europe after a grueling walk over the Balkans, placed migration at the core of the political debates and provoked conflicts among the member states, while the European Union gave the impression of a loss of control of the external borders. Together with the “Balkan route”, thousands of migrants risked their lives to cross the Mediterranean on often unseaworthy boats.

In absence of any effective European Union action, the member states faced the dramatic events separately, implementing different policies - from a temporary “welcome refugees” to the building of “walls” aimed to block the migrants. The “welcoming” policies can be resumed by two sentences -one of Angela Merkel (“wir schaffen das”-we will manage- we can do it<sup>2</sup>) (Politico, 2016) and the other one of Matteo Renzi (“sono fiero di essere italiano. Rispettiamo i nostri valori. Noi salviamo vite umane”<sup>3</sup>- I am proud to be Italian. We respect our values. We save human lives). The generous approach didn’t last a long time. In front of the fears of their public opinion and the rise of the populist parties, as Alternative fuer Deutschland and the League, Germany and Italy, which had, initially, chosen to open their borders, promoted bilateral agreements with the transit countries, Turkey and Libya, in 2016 and 2017, in order to reduce or radically stop the flows.

---

<sup>1</sup> University of Florence.

<sup>2</sup> On the 31<sup>st</sup> of August 2015, after visiting a Refugees center, during thee following press conference, Merkel said: "I put it simply, Germany is a strong country ... we have managed so many things — we can do this."

<sup>3</sup> Matteo Renzi pronounced this sentence in a few occasions, complaining about the bureaucratic approach of the European Union in respect tio the costs Italy supported for rescuing and receiving migrants in the Mediterranean Seain Augst 205 and the following year, in February 2016.

The restrictive migratory policies- materialised by the building of new walls and barbed wires against migrant flows- are chosen by most European countries<sup>4</sup>. The Visegrad group<sup>5</sup>- is favourable to close hermetically the European borders and rejects any possible redistribution of the migrants among the EU member states. While the Visegrad countries are pointed out as examples of “populism”, little solidarity is shown by the other member states, even if they “theoretically” oppose the “building of walls” in name of “European values” and reject anti-immigrants populism. France, for example, imposes border controls with Italy (in Ventimille and Bardonecchia) and Spain (Port Bou), inside the Schengen open-border zone, in order to avoid inter-states movements, questioning one of the cornerstones of the Union citizenship, the freedom of movement and residence for persons in the EU, established by the Treaty of Maastricht in 1992.

The political outcome of the migration crisis was the “disunion” of the EU, revealing the fragility of the EU construction and bringing to light the unfairness of the EU rules, as the Dublin Regulation, part of the European Asylum system (CEAS), which imposes the huge burden of managing asylum seekers demands, on border countries -Greece, Malta, Italy and Spain- because of their geographical position.

The article develops the argument that the political impact of the migration crisis on the European political arena mainly depends from unsolved issues at the core of the European construction in the shadow of the globalisation processes. No doubts that the refugees flows in 2015 -one million and a half demands of asylum- represent a high burden for the administrative and social services of the EU countries. No doubts that the predicted African demographic growth (the continent’s population will double over the next 30 years because of very high fertility rates) may raise worries in the neighbouring continent (Smith, 2018). However, in a continent of more than 521 millions people (the United States have 327) with a GDP per capita (PPP) of \$37,800 in 2017 (compared to \$59,495 in the United States, \$42,695 Japan and \$16,636 in China) things should, theoretically, be manageable (as Angela Merkel said for Germany). Around four millions and an half of Venezuelans have left their country in the last years, reaching Colombia, Peru, Ecuador, Argentina (countries much poorer than the EU member states), but their exodus has not provoked the similar inter-states conflicts in Latin America (Voanoticias, 2020).

Migration has become such an explosive topic because it is at the core of multiple political issues that converge in the complex balance between the state sovereignty and the EU role, as supranational institution, in a world context characterised by the globalisation processes, by the hegemony of the neo-liberal ideology and by the

---

<sup>4</sup> According to data compiled by Anadolu Agency, there are currently around 20 walls or barbed wires on the borders of European countries. There has been a significant rise in walls and barbed wires after the 2015 refugees crisis. The walls and barbed wires built in Europe after the fall of Berlin wall in 1989 has surpassed 1,000 kilometers (621 miles), according to the Netherlands-based Transnational Institute. This number is six times larger than the length of the Berlin Wall, the study said. For further information see: [www.aa.com.tr](http://www.aa.com.tr)

<sup>5</sup> The Visegrad Group (also known as the "Visegrad Four" or simply "V4") reflects the efforts of the countries of the Central European region to work together in a number of fields of common interest within the all-European integration. Czechia, Hungary, Poland and Slovakia have always been part of a single civilization sharing cultural and intellectual values and common roots in diverse religious traditions, which they wish to preserve and further strengthen. For further information see: <http://www.visegradgroup.eu/about>

slow progress of the international conventions on human rights. These issues are easily exploited by the so-called populist forces, proposing a return to the nation states and their accountability in front of the citizens. They demand the states to get back control and sovereignty.

The term sovereignty has assumed a negative meaning in today's Europe. Or, according to the simple definition given by the Britannica Encyclopedia, Sovereignty, as "the ultimate overseer, or authority, in the decision-making process of the state and in the maintenance of order" is a basic political concept. The control of the borders and the decision to receive migrants (and how many) are part of the sovereignty, inside a system of peaceful international relations. Or, in the European Union, this "ultimate overseer" is challenged not only by ambiguous treaties and regulations, but also by the uneven power of the different member states: the political tensions over migration cannot be separated from the present structure and the future project of the European Union, in respect to sovereignty, nation, democracy, human rights, political rights and social rights.

### **Borders and cosmopolitanism**

A generous narrative, shared by the European anti-racist movements and a part of the left organisations supports the idealistic vision of a world of open/ no borders where everybody could move and live everywhere. The only border is the "humanity". "We are all humans, let's remain humans"- was the slogan that the anti-racist marchers and the NGOs opposed to the former Italian Interior minister Matteo Salvini, when he closed the Italian harbours to the boats of the migrants rescuers as Open Arms or Sea Watch.

Critics to the national borders point out the tragic consequences of borders on migrants: "National borders, in particular, have separated humanity into distinct communities, defining wage structures, access to welfare and standards of living. While borders are permeable to some privileged people, they are impermeable to most others. Migrants who cross national borders without permission are often criminalized and de-humanized, frequently lose their social, economic and political rights and, as a consequence, experience disproportionate exploitation and abuse" (Bauder, H., 2012).

The words of Harald Bauder denounce what can be considered one of the worst tragedies in our world: thousands of migrants dying in the Mediterranean Sea, under the indifferent eyes of the European citizens. To avoid these tragedies, Harald Bauder (2017) develops arguments for opening borders and for a world without borders. Alternative possibilities range from the practical forms of free movement already existing in some world areas to the utopian world where borders no longer exist, challenging the prevailing territorial organisation of the global populations into nation states (Bauder, 2017).

A world without borders has old and solid philosophical and anthropological foundations: who can deny that migrating is part of the experience of the Sapiens since the beginning of their adventure on the planet? Human movements have certainly preceded the historical construction of the borders. In a French movie of 1936, *La Grande Illusion*, starring Jean Gabin, the two heroes, two French soldiers, Maréchal et Rosenthal, escaped from a German camp during world war one, try to reach Switzerland. Marechal : "Dis-donc, t'es bien sûr que

c'est la Suisse, là-bas en face”, ... Rosenthal : “Qu'est-ce que tu veux, une frontières, ça s'voit pas, c'est une invention des hommes, la nature s'en fout...». Marechal "Tell me, you're sure it's Switzerland, over there," ... Rosenthal: "What do you want, a border, it is not visible, it's is an invention of men, nature does not care ... “.

If nature doesn't create borders, why did men invent them? Borders are necessary to define the political organisations of the different human groups. The fourth century before Christ, Diogenes of Sinope, sometimes known as Diogenes the Cynic, when asked where he was from, said 'I'm a citizen of the world.' The word he used was kosmopolites, from which our 'cosmopolitan' derives, so strictly speaking he was expressing allegiance with the cosmos<sup>6</sup>; but the term is usually translated as 'citizen of the world' (AEON, 2013). However, even if Diogenes considered himself as Kosmopolites, he passed into history as Diogenes of Synopis, the town where he was born.... For Ancient Greeks strong allegiance to the city-state was meant to be the source of identity, security, and self-respect. Correctly Diogenes reminded that we all have to be loyal to something more universal than our small community- to cosmos and humanity, but he became what he was -a critical philosopher- because of his experience in the Greek culture...if he would have born in Egypt or Babylon, he probably wouldn't have never been able to think to himself as a kosmopolites, ...

In the book *Cosmopolitanism, Ethics in a World of Strangers*<sup>11</sup>, Kwame Appiah (2006) poses the problem of the commonality of the humans and the tensions between the small communities where we used to live (and sometimes still do) amidst the vast heterogeneity of modernity. He also admits that there are times when the two ideals -universal concern and respect for legitimate difference clash...Our global world is still embedded in this type of contradictions...

### **Nation states and citizenship**

Over the centuries, the small communities -tribes or villages- have evolved into different typologies of political organisations -city states, empires, confederations, often coexisting at the same time. When, in 1534, Jacques Cartier arrived at the borders of the Saint Laurent river and asked the local population what was the name of their land, the answer was Kanada, that means “village, settlement” The Iroquois organised their social and political life around the villages and could not imagine that Cartier came from a large territory, the Kingdom of France, separated from other Kingdoms by borders defended by soldiers. Around the Iroquois villages, the huge territory of prairies, forests and rivers had no defined borders... Borders were recent in Europe as well: In feudal times, borders had been fluid. States -in the form of absolute kingdoms- took shape in modernity, In 1648, the Westphalian peace built a system that comprised sovereign state entities possessing the monopoly of force within their mutually recognised territories, whose populations had common traditions, namely the same religion.

In the eighteenth century, namely with the French Revolution, the populations of the sovereign states entities became free citizens. The state was combined with the nation -“l'ensemble des êtres humain vivant dans un

---

<sup>6</sup> “When asked where he was from, he said “I am a world-citizen”- ἐρωτηθεὶς πόθεν εἶη, “κοσμοπολίτης,” ἔφη.



même territoire, ayant une communauté d'origine, d'histoire, de culture, de traditions, parfois de langue, et constituant une communauté politique” (all human beings living in the same territory, having a community of origin, history, culture, traditions, sometimes language, and constituting a political community) (Dictionnaire Larousse, 2019). In the nation states, the sovereignty belongs to the people in the sense that all political power ultimately derives from the consent of naturally free and equal individuals, but this people, identified with a polity, is a specific cultural group (Lumenlearning, 2010). The nation-state provides a framework for a political order protecting the rights (political, civic and social) and heeding the voices of the members of the cultural group it has endorsed. This cannot be accomplished without clear lines of demarcation indicating who are the citizens, and who are not. Citizenship rights are, at the same time, a factor of union and division.

The concept of nation-state can be compared and contrasted with that of the multinational state, city-state, empire, confederation, and other state formations. During the XIXth and XXth centuries, the nation-state became the dominant form of modern political community, modifying some of its characters, namely in matter of citizenship rights.

Since World War two, the democratic European nation states added the social rights to the political and civic rights ensured to the citizens. The states have assumed a “social responsibility” in respect to the “[granting] the right to a modicum of economic welfare and security, the right to share to the full in the social heritage and to live the life of a civilised being according to the standards prevailing in the society” (Marshall, 1950). Some Constitutions, as the Italian one, included ensuring employment to the citizens as State’s task. Granting social citizenship, as defined in the UK by T.H. Marshall (Marshall, 1950), the states have accepted to play an important role in the economic domain, the state disposing of the necessary resources to ensure the welfare.

The “welfare state” has been a powerful instrument of inclusion for the citizens, creating special boundaries and expectations. The protection offered by the nation state to the citizens who were born or live permanently inside the state borders- isn’t generally granted -at least not fully- the non-citizens. Consequently, social citizenship produces at the same time processes of inclusion and exclusion of different categories of people, namely the non-citizens- the migrants.

### **European Nation states and migration**

The article is not going to discuss the history or the ongoing debate about the nation states, following the variety of the political approaches - liberal pluralistic, social-democratic, marxist, etc., but try to understand how the migration crisis in Europe is linked to the specific European history of the nation states and the changes that they have been going through in the last years. First of all, it must be clarified that migration has been considered a challenge for the European nation states since the XIXth century. Since the second half of the XXth century, migration - as a broad concept that included second or even third generations, and newcomers- has rbeen discussed in the political agendas both as a burden for the welfare systems and a cause of the weakening of the cultural and linguistic homogeneity. The European states migration policies have generally expressed various difficulties in incorporating immigrants in the society: restrictions in stay permits according

to the type of work or contract, delayed family reunification, assimilation strategies for settled migrants, have been common practice in most European countries. The present debate on migration, border controls, difficult integration, etc...fuelled by the populist political forces is nothing new.

In comparison with Europe, the social, cultural and political perception of migration took very different forms in the American continent, with variations from the USA to the Latin American countries. Over there, migration was incorporated in the narrative of the nation, as the sentence “Mexicans descended from the Aztecs, Peruvians from the Incas and Argentines descended from boats.” Ironically reminds<sup>7</sup>. While Canada and the USA developed the multiculturalist narrative and implemented the corresponding political project in the Seventies, most European countries, with the exception of the UK, continued with assimilationist approaches and showed skepticism towards the new Anglo-Saxon models to deal with migration and minorities<sup>8</sup>. While European societies have become more and more diverse, on the other, the assimilation models have not been abandoned, immigrants/ migrants being asked to assume the host country national identity.

### **Declining nation states? Globalisation and sovereignty**

Dominant form of modern political community, the nation state has, nevertheless, embarked on a declining curve of historical viability, following the globalisation processes and the European Union construction. Is it likely that this declining trend would bring a more favourable approach to migration and to a world without borders? That’s not sure at all. Let’s see why.

Roughly, globalisation refers to the increased movements of goods, capital, and services over borders, and the gradual transformation of national markets into regional and global markets. This passage is intermingled with an ideology and an economic model -neo-liberalism- a modern version classical liberalism that considers the States just as instruments eventually regulating the market, which should however remain free of movement. Globalisation and Neo-liberalism, through the idea of a minimal role for the state, have put in cause the nation states’ sovereignty, namely for what concerns the control of the national economy and, consequently, the possibility to maintain or to enlarge the welfare state. The neo-liberal ideology is against the social citizenship proposed by Marshall and the form of state that offers economic protection, suggesting that welfare programs are negative for society, because they promote passivity among the poor.

Even before the phenomenon of globalisation, especially after World War 2, the idea that the increase in the interdependence of states restricted the principle of state sovereignty had imposed itself among policymakers. In order to maintain peace and prosperity, several regional and international organisations were created- e.g., the North Atlantic Treaty Organization (NATO), the World Trade Organization (WTO), and the European

---

<sup>7</sup> The sentence is attributed to the poet and singer Facundo Cabral. For further information see: <http://newtravelist.com/2016/04/buenos-aires/>

<sup>8</sup> where it has been criticised by several conservative politicians as Cameron.

Union (EU)<sup>9</sup>, exercising a sort of “divided sovereignty” with the nation states (Encyclopedia Britannica, 2019)<sup>10</sup>.

On the contrary, when the loss of sovereignty has started to represent a degradation of the life conditions, affecting the welfare state and social citizenship, as it has been the case in the European Union, after the 2008 crisis, the reactions in front of the loss of sovereignty have been negative and easily exploited by the populist political forces. In 2008 with the economic crisis, the failing governance of the EU in the economic governance appeared clearly with the imposition of the austerity policies. The progressive dismantling of the welfare state and the social citizenship impacted the life of the middle and lower classes, creating broad discontents among the populations, who have rejected the supra-national governance.

The loss of sovereignty can be accepted for an improvement in the life conditions, not for their worsening, as it is the case in the EU in the last ten years. This, when the emotional implications of the nation states -*natio* has the etymological origin in the Latin verb “*nascere*” to be born, as Ernst Gellner (1983) remarked<sup>11</sup>-have not been replaced by any “European identity” sentiment. Almost thirty years after the Treaty of Maastricht, founding the European Union, European people still recognise themselves mainly as members of a nation state-Italians, French, Germans, Greeks... This “national” sentiment is even encouraged in front of a loss of sovereignty that doesn’t make any sense in terms of life improvements.

The failure of the EU in the economic governance has been coupled by the failure in the migratory crisis management. The loss of control of the EU borders has been strongly represented by the migratory crisis in 2015. The states -as Hungary- which opposed to uncontrolled migration made a strong argument about getting back their sovereignty in respect to border controls. This idea -opposing the loss of sovereignty of the nation states, sacrificed to supra-national or global dimensions whose positive aspects are difficult to be perceived by the European populations- was followed by other countries and by the populist forces, but is also embraced by many citizens, suffering under the weight of the economic crisis and nostalgic of the “protector” nation state, ensuring the welfare state.

As a consequence of these processes, in the European politics, the right-left conflict has been replaced by mainstream/populism over the last years. Controversial term, populism covers a large spectrum of parties, from the far right to the radical left, presenting very different agendas. Far right populist, also labelled national-right

---

<sup>9</sup> The Treaty of Rome envisaged the construction of the E.U. toward a “ever closer Union”.

<sup>10</sup> The citizens of the different nation states have generally well accepted the “divided sovereignty”, if this ensured the maintain of peace, as the NATO, or represented a promise for more prosperity, as the European Union.

<sup>11</sup> What is nationalism? “primarily a political principle which holds that the political and the national unit should be congruent” (Gellner, 1983: 1). The general imposition of a high culture on society, where previously low cultures had taken up the lives of the majority, and in some cases the totality, of the population. It means the general diffusion of a school-mediated, academy supervised idiom, codified for the requirements of a reasonably precise bureaucratic and technological communication. It is the establishment of an anonymous impersonal society, with mutually sustainable atomised individuals, held together above all by a shared culture of this kind, in place of the previous complex structure of local groups, sustained by folk cultures reproduced locally and idiosyncratically by the micro-groups themselves (Gellner, 1983: 57).

populist or “souverainist”, share hostility against migration, depicted as a threat to security, a burden for welfare, an obstacle to social cohesion and a peril for cultural identity. They also proclaim themselves euro-sceptic and promise to restore national sovereignty.

### **Globalisation: the age of migration**

With the acceleration of the flows of goods, services, ideas, the speed, scale, complexity and volume of migrations also changed (Balan, 2010). In the early Nineties, Mark Miller and Steven Castles spoke of “The Age of migration” (1993), to describe the migratory context at world level. Until the seventies and eighties, migrations were governed by states, representatives of employers’ and trade unions interests (an example of this are the intra- inraeuropean migrations of Greek, Italian, Spanish workers towards Northern European countries). In the global world, it is mainly the global markets governing the migratory flows. This reduces the control of the states on the flows.

Does this mean that the states have abandoned the control of the borders? The states answered in mixed way, with a limited liberation of the labour markets on one side, mostly with the reinforcement of the borders controls. Closing the borders was the common political choice for the rich countries facing massive migrations from the poor “Global South”. The only forms of liberalisation of the labor migration, took place via bilateral agreements and in regional agreements, as in the case of the free movement in the European Union that we have mentioned, or, for some type of workers in the Mercosur in Latin America. In both cases, differences in wages and life conditions were relatively homogeneous or, at least not extreme. Political considerations accompanied these measures.

The contradiction between the markets driven migrations and the states that close the borders, has opened a space to organised crime. According to Ruggiero (1997), globalisation and the opening of markets for goods, services and capital have facilitated the expansion of cross-border organised crime, which has found a new source of profit in smuggling and trafficking of migrants. Migration has become a business for organised crime as smuggling and trafficking. These transnational crimes have raised the concern of the international organisations in a global fight against new forms of slavery. States alone cannot respond to cross border human rights violations. A new legal approach to human rights is consequently developing to face issues raised by globalisation. International human rights law is now based on the idea that the entire global community is responsible for the rights of every individual. Migrants, rejected by the states, can find support in human rights organisations- NGOs, operating at international level. Or, if the NGOs play an important role in defending the migrants’ human rights -they represent another challenge to the states’ remaining sovereignty.

Moreover, the defence of universal human rights would need to be supported by a broad social citizenship. Or social citizenship has been, so far, granted only to the citizens of the nation states (and not all of them, mainly the European ones). The dismantling of the social citizenship in Europe, as a consequence of the introduction of neo-liberal models hasn’t only provoked discontent among the native populations, but also an insane competition between the weaker social categories- poor natives and migrants. In this landscape crossed by

contradictions, The role of supranational organisations, which might have mitigated if not resolved the contradictions of globalisation, have proved to be at best ineffective: at worst, they- as it is the case of the European Union- have sharpened the conflicts, given the uneven distribution of responsibilities among member states in the controlling of the borders of Europe and, more in general, the unequal distribution of power in decision-making processes.

To conclude, in respect to migration, globalisation produced an explosive conflict between free market logics and states' sovereignties - conflict that is mainly suffered by the migrants themselves -pushed away from the peripheral areas towards the core centres of neo-liberal capitalism, smuggled and trafficked, left dying at the borders of the rich world, rejected by the local populations, also victims of the neo-liberal economic model.

### **Migration, the European nation states and the European Union**

Following the Maastricht Treaty in 1992, migration became also an EU issue. The “Europeanisation” of the migratory policies developed around two pillars: the free internal movement, ruled by the Schengen Treaty, and the establishment of an external border, whose custody was mainly delegated to the countries at the outskirts of the continent (Spain, Italy and Greece) through the Dublin Regulation. The physical borders of Spain, Italy and Greece have become the physical borders of Europe, a still inexistent superstate. The Agency Frontex, supposed to help EU Member States and Schengen associated countries manage their external borders and harmonise EU border control, is far from playing any significant role. The European migratory system was always dysfunctional, but it managed to survive until the migratory crisis of 2015 broke out.

The definition of the borders of Europe -combined with the free internal movements- reinforced the division between Europeans and non-Europeans that impacted in a negative way on the possibility to build a multicultural European space, incorporating minorities of different origin. At the same time, the integration policies have been left to the single member states, without proposing a common vision for future Europe, where the migrants would find their place.

In order to avoid a too strong pressure on the border countries (Italy, Spain, Greece), the EU has implemented another strategy, that is the externalisation, the transfer of border management to third countries. Externalisation has been a founding strategy in European policies for a decade now, but, after the refugee crisis, there has been an acceleration in these agreements. Under the pressure of Germany, a readmission agreement has been implemented between the EU and Turkey. In exchange for 6 billion euro to the Erdogan cabinet, the deal ensured that all those who arrived in Greece “illegally” would be returned to Turkey, thus delegating control of Balkan borders to the Turkish authorities.

Besides the violations of the human rights that it has provoked, this agreement (and the huge sums of money given to Turkey) has created resentment in Italy, left alone by the EU, while thousands of sub-sub- Saharan Africans arrived to its shores. This resentment has fuelled the explosion of the so-called populist parties, who won the general elections in 2018. As minister of the Interior, Matteo Salvini focused all the political agenda

on getting back control of the borders of Italy (namely against the NGOs), bringing his party from 17% to 34%!

In front of Salvini's policies, the migratory pressure from sub-sub-Saharan Africa was displaced towards Spain. This trend is not neutral in respect to the recent electoral victories of a right-wing anti-immigrant party as Vox.

In the countries at the border of Europe, the migration crisis has crystallised the resentment against the European Union, unfit to deal with the refugees issue; against the EU failure in assuring the well being of the European people; the mismanagement of the debt crisis; the inexistent intra-European solidarity; the unequal repartition of power, France and Germany playing a sort of directory, which imposes its rules to the others.

### **Conclusions**

The migration crisis has crystallised multiple insecurities of the European citizens, stressed by the everlasting economic crisis with its resulting mounting inequalities; puzzled by the rapid technological and cultural changes affecting work and everyday lives; frightened by the uprooting produced by globalisation processes as delocalisation of activities and jobs. Migration, which nowadays is driven by market forces and escapes to inter-states agreements, is perceived as the symbol of the uprooting risk. The answer to this risk has not been found in the organisation of a supra-national order in which the nation states would share their sovereignty. The process toward a "ever closer Union" as envisioned in the Treaty of Rome has been deeply affected by the economic crisis of 2008 and the migration crisis of 2015, revealing the difficulties to find shared measures, the divisions among the the member states, but also the attachment of the populations to the old nation states. Far-right populists, with their promise to restore 'national sovereignty' in the name of 'the people', have capitalised on these social and cultural insecurities. Opposing national sovereignty to an "out-of-control migration" or an "invasion", in populists' terms- fuels xenophobia and racism. However, populists point out real problems, while offering bad solutions. Supporting the recovery of the state's sovereignty as many European citizens express with their vote, cannot be easily dismissed as nationalism, or, worse, racism. These negative elements do exist, but they are mixed with the reaction to the pressure of imposed changes and the demand for more social protection, that was once assured by the nation states through welfare systems and responsibility towards employment.

The paper starts with a sentence of George Orwell on nationalism and patriotism, suggesting a difference in the individual perception of being part of a cultural and political entity- in a defensive and in an offensive sense. Much of the demand of sovereignty coming from the European voters who choose the populist parties may not be aggressive nationalism, but a demand of a sort of "patriotic protection" of a particular place or a particular way of life (Galli, 2019).

## References

- AEON (2013). You are a citizen of the world. How should you act on that: Available at: <https://aeon.co/essays/you-are-a-citizen-of-the-world-how-should-you-act-on-that>
- Balan, M. (2010). Exchange Market Pressure and De Facto. The Evolution of Demographic Phenomena in Terms of Globalization and Environmental Changes. *Romanian Journal of Economic Forecasting* 13(2): 100-118.
- Bauder, H. (2017). *Migration, Borders, Freedom*. New York, London: Routledge.
- Bauder, H. (2018). Open borders: a utopia? Available at: <https://halshs.archives-ouvertes.fr/halshs-01518746/document>
- Castles, S. and Miller, M J. (1993). *The Age of Migration, International Populations Movement in the Modern World*. New York: Palgrave, Mac Millan.
- Encyclopedia Britannica (2019). Sovereignty. Available at: <https://www.britannica.com/topic/sovereignty/Sovereignty-and-international-law>
- Galli, C. (2019). *Sovranità*. Bologna: Il Mulino.
- Gellner, E. (1983). *Nations and Nationalism*. Ithaca: Cornell University Press.
- Kwameh A. (2007). *Cosmopolitanism, Ethics in a World of Strangers*. New York W. W. Norton & Company.
- Larousse (2019). Nation. Available at: <https://www.larousse.fr/dictionnaires/francais/nation/53859>
- Lumenlearning (2019). Nation states and sovereignty. Available at: <https://courses.lumenlearning.com/boundless-worldhistory/chapter/nation-states-and-sovereignty/>
- Marshall T. H. (1950). *Citizenship and Social Class and Other Essays*. New York: Cambridge University Press.
- Politico (2016). The phrase that haunts Angela Merkel. Available at: <https://www.politico.eu/article/the-phrase-that-haunts-angela-merkel/>
- Ruggiero V. (2017). Global Markets and Crime, in: *Critical Reflections on Transnational Organized Crime, Money Laundering, and Corruption*. Toronto: University of Toronto Press, pp. 171-182.
- Smith, S. (2018). *La ruée vers l'Europe*. Paris: Grasset.
- Voanoticias (2020). 5 millones refugiados venezolanos. Available at: <https://www.voanoticias.com/a/onu-pronosticos-5-millones-refugiados-venezolanos-2020-/5138312.html>

## **6.2. Pro- and anti-migrant mobilisations in polarised Greece: Solidarians, raid battalions, activists, and self-mobilized citizens**

*Theodoros Fouskas<sup>1</sup>*

### **Abstract**

The Greek society received massive flows of immigrants from neighboring Balkan countries, the Republics of the former Soviet Union in the early 90s, as well as significant numbers of immigrants from Africa, the Middle East and Asia in early 2010, while between 2015-2017 mainly refugees from Syria, and currently mixed migration flows (migrants, asylum seekers and refugees). Since 2015, Greece has faced the largest asylum seeker, refugee and migrant flows of recent years, as a dramatic increase was noted (Hatzopoulos et al. 2017; Fouskas & Tsevrenis, 2014). Greece has been the main entry point in Europe for almost a million refugees and migrants seeking security for themselves and their families. The unprecedented asylum seeker, refugee and migrant flows of 2015 coupled with the movement of the migratory route that comes to Greece from Turkey has tested Greece's already overstressed asylum system and has highlighted the weaknesses and difficulties of handling the dramatic rise of migrants and refugees and meeting their humanitarian needs.

**Keywords:** Migrant mobilizations, polarization, refugees

### **Introduction<sup>2</sup>**

The statistics on arrivals of migratory flows across the Greek sea border for the years 2014-2018 are presented in the United Nations High Commissioner for Refugees' data: 41.038 in 2014, 856.723 in 2015, 173.450 in 2016, 29.718 in 2017. Between January and December 2018, a total of 32.494 refugees and migrants arrived in Greece by sea. (UNHCR, 2018a) The majority are from Afghanistan, Syria and Iraq. More than half of the population are women and children, while 40% are men. Arrivals in December 2018, at 2.927 increased in comparison to November, when 2.075 people arrived on the islands. Arrivals during 2018 are 9% higher than those in 2017. Lesbos has received nearly half (46%) of all new arrivals, during 2018, followed by Samos (26%), Dodecanese islands (15%), Chios (12%) and Crete (less than 1%) (UNHCR, 2018b). In statistics regarding foreigners apprehended for irregular entry and stay by the Hellenic Police and Hellenic Coast Guard from 2013 to 2018 show that arrivals in Greece were: in 2013, 43.002 individuals, in 2014, 77.163 individuals, in 2015, 911.471 individuals, in 2016, 204.820 individuals, in 2017, 68.112 individuals, in 2018, 204.820 individuals (first semester) (Hellenic Police, 2018). This demonstrates the pressure on the state mechanism, related services and Greek society in the management of the aforementioned flows, in receiving, identifying,

---

<sup>1</sup> PhD, Sociologist, Campus 1, 28 St. Spyridonos Str., 12243, Egaleo, University of West Attica (UNIWA), Greece, Email: tfouskas@uniwa.gr and Scientific Director of HAPSc, 38 Voukourestiou Str., 10673, Athens, Greece, Email: fouskas@haps.org

<sup>2</sup> This paper is based on results of the research project: Public opinion, mobilizations and policies concerning asylum seekers and refugees in anti-immigrant times (Europe and Belgium) – PUMOMIG, funded by the Belgian Federal Science Policy Office (BELSPO/BRAIN-be). The research was conducted between 2017 and 2019, and coordinated by a research team involving three Belgian universities (ULB, ULiège and KU Leuven), as well as research partners in five European countries: Germany, Sweden, Hungary, Greece and Italy. PUMOMIG's main objective is to gain an in-depth understanding of the factors and social dynamics influencing local attitude polarizations towards refugees and asylum seekers in contemporary societies.



managing, and rendering statutory status etc. The total number of asylum seekers residing in structures under the control of the Greek state amount to about 70.000 people (Ministry of Citizen Protection/National Coordination Center For Border Control, Immigration and Asylum, 2018). According to the updated data of the National Center for Social Solidarity (NCSS), the estimated number of unaccompanied minors in Greece, on 31 December 2018, amounted to 3.741 of which 93.8% were boys and 6.2% girls, while 7.2% is under the age of 14. In both in the islands and the mainland the total number of places in long term accommodation is 1.064, while in temporary accommodation there are 895 (National Center for Social Solidarity (NCSS)/UNISEF, 2018).

According to the official statistical data of the Asylum Service (see Table 1 and Figure 1, December 31, 2018), regarding the number of applications by third-country nationals for asylum within the territory of Greece have more than doubled between 2013-2018. More specifically: In 2013, 4.814 applications with a monthly average of 688 applications, with a percentage difference between 2013-2014 increased at 14,3%. In 2014, 9.431 applications with a monthly average of 786 applications, with a percentage difference between 2014-2015 increased at 39,8%. In 2015, 13.187 applications with a monthly average of 1.099 applications, with a percentage difference between 2015-2016 increased at 287,1%. In 2016, 51.053 applications with at monthly average of 4.254 applications, with a percentage difference between 2016-2017 increased at 14,9%. In 2017, 58.642 applications with a monthly average of 4887 applications, with a percentage difference between 2017-2018 increased at 14,2%. In 2018, 66.970 applications with a monthly average of 5.581 applications. According to the official statistical data of the Asylum Service (see Table 2 and Table 3 and Figure 2, December 31, 2018) regarding the recognition rate of refugee status at 1st Instance procedures: In 2013, the recognition rate of refugee status was 15,5%. In 2014, the recognition rate of refugee status was 28,7%. In 2015, the recognition rate of refugee status was 47,4%. In 2016, the recognition rate of refugee status was 29,1%. In 2017, the recognition rate of refugee status was 46,0%. In 2018, the recognition rate of refugee status was 49,4%. In total between 2013 and 2018 at 1st Instance procedures the recognition rate of refugee status was 43,3%. Moreover, the ten countries of origin with the highest recognition rates are: Syria, Yemen, Palestine, Stateless, Eritrea, Somalia, Afghanistan, Iraq, Sudan, Iran, while the ten countries of origin with the lowest recognition rates are: Georgia, Albania, Pakistan, India, Bangladesh, Algeria, China, Egypt, Nigeria, Morocco (see Table 2 and Table 4 and Figure 3, December 31, 2018).

**Table 1: Asylum Applications (2013-2018)**

	2013	Difference % (2013-2014)	2014	Difference % (2014-2015)	2015	Difference % (2015-2016)	2016	Difference % (2016-2017)	2017	Difference % (2017-2018)	2018	Total
<b>Total</b>	<b>4814</b>		<b>9431</b>		<b>13187</b>		<b>51053</b>		<b>58642</b>		<b>66970</b>	<b>204097</b>
Monthly average	688	14,3%	786	39,8%	1099	287,1%	4254	14,9%	4887	14,2%	5581	3046

Source: GreekAsylum Service, 2018.

Figure 1: Applications by year (2013-2018)

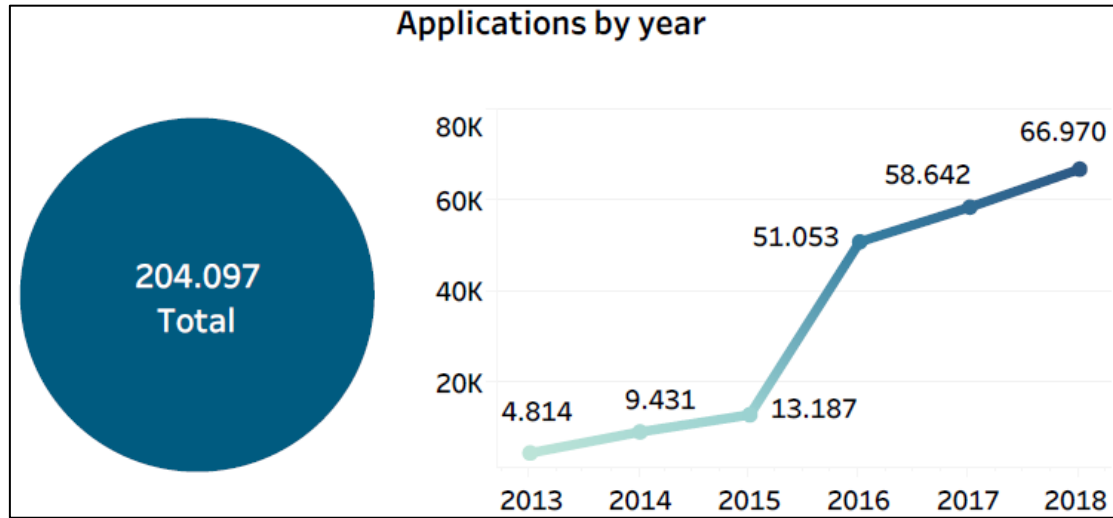

Source: Greek Asylum Service, 2018.

Table 2: Asylum Applications - Countries of Origin (2013-2018)

	2013	2014	2015	2016	2017	December 2018	2018	Total	%		2013
Syria	252	773	3490	26677	16398	519	13390	60980	29,9%	Syria	252
Afghanistan	803	1709	1720	4362	7566	1334	11926	28086	13,8%	Afghanistan	803
Pakistan	610	1618	1822	4692	8922	581	7743	25407	12,4%	Pakistan	610
Iraq	107	174	661	4810	7920	671	9731	23403	11,5%	Iraq	107
Albania	419	569	1003	1420	2450	242	3319	9180	4,5%	Albania	419
Turkey	17	41	42	189	1826	409	4834	6949	3,4%	Turkey	17
Bangladesh	230	633	738	1215	1383	132	1552	5751	2,8%	Bangladesh	230
Iran	131	361	241	1096	1316	175	1763	4908	2,4%	Iran	131
Georgia	342	350	386	687	1107	136	1461	4333	2,1%	Georgia	342
Palestine	17	74	60	850	1304	226	1519	3824	1,9%	Palestine	17
Other countries	1886	3129	3024	5055	8450	785	9732	31276	15,3%	Other countries	1886

Source: Greek Asylum Service, 2018.

Table 3: 1st Instance Procedures(2013-2018)

	2013	2014	2015	2016	2017	December 2018	2018	Total
<b>Refugee Status</b>	229	1223	3647	2451	9306	986	12626	<b>29482</b>
<b>Subsidiary Protection</b>	93	487	347	249	1045	211	2579	<b>4800</b>
<b>Negative in substance</b>	1754	4254	4434	6586	12138	1161	15563	<b>44728</b>
<b>Inadmissible decisions</b>				15232	22450	269	4842	
<b>a) due to the application of the safe third country principle (Border Procedures)</b>				1305	912	1	400	
<b>b) due to acceptance by another Member State (Dublin Regulation procedures)</b>	261	1453	2019	2069	8297	180	3242	<b>46257</b>
<b>c) due to acceptance by another Member State (Relocation procedures)</b>				11000	12316		33	
<b>d) on subsequent (repeated) applications</b>				774	915	86	1158	

e) due to administrative reasons				84	10	2	9	
Implicit & Explicit withdrawals <sup>3</sup>	243	1078	2373	2389	6681	1022	10713	23472
<b>Total</b>	<b>2580</b>	<b>8495</b>	<b>12820</b>	<b>26907</b>	<b>51620</b>	<b>3649</b>	<b>46323</b>	<b>148739</b>
Monthly average	369	708	1068	2242	4302		3860	2220
Recognition Rate (%) <sup>4</sup>	15,5%	28,7%	47,4%	29,1%	46,0%	50,8%	49,4%	43,3%

Source: Greek Asylum Service, 2018.

**Figure 2: Decisions in substance from 2013 to 2018**

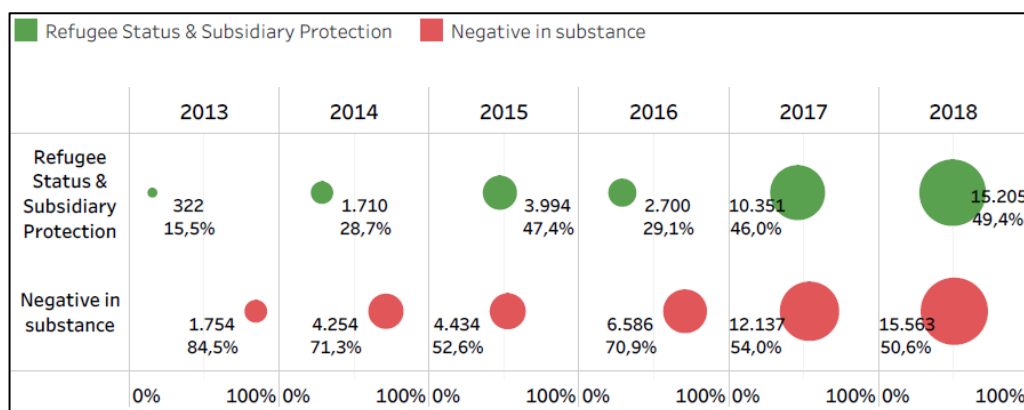

Source: Greek Asylum Service, 2018

**Table 4: 1st Instance Procedures - Recognition Rates (%) (Countries with more than 300 Decisions in substance)**

10 Countries of Origin with the highest recognition rates		10 Countries of Origin with the lowest recognition rates	
SYRIA	99,6%	GEORGIA	0,0%
YEMEN	98,9%	ALBANIA	0,2%
PALESTINE	96,8%	PAKISTAN	2,5%
STATELESS	89,8%	INDIA	2,6%
ERITREA	87,4%	BANGLADESH	3,3%
SOMALIA	84,6%	ALGERIA	3,5%
AFGHANISTAN	70,9%	CHINA	8,0%
IRAQ	69,4%	EGYPT	8,6%
SUDAN	60,8%	NIGERIA	12,1%
IRAN	60,2%	MOROCCO	13,3%

Source: Greek Asylum Service, 2018.

<sup>3</sup> This category includes withdrawals that have not been revoked.

<sup>4</sup> Calculation based only on decisions in substance (Refugee Status, Subsidiary Protection, Negative in substance).

**Figure 3: Recognition rate**

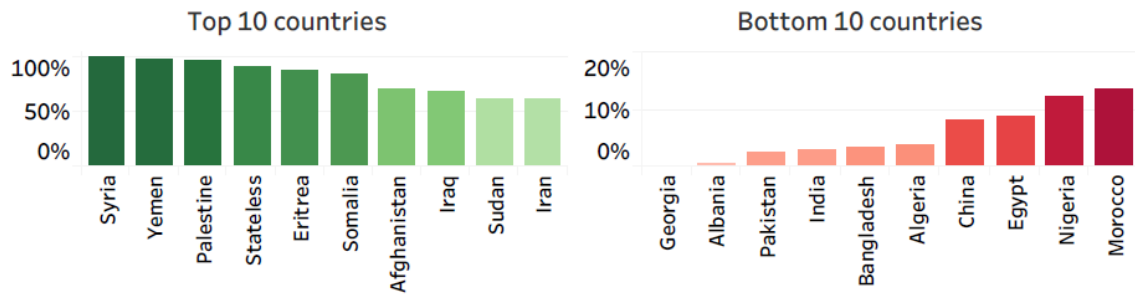

Source: Greek Asylum Service, 2018.

The shocking photo of the drowned Syrian refugee child washed-up on the shores of Turkey in September 2015 (Smith, 2015), as well as of the hundreds of lives lost at sea in the Mediterranean due to capsized boats overloaded with refugees have brought the migration and refugee crisis to the world’s attention (IOM, 2017). Alarming, immigrants, asylum seekers and refugees are overwhelmingly opting for treacherous overseas routes, the Greek-Turkish borderline being the most popular. On the one hand, social discourse regarding solidarity, support and humanitarianism have been widespread in European countries, including Greece, but on the other hand, immigrants, asylum seekers and refugees have often been seen as “unwanted individuals” or as a “threat”.

The abovementioned contradiction on the perceptions and practices towards immigrants, asylum seekers and refugees, in the case of Greece is evident in the period 2015-2018. On the Greek islands e.g. in Lesbos, on the one hand the unconditional care and response on behalf of the society, local societies and communities, the civil society and the actions/acts of solidarity of Greek citizens towards the incoming populations, is extremely important and extensive, particularly during 2015, where the refugee and migrant flows increased significantly. This warm reception was exceptional, at European and international level, to a global issue. Greek fishermen conducted multiple rescues on a daily basis. The citizens not only collectively, via collective and organized/coordinated actions and awareness raising/sensitization campaigns, but also via individual initiatives, have shown outstanding solidarity and support to the refugees by providing every possible form of assistance and care. Citizens, professionals of all specialties, medical doctors, teachers, students, entrepreneurs et al., have taken and continue to take initiatives in order to provide humanitarian assistance to every region of the country (Imerisia, 2015). On the other hand, in November 2017, residents on the Greek island of Lesbos went on strike to protest against European policies they say have turned their island into a “prison” (Kathimerini, 2017) for immigrants, asylum seekers and unrecognized/pending status as refugees/applicants for international/humanitarian protection.

Golden Dawn (GD) is neither an unanticipated nor a novel phenomenon but rather part of a historical continuity of various far-right and anti-immigrant remnants of the military junta in Greece that survived the restoration of Democracy in 1974. GD was founded in the early 1980s by N. Michaloliakos as a neo-Nazi, antisemitic

organization. Its action developed in the early 1990s and since then dozens of violent attacks have been launched against both migrants, and Greeks. Its representatives have been systematically identified as nationalists with references to Nazism. GD is considered a fascist and neo-Nazi organization on the basis of its symbols, historical references, and ideology. It has been accused of extremist action, racist violence, and murderous attacks. GD's pre-2015 activity had begun to build its profile in the neighborhoods of Athens with the economic recession along with the fall of the old political system and incoming populations of asylum seekers, refugees, and migrants used to pave the way to its rise. Its aim was to ultimately be represented in parliament as a political party by attracting electorates from other parties, while escalating its visible violence and neo-fascist character. GD is not only defined by its far-right ideology but also by its ability to successfully manipulate feelings of hatred and fear that migrants are faced with by sections of the Greek society.

This paper focuses on mobilizations concerning migrants, asylum seekers and refugees in Greece<sup>5</sup>. It describes pro-migrant and anti-migrant citizen mobilizations, highlights how these mobilizations have evolved over the last three years (2015-2018) and what has triggered and influenced those social movements of solidarity and hostility.

### **International research literature on pro-migrant and anti-migrant mobilization in Greece**

International research literature has focused on solidarity to migrants, asylum seekers and pro-migrant self-organized grassroots initiatives, as well as on extreme/far-right GD and anti-migrant initiatives. Regarding pro-migrant mobilizations: Rozakou (2012) identified tension between the humanitarian and the political production of the asylum seeker-refugee in contemporary refugee management. Papataxiarchis (2016a) mentioned that "For the 'solidarians', being there is part of a utopian project: making a self-organized collectivity built on 'solidarity' and 'horizontal' – bringing together people from all different quarters in order to stand by the refugees with 'dignity'" (Papataxiarchis, 2016b: 7). Rozakou (2016) addressed solidarity and the opening of social spaces in the relations between refugees and residents of Greece who tried to help them in 2015 in Lesbos. Serntedakis (2017) mentioned that numerous humanitarian organizations and self-organized grassroots initiatives were employed in the field, providing assistance to the newcomers. Rozakou (2018a) mentions that the volunteers of two organizations were in many ways pioneers who, out of love and solidarity, supported refugees. Oikonomakis (2018) noted the fact that the solidarity that the Greek people and the refugee solidarity movement, showed that the moving populations was subject to a triple transition and that it depended heavily on the changing political context. Rozakou (2018b) focuses on the case of a group of solidarians who visited the detainees in a pre-removal center as well as other 'solidarity initiatives' and the materialization of solidarity in everyday life and its radicalization.

---

<sup>5</sup> The research was compiled under the research project: Public opinion, mobilizations and policies concerning asylum seekers and refugees in anti-immigrant times (Europe and Belgium) – PUMOMIG, funded by the Belgian Federal Science Policy Office (BELSPO/BRAIN-be) (BR/175/A5/PUMOMIG).

Knott (2018) focused on the figure of the volunteer on the islands of Lesbos and Chios, as an emergent humanitarian actor in border regions, to highlight issues in the way hospitality is currently being extended by one group of guests to another. Cabot (2018) mentioned that what was most striking was the scale of the response of Greeks and other locals on the ground, through the mobilization of informal, but highly organized networks based on the principle of “solidarity” with refugees. Regarding anti-migrant mobilizations: Kandyliis and Kavoulakos (2011) mention that local anti-immigration actions in the Greek capital seemed to deepen the wider racist discourse against immigrants. Ellinas (2013) underlined that GD’s violent tactics have allowed the party to establish an anti-system and anti-immigrant profile and capitalize on these sentiments. Koronaiou and Sakellariou (2013) analyzed GD’s main publicized activities including helping Greek people in the community facing increasingly serious problems in many aspects of their daily lives as a result of the economic crisis. Psarras (2014) noted the economic and financial crisis, as well as the extreme social repercussions that have occurred in Greece since 2010, paved the way for the rise of the Greek neo-Nazis. Sakellariou (2015) mentioned that young people feel attracted by GD’s right-wing ideology and share the party’s racist stance vis-à-vis immigrants and other groups. Petrou and Kandyliis (2016) highlighted that an everyday rhetoric gives GD a privileged position in the spread of violence. Lazaridis and Skleparis (2016) emphasized that extreme securitizing perceptions of security professionals have been exploited and assisted by far-right extremist groups, which instilled racial violence, hate speech/crime into society. Lazaridis and Veikou (2017) focused on the far right in Greece and discrimination, hate speech, and hate crime against the ‘others’ from the perspectives of those who are active in mobilizing against racism and counteracting the country’s populist and neo-nationalist turn. Ovenden (2018) outlined the modus operandi of GD’s leadership uses to eliminate their rivals, often by violent means.

## **Methodology**

Research methodology is based on the examination of citizen mobilizations that have emerged since 2015. From 05/01 to 11/01/2018, 38 in-depth interviews in Greek were conducted in Greece (Table 5). Purposive sampling was used with members of organized initiatives, civil society organizations and activists, mobilized citizens, and mobilized migrants who contributed to the research in various ways during the period 2015-2018. The interviews were conducted using snowball sampling, according to which every research participant directed the researcher to organized initiatives or other mobilized citizens from his/her broader network. Total anonymity and confidentiality were guaranteed via a consent form. Interviews oscillated to saturation point and a semi-structured interview guide with three sections was used to collect the qualitative material. Creating codes for data summarized and classified similar phenomena and emphasized their frequency, intensity and similarity. By these means, it became possible to identify the interviewees’ reasons, perceptions, strategies and practices.

**Table 5: Research sample**

Anti-Fascist Coordination of Athens-Piraeus	Athens	1		
Anti-Nazi Zone				
ANTIGONE	Thessaloniki	1		
Antiracist Initiative of Thessaloniki				
ASANTE	Athens	1		
Municipality of Athens				
Generation 2.0 RED				
Golden Dawn Watch				
Observatory on the Fascist and Racist Speech in the Media				
Greek Forum of Migrants				
Greek Forum of Refugees				
Melissa Network of Migrant Women in Greece				
Mobilized citizen			Crete	2
			Athens	15
			Lesvos	2
	Chios	1		
Movement Expel Racism	Patras	2		
Movement Expel Racism	Athens	1		
Migrants' Sunday School				
Network for the Political and Social Rights				
Network for the Social Support to Refugees and Migrants				
Racist Violence Recording				
United Movement Against Racism and the Fascist Threat				
Pikpa Camp	Lesvos	1		
FEOX	Chios	1		

### **Solidarians, raid battalions, activists, and self-mobilized citizens**

Greece has been deeply affected by overwhelming flows of refugees and migrants since 2015. Despite the financial difficulties that the country faces, the Greek people showed solidarity to the incoming populations. Citizen contributions e.g. fishermen who were saving refugees from drowning in the Aegean Sea, municipalities and regional authorities, numerous national/international non-governmental organizations and international organizations have also contributed. The Greek Church was in a dilemma but contributed as well. Apart from numerous citizen initiatives and volunteering, squatting in uninhabited buildings and self-management initiatives, assisting refugees, asylum seekers and migrants that pre-existed the “refugee/migrant crisis” in 2015 in the city centers, towns or public areas, in neighborhoods in the mainland e.g. Victoria Square, Pedion of Areos, and in the Greek islands e.g. The Hug in Lesvos, Pikpa Camp and Mosaik Support Center (Lesvos Solidarity) in Lesvos, Leros Solidarity Network, Kos Solidarity, Lathra; and FEOX Rescue Team in Chios, in Idomeni and other areas, recently mobilized citizen initiatives have materialized, supporting migrants/refugees by providing clothes, shoes, food, setting up “solidarity kitchens” offering meals,

medication, financial support, blankets as well as squatting in uninhabited buildings to house migrants and refugees, more self-organized, grassroots initiatives based on open assembly initiatives emerged in terms of solidarity by Greeks and foreigners like local activist groups, open autonomous social spaces that are functioning under self-organization and “horizontal” collaboration based on the belief that solidarity is the only appropriate response to the refugee/migrant crisis. They perform various activities: they cook and collect basic essentials, long-life food, cleaning and personal hygiene items, baby food (long-life milk, biscuits and croissants), baby bottles and baby diapers, bottled water, disinfectants and various health items.

They provide support, solidarity, safety and empowerment towards integration and are supported by donations and the work of volunteer activists in order to store and arrange donations, cleaning rooms, preparing and serving meals, medical doctors, e.g. pediatricians and physicians, nurses, translators, psychologists and social workers, vehicles for transportation of items or people. They move beyond the crisis and apart from food, housing, and everyday needs they offer sustainable structures to support refugees in their resolve to live in dignity e.g. legal support for asylum applicants, psychological support, vocational training, training in arts and crafts, workshops, music and dance classes, daycare for young children, cultural events supported by artists, activists and organizations from across the world. The City Plaza Refugee Accommodation Center is a self-organized housing project for homeless refugees in the center of Athens that accommodates 400 people, among them 180 children. It is a 7-floor abandoned hotel, which had remained vacant for 7 years until it was squatted by activists and refugees in late April 2016. It is based on principles of self-organization and political autonomy and depends entirely on the support and practical solidarity from within Greece and abroad. It functions through different working groups for cleaning, cooking, security, logistics, education and childcare, medical care, media-work, reception, which answer to the regular assemblies of refugees and solidarians/people who exhibit solidarity. FEOX Rescue Team is a certified and registered volunteer organization. Since summer 2015, FEOX has handled many precarious landings on some very rocky landing spots. Besides supporting individuals in Souda with basic needs from a well-equipped warehouse, other activities with the use of the appropriate equipment include: (i) Movie nights in Souda/Vial, (ii) Summer activities in the park, (iii) Supervised excursion trips all over Chios for refugee friends and volunteers alike, by trained and certified professionals, (iv) Search and rescue, (v) Ensuring safe and dignified landings with full permission to operate by the Hellenic Coast Guards. Since 2015 the main focus of Golden Dawn Watch is the continuous monitoring, which results in the publication, after each trial day of a summary report, translated into English, in order to inform the international public, the publication at regular intervals of a review of Greek press reports on the GD trial, to be carried out by a working group of the Observatory on the Fascist and Racist Speech in the Media. GDW’s team believes that only a well-informed and sensitized public can develop strong resistances against the spread of racism, fascism and neo-Nazism, and ultimately to fear. Kos Solidarity an independent movement of citizens of Kos since 2015. Pikpa Leros was a hospital converted into a refugee reception center with the support of Leros Solidarity Network, which since 2016 offers “safe, warm and cosy accommodation to vulnerable families, the elderly, handicapped, unaccompanied minors and pregnant women”. Pikpa Leros also provides



rooms with heat, showers, utility rooms, playroom and a kitchen. Lesvos Solidarity (former PIKPA camp) was a response to the urgent need for shelter and basic support, the group took the initiative to start housing refugees on the site of PIKPA. In 2012, solidarity network “The Village of Altogether” was formed and the group started offering accommodation to refugees on the site of PIKPA. From 2015 onwards PIKPA camp started hosting the most vulnerable refugees on the island. It provides accommodation/shelter, clothes/food, medical care, psychosocial support, legal support, school and educational activities, events and other activities.

After the prosecution of its leadership and the opening of the trial, GD had to temporarily withdraw the raid battalions from the streets, resulting in a drastic reduction of the attacks. There is a reduction in incidents recorded by organized groups, mainly following the prosecution of the GD members and the adjudication of related cases. However, organized violence has not disappeared, regardless of whether the mode of operation and/or frequency is changing. A common feature is the choice of victims due to their migrant background and the offensive planned attacks by the perpetrators. Small neo-Nazi organizations and groups that copy the GD’s paramilitary action, its Nazi constitution, structure, slogans and phraseology attempt to cover this gap. However, there are ongoing racist acts e.g. a large group of civilians led right-wing members and organized football fans who attack groups of refugees, mainly from Afghanistan, who had squatted Sappho Square in Mytilene of Lesvos (April 2018). In recent years, GD has used social media platforms to spread its ideas.

Since 2015, mobilized citizens, anti-racist/ant-fascist networks, migrant community associations and civil society organizations have staged protests and taken actions against racist and fascist attacks against migrants, asylum seekers, refugees or have mobilized citizens on humanitarian claims, e.g. against the closure of borders, against the construction of camps, against inhumane living conditions of asylum seekers in camps (e.g. Moria in Lesvos, Vial in Chios et al.), against deportations, in favor of faster access to asylum (calls to protest, distributing flyers and posters). These protests coexist with practical solidarity towards refugees taking the initiative to collect and instantly deliver e.g. clothes, shoes, blankets, essentials for babies like diapers, health and food products such as milk, baby creams, water, nuts, juices, croissants and biscuits, gather donations and manage the distribution of goods. Apart from anti-racist and antifascist demonstrations the Annual Antiracist Festival in Athens is organized by related initiatives. It usually hosts a number of discussions, concerts, as well as stalls selling edibles from multicultural cuisine. Anti-racist festivals also take place in other cities of Greece e.g. Thessaloniki, Chania or Rethymnon of Crete. Distribute informative flyers, organize talks and demonstrations. In some cases, there are also protests of refugees/asylum seekers or migrants in urban centers and on the islands. The mobilizations, solidarity gatherings and demonstrations are against fascists and neo-Nazis, expressing solidarity towards refugees and migrants. Often there are also anti-imperialist demands. The mobilizations are organized by left and/or radical left and/or non-parliamentary left and/or anarchist initiatives, collectivities, unions, anti-fascist movements and initiatives, student associations, organizations and bodies, who organize marches towards the Parliament, Ministries, EU offices, Embassies, City Halls and local government offices. Anti-fascist rallies in various cities take places against the intolerant and racist voices, protests for the drowning of refugees in the Mediterranean, for hunger strikers, responses by anti-racist and

anti-fascist organizations and collectivities against the racist gatherings by nationalists against refugee children's schooling, Pan-Hellenic days of action for the GD Trial, days of solidarity events. Some of the slogans during the demonstrations are: "Open borders and grant asylum to refugees!", "Refugees Welcome", "A quick death in Syria, a slow death in Europe", "NATO, USA, EU, Government spread Wars-Poverty-Expulsions. Refugees and Migrants are welcome", "Solidarity to Migrants. In a world of bosses we are all foreigners", "Solidarity to all Refugees", "No to EU-Turkey deal-No to prison-islands", "Let's break the isolation of concentration camps", "Against borders-war-racism. Solidarity with refugees", "Solidarity-resistance-self-organization everywhere", "Fascists get out of our neighborhoods", "Fascism will not prevail", "Golden Dawn murderers-neo Nazis must be imprisoned", "Solidarity to refugees. No to islamophobia", "Stop fascism", "Pavlos lives-Crush the Nazis", "Refugees IN: Welcomed - Neo-Nazis of Golden Dawn-Out", "Refugees are welcomed, destroy the fences, NATO out", "Let's erase the Nazis all together".

There are ongoing acts against migrants and refugees by various groups. These groups, e.g. committees of parents, shop owners, local media representatives, residents et al that according to interviewees express anti-migrant sentiments and show intolerance to third-country nationals' stay on the islands (e.g. Panchialki Committee of Action) or in the city centers, in some cases might be connected to or motivated by GD, or even schools (e.g. Lamia, Chios, Oreokastro, Polygiros, et al.), city councils against the accommodation of refugees in their city (e.g. Messolongi, Larissa, Kavala et al.). However, the anti-fascist group was active and dealt with such phenomena, although the anti-migrant initiatives are still active too. In Greece the anti-migration, racist and extreme-right political party GD is active, although it has remained on the side-lines of Greek politics since 2012, receiving a high percentage of electoral votes. Also, since 2015, GD has been organizing open protests against migrants and refugees. In most cases the anti-fascist movement managed to stop their events. Moreover, their activity has been severally reduced after multiple violent incidents e.g. GD spokesman I. Kasidiaris slapped Communist Party's MP L. Kanelli (2012), Shehzad Luqman's murder (2013), murder of P. Fyssas (2013) that led the Hellenic Police to raid various GD offices in Athens, leading anti-fascist supporters and leftists marching against racist and fascist attacks. An ongoing investigation has since confirmed that the alleged perpetrator was in contact with GD members prior to and at the time of his murder. A subsequent police crackdown led to raids on GD offices and the arrests of several party members, including the Party leader, who was imprisoned as a result of owning the office phone to which a telephone call alleged to be associated with the murder, was received. During April 2016, GD supporters, came into conflict with supporters of refugees in Piraeus and in Chios. Following an investigation into Fyssas's murder by a supporter of the party, the Secretary General and several other GD MPs, cadres and members were arrested and on suspicion of setting-up a criminal organization they were held in pre-trial detention. The trial began on April 20, 2015 and is ongoing as of 2018. In Greece the increasingly polarized atmosphere due to the economic recession, taxation, high unemployment rates or precarious labor, coexisting with the "refugee/migrant crisis", between 2012-2013, GD had tried to act as "Robin Hood" in areas with high-migration by distributing food for "Greeks only" while also organizing events on Greek national anniversaries via the "Committee of National

Memory”. Many interviewees insist that the fight against Nazism and neo-fascism is not over and that GD, although unable to influence the social discourse in Greece on refugees, asylum seekers and migration and is politically isolated is making continuous efforts to retain and expand its electoral ground via nationalistic student protests against the FYROM name agreement of Prespes and to spread its ideas. However, local and school societies and mobilized citizens are active in their efforts to ban nationalist and extreme-right ideas of GD.

However, the ongoing situation of uncertainty (limbo), helplessness and entrapment in squalid conditions of migrants/asylum seekers in the mainland and on the Greek islands, also allows room for acts of racism e.g. in December 2018 in Mytilene, where a Bangladeshi migrant who was helping customers of a super-market to transfer their purchases to their vehicles and then, after gaining permission collected the coin from the cart, was violently attacked. On December 8, 2018 he told a customer not to park his car in the area reserved for individuals with disabilities; the customer of Greek origin violently attacked the Bangladeshi migrant verbally and also seriously injured him with a metal rod that he had in his vehicle. GD and local branches all over Greece, or other nationalist initiatives under it (e.g. National Coordinating Body, Non-aligned Meandrian Nationalists et al.) organize mobilizations in central urban centers, and demonstrations against e.g., the construction of mosques for Islamic illegal migrants in September 2018, events on the accusation and trial and the characterization of the procedures as illegal in October 2018, events in memory of young nationalists who were murdered in New Heraklion in 2013, as GD presented its candidates for the Municipalities and the Region of Attica in December 2018. The main slogans of GD are: “Blood, honor, Golden Dawn”, “We want our neighborhoods back!”, “Katsifas lives and leads us”, “Macedonia is Greek land. Golden Dawn”, “Illegal migrants out”.

Pre-existing organizations played a crucial role in pro-migrant mobilizations and there was immediate response in terms of support and solidarity to refugees, asylum seekers and migrants. Pre-existing organizations mobilized the collection and distribution of items of necessity such as clothing and supplies (sleeping bags, children’s raincoats, thermal blankets and items for baby care, etc.) food, personal hygiene items (from baby wipes and diapers, to soap and toothbrushes), as well as medicines. Pre-existing organizations worked simultaneously and had already paved the way for collective, self-organized, grassroots pro-migrant mobilizations and practical solidarity. The pre-existing solidarity movement helped to set up various working groups to meet everyday needs and actions such as soup kitchens, clothes, information teams, health teams, advice on cleanliness, groups that engaged in activities for children and were active not only in urban centers but also on the Greek islands. GD’s pre-existing actions had begun to build its profile in neighborhoods and pave the way during the economic recession along with the fall of the old political system and incoming populations of asylum seekers, refugees and migrants, to be elected by attracting electorates from other parties, while escalating its visible violence and neo-fascist character.

The profile of the mobilized citizens of pro-migrant mobilizations, according to the interviewees, could be both political activists or citizens with no previous political experiences. From the interviewees, the majority were the latter, but over time those who still endure and continue, from the aftermath of the 2015-2016 period, are those individuals who are considered political activists. Interviewee GR3, Antiracist Initiative of Thessaloniki, added:

*We have both profiles. Both have an interest in it when one category evolves into the other; that is to say, when a political activist who comes to the anti-racist movement based on political positions that say migrants are brothers/sisters of the working class and so must be with them, thus manages to indulge some of the particularities of the space and not to treat it in an ideological way. Respectively, a man who comes as a solidarity citizen who is not very interested in politics and simply wants to help his fellow man by going into the process of helping, slowly understands the political causes, the political conditions around these situations. So, they both have profiles, that is to say, politicized people on the one hand and on the other people who come to help without starting from a political belief, but what we want and what interests us is that these two converge and blend with each other. There is no specific profile. What made someone get up off his/her sofa, was that he/she from his/her house was watching a tragedy, I'm not going to refer to Aylan; before and after Aylan many other children, families, men and women were lost. A part of those people who are active, in the 2015 solidarity movement, as I understand, a part was already actively involved in the anti-racist movement and in movements in general; they were political activists of the Left in the anarchist sector.*

Interviewee GR28, Mobilized citizen, Chios, stated:

*No, the majority of those who have been mobilized, even if they were politically positive, would not go beyond it, politicize it. [Currently, there is a crisis in the solidarity movement across Europe]. There is a general crisis now, not just in solidarity but in all issues. There is fatigue. Yes, there is a little, at least in Greece. After 2015, after the referendum and all these things that happened, there were a lot of people who just gave up because they thought they had no alternative. "There is no alternative", imbued and passed, so why fight, why try? There were people who became passive, who used to be politically active but were deactivated and disappointed because SYRIZA had led them to some extent, and suddenly they were dropped like a hot cake. Lathra; I think was afraid of opening up. Solidarians/people who exhibit solidarity, because it was a group that was set up on tension has never been able to discuss, process, politicize beyond ad hoc their actions. There is fatigue, there are other priorities. There is always a core of X number of people, but one-two pull, give the slogan, take the initiative and not only in Chios, all over Greece and everywhere, I think. So, if these people for whatever reason become inactive, then so is the rest.*

There were citizens who expressed practical solidarity e.g. offered clothes, shoes etc. but did not join in on the migrant mobilizations as they wanted someone else carry out the next steps and deal with the issue. A categorization of solidarity forms emerges from the interviews. A more visible category, such as an umbrella, e.g. an Anti-racist Initiative, that there is another that is under the umbrella of such initiatives, e.g. of a group

of initiatives. And then there is the individual, who is politically active and participates and also the person, who is not politically active. From an umbrella initiative, which is more coordinated in the form of a network, like an Anti-racist Initiative, then to a form that is more active such as a group which can help gather food, clothes, and there are people, the most politically active ones and the ones who are not politically active at all. The profile of the citizen of anti-migrant mobilizations associated with Golden Dawn, as described by the interviewees, is an individual with beliefs characterized by intolerance. Moreover, the majority are misled voters. Most pro-migrant mobilizations operate without leadership and hierarchy, but on a voluntary open assembly. However, often those who had initiated the action could be a member of left radical movements and left-unities, in short networks of the radical left. Anti-migrant mobilizations have an organizational structure, follow a leadership and hierarchy even a specific formation when protesting against migration e.g. GD activists walk in paramilitary formation.

In many cases those citizens who were strongly mobilized in pro-migrant mobilizations did have links to the Greek Left, self-organizational and solidarity initiatives left radical movements and networks for the radical left. For example, SYRIZA as an opposition party and its members used to be in constant contact and have open corridors of communication and supported anti-racist initiatives. However, for the mobilized citizens of pro-migrant actions this changed after the referendum of 2015, and the acceptance of Greece EU-Turkey Statement of March 18, 2016 by SYRIZA as the governing party (with ANEL). The other political stakeholders did not seek to promote or cooperate with them. Regarding NGOs, there are co-operations and exchange of support in many cases but mobilized citizens differentiate themselves from NGOs in that they actually have a non-profit character and receive contributions only from those who are similar. Political stakeholders compete on the electoral pool of GD. Many political stakeholders tried to express their views in public in an attempt to approach their electorate while trying to isolate GD, but with little effect. NGOs have never sought any collaboration with GD.

The main volume of the initiatives of the solidarity movement takes place in urban centers of large cities in Greece but not as many as take place on the islands with important numbers of incoming populations and even less in rural areas. The collectivities are calling for gatherings: anti-fascist co-ordinations of various cities in the country, anti-fascist initiatives, open spaces, anti-racism movements, migrant community associations and organizations, refugee-migrant co-ordinations. These gatherings are often supported by anarchist initiatives which also participate, trade union initiatives, anti-authoritarian movements of various cities, left radical movements and left-unities, networks for the radical left, organizations of revolutionary youths. GD has activities that take place not only in city centers but all over Greece.

The mobilized citizens of pro-migrant activities emerged when support and assistance was needed. It is based on the feeling of unity between people who associate them with common interests, goals or challenges. At the same time solidarity to refugees, asylum seekers and migrants emerged because the state mechanism was unable to act swiftly and decisively against the climate of anxiety or fear that the media cultivated. After the

2015-2016 period some pro-migrant mobilizations took a legal form as NGOs in order to manage the possible sources more effectively and continue their activities. However, some mobilized citizens who were political activists kept going until 2018, exhausted and died out. Some chose to take a break in order to recharge their batteries and distance themselves a while from the ongoing dramatic experiences that they had witnessed. Also, the majority of mobilized citizens with no previous political experiences or those outside self-organized, grassroots and solidarity initiatives, stepped back. In addition, some pro-migrant mobilizations changed activities and adapted to the current ongoing situation e.g. FEOX Rescue Chios changed its activity. At the same time other pro-migrant mobilizations continued their activities, beyond the “refugee/migrant crisis” on other issues e.g. migrant and refugee dealing with immobility/limbo and/or integration. Despite the ongoing court case, GD continues its long-standing anti-migrant action until today. GD members show uninterrupted commitment to their leader and to GD itself. In addition, in December 2018 its new candidates for municipal elections of 2019 were presented. At the same time there were threats e.g. against tenants in buildings that hosted refugees, where a raid battalion of GD activists threatened passengers at Monastiraki train station, and there have been threats of clashes by GD who rally against the squatting of schools.

## Conclusion

Pro-migrant mobilizations have retained their characteristics, are still active but adapted their role and initiatives to the current situation of managing immobility/limbo for men, women, children and families and/or their integration. Many interviewees mentioned that the solidarity movement is present but not at the same intensity and is standing by until it is needed again. The situation has changed, and one has to deal with everyday needs of migrants, asylum seekers and refugees for an unspecified time, an uncertain period of awaiting a decision for asylum or resolution and an in intermediate state or condition. In most cases mobilized citizens who were political activists, contributed in 2015 and kept going until 2018 stepped back temporarily. Moreover, mobilized citizens with no previous political experiences (e.g. who volunteered for a short time) or those outside self-organized, grassroots and solidarity initiatives who just contributed during a specific time, place and means (e.g. by offering clothes, food etc.) have currently distanced themselves completely or indefinitely, according to many interviewees. It was his/her disappointment and the continuous, irreversible situation that had an emergency character but became permanent due to insufficient solutions by the Greek government and the European Union. Interviewee GR28, Mobilized citizen, Chios, explained:

*First of all, we got used to [the situation of refugee/migrant flows]. Secondly, it is not in plain sight anymore. That is to say, in 2015 the vessels arrived on the beach or docked at the harbor. In 2015, for example, there were two cases which I know of, that took place in our area. When the vessel arrived the phone rang at 3:00 am and every able bodied person rushed down to offer dry clothes and to give them something to drink and eat. Now this has stopped because they are picked up and transferred directly to the harbor. The hotspot in Vial is fully functional, so we do not have such cases now; there is the hotspot in Vial and also apartments for*

*those who live in apartments. The immediacy is lost and you do not see them. If you go to Samos in summer, you go to the beach and you see refugees. Here in Chios, you do not see them if you walk around on the island.*

Regarding professionalization, some mentioned that NGOs professionalized the migration/refugee issue, in a form of “NGOization” of solidarity, something that is different from the pro-migrant mobilizations based on solidarity, self-organization and grassroots initiatives. However, in some cases volunteers after some years had to become employees of a solidarity initiative as its status changed in order to deal with various sources as the initiatives needed to respond better to the necessities. Generally, most believe that there is no professionalization of citizen movements. Concerning politicization of the citizen movements, most interviewees mentioned that politicization existed in effect from the beginning via those who are political activists. There is no further politicization of the movements. In some cases, some citizens with no previous political experiences became more politicized after their involvement and contribution. GD’s professionalization emerged after the civil lawsuit. GD, after entering Parliament, gained access to state funding. However, an important source of funding for the organization was the sale of clothes and materials that were considered to be linked to GD; another a major source of revenue was the protection services offered by members of the organization to shops and bars. Concerning politicization, GD uses a far-right-wing populism i.e. opposition to migration and to the Islamic world, Euroscepticism, neo-nationalism, anti-globalization, nativism, protectionism. Pro-migrant citizen mobilizations are addressed to individuals who are in need of support and to the rise of anti-migrant mobilizations. Both, pro-migrant citizen mobilizations and anti-migrant citizen mobilizations are influenced by the political stakeholders’ reactions and also by an impact of changes in the migration/asylum seeker/refugee flows, but this is just the cause of the issue. Anti-migrant citizen mobilizations, and particularly GD, adapts its rhetoric according to the increase or decrease in the arrival of migrants/asylum seekers and development in the social-political context of Greece. Interviewee GR28, Mobilized citizen, Chios, added:

*It is difficult, to bring the solidarity people or the political activist who has been disappointed, back to the field or to action or mobilization unless we apply exogenous pressures like a racist attack or with a possible increase in refugee flows. The increase or decrease in flows might have the opposite effect, to increase fascism. In my opinion, not just in relation to the movement, what I see in this bogged state nationwide where only an exogenous factor could affect. For example, in January, we were discussing what to do with the visit of the fascists, people were mobilized since we do not see them on a daily basis like in January 2018, when members of GD came to the island. So, the question is, will that exogenous factor last or it will be a flare which will slowly die out? Will there be a reaction and then we will become inactive again? Indeed, a fascist attack will actually generate shock waves and ignite our reflexes, but it is unsure if the reflections and reactions created by an increase in refugee/migrant flows will be directed towards one or the other side.*

## References

- Cabot, H. (2018). "From the Twilight Zone to the Limelight", in E. Doxiadis and A. Placas (eds.), *Living under Austerity*. New York: Berghahn: 280-301.
- Ellinas, A. (2013). The Rise of Golden Dawn. *South European Society and Politics*, 18 (4): 543-565.
- Fouskas, T. and Tsevrinis, V. (eds.) (2014). *Contemporary Immigration in Greece: A Sourcebook*. Athens: European Public Law Organization Publications.
- Greek Asylum Service (2018a). Statistical data from June 07, 2013 to December 31, 2018. Available at: [http://asylo.gov.gr/en/wp-content/uploads/2019/01/Greek\\_Asylum\\_Service\\_Statistical\\_Data\\_EN.pdf](http://asylo.gov.gr/en/wp-content/uploads/2019/01/Greek_Asylum_Service_Statistical_Data_EN.pdf) and [http://asylo.gov.gr/wp-content/uploads/2019/01/Dashboard\\_december\\_2018.pdf](http://asylo.gov.gr/wp-content/uploads/2019/01/Dashboard_december_2018.pdf)
- Hatzopoulos, V., Fouskas, T., Grigoriou, P. et al. (2017). *The Changing Influx of Asylum Seekers in 2014-2016: Member State Responses*. Athens: European Public Law Organization/Hellenic Ministry for Migration Policy/European Commission/European Migration Network.
- Hellenic Police (2018). Statistics on Irregular Migration. Athens: Hellenic Police. Available at: [http://www.astynomia.gr/index.php?option=ozo\\_content&perform=view&id=78538&Itemid=73&lang=](http://www.astynomia.gr/index.php?option=ozo_content&perform=view&id=78538&Itemid=73&lang=)
- Imerisia (2015). The Greeks teach solidarity to the whole world (Imerisia, October 25, 2015). Available at: <http://goo.gl/NNGJ6f> (in Greek).
- International Organization for Migration (IOM) (2017). Missing Migrants Project. Geneva: IOM, (accessed on: December 10, 2017, Available at: <https://missingmigrants.iom.int/>
- Kandylis, G. and Kavoulakos, K. (2011). Framing Urban Inequalities. *Greek Review of Social Research*, 136 C: 157-176.
- Kathimerini (2017). "Lesvos on strike in protest against migrant 'prison'", (Kathimerini, November 20, 2017). Available at: <http://goo.gl/MEHkCa>
- Knott, A. (2018). Guests on the Aegean. *Mobilities*, 13 (3): 349-366.
- Koronaïou, A. and Sakellariou, A. (2013). Reflections on 'Golden Dawn', Community Organizing and Nationalist Solidarity. *Community Development Journal*, 48 (2): 332-338.
- Lazaridis, G. and Skleparis, D. (2016). Securitization of Migration and the Far Right. *International Migration*, 54 (2): 176-192.
- Lazaridis, G. and Veikou, M. (2017). The rise of the Far Right in Greece and Opposition to 'Othering', Hate Speech, and Crime by Civil and Civic Organizations. *Journal of Civil Society*, 13 (1): 1-17.
- Ministry of Citizen Protection/National Coordination Center For Border Control, Immigration and Asylum (2018). National Situational Picture Regarding the Islands at Eastern Aegean Sea (31/12/2018), Athens: Ministry of Citizen Protection. Available at: <http://www.mindigital.gr/index.php/προσφυγικό-ζήτημα-refugee-crisis/3347-national-situational-picture-regarding-the-islands-at-eastern-aegean-sea-31-12-2018>
- National Center for Social Solidarity (NCSS)/UNISEF (2018). Situation Update: Unaccompanied Children in Greece: 31/12/2018, Athens: NCSS/UNISEF. Available at: <https://ekkadashboard.files.wordpress.com/2019/01/ekka-dashboard-31-12-2018.pdf>
- Oikonomakis, L. (2018). "Solidarity in Transition". In: D. Della Porta (ed.), *Solidarity Mobilizations in the 'Refugee Crisis'*. Basingstoke: Palgrave Macmillan, pp. 65-98.
- Ovenden, K. (2018). *The Terrorist Activity of Neonazi Organisations in Europe – The Case of Golden Dawn*. Brussels: European United Left/Nordic Green Left.
- Papataxiarchis, E. (2016a). Being 'There' - part 1. *Anthropology Today*, 32 (2): 5-9
- Papataxiarchis, E. (2016b). Being 'There' - part 2. *Anthropology Today*, 32 (2): 3-7.
- Petrou, M. and Kandylis, G. (2016). Violence and Extreme-right Activism. *Journal of Intercultural Studies*, 37 (6): 589-604.
- Psarras, D. (2014). *Neo-Nazi Party 'Golden Dawn' in Greece*. Athens/Brussels: Rosa-Luxemburg-Stiftung.
- Rozakou, K. (2012). The Biopolitics of Hospitality in Greece. *American Ethnologist*, 39 (3): 562-577.
- Rozakou, K. (2016). Socialities of Solidarity. *Social Anthropology*, 24 (2): 185-199.
- Rozakou, K. (2018a). *Out of "Love" and "Solidarity"*. Athens: Alexandria (in Greek).
- Rozakou, K. (2018b). "Solidarians in the Land of Xenios Zeus". In: D. Dalakoglou and G. Aggelopoulos (eds.), *Critical Times in Greece*. London: Routledge, pp. 188-201.
- Sakellariou, A. (2015). *Golden Dawn and its Appeal to Greek youth*. Berlin: Friedrich Ebert Stiftung.
- Serntedakis, G. (2017). 'Solidarity' for Strangers. *Etnofoor*, 29 (2): 83-98.
- Smith, H. (2015). Shocking images of drowned Syrian boy show tragic plight of refugees (The Guardian, 2015, September 2). Available at: <https://www.theguardian.com/world/2015/sep/02/shocking-image-of-drowned-syrian-boy-shows-tragic-plight-of-refugees>



United Nations High Commissioner for Refugees (UNHCR) (2018a). Mediterranean Situation: Greece, Athens: UNHCR.

United Nations High Commissioner for Refugees (UNHCR) (2018b). Sea Arrivals Dashboard. Athens: UNHCR. Available at: <https://reliefweb.int/sites/reliefweb.int/files/resources/67586.pdf>

### 6.3. Parents' mobilizations during the refugee crisis. A brief overview of the Oraiokastro and Samos cases

*Maria Siamaga<sup>1</sup>, George Siakas<sup>2</sup>*

#### **Abstract**

Since 2010, Greece has gone through a deep crisis with an important social impact. This crisis initially appeared as a fiscal one, but it quickly evolved, leading to major political implications. Mainly due to the Syrian Civil War, Greece became the first gate into the EU for millions of migrants. The Dublin III Regulation, under which migrants should apply for asylum in the first EU state they enter, has led to EU external border States to bear the brunt of migrant arrivals. As a consequence, Greece faced a chronic overcrowding. Especially, as the asylum process is running at a slow pace, Greek islands such as Lesbos, Chios and Samos, were overloaded.

As a response, hosting centers and hot spots in various areas throughout the country were created. This caused turbulence within the local communities. Especially the government's effort, which started in 2016, to incorporate the immigrants and refugees into the local societies by placing their children aged 6-15, into the public schooling system, has triggered a period of high mobility.

This project aims to investigate actions and reactions of the Parents' Associations in six primary schools in four different areas, Oreokastro, Profitis, Philippiada and Samos. We are particularly interested in exploring what brought parents of different political views, educational levels, and statuses, together. What triggered these mobilizations, and whether the perceived goal was achieved. We also want to see how homogenous the mobilizations were, how they evolved through time and what kind of local support they received.

Methodologically, we have conducted a cross-sectional survey poll, fielding a representative sample from the population of an urban area (Oraiokastro) and from an island (Samos island). The findings of this poll will be enriched by findings from the semi-structured interviews of participants or bystanders of the parents' movement mobilizations. Semi-structure interviews' sampling units will be selected by convenience and/or snowball sampling.

**Keywords:** Refugee Crisis, Social Movements, Mobilization, Collective Action, Public Opinion

#### **Introduction**

The civil war in Syria has led millions of people towards leaving their own country. For many of them Greece became the first gate into the European Union. In 2015, Greece faced an enormous increase in the numbers of border crossings; More than 850K people used the Eastern Mediterranean route -from Turkey to Greece-, predominately by sea, from the Turkish coastline to the Greek islands, or by land, through the Evros river, to the Eastern Greek mainland. This chronic overcrowding was a consequence of the Dublin III regulation which mandates that migrants should apply for asylum in the first EU state they enter.

In order to control the numbers, the Greek government created hot spots and hospitality centers, spread throughout the country. The basic hospitality centers of Moria in Lesbos and Souda and VIAL in Chios were overloaded, with many instances of violent incidents (CnnGreece, 2019a; 2019b). In order to decongest the islands and exacerbate the tension, the government ordered the urgent move of a number of refugees and

<sup>1</sup> PhD Candidate at the University of Macedonia, Greece. Email: Maria.siamaga@uom.edu.gr

<sup>2</sup> Research Director at the Public Opinion Research Unit, University of Macedonia Research Institute, Greece.

immigrants towards the mainland. In an effort to make the incorporation of immigrants and refugees easier and smoother into the Greek society, the government decided to place their children, aged 6-15 into the primary and secondary public schooling system. This decision triggered a period of high mobility, throughout Greece. Parents reacted through their associations' boards primarily in the public elementary schools.

This paper tackles with the breakout of the parents' movements in two main areas with adjacent hospitality centers. The main research question investigates the way that the parents' mobilization broke out and the characteristics of the movements, such as their demands, and the dynamic, referring to the degree of support of local communities etc. In the following sections, we present the methodology and research design, as well as the main findings of the cases under investigation.

### **Methodology**

In response to the main research question, our research project aims at studying the actions and reactions of the Parents' Associations in areas that this movement gained publicity and durability. On an attempt to capture attitudes and stances towards the issue, we followed a mixed mode research design. A cross sectional survey with CATI mode of data collection was fielded on a random sample of 649 participants from Oraikastro and Samos. The cross-sectional poll included respondents that either had or hadn't children in the elementary schools. Further, in order to triangulate, we have conducted 6 semi-structured, in depth interviews from parents from the 1<sup>st</sup> Elementary School of Oraikastro. Samos and Oraikastro have distinct characteristics. The first is an island, located in the main Aegean Sea, and the later a landlocked rural area in the northern part of Greece.

We analyze these movements through the prism of the Resource Mobilization Theory (RMT). The RMT could explain the birth of the specific movements, as the notions of demand and supply seem to perfectly fit in our case (Leeson & Russ, 2017). It also rejects the element of spontaneity and supports that the decision of participating or not in any movement is taken after a rational process has taken place (Klandermans, 1984, Jenkins, 1983). In addition, the RMT claims that grievances can be manipulated, an argument that is supplemented by the Framing Theory (FT). The Framing Theory (FT) and the construction of collective identity could provide some explanatory dynamic in order to be able to understand the whole mobilization process. In addition, the FT could assist in the overall interpretation of the general public's opinion on important for the society issues (Scheufele, 1999, Owen, 2017).

### **The cases of Oraikastro and Samos**

Oraikastro is an urban area, located 11 km from the center of Thessaloniki, with a population, of approximately 38.000 people. The government's decision to open up six hotspots and hospitality centers, with a capacity of approximately 6800 people, within a radius of 12 km caused anxiety within the local community. For weeks on, the main discussion topic in Oraikastro was the relocation of the immigrants and refugees close and to the area. People believed that the government's argument of trying not the create immigrant and refugee

“ghettos” did not apply in their case, as they felt they were being surrounded by hot spots and hospitality centers, hence they felt cut off.<sup>3</sup>

There was a feeling of disappointment and anger as they felt that the western part of Thessaloniki, being always the lower middle-class area was chosen once more to bear the biggest numbers of the immigrants and refugees for resettlement. The main issue was the lack of communication between the state and the local authorities and consequently the local community.<sup>4</sup> Before the government announced the official list of schools that were going to function as Refugee and Immigrant Education Centers (DYEP), the council of the Parents’ Association of the 5<sup>th</sup> Elementary School of Oraiokastros (ex Melisohori, Skaras) publicized a letter of protest against the entry of immigrant and refugee children into the public schooling system, which was followed by the 1<sup>st</sup> Elementary School of Palaiokastros.

This caused the immediate reaction of the justice department which ordered a prosecutor’s urgent investigation on the grounds of “racist violence”. Once the government announced the official list, the Oraiokastros 1<sup>st</sup> Elementary School’s Parents’ Association expressed their concerns through a letter addressed to all the public officials involved, primarily focusing on health and safety issues. The parents felt that they were given no assurance on the health (both physical and mental) condition of the children who were going to attend classes. In addition, the then mayor himself, urged people to mobilize, protest and react to the immigrants’ settlement there. This marked the beginning of the parents’ mobilizations for the case of Oraiokastros.

In Samos, it all started in November of 2018, when the Minister of Immigration Policy Vitsas, acknowledged that the situation on the island is “marginal and difficult.”<sup>5</sup> The hospitality center which was created and designed to accommodate 700 people had, at the time, more than 4,000 people inside, and an additional 2000 people outside, in an informal hot spot set up by mainly Afghan and African nationals. Due to the long delays in the asylum process, people have been stranded on the island for many months. As a result of the long delays, people were irritated, and the outcome was the constant clashes among the refugees and the immigrants as well as the former with locals inside and outside the hospitality center. In an assembly which took place on March 4, 2019, the parents of the Elementary school of Vathi decided to have their kids abstain from classes for four days (from Tuesday March 5 to Friday March 8, 2019), while, at the same time, they organized a protest outside the building of the District’s Primary Education offices, inviting all the Parents’ Associations of the district of Samos.

### **Exploring the causes**

We’ll test three hypotheses, each of which corresponds to the main research question. These hypotheses are referred to (a) the environment in which the protest was prepared and broke out, (b) the context of the reaction

---

<sup>3</sup> Interviews, personal records.

<sup>4</sup> Interviews, personal records.

<sup>5</sup> For further information see: Minister’s press conference, November 15, 2018.

in respect to the specific demands of parents' mobilization and (c) the overall assessment of the perceived success of the protest.

### H1. The favorable environment of the parents' mobilization

In the local level, both the parents and the general public agree that the number of immigrants and refugees is very big in Greece. This is in accordance to the general (nationwide) public opinion eminent in all surveys that deal with immigration (Marantzidis & Siakas, 2019). In addition, with lower, yet still quite high, percentages, both the general public (over six out of ten people) as well as the parents (seven out of ten people) agree that immigration has increased criminality. The percentages that regard immigration and unemployment are the lowest of the negative answers, with four out of ten participants and parents still believe that the immigration is capable of increasing unemployment.

**Table 1. Oraiokastros & Samos public opinion attitudes towards refugees and immigrants**

Immigrants' presence	%
Is too extensive	91
Increases criminality	62,5
Increases unemployment	41
Has positive effect on the economy	30
Helps cultural enrichment	38,5
Helps the demographic problems	24,5

Regarding the potential positive effect on the economy, only three out of ten survey participants believe that immigration could become an asset. This is even lower among parents. More people believe that immigration can offer cultural enrichment. The lowest percentages of all appeared when asked about whether immigration can help the demographic problem of Greece. The fact that both parents and the general public score higher on the negative questions and lower on the positive ones happens primarily due to the general belief that the majority of the immigrants and refugees do not want to get incorporated into the Greek society, hence they believe that the immigrants and refugees will be the misfits. This negativity regarding the immigrants and refugees can offer a favorable atmosphere for the creation of movements against them.

In addition, and although initially it looked like the Golden Dawn was hiding behind the parents' mobilizations, we found out in the process, that although the GD tried to be a part of the mobilizations by sending members to the General Assemblies, held by the boards of the parents' associations, they were not accepted to take part and be present in the auditoriums. According to personal testimonies, the parents were not willing for their mobilizations to have "colors" and be connected to any political party.

As already mentioned, the context of the environment has a significant role in the mobilization birth and evolution. The interviewed people, for example consider that "The society, the people of Oraiokastros were with us" (Thodoris M., Male, 46). Moreover, the fact that the case of Oraiokastros gained publicity by being a prominent issue, as it was projected by prime-time TV shows in major nation-wide media and gaining for the

most part negative press, brought the local society closer together. As an illustration, Pelagia K., (Female, 37) said that “... the society supported us. I am telling you, everybody was stigmatized, not just the parents of the 1<sup>st</sup> E.S. Everybody was labeled as fascists.... Everybody was trying to prove that they were not elephants...”. Also, a member of the parents’ mobilization group insisted on the public support of this collective action. “The society, the citizens did not oppose to what we were doing.... They all said well done!”, said Eleni V. (F, 48).

**H2. The blurring mobilization discourse.**

Previously, we’ve established that the overall setting was hostile to the immigrants’ presence. This was affirmed by the findings of the cross-sectional targeted poll and also explained by the semi-structured interviews. But, apparently, the environment alone could provide a fertile ground, but the initiative should be based on a specific agenda. This agenda was also apparent in the cases under exploration.

Participants were asked to provide us the reasons why they thought parents were so strongly opposed to the government’s decision to incorporate immigrant and refugee children into the public schooling system. We have noticed an oxymoron in their responses. The percentage of the parents who believe that they mobilized just because the kids were not wanted and that everything was just an excuse is the highest one and reaches almost 60%. So, on one hand we could illustrate some concrete arguments about the denial of the immigrants’ children, but on the other, there is a significant majority who considers that all the arguments present a thin centered argumentation that covers other principal causes.

Exploring the reporting arguments, we could notice that the “health factor” is considered to be the primary reason for mobilization. More than 50% of the parents in both Oraiokastros and Samos supported that. This is also supported by the personal interviews. Of course, one of the major concerns in this argumentation is that parents were not given the appropriate assurance by the Greek State and officials that the immigrant and refugee children were in good mental and physical condition to attend school. With regard to another argument, the capacity factor, the public opinion doesn’t consider it as an issue. Only in Oraiokastros, it is considered a secondary factor, as the 1<sup>st</sup> Elementary School is the oldest school in the area and its facilities do not respond to the increasing numbers of the population, with portable classrooms being placed in the school’s courtyard.

**Table 2. Oraiokastros & Samos public opinion attitudes towards arguments on children’s’ presence**

Arguments related to parents’ mobilization	% among parents	Population %
Health issues was the most important matter for mobilization	56	47,5
Simply they didn't want them and provided excuses	57,5	52,5
Serious capacity issue	44	40,5
Children’s presence creates learning difficulties	42	40
Helps Greek children to get along with new cultures	60,5	68
Helps children’s integration into Greek society	73	78,5

Although there were major objections to the government's decision of incorporating the refugees and immigrants into the Greek society and the local communities by placing their children into school, there is an apparent general consensus that this, indeed, does assist with the integration of the immigrants and refugees and the easier transition from their home countries to Greece. Further, both parents and the general public agree that the entry of the immigrant and refugee children into the schools and the interaction with the Greek children could help the latter get acquainted with different cultures, hence broaden their horizons, get used to living in a multi-cultural environment and deal with globalization in general.

On the opposite direction, the argument of the slower learning pace and the creation of learning difficulties to the Greek children doesn't seem to be supported. Nearly one out of four -both parents and the general population- believe that placing immigrant and refugee children into the classrooms together with Greek native speakers could essentially create learning difficulties for the Greek children, primarily due to the lack of knowledge of the Greek language. So, although the parents mobilized, they mostly agree that only good things could come out of the immigrant and refugee children placement into the classrooms, which supports even more the argument that the parents' objections were not directed towards the children because they were not Greek but mainly towards the State and what they thought to be insufficient assurance of the health conditions of the immigrant and refugee children.

### **H3. The assessment of movements' success.**

The cross-sectional survey reveals an overall conservative assessment on the mobilization movement; 14.5% of the general public and the 21.5% of the parents consider the mobilizations as being successful, although we have noticed that participants' definitions of success varied. For example, some have assessed the success as the simple result of "gaining time", in the sense that the Immigrant and Refugee Education Centers did not start at their schools. At the same time, some more sophisticated attributes could be spotted, such as the opportunity to wider the audience and offer a larger impact on the overall parents' objections to be widely spread. The most common answer among the interviewees was that they considered the mobilizations successful due to the fact that the DYEP was postponed throughout the Oraiokastros area. Eleni V, F, 48 mentioned that "So far they (the mobilizations) have been successful. We do not have DYEP in our schools at all".

Some other protestors claimed that the main goal of the mobilizations was for the parents to be heard, their arguments to be known and in that sense, they consider the mobilizations as being successful as well. "One thing they (the mobilizations) managed to succeed was the awakening of the society. I saw people "waking up". I was one of them .... The second thing was, I think, that we managed to be heard" said Dimitris K., M, 51. Further, there are participants who define success as an act of further precaution on the part of the State and at the same time an act on behalf of the central government to show local interest ("The entry criteria became stricter, the government started looking deeper..... For me the 3-year delay was a victory" (Vicky K., F, 43).

## **Conclusions**

Our attempt to study parents' actions and reactions regarding the entrance of immigrant and refugee children into the public schooling system could become an important asset in the effort of the deeper investigation and understanding of social issues in the current situation of the extensive migration of populations in a small border country, such as Greece. The RMT, complemented by the FT, could well explain the birth of the specific movements and the notions of demand and supply. The RMT rejects the element of spontaneity and supports that the decision of participating or not in any movement is taken after a rational process has taken place, something that is clear in our case through the personal interviews held. The RMT also claims that grievances can be manipulated, something that is very well supplemented by the Framing Theory.

The Framing Theory and the construction of collective identity could help us understand our cases mobilization process. Furthermore, the Framing Theory can help us interpret the role of the Media and how they can shape the general public's opinion on important for the society issues. In order for people to mobilize there must be a favorable environment which will provide the grounds for the creation and growth of a movement. This is apparent in our case, as there is a general negativity regarding the immigrants and refugees primarily, we believe, due to their extensive numbers. In addition, the parents' overall opinion towards the immigrants and refugees seems to be even more negative than the general population. These is, of course, mainly due to the fact that the parents are the ones "mostly affected" by the entry of immigrant and refugee children into the Greek public schooling system, which, in return, affected their feelings towards immigrants and refugees in general.

The overall setting in Oraioakastro and Samos, in alignment with the overall mood nationwide, was hostile for the immigrants' presence. But, apparently, although the environment alone could provide a fertile ground, the reported upheaval is based on a specific agenda. This agenda was also apparent in the cases under exploration. The primary cause for mobilization is the fact that parents thought were not given enough assurance by the State on the health condition of the children who were going to attend classes in the program; yet they all recognize the positive impact of the interaction among the immigrant and refugee and the Greek children, as well as they admit that such an effort would make the transition not only of the children but also of their parents into the local societies easier.

The mobilizations do not seem to be perceived as being successful by the local communities. This is not the case for the parents, as almost one out of four parents think the movements were successful one way or another. The support (McCarthy & Zald, 1977) given to the mobilizations by the local communities, seems to differ as well, as almost four out of ten parents thought that the local communities were being supportive. On the other hand, three out of ten participants in the survey were against the mobilizations and therefore were not supportive of them. It might be too early to say whether mobilizations such as these ones will take place in the future in Greece. We will leave this up to time to tell.



## References

- Asara, V. (2016). The Indignados as a Socio-Environmental Movement: Framing the Crisis and Democracy. *Environmental Policy and Governance*, 26(6): 527–542.
- Benford, R. D. (1997). An Insider's Critique of the Social Movement Framing Perspective. *Sociological Inquiry*, 67(4): 409–430.
- Benford, R. D., & Snow, D. A. (2000). Framing Processes and Social Movements: An overview and Assessment. *Annual Review of Sociology*, 26: 611.
- Buechler, S. M. (1993). Beyond Resource Mobilization? Emerging Trends in Social Movement Theory. *The Sociological Quarterly*, 34(2): 217–235.
- Cohen, J. L. (1983). Rethinking Social Movements. *Berkeley Journal of Sociology*, 28: 97–113.
- CnnGreece (2019a). Chios Refugees. Available at: <https://www.cnn.gr/eidhseis/tag/xios-prosfyges> (in Greek).
- CnnGreece (2019b). Hot spot in Moria. Available at: <https://www.cnn.gr/eidhseis/tag/hot-spot-morias> (in Greek).
- Della Porta, D. & Diani, M. (2009). *Social Movements: An Introduction* (2nd Edition). Wiley-Blackwell Publishing.
- Della Porta, D., Kriesi, H., & Rucht, D. (Eds.). (1999). *Social movements in a globalizing world*. London: Palgrave Macmillan.
- Desrosiers, M.-E. (2015). Tackling Puzzles of Identity-Based Conflict: The Promise of Framing Theory. *Civil Wars*, 17(2): 120–140.
- Eltantawy, N., & Wiest, J. B. (2011). The Arab Spring. Social Media in the Egyptian Revolution: Reconsidering Resource Mobilization Theory. *International Journal Of Communication*, 5(18): 1207–1224.
- Foweraker, J. (1995). *Theorizing Social Movements* (1st ed.). London, Colorado: Pluto Press.
- Hunt, S. A., Benford, R. D., & Snow, D. A. (1994). Identity Fields: Framing processes and the Social Construction of Movement Identities. In *New Social Movements: From Ideology to Identity*. Philadelphia: Temple University Press, pp. 185–208.
- Jenkins, J. C. (1983). Resource Mobilization Theory and the Study of Social Movements. *Annual Review of Sociology*, 9(1): 527–553.
- Johnston, H., & Klandermans, B. (1995). The Cultural Analysis of Social Movements. In *Social Movements, Protest, and Contention: Vol. 4. Social Movements and Culture*. University of Minnesota Press, pp. 3–24.
- Johnston, H., & Noakes, J. A. (Eds.). (2005). *Frames of protest: Social movements and the framing perspective*. Lanham: Rowman & Littlefield Publishers, Inc.
- Ketelaars, P., Walgrave, S., & Wouters, R. (2017). Protesters on message? Explaining demonstrators' differential degrees of frame alignment. *Social Movement Studies*, 16(3): 340–354.
- Klandermans, B. (1984). Mobilization and Participation: Social-Psychological Expansions of Resource Mobilization Theory. *American Sociological Review*, 49(5): 583–600.
- Leeson, P. T. & Russ, J. W. (2017). Witch Trials. *The Economic Journal*, 128(613): 2066–2105.
- Marantzidis, N. & Siakas, G. (2019). *In the name of dignity*. Athens: Papadopoulos. (in Greek).
- McAdam, D., McCarthy, J. D., & Zald, M. N. (Eds.). (1996). *Comparative Perspectives on Social Movements: Political Opportunities, Mobilizing Structures, and Cultural Framings*. Cambridge: Cambridge University Press.
- McAdam, D., McCarthy, J. D., & Zald, M. N. (1988). Social Movements. In NJ Smelser (Ed.), *Handbook of sociology*. Thousand Oaks, CA: Sage Publications, Inc., pp. 695–737.
- McCarthy, J. D., & Zald, M. N. (1977). Resource Mobilization and Social Movements: A Partial Theory. *American Journal of Sociology*, 82(6): 1212–1241.
- Melucci, A. (1985). The Symbolic Challenge of Contemporary Movements. *Social Research*, 52(4): 789–816.
- Neveu, E. (2010). *Κοινωνιολογία των κοινωνικών κινημάτων και ιστορίες κινημάτων από το Μεσαίωνα μέχρι σήμερα* (M. Λογοθέτη, Trans.). Athens: Σαββάλας. (in Greek)
- Owen, S. (2017). Monitoring social media and protest movements: Ensuring political order through surveillance and surveillance discourse. *Social Identities*: 1–13.
- Scheufele, D. (1999). Framing as a theory of media effects. *Journal of Communication*, 49(1): 103–122.
- Snow, D. A., Rochford, E. B., Worden, S. K., & Benford, R. D. (1986). Frame Alignment Processes, Micromobilization, and Movement Participation. *American Sociological Review*, 51(4): 464–481.
- Tarrow, S. (1998). *Power in Movement: Social Movements and Contentious Politics* (2nd ed.). Cambridge: Cambridge University Press.
- Tilly, C. (2004). *Social movements, 1768-2004*. Boulder, London: Paradigm Publishers.

## 6.4. Global constitutionalism theory towards a better judgment of the asylum and immigration policies

*Danai – Georgia Koutsopoulou<sup>1</sup>*

### Abstract

This proposal originates from the connotations of assorted prevailing hurdles towards an effective and coherent Immigration and Asylum Law system within the European Union given that the EU has constantly stressed its commitment to offering international protection to people fleeing wars and persecutions in accordance with international refugee law. It describes the constitutional nature of human rights protection and their prevalence in international law as to revisit it within the precise field of Immigration and Asylum Law. On the one hand, bearing in mind the need for global commitment therein, for determinative purposes, a framing of the multi-level regulatory framework on the issue employing several classic and contemporary conceptions in terms of the policy, and the most relevant case-law of the Court of Justice is crucial. Therefore, the project aims to underline the global dimension of the Union's engagement and its historical opportunity to emerge as a sustainable consistent body and a dominant actor capable of confronting the current challenges for the sake of its external competences' compliance to the declared values of the Treaties and the *ius cogens*. On the other hand, the research embracing aspirations towards a further harmonious assortment of rules on the subject, explains why the latter shall be considered as bringing a brand-new era of constitutionalism in the EU. It follows that the endeavor conduces not only to wield the compelling contemporary calls but also to formulate a sustainable future promptly in the core of the historical lessons of division and conflict between the Member States. In that respect, it is reiterated that there is a need to incorporate and reflect on the human rights users' voices for a socially coherent and viable prospect of solidarity and mutual respect horizontally and vertically.

**Keywords:** global constitutionalism, Immigration and Asylum policy, human rights, Treaty values.

### Introduction

Notwithstanding the rejection of formal Constitutionalism, the European Union (EU), constitutionalism (the small c) (Shaw, 2017), manifests a factual hierarchy of norms. As repeatedly declared by the Court of Justice of the European Union (ECJ)<sup>2</sup> (Rosas & Armati, 2010) during the Heroic Period (Weiler, 1991), it is not only the constitutional charter<sup>3</sup> but also the reality and the very essence of a provision that manifest the specific nature of the issue at hand. The fundamental claim of the current study mounts from the absorption of sovereign competences previously owned by the Member States (MS) with regards to checks on borders and security precautions and the implications for the nexus of structural safeguards, namely human rights and institutional balance. Evidently, the Area of Freedom Security and Justice (AFSJ) is intrinsically multidimensional, as it is a *nomen iuris* attributed to a general policy containing autonomous policies and sub-policies, both internal and external.

Furthermore, the experience of comparative constitutionalism confirms that in such legal systems, there is always a question of fairness, justice, and effectiveness. This symbolizes a political community owned by the people, within which fundamental norms such as human rights play a principal role. Both in the European and

<sup>1</sup> Lawyer, Doctoral Candidate at the University of Hamburg. Email: danaekoutso@gmail.com

<sup>2</sup> Case 294/83 *Les Verts* [1986] ECLI:EU:C:1986:166, para. 23.

<sup>3</sup> Case 294/83 *Les Verts* [1986] ECLI:EU:C:1986:166, para. 23.

the global normative order, the endeavours of modern constitutional law, challenge the power of supranational political institutions by demoting the formal structure and promote cohesion. Global constitutionalism particularly has created a theoretical reference frame with a view to exploring a range of practices, principles, and theories addressing constitutionalization at the supranational level. The European legal order is a clear example where this type of interaction between norms and norm-making occur and mutate. And significantly, the AFSJ creates a subfield of this mutation. The impact of the policies on the individual (Thym, 2016) and the State as such, advance them to the core of the legal order.

Consequently, the purpose of this paper is to introduce a twofold enigma. If the Area constitutes a subfield of constitutional law, it is also important to (re)read it accordingly. If Asylum and Immigration law policies hold a higher status, their implementation inevitably becomes a priority.

Below, I shall make a brief presentation of the challenge in definitive, interpretative, and restructuring terms. This necessitates a first justification of the correlation of Constitutional Law, and especially of the European Constitutionalism legacy and the Global Constitutionalism theory through a presentation of the current disposition of policy frame and of the respective scholarship.

### **The Material Scope of this Research**

In constitutional theory, border checks and status of the foreign person entering the territory of the State traditionally constitute a matter of the core of the sovereignty (Monar, 2009), its capacity to perform public power (Law & Versteeg, 2011). Beyond the administrative aptitude, this performance inserts security concerns and fundamental rights (Monar, 2009) and questions the coherence and effectiveness of a multilevel consignment font. Nevertheless, inasmuch normative coherence and legal security should be respected and promoted, the telos of the international legal system rises to an - often structurally vaguer - value-based cognizance. Anywise, reference multiplicity, and the cardinal textual position justify the significance of these values so that they constitute a separate research field.

Firstly, as per the Treaty of the European Union (TEU), Article 3.2 TEU establishes a guiding objective towards an AFSJ without internal frontiers, in which the free movement of persons is ensured in conjunction with appropriate measures with respect to external border controls, asylum, immigration, and the prevention and combating of crime. More precisely, the Union pursues this objective by appropriate means commensurate with the competences, as provided in Title V, Chapters I and II. This entails a set of general principles ensuring the internal (solidarity) and external (towards third-country nationals and stateless people) fairness of the common policy (Article 67.2 TFEU), such as the respect of fundamental rights and the varying legal systems and traditions of the MSs (Article 67.1 TFEU). However, these provisions do not affect MSs' internal policies concerning the preservation of law, internal order, and security (Article 72 TFEU). The legal basis for EU asylum law is contained in Chapter 2 of Title V of the Treaty on the Functioning of the European Union (TFEU). Article 77. 1 a and b TFEU declare the absence of internal border controls on persons irrespective of nationality. Conversely, in external borders, a gradually (or allegedly) integrated management system for

external borders is promoted (Article 77.1.c TFEU). In this fragmented area of free movement, the conditions under which third-country nationals and stateless persons (Article 67.2 TFEU) enjoy the freedom of movement is regulated jointly by the European Parliament (EP) and the Council through the Ordinary Legislative Procedure (OLP). Article 78.1 TFEU indicates venue shopping (Kaunert & Leonard, 2012) and incorporation<sup>4</sup> of EU law and constitutes the first example of multi-inspired policing. The inscription of the Geneva Convention and the New York Protocol relating to the status of refugees has further indoctrinated<sup>5</sup> the Union law. The recitals to both the Qualifications Directive<sup>6</sup> (QD) and its recast<sup>7</sup> (QD recast) explicitly invoke the Convention's significance to the enhancement of an interpretation of that relevant legislation closer to general scheme and purpose of Refugee Convention and the other relevant treaties<sup>8</sup>. This is, namely, suggested by the requirement for uniform status in asylum, subsidiary, and temporary protection pursuant to common procedures (Article 78.2 TFEU). Moreover, Article 80 TFEU requires solidarity and fairness in the execution of the competencies, including operational and financial aspects. With respect to the juridification of the mentioned policies (initiated in the Treaty of Amsterdam), Section 5 of Part Six (Institutional and financial provisions) on the jurisdiction of the CJEU comes into play. Article 267 affords jurisdiction on two types of problems; (a) regarding the interpretation of the Treaties; and (b) regarding the cogency and interpretation of acts of the institutions, bodies, offices, or agencies of the Union. The competence from the national judge's part might be either a right or an obligation depending on whether the court or court or tribunal rules on final resort or not. Article 6.1 TEU stands in the middle between the TEU and the Charter of Fundamental Rights (CFR). It affords equivalent legal value to the latter, notwithstanding the principle of enumerated powers (Article 6.1.b TFEU). The incorporation of the Charter in the primary law validated the Court's repeatable tradition in recognizing multiple, pluralistic layers of inspiration<sup>9</sup>. Article 6.3 TEU provides that "*fundamental rights, as guaranteed by the [ECHR] and as they result from the constitutional traditions common to the Member States, shall constitute general principles of the Union's law*". Read in conjunction with Article 52(3) CFR, the ECHR and the case-law of the European Court of Human Rights (ECtHR) constitute an important source of such inspiration, not precluding, nevertheless, the grant of broader protection by EU law<sup>10</sup>.

Secondly, in the case of the Geneva Convention, it is contested whether there is a case of incorporation. Regarding the jurisprudential balance between the ECJ and the ECtHR, the hesitation of an admittance similar to the previous case is justified. However, with regards to an integrated reading of human rights protection

---

<sup>4</sup> Conversely, in Case C-481/13 *Qurbani v Germany* [2014] ECLI:EU:C:2014:2101 para.25.

<sup>5</sup> Case C-481/13 *Qurbani v Germany* [2014] ECLI:EU:C:2014:2101 para.25.

<sup>6</sup> Directive 2004/83/EC on minimum standards for the qualification and status of third-country nationals or stateless persons as refugees or as persons who otherwise need international protection and the content of the protection granted.

<sup>7</sup> Directive 2011/95/EU on standards for the qualification of third-country nationals or stateless persons as beneficiaries of international protection, for a uniform status for refugees or for persons eligible for subsidiary protection, and for the content of the protection granted (recast).

<sup>8</sup> Case C-31/09 *Bolbol* [2010] ECLI:EU:C:2010:351 paras.36-38.

<sup>9</sup> Joined Cases C-411/10 and C-493/10 *NS*, [2011] ECLI:EU:C:2011:865 para.119.

<sup>10</sup> Opinion 2/13, Accession of the European Union to the European Convention for the Protection of Human Rights and Fundamental Freedoms, ECLI:EU:C:2014:2454.

(Desmet, 2018), this is practically unrealistic and in terms of social legitimacy insufficient (Weiler, 1991). Moreover, the Protocol No 24 on Asylum for Nationals of the MSs, forms an equal part of primary law. It provides an *erga omnes* declaration of MSs as safe countries of origin regarding the policy. Consequently, EU citizens are excluded from the QD recast, and practically thrusts them to invoke the Refugee Convention in another MS. In this unusual case, any application shall be examined as per its admissibility especially with regards to the compliance of the MS of persecution with the ECHR, with regards to applied or soon to be applied suspension proceedings under Article 7.1 and 7.2 TEU, and as to the adequate information of the Council on the application upon acceptance by the MS referred.

The primary law does not exhaust the constitutionalistic relevance of the issue. Despite the framing of secondary law as such, its constitutional significance concerning the Common European Asylum System (CEAS), exemplifies institutional ideas relevant to the general principles of EU law, the constitutional traditions of the MSs and in the case of the Global Constitutionalism from the constitutions of most countries (McCrudden, 2000).

Consequently, the material scope of this research is to explore the constitutional *genus* within the “transnational judicial conversations” and the “common law of human rights”, because “although most post-Second World War constitutions have specifically laid down elements which set them apart, most also have a common core of human rights provisions that are strikingly similar, and this is not merely coincidental” (McCrudden, 2000: 499).

In a living matrix of democracy (Weiler, 1991), the introduction of constitutional principles contributes to the stability of expectations, legal certainty, and equal treatment of the relevant actors. The idea is not to create a global centralized government but to constitutionalize its polyarchic and multilevel governance. Beyond the terminological divisions among constitutions of (un)written content, constitutionalism, as normative “catchword” for the continuing process of the emergence, creation, and identification of constitution-like elements such as power limit, the guarantee of rights, legitimate authority, and the constitutionalization as the process thereof, they all eventually incised in deferred *momenta*.

In the proposed compensatory (Peters, 2006) regime we seek to address the de-constitutionalization on the domestic level due to globalization and the radicalization. For this reason, the existing constitution is not dealt with as a sacred text as such. There is a need to investigate which of the diverge principles and conditions can form a bottom up solution. Furthermore, it shall be reiterated that the vision of the abolition of internal frontiers partially did not collapse because of the refugee crisis and any concerns about terrorist attacks but because of lack of uniformity and full respect for the Schengen *acquis*.

Global constitutionalism appears to be both a hypothesis and a response to the saturation of the system.

## **II. European Constitutionalism: The EU as an AFSJ – competences, principles and challenges**

An evaluative description of the European Constitutionalism within the polity itself, its normative content (legal rules), and its social content (legitimacy), in the specific field at stake shows that European Constitutionalism has changed in terms of engagement with constitutional ideals throughout history. Economic, political, geopolitical changes have contributed to the enhancement of the narrative. However, the most significant steps thereto have been made by the Court regarding its own jurisdiction and its perception of the territorial scope of Union law. One of the most fundamental hypotheses of the present study is grounded on the existence of a constitutional charter based on the rule of law<sup>11</sup>, where the Treaty law governs in guiding and interpretative terms the legislator. In this order of considerable disparities and political geometry, the AFSJ describes a territorial circle or regime of integration (Monar, 2009), where the core of the State and the status of the individual reconcile (Thym, 2016). The attempt is challenging in terms of legitimacy and institutional balance of competence, human rights protection, right to safety, external competence.

The second position of equal value refers to institutional and normative changes at the global level in opened forms the ideological and teleological basis that may be referred to as its constitutionalization. The EU allegedly stands as a mediator and a paradigm of inclusion, by paying a high price of dissatisfaction of its citizens, of the rise of populism and of financial strains.

Throughout consistent response based on a teleological approach to the interpretation of legal texts in view of its implicit and sometimes explicit understanding of the integration project (doctrinal constructivism) (von Bogdany, 2009), the Court constructed a hierarchy of norms by instigating direct effect, direct applicability, and primacy. On the one hand, this set the leitmotiv of constitutionalization emanating by the supranational legal order. On the other hand, it stressed a uniform application of rights and obligation centred to the individual (new constitutionalism versus pluralization). In the Court's teleological justification for the invocability of obligations and rights by individuals before national and communitarian courts, a slight suspicion against the MSs executives' potential effectiveness and accountability was implied. It meant that any other interpretation would render the protection of human rights ineffective by disparate predatory policies by the powerful states. Along with this premise, the Court assured the uniformity of the created standards among States and created an unbreakable judicial bond among the national courts among themselves and the ECJ.

Now, especially after the perceived migration crisis, mass population movements, along with economic shocks and domestic crises, challenge the sustainability of frontier free travel and mobility. For the human rights applicability, the proposed restrictions challenge absolute<sup>12</sup> and relative recognitions and the limits of sovereign capacity and legitimacy of the action.

---

<sup>11</sup> Case 294/83 *Les Verts* [1986] ECLI:EU:C:1986:166, para.4.

<sup>12</sup> i.e. prohibition of torture and cruel and inhuman or degrading treatment or punishment.

### A. The vertical tensions: allocation of competencies, territoriality and uniformity

AFSJ policies have steadily towards enhanced EU competence and a greater role for the community method - use of the established process of decision-making involving a Commission legislative initiative being accepted by the Council, and usually the EP. Co-decision, Qualified Majority Voting, accelerated integration, and full jurisdiction of the Court against the backdrop of the previously vetoed measures are now a reality. Prior to the Treaty of Amsterdam, the informal intergovernmental system, by means of Conventions or soft law acts being resolutions or recommendations, appeared obscure and called for more formally amplified intergovernmental arrangements, an official legal framework for the adoption of measures by the Council, which Maastricht awarded.

The lack of defined status and the exclusion of the EP, whereas the MSs were consulted in the Commission's initiative, has certainly borne a still evident risk. The official expression of the MSs' self-interest and the lack of institutional engagement formed a destiny of division. Furthermore, it weakened the legitimacy and support for the policy. In a frame where UK, Ireland, Denmark even after the incorporation of the Schengen acquis in the Treaty of Amsterdam were initially granted an opt-out, then UK and Ireland would choose whether they desired to participate in negotiations, the acquis is not acquis for all. Arrangements such as those granting opt-in at any time, while discussions could proceed either way and measures could be approved, set a constitutional question regarding integration. The trinity did not wish to participate into the core of the Schengen, so according to the Court neither to building upon EU acts.

Notwithstanding, exceptions<sup>13</sup> and suspension<sup>14</sup>, Schengen borders code manages the control and surveillance of external borders introducing an institutional tension with national divergencies. This, for instance, was the case of the Council's attempt to exclude the EP from co-legislating<sup>15</sup> due to the alleged applicability of Article 70 TFEU, the tension emerged therefrom, ending to enhancing Commission's<sup>16</sup> competences. The vision of the abolition of internal frontiers remains unaltered, at least in principle, which means that the reasons for the collapse are to be found in the application and the sincere engagement of the MSs and the Union in practice.

This might for instance, entail an assessment of the necessity for transformation of the Schengen Information Systems (SIS), a system of alerts for refusal of entry to Third Country Nationals (TCN), the Frontex, the budget administration and the European Border Surveillance System (EBSS). The evolution of the visa policy is again indicative of the contextual preparedness of the MSs for concessional integration. From the partially

---

<sup>13</sup> Case C-575/12 *Air Baltic* [2014] ECLI:EU:C:2014:2155 paras.35, 45, 50, 66-68.

<sup>14</sup> Regulation (EC) 562/2006 establishing a Community Code on the rules governing the movement of persons across borders (Schengen Borders Code), OJ L 105, 1.

<sup>15</sup> i.e. Proposal for a Regulation amending Regulation (EC) No 562/2006 in order to provide for common rules on the temporary reintroduction of border control at internal borders in exceptional circumstances, COM.

<sup>16</sup> Regulation (EU) 1051/2013 *amending Regulation (EC) No 562/2006* in order to provide for common rules on the temporary reintroduction of border control at internal borders in exceptional circumstances, OJ L 295, 1; Council Regulation (EU) No 1053/2013 establishing an evaluation and monitoring mechanism to verify the application of the Schengen acquis, OJ L 295, 27-37.

harmonized original visa list of 1995, till the incorporation of the Schengen acquis, the criteria have always been political *quid pro quo*, enshrining the *ne plus ultra* of who “deserves” visa facilitation<sup>17</sup>.

As for immigration, Articles 67.2 and 79.1 TFEU request the framing of a policy, based on solidarity and fairness towards TCN, efficient management of migration flows, and the prevention of and enhanced measures to combat illegal immigration and trafficking. It is questionable whether the principles of solidarity, fairness and efficiency are achieved or even targeted. Within readmission agreements with third countries of origin or provenance and the legislation on the *prevention* – carrier sanctions<sup>18</sup>, criminalization of the facilitation of irregular entry<sup>19</sup>, trafficking<sup>20</sup>, and the posting to non-EU countries<sup>21</sup>; on the *treatment* – sanctioning employers of irregular migrants and permitting the stay of trafficking victims<sup>22</sup>; a “policy plan on economic integration”, through the Single Permit<sup>23</sup> and Blue Card Directives<sup>24</sup> and the Directives on intra-corporate transferees and seasonal workers<sup>25, 26</sup>, or on family reunification<sup>27</sup> - , and the *expulsion* of irregular migrants – detention, entry bans, and procedural rights<sup>28</sup> stemming therefrom, the EU does not appear to engage to an integrational scheme but rather to shift the responsibility of the inclusion to the individuals. The above documents expose the divergence between the declared values and the actual policies and underline the national factor, if not the tendency to satisfy certain MSs, jeopardizing the federal balance (von Bogdany, 2009).

Most importantly, asylum law offers evidence of multidimensional legal sources for the determination of the status of refugees, either as per the 1951 UN Convention on the Status of Refugees and the 1967 Protocol to that Convention, the European Convention of Human Rights (ECHR) and/or the Charter of Fundamental Rights of the Union (CFR). Subsidiary protection (outside the scope of the Convention) also challenges harmonization, with the ECJ requiring divergence not to encroach the refugee<sup>29</sup>. The evolutionary

---

<sup>17</sup> Regulation (EC) 810/2009 establishing a Community Code on Visas (Visa Code), OJ L 243, 1–58, Article 32.3.

<sup>18</sup> Convention implementing the Schengen Agreement between the Governments of the States of the Benelux Economic Union, the Federal Republic of Germany and the French Republic on the gradual abolition of checks at their common borders, Official Journal L 239, 22/09/2000 P. 0019 – 0062, Article 26; Directive 2004/82/EC on the obligation of carriers to communicate passenger data, OJ L 261, 24–27.

<sup>19</sup> Directive 2002/90/EC defining the facilitation of unauthorised entry, transit and residence, OJ L 328, 17–18.

<sup>20</sup> Directive 2011/36/EU on preventing and combating trafficking in human beings and protecting its victims, and replacing Council Framework Decision 2002/629/JHA, OJ L 101, 1–11.

<sup>21</sup> Regulation (EU) 2019/1240 on the creation of a European network of immigration liaison officers, PE/50/2019/REV/1, OJ L 198, 88–104.

<sup>22</sup> Directive 2004/81/EC on the residence permit issued to third-country nationals who are victims of trafficking in human beings or who have been the subject of an action to facilitate illegal immigration, who cooperate with the competent authorities, OJ L 261, 19–23.

<sup>23</sup> Directive 2001/83/EC on the Community code relating to medicinal products for human use, OJ L 311, 67.

<sup>24</sup> Directive 2009/50/EC on the conditions of entry and residence of third-country nationals for the purposes of highly qualified employment, OJ L 155, 17–29.

<sup>25</sup> Directive 2014/36/EU on the conditions of entry and stay of third-country nationals for the purpose of employment as seasonal workers, L 94/375.

<sup>26</sup> Directive 2014/66/EU on the conditions of entry and residence of third-country nationals in the framework of an intra-corporate transfer, OJ L 157, 1–22.

<sup>27</sup> Directive 2003/86/EC on the right to family reunification, OJ L 251, 12–18.

<sup>28</sup> Directive 2008/115/EC on common standards and procedures in Member States for returning illegally staying third-country nationals, OJ L 348, 98–107.

<sup>29</sup> Case C-57/09 and C-101/09 *B and D* [2010] ECR I-10979.



accumulation of safeguards from the Treaty of Amsterdam (Article 63.1 and 2 EC), the Tampere European Council 1999 establishing first face of CEAS the Directive on qualification and content of refugee and subsidiary protection (QD and QD recast), on application procedures<sup>30</sup> and on allocation of responsibility for asylum-seeker to among MSs<sup>31</sup>, the Eurodac<sup>32</sup> and temporary protection in the event of a mass influx<sup>33</sup>, to the Hague Programme, focused on objectives to raise the level of protection and reducing the divergences on recognition rates and finally, the Lisbon Treaty, the CEAS appears more comprehensive. Article 78 TFEU marked this second phase of legislation (QD, Directive on asylum procedures, revised Dublin Regulation, revised Eurodac Regulation, European Asylum Support Office), where the ECJ gained a significant role.

### **B. The AFSJ in the frame of the Treaties and beyond: substantive aspects**

In substantive terms, Article 18 and Article 19 CFR follow the outer values of inherence, universality, inalienability, and indivisibility of human rights. In practical terms, they serve the legitimate public interest of an AFSJ without internal frontiers, in which the free movement of persons is ensured, and where appropriate measures on external border controls, asylum, immigration, and the prevention and combat of crime, are the most effective for the policy goal and the least onerous for the protected individual. Notwithstanding the association of the AFSJ with the constitutional law due to the significance of the policies to the individual (Monar, 2009), the prevailing rule of law and the fundamental rights legacy, strengthened by the adherence to the ECHR, bound the MSs to a conformity alignment even in the absence of explicit legal remedies (Halter, 2007).

Admittedly, primary EU law defends the disadvantaged (Mestmacker, 1995) who mostly fear the implications of disengagement from this democratic reassurance. In that sense, EU law pulls matters out of the exclusive grip of politics and negotiation and subjects them to a system of integration through law. The fragmentary and sparsely written character of the Treaties appoints the Court to pave the way. The Court's interpretative methodology has upright functional consequences for fashioning political choices about the nature of the policies. Replacing national regulation with a single EU model carries a profound re-regulatory potential. Policing has sharpened under the claim to have created a system of special protection through the means of supremacy and direct effect, supplemented by State and private liability and imbued by the principles of good administration and fundamental rights (Habermas, 2015).

---

<sup>30</sup> Directive 2013/32/EU on common procedures for granting and withdrawing international protection, OJ L 180, 60–95, as applicable currently.

<sup>31</sup> Regulation (EC) 343/2003 establishing the criteria and mechanisms for determining the Member State responsible for examining an asylum application lodged in one of the Member States by a third-country national, OJ L 50, 5.2.2003, 1–10.

<sup>32</sup> Regulation (EC) 2725/2000 concerning the establishment of 'Eurodac' for the comparison of fingerprints for the effective application of the Dublin Convention, OJ L 316, 1–10.

<sup>33</sup> Directive 2001/55/EC on minimum standards for giving temporary protection in the event of a mass influx of displaced persons and on measures promoting a balance of efforts between Member States in receiving such persons and bearing the consequences thereof, OJ L 212, 12–23.

The premise of human rights is not exhausted in the precise provisions of Article 18-19 CFR but includes a longstanding judicial tradition and a concrete political regime (Rosas & Armati, 2010), thus combining legal and institutional for guarantees. Despite the rejection of the explicit justiciability of the Charter, the EU provides a multitude of intimately linked sources and principles affecting and protecting the individual. Within this framework, the Court appears to be the actor, which by virtue of the principle of supremacy, has instrumentalized the human rights in an attempt of implicit constitution-making, governed by legitimacy and coherence. The need to apply and interpret secondary law in conformity with fundamental rights was stressed throughout the jurisprudence<sup>34</sup> with reference to the then non-binding CFR. The Court has also had the opportunity to confirm, in relation to a provision on what is called subsidiary protection, that Union law is not limited to the minimum requirements laid down in international instruments such as ECHR and may, therefore, go further<sup>35</sup>.

### **C. The constitutional foundations of EU's legal system in the ECJ's jurisprudence**

Direct effect is a judge-made principle to extend the enforceability of EU law provisions before national courts, by imposing direct obligations on their subjects. While EU primary law in force is always directly applicable, not only by Union institutions but also within the MS' legal orders (Rosas & Armati, 2010). The situation is different within secondary law, ranging namely from the Regulations' general application and precedence to Directives in need of adequate transposition into the national law, and binding as to the result to be achieved (Article 288 TFEU). The invocability of a Regulation or a Directive as the sole source of a right that would not otherwise exist unveils the opportunity to an individual to rely on a specific provision of the treaties, secondary legislation, decisions or international agreement, properly interpreted, before the courts or tribunals of MS, thereby ensuring a uniform application where a provision has not or not properly been incorporated or applied at the national level (Fennelly, 2013) when it the provision is designed to confer rights on an individual<sup>36</sup> unconditionally and in a sufficiently precise way - irrespective of the transposition thereof<sup>37</sup>. The direct effect of a provision can, and in certain circumstances, should be raised by the national court or tribunal even where none of the parties has done so<sup>38</sup>.

This scheme is apocalyptic of the compliance of MSs with their obligations, and the response of the central institutions to the alleged violations. Besides, even though only Regulations are directly applicable, Directives can also have direct vertical effects provided the three criteria listed above are fulfilled, and the Directive has not been transposed into national law in a timely or correct way<sup>39</sup>. This is of considerable importance for the CEAS, which, except for two Regulations, consists of Directives. The principle of direct effect, moreover, ensures the uniform application of EU law in cases where a MS fails to implement a Directive in its national legislation by the stated time-limit or fails to implement it correctly. Even though provisions of a Directive cannot be directly effective

---

<sup>34</sup> Case C-540/03 *Parliament v Council* [2006] ECLI:EU:C:2006:429 para.70.

<sup>35</sup> Case C-465/07 *Elgafaji* [2009] ECLI:EU:C:2009:94 paras.28 and 44.

<sup>36</sup> Case C-194/94 *CIA Security* [1996] ECLI:EU:C:1996:172 paras.42-44.

<sup>37</sup> Case C-176/12 *Association de médiation sociale* [2014] ECLI:EU:C:2014:2 para.31.

<sup>38</sup> Case C-72/95 *Aannemersbedrijf* [1996] ECLI:EU:C:1996:404 paras.57-60.

<sup>39</sup> Case C-148/78 *Ratti* [1979] ECLI:EU:C:1979:10 paras.19-23.

before the deadline for implementation<sup>40</sup>, but the MSs remain during that time under the obligation to “refrain from taking any measures liable seriously to compromise the attainment of the result prescribed by [the] directive”<sup>41</sup>.

Cases of conflict between EU law and domestic law are to be resolved according to the principle of supremacy, which provides that the first takes precedence over any incongruous national legislation. This principle flows from the distinct nature of the EU legal order “for whose benefit the MSs have limited their sovereign rights, albeit within limited fields”<sup>42</sup>. In the norm conflict, EU law thus prevails over pre-existing and subsequent legislation of the MSs, rendering it automatically inapplicable<sup>43</sup> in the sense that courts are obliged to set aside the provision concerned and apply EU law until the national legislation is amended accordingly<sup>44</sup>. The principle of supremacy of EU law thus aims to maintain “the effectiveness of obligations undertaken unconditionally and irrevocably [...] pursuant to the treaty and [...] the very foundations of the Community”<sup>45</sup>.

Such comprehensive bottom-up interpretation is observed at the detention of irregular migrants. The ECJ has delicately oriented the rationales of the measure exclusively towards deterrence, where there is a reasonable fear of absconding intend. Arguments derive from Article 5.1.f ECHR and call for due diligence<sup>46</sup> performance. The same extraordinariness applies to the Returns Directive, namely only “when there is a risk of absconding or if the person concerned avoids or hampered the return or removal process unless other sufficient but less coercive measures can be applied”. The arsenal would render void if there were not at the most primitive stages need for fully justified and in writing administrative or judicial orders, subject to speedy legality review, supported by legal representatives and consular authorities. Further, the detention would not be proportionate if it would not be separated from ordinary prisoners<sup>47</sup>.

The Court’s zealous in preserving its human rights legacy in cases of operational and structural failures is evident in cases, such as *Kadzoev* ruling<sup>48</sup> on the farthest time limits of detention considering the time spent as a detainee before the application of the Directive and extracting the period of detention while judicial review is pending. The same reasoning emerges in *Sagor* on the exclusion of fines from the scope of the Directive and the granting of a chance of voluntary departure<sup>49</sup>. From a review of this case-law, it follows that the Directive requires an individual assessment of the detention conditions, which are not indicatively, “in particular”, listed

---

<sup>40</sup> I Case C-148/78 *Ratti* [1979] ECLI:EU:C:1979:10 paras.19-23..

<sup>41</sup> Case C-148/78 *Ratti* [1979] ECLI:EU:C:1979:10, para.22; Case C-144/04 *Werner Mangold* [2005] ECLI:EU:C:2005:70 para.67.

<sup>42</sup> Case 6/64 *Costa v ENEL* [1964] ECLI:EU:C:1964:66 para.593.

<sup>43</sup> Case 11/70 *Internationale Handelsgesellschaft* [1970] ECLI:EU:C:1970:114 para.3.

<sup>44</sup> Joined cases C-231 to C-233/ 06 *Office national des pensions* [2007] ECLI:EU:C:2007:373 para.41.

<sup>45</sup> Case 106/77 *Simmenthal* [1978] ECR 1978-00629 para.18.

<sup>46</sup> *Mikolenco v. Estonia* App no. 12157/05 (ECHR, 25 June 2009) paras.37-42.

<sup>47</sup> Joined Cases C-473/13 and C-514/13 *Bero and Bouzalmate* [2014] ECLI:EU:C:2014:2095 paras.30-32.

<sup>48</sup> Case C-357/09 PPU *Kadzoev* [2009] ECLI:EU:C:2009:741 para.56.

<sup>49</sup> Case C-554/13 *Zh. and O.* [2015] ECLI:EU:C:2015:377 paras.43-46.

following the “principle of gradation”, namely a process starting with the most liberty to a justified restriction where necessary for establishment of the identity and the immigration status of the person concerned.

In *European Parliament v. Council*, the EP instigated annulment proceeding against certain provisions of the Family Reunification<sup>50</sup>, on the grounds that human rights were not sufficiently protected; the insistence on a three-year wait for a family reunion and the exclusion of certain categories of children. The application might have been rejected but it offered another instance of the relevance of ECHR into the EU legal order. The right to family does not guarantee a general right to admission of family members into the host State, as, despite the higher standards set by the Directive, the MSs are allowed to make access to or pursuit of integration in their territory contingent upon specific qualifications, the detailed application of the examinations and the status resting on their regulatory sovereignty. In the background of these questions is the extent to which national integration policies undermine the *effet util* or effectiveness of these very directives by way of disrupting the normal development of family life in a stable and secured frame. In several cases, it has been stated that the overall scheme aims to facilitate and promote family reunification instead of implicitly imposing migration-control barriers by filtering family reunification cases<sup>51</sup>.

### III. Global constitutionalism

It is argued that the multidimensional nature of the AFSJ goes beyond the policy framework and is principally woven within the international community and, consequently, with public international law. Indeed, the norms applied in the AFSJ inevitably produce the intertwining of EU law with public international law in its broadest sense (Thym, 2013). Not surprisingly, but very interestingly for the research, this does not solely affect the external dimension of the AFSJ policies but also very increasingly the substance of the norms and principles of the internal policies on the matter. This value system tendency is under examination at this point; the supporting ideas of policies and the legal argumentations of the Court. Besides, the global mutations supposedly illustrate the integrational progress within the EU from intergovernmentalism to communitarization and from economic synergy to an ever-closer union among the peoples of Europe. The EU is not only a paradigm of global constitutionalism itself (Shaw, 2017) but is also located in a nexus of broader such paradigms, through which it evolves.

The expansion of the ideological horizons of the Union’s competences is also a result of legacy and of lessons, especially those after World War II. Global constitutionalism theory describes a global commitment to the rule of law, democracy, and human rights, as inherited by the American and French Revolutions not only in newly established state constitutions but also as a mechanism for assessment, interpretation, and progressive development of law beyond the State.

---

<sup>50</sup> Case C-554/13 Zh. and O. [2015] ECLI:EU:C:2015:377 paras.55.

<sup>51</sup> Case C-578/08 *Chakroun* [2010] ECLI:EU:C:2010:117 para.43; Case C-153/14 *K and A* [2015] ECLI:EU:C:2015:453, para.57.

This section aims to underline the effectiveness and fairness promise of the identification and the function of upper constitutional law by its recipients the State – the EU citizen and the TCN. In this attempt, State sovereignty is only ontologically necessary, as it suffices that human rights and accountability form rights and obligations at a supranational level, whether this is the EU or the international legal order. The hermeneutic legacy of global constitutionalism applied in our case interrogates how and why the States have given their consent for majoritarian decision making, whether this has been effective for people's representation (Oeter, 2009) and prosperity.

Consequently, as in the scholarship on which we draw, the following division corresponds to the so-called global constitutional trinity: democracy (requirement and objective, goal, legitimacy, necessity – limitation of powers), human rights (goal and requirement), the rule of law (strategy for safeguarding democracy and human rights).

#### **A. Democratic legitimation beyond the State: institutions, procedures and standards interpretation, development or reform**

Since the key element of any constitution is how it is respected and how that responsibility is secured, the research is oriented toward the institutions and the position of individual before them.

In the institutional realm, popular sovereignty, democracy and direct accountability to the people, marked the shift from “political constitutionalism” to “democratic constitutionalism”, where the individual is entitled reasonably disagree about substantive outcomes since the democratic process including the judiciary, is the most legitimate and effective one. Seemingly, Article 1 TEU provides for “the process of creating an ever closer union among the peoples of Europe, in which decisions are taken as openly as possible and as closely as possible to the citizen”, and Article 11.4 TEU affords a right to citizens to take the initiative of inviting the Commission to submit a proposal when a legal act is allegedly required. Nevertheless, as *Anne Peters* has observed there are no self-evident hierarchies, but instead the project is continuously transformative because it does not use a domestic analogy, but instead, new criteria to comprehend the creation and legitimacy of law, and to improve the effectivity and the fairness of the international legal order. I, therefore, assume that the evaluation shall not only follow internal norms and scopes, but mainly overarching global qualities. Further, functionally, the adoption of OLP, together with the recognition of the ECJ’s competence, fuelled in no small extent integration and human rights protection.

Despite the resistance of static perceptions expressed also in opt-outs and opt-ins (Denmark, Ireland, UK, Ireland, Norway, and Switzerland), competence sharing under Article 4.2j TFEU, enabled a plethora of Commission initiatives (Article 76 TFEU) in a coordinated nexus of multilevel governance basis to share responsibility in regulating external border controls (Article 77). In recognition of the fact that border control is in the interest of all MSs and not solely of the one whose borders are in danger, and presaging the principles of solidarity and fair sharing of responsibility, border guards assist the MSs confronted with an urgent and

exceptional situation, such as massive influx of immigrants. Additionally, Article 78 and Article 18 CFR expressly embrace the Geneva Convention and relative international patterns (von Bogdany, 2009).

It is thus reiterated that uniformity does not only affect the operational commitments as to the common interest in external border controls as a corollary to abolishing internal border checks, obviating the potential of forum shopping by asylum seekers but also to the principles-driven regulation of the entry and residence conditions, residence permit as *de facto* citizenship (Thym, 2014), rights and procedural safeguards benefiting TCN, focus on family reunification and measures promoting integration.

Bearing in mind the words of the German constitutional lawyer *Josef Isensee*, according to whom to encapsulate the law of the constitution in a written document bequeaths on that law a special dignity, publicity, popularity, and durability (Isensee, 2014), and thus, establishes a *substantive constitution* (Tomuschat, 1999: 88) the latter shall be asserted with the Treaty of Lisbon paradigm. It is there that the *constitutionalism* concept can be identified in the normative perspective of a political scheme, applied beyond state margins, frame of mind, the structure of thought comprising three ideas: power limit, the guarantee of rights, and legitimate authority.

Within this framework, the derivation and cruciality of the general principles of EU law, namely values for a wished society in which “*pluralism, non-discrimination, tolerance, justice, solidarity, and equality between women and men prevail*” paves the way. That proposition intimates and absolves the continuation of mutual trust within the management of interdependence. Either of and by the MSs or by the people, rules on the foundation of the Treaties comprehended as a system actively constitutionalized by the Court recognize discourse of individual rights, far from mere State interests and control the infliction of costs externally.

## **B. Theoretical and historical questions: history and theory of European integration, the regulation of the AFSJ through the lens of human rights**

Although most post-second World War constitutions have laid down elements that set them apart, most also have a common core of human rights provisions that are strikingly similar, and this is not merely coincidental. Further, since universal values, such as fundamental refugee rights, seem too vague in the international Treaties and the TEU, the TFEU, does the formal acceptance of secondary law actually and/ or domestic law initiate a new effectiveness trigger in terms of constitutionalization?

In this chapter the formation of periodization will demonstrate historical moments and events by which global constitutionalists shape the world. It would also indicate conceptual and pragmatic arguments of cosmopolitanism on the transcendence of the dichotomy between the international and national orders and comprehension of law as a phenomenon that also occurs or should occur at the global field. One of the most striking illustrations of how far beyond purely economic integration the EU has developed is the creation of what since the Treaty of Amsterdam has been termed AFSJ (Kostakopoulou, 2009; Piri, 2006; Walker, 2004). The first steps in the formation of the AFSJ law followed the intergovernmental scheme, noticeably outside

the EU institutional framework (Council of Europe and the Hague Conference on Private International Law). The action was limited in scope, except for the Schengen Agreement's enthusiasm towards the abolishing of internal border controls. Notwithstanding the then ancillarization compared to the internal market and the economic freedoms, the policy brought into the Treaty framework as the Third Pillar at the Maastricht and the Amsterdam Treaties heralded a more supranational approach to some elements.

Cooperation predating the entry into force of the Lisbon Treaty evolved at variable speeds and has blended intergovernmental and integrationist elements in a unique way (Kostakopoulou, 2009). On legal grounds, step-change appears, for instance, from the comparative reading of the Treaty wording, namely the difference between the former Article 3d TEC and Article 2 TEU (Rosas & Armati, 2010), upsetting the self-determination and future of the Union (Lenaerts, 2010). Further, the systematic precedence of the issue by inclusion among the objectives (Rosas & Armati, 2010), and the TFEU (contrariwise, fisheries are situated before immigration) demonstrate its significance to the substantive notion of "Area".

Consequently, notwithstanding numerous criticisms for the alleged harm of the abolition of frontiers to security (Kostakopoulou, 2009; Monar, 2009; Rosas & Armati, 2010), the regulation at stake does not solely aim at border control and geographic framing, but chiefly to guarantee the full enjoyment of a fully-fledged free movement, where both the EU citizen and the alien relish the fruits of a functioning internal market (Rosas & Armati, 2010). Again, the structural disposition of the primary law exposes the integrational aspiration, this time by Article 21 TFEU in Part 2 of non-discrimination and citizenship; the Union citizens are not the only ones to benefit from free movement.

The methodology of global constitutionalism is thus, more flexible and pluralistic, as venue shopping is possible with the aim to inspire rational policymakers from new venues of policy-making more amenable to their preferences and goals. It is also more adequate in a Union where *per definitionem* unity is absent, as it introduces a simplified, compact order. It is adequate also because mere reliance on formal constitutionalism postpones concrete debates on current and urging challenges. It is also more unifying, as additive features coincide to holistic coordination of interests anchored in liberties and social capital.

### **C. Common standards on the rule of law, democracy and human rights**

As suggested above, the global constitutionalism theory defines the strange multiplicity of those affected by global norms (Tully, 1995). From the individual's perspective, the EU's object and tenacity consist of subjecting cross-border issues to democratic regulation without having to submit to a single European super-state. According to the theory of democratic intergovernmentalism, constitutional norms are legitimate if they spring from a legitimate method of treaty-making amidst liberal authorities who submit their legal agreements for legislative confirmation. Considering this normative principle, the empirically prevailing schemes, which make international law-making an executive-centred force, and despite the alleged distance between international negotiators and the citizens or the unequal distribution of power among governments, it seems

that there is nothing fundamentally wrong with current practice, as declared in the *Kadi case*<sup>52</sup> concerning the supremacy of fundamental rights in the (global) normative order.

The idea is not an innovative one; *Alfred Verdross* (1890-1980), in his book on the sources of international law published in 1973, marked in the chapter named *the constitution of the universal international legal community* three conceivable sources of an international constitutional law:

Informal state consensus,

customary law,

treaty law,

which albeit constitute a formal and a material (or substantive) constitution.

In that sense, global constitutionalism challenges the power of global political institutions by determining the occurrence of an unwritten international charter on the issues falling under the border checks, asylum and immigration binding for the EU. Global constitutionalism theory stoves off democratic deficits (Thym, 2013) and overly powerful courts of global governance and the danger of denormalization by some abstract higher legitimacy in opposition to and in violation of international legality. It denotes a discourse in the international debate, the intent of which is the application of constitutional principles in the global display to realize the worldly guarantee of human rights<sup>53</sup>. It is a discourse of synchronized descriptive, hermeneutic, and normative dimension (Law & Versteeg, 2011) and as such, attempts to enclose in the EU sphere of influence with regards to ethics, accountability, principles, integrity and values.

A significant part of these notions is related to neighbouring disciplines such as political science, sociology or philosophy. Considering these reflections, the objective of this work will dispense the challenges that cosmopolitan Constitutionalism substantiates for the classic debates on integration in the light of the current conditions of the international sphere. There is no central State or quasistate form which does not presume a chief power; in Europe, higher-level defeats the lower level, but the source of normative authority and of actual power originates instead from the more profound level, State and people. Not to displace the States, but to manage their interdependence to deter the MSs from inflicting external costs and circumventing transnational problems. Similarly, the motivating intensity of interdependence as an inducement to cooperation is not discharging the global commitment to values, instead of obsessing with the autonomy of the EU legal order and of the jurisdiction of the Court.

Consequently, the globality of these axioms is considered in terms of geographical spread, depth, and multicultural derivation of the principle examined. The creation and observance of these institutions stem from a process of exchange of knowledge, approximation of institutions and cross-fertilization, both vertically, and horizontally. Notwithstanding the particularities of the integration process, not only it certainly presents

---

<sup>52</sup> Joined Cases C-402/05 P and C-415/05 P *Kadi* ECR 2008 I-06351 para.307.

<sup>53</sup> Case 4/73 *Nold* [1974] ECR1974 00491 para.13.



elements of the idea, but also should deepen its connection with the outside world. The AFSJ offers such an opportunity. It constitutes the very example of a series of a bottom-up regulatory framework, which synchronically with the case-law of the ECJ and the ECtHR establish an (united) bulk of international constitutional rules. Thus, this perception would help not only in the interpretation of the existing legal norms thereof but also signalize novel solutions *de lege ferenda*.

For these reasons, among the perceived constitutional norms included in the relevant law, for methodological purposes described below, this research focuses on the interpretation of the law in terms of adequate protection of human rights. This approach is necessarily associated with the primary law of the EU and the need for operational effectiveness - through suppressing the insular refusal to acknowledge when the assertion of difference inflicts external costs on neighbours - to yield precise outcomes internationally. The conclusions will be complemented by standardizing concerns of an evaluative systematization and evaluating closure of statutory gaps.

### **The proposed solution**

Building upon the hermeneutic function and the constitutional character of international area proposed by *Peters* and *Ferrajoli* respectively, as well as the perception of democracy drawn by *Habermas* and the rational choice institutionalism (Craig, 2020) as for the significance of institutions, this research proposal seeks to list the depiction of constitutionalism in the AFSJ and to analyse the particular importance of such finding for the institutional and substantive parts of the integration agenda. As already mentioned, global constitutionalism is a hypothesis, an exegesis and the solution. On the one hand, it has been indicated that a supranational polity gradually transformed in a Union, global values, such as democracy, human rights and the rule of law have been instrumentally embodied in the written and unwritten Constitution (Shaw, 2017). On the other hand, the restorative effect of global constitutionalism awaits its turn to adjust the anomalies and misconceptions arisen due to the crisis or the cowardliness (Thym, 2019) to meaningful integration.

Such vision serves to introduce a different orientation and consensus furthering the antinomic unity by departing from methods of analysis based solely on programmatic documents and declared strategies. The merging of the two legacies of constitutionalism will reveal continuity and innovation. I intentionally exclude the issue of constituent power based on the assumption that the historical background and development of the case law, by recognizing the scope of application of fundamental rights as general principles restricting the acts of Union institutions and the domestic holds far more *pouvoir constituant* than a Treaty amendment (Patberg, 2017).

To sum up, the research suggests that the *constitutional* framework as applicable, defines its essence as such, and in relation to historical advancements, and ultimately, can enhance the potential of rigorous corrective doctrinal consolidation. The above perceptions conditioned the methodological features of my proposal.

Firstly, it has been shown that the principal characteristics of the European and global constitutionalism affect Asylum and Immigration. In that way, the historical evolution and the emerging perspective, as well as the position of international law in the evolution of the Union overtime signify customary primacy and unamendability as a piece of the constitutional charter.

The second part appeared more constructive, as it addressed the institutional structure of the issue, reflecting inter alia, on efficiency, institutional balance, MSs' interests, and uniformity. Following *J.H.H. Weiler*'s, in "*The transformation of Europe*" thoughts, two critical structural dimensions of constitutionalism of the nonunitary polity have been merged: (a) the relationships between legal norms and policies of the centre and the periphery; and (b) the principle governing the division of material competences between the EU and the MSs, usually alluded to as the doctrine of enumerated powers.

## References

- Craig, P. (2020). Development of the EU. In: C. Barnard and S. Peers (eds.), *European Union Law*. Oxford: Oxford University Press, pp.34-35.
- Desmet, E. (2020). Methodologies to study human rights law as an integrated whole from a users' perspective: lessons learnt. In: E. Brems, S. Ouald-Chaib (eds.), *Fragmentation and Integration in Human Rights Law Users' Perspectives*. Cheltenham: Edward Elgar Publishing.
- Fennelly, N. (2013). The National Judge as Judge of the European Union. In: CJEU (ed.), *The Court of Justice and the Construction of Europe: Analyses and Perspectives on Sixty Years of Case-Law*, Asser Press, pp.64-65.
- Habermas, J. (2015). Democracy in Europe: Why the Development of the EU into a Transnational Democracy Is Necessary and How It Is Possible. *European Law Journal*, 21: 546-555.
- Halter, U. (2007). Rechtsschutz in der dritten Säule der EU. *Juristen – Zeitung*, 62 (15): 772.
- Isensee, J. (ed.) (2014). Legitimation des Grundgesetzes [The legitimation of the German Fundamental Law], in: J.Isensee, P. Kirchhof (eds.), *Handbuch des Staatsrechts der Bundesrepublik Deutschland*, 12 (3): 43.
- Kaunert, C., Leonard, S. (2012). The Development of the EU Asylum Policy: Revisiting the Venue shopping Argument. *Journal of European Public Policy*, 19 (9): 1396-1413.
- Kostakopoulou, D. (2009). The Area of Freedom, Security and Justice and the European Union's Constitutional Dialogue. In: C. Barnard (ed.), *The Fundamentals of EU Law Revisited: Assessing the Impact of the Constitutional Debate* Oxford: Oxford University Press, 2009, pp. 156-64.
- Law, D. and Versteeg, M. (2011). The Evolution and Ideology of Global Constitutionalism. *California Law Review*, 99 (5): 1163-1257.
- Lenaerts, K. (2010). The Contribution of the European Court of Justice to the Area of Freedom, Security, and Justice", *International and Comparative Law Quarterly*, 59 (2): 255-301.
- McCrudden, C. (2000). A Common Law of Human Rights? Transnational Judicial Conversations on Constitutional Rights. *Oxford Legal Studies*, 20: 516-527.
- Mestmacker, E. (1994). On the legitimacy of European Law. *RechtsZ*, 58: 615–636.
- Monar, J. (2009). The Area of Freedom, Security and Justice. In: A. Von Bogdany, J. Bast (eds.), *Principles of European Constitutional Law*. Hart, CH Beck: Nomos, pp. 580.
- Oeter, S. (2009). Federalism and Democracy. In: A. von Bogdany, J. Bast (eds.), *Principles of European Constitutional Law*. Hart, CH Beck: Nomos, pp.63-68.
- Patberg, M. (2017). The Levelling Up of Constituent Power in the European Union. *Journal of Common Market Studies*, 55: 2-6.
- Peters, A. (2006). Compensatory constitutionalism: The function and potential of fundamental international norms and structures. *Leiden Journal of International Law*, 19 (3): 579-610.
- Piris, J-J.C. (2006). *The Constitution for Europe: A Legal Analysis*. Cambridge: Cambridge University Press.
- Rosas, A. & Armati, L. (2010). *EU Constitutional law*. Oxford: Hart Publishing.
- Shaw, J. (2017). The European Union and global constitutionalism. *University of Edinburgh School of Law, Research Paper Series*, No 2017/02.

- Thym, D. (2013). Towards International Migration Governance? The European Contribution, In: B. Van Vooren, S. Blockmans J. Wouters (eds.), *The Legal Dimension of Global Governance: What Role for the EU?* Oxford: Oxford University Press, pp.291-292.
- Thym, D. (2014). Residence as De Facto Citizenship? Protection of Long-Term Residence under Article 8 ECHR. In: Ruth Rubio-Marin (ed.), *Human Rights and Immigration*. Oxford: Oxford University Press, pp.113-117.
- Thym, D. (2016). Ambiguities of Personhood, Citizenship, Migration and Fundamental Rights in EU Law. In: L. Azoulay, S. Barbou des Places, E. Pataut (eds.), *Constructing the Person. Rights, Roles, Identities in EU Law*, Oxford: Hart publishing, pp.118-124.
- Thym, D. (2019). Between Administrative Mindset and Constitutional Imagination: The Court of Justice in Immigration, Asylum and Border Control Policy. *European Law Review*, 44: 139-158.
- Tomuschat, C. (1999). International Law: Ensuring the Survival of Mankind on the Eve of a New Century. In: *Collected Courses of the Hague Academy of International Law*, 281 (9).
- Tully, J. (1995). *Strange Multiplicity: Constitutionalism in an Age of Diversity*. Cambridge, New York: Cambridge University Press.
- Von Bogdany A. (ed.) (2009). Founding principles. In: A. von Bogdany, J. Bast (eds.), *Principles of European Constitutional Law*. Hart, CH Beck: Nomos: pp.14-15.
- Walker N. (ed.) (2004). *Europe's Area of Freedom, Security and Justice*. Oxford: Oxford University Press.
- Weiler J.H.H. (1991). The transformation of Europe. *The Yale Law School Journal*, 100 (8): 2428.

### Table of Cases

- Case 106/77 *Simmenthal* [1978] ECR 1978-00629.
- Case 11/70 *Internationale Handelsgesellschaft* [1970] ECLI:EU:C:1970:114.
- Case 294/83 *Les Verts* [1986] ECLI:EU:C:1986:166.
- Case 4/73 *Nold* [1974] ECR1974 00491.
- Case 6/64 *Costa v ENEL* [1964] ECLI:EU:C:1964:66.
- Case C-144/04 *Werner Mangold* [2005] ECLI:EU:C:2005:70.
- Case C-148/78 *Ratti* [1979] ECLI:EU:C:1979:10.
- Case C-153/14 *K and A* [2015] ECLI:EU:C:2015:453.
- Case C-176/12 *Association de médiation sociale* [2014] ECLI:EU:C:2014:2.
- Case C-194/94 *CIA Security* [1996] ECLI:EU:C:1996:172.
- Case C-31/09 *Bolbol* [2010] ECLI:EU:C:2010:351.
- Case C-355/04 P *Segi* [2007] ECLI:EU:C:2007:116.
- Case C-357/09 PPU *Kadzoev* [2009] ECLI:EU:C:2009:741.
- Case C-465/07 *Elgafaji* [2009] ECLI:EU:C:2009:94.
- Case C-481/13 *Qurbani* [2014] ECLI:EU:C:2014:2101.
- Case C-540/03 *Parliament v Council* [2006] ECLI:EU:C:2006:429.
- Case C-554/13 *Zh. and O.* [2015] ECLI:EU:C:2015:377 paras.43-46.
- Case C-57/09 and C-101/09 *B and D* [2010] ECR I-10979.
- Case C-575/12 *Air Baltic* [2014] ECLI:EU:C:2014:2155.
- Case C-578/08 *Chakroun* [2010] ECLI:EU:C:2010:117.
- Case C-72/95 *Aannemersbedrijf* [1996] ECLI:EU:C:1996:404.
- Joined cases C-231 to C-233/ 06 *Office national des pensions* [2007] ECLI:EU:C:2007:373.
- Joined Cases C-402/05 P and C-415/05 P *Kadi* ECR 2008 I-06351.
- Joined Cases C-411/10 and C-493/10 *NS*, [2011] ECLI:EU:C:2011:865.
- Joined Cases C-473/13 and C-514/13 *Bero and Bouzalmate* [2014] ECLI:EU:C:2014:2095.
- Mikolenko v. Estonia* App no. 12157/05 (ECHR, 25 June 2009).
- Opinion 2/13, Accession of the European Union to the European Convention for the Protection of Human Rights and Fundamental Freedoms, ECLI:EU:C:2014:2454.

### Legal texts

- Convention implementing the Schengen Agreement between the Governments of the States of the Benelux Economic Union, the Federal Republic of Germany and the French Republic on the gradual abolition of checks at their common borders, Official Journal L 239, 22/09/2000 P. 0019 – 0062, Article 26; Directive 2004/82/EC on the obligation of carriers to communicate passenger data, OJ L 261, 24–27.

- Directive 2001/55/EC on minimum standards for giving temporary protection in the event of a mass influx of displaced persons and on measures promoting a balance of efforts between Member States in receiving such persons and bearing the consequences thereof, OJ L 212, 12–23.
- Directive 2001/83/EC on the Community code relating to medicinal products for human use, OJ L 311, 67.
- Directive 2002/90/EC defining the facilitation of unauthorised entry, transit and residence, OJ L 328, 17–18.
- Directive 2003/86/EC on the right to family reunification, OJ L 251, 12–18.
- Directive 2004/81/EC on the residence permit issued to third-country nationals who are victims of trafficking in human beings or who have been the subject of an action to facilitate illegal immigration, who cooperate with the competent authorities, OJ L 261, 19–23.
- Directive 2004/83/EC on minimum standards for the qualification and status of third-country nationals or stateless persons as refugees or as persons who otherwise need international protection and the content of the protection granted.
- Directive 2008/115/EC on common standards and procedures in Member States for returning illegally staying third-country nationals, OJ L 348, 98–107.
- Directive 2009/50/EC on the conditions of entry and residence of third-country nationals for the purposes of highly qualified employment, OJ L 155, 17–29.
- Directive 2011/36/EU on preventing and combating trafficking in human beings and protecting its victims, and replacing Council Framework Decision 2002/629/JHA, OJ L 101, 1–11.
- Directive 2011/95/EU on standards for the qualification of third-country nationals or stateless persons as beneficiaries of international protection, for a uniform status for refugees or for persons eligible for subsidiary protection, and for the content of the protection granted (recast).
- Directive 2013/32/EU on common procedures for granting and withdrawing international protection, OJ L 180, 60–95.
- Directive 2014/36/EU on the conditions of entry and stay of third-country nationals for the purpose of employment as seasonal workers, L 94/375.
- Directive 2014/66/EU on the conditions of entry and residence of third-country nationals in the framework of an intra-corporate transfer, OJ L 157, 1–22.
- Proposal for a Regulation amending Regulation (EC) No 562/2006 in order to provide for common rules on the temporary reintroduction of border control at internal borders in exceptional circumstances, COM.
- Regulation (EC) 2725/2000 concerning the establishment of 'Eurodac' for the comparison of fingerprints for the effective application of the Dublin Convention, OJ L 316, 1–10.
- Regulation (EC) 343/2003 establishing the criteria and mechanisms for determining the Member State responsible for examining an asylum application lodged in one of the Member States by a third-country national, OJ L 50, 5.2.2003, 1–10.
- Regulation (EC) 562/2006 establishing a Community Code on the rules governing the movement of persons across borders (Schengen Borders Code), OJ L 105, 1.
- Regulation (EC) 810/2009 establishing a Community Code on Visas (Visa Code), OJ L 243, 1–58, Article 32.3.
- Regulation (EU) 1051/2013 *amending Regulation (EC) No 562/2006* in order to provide for common rules on the temporary reintroduction of border control at internal borders in exceptional circumstances, OJ L 295, 1; Council Regulation (EU) No 1053/2013 establishing an evaluation and monitoring mechanism to verify the application of the Schengen acquis, OJ L 295, 27–37.
- Regulation (EU) 2019/1240 on the creation of a European network of immigration liaison officers, PE/50/2019/REV/1, OJ L 198, 88–104.

## 6.5. Refugees' social and economic integration prospects in Greece: A case study in Lesbos and Crete islands

*Dimitrios Kotroyannos<sup>1</sup>, Stylianos Ioannis Tzagkarakis<sup>2</sup>, Apostolos Kamekis<sup>3</sup>, Georgia Dimari<sup>4</sup> and Emmanouil Mavrozacharakis<sup>5</sup>*

### Abstract

After 2015, the refugee crisis in Greece became one of the main challenges for policymakers both in terms of immediate measures in order to protect refugees at "hot spots" as well as of their prospects, interventions, actions and policies for their effective integration into the socio-economic system. This research analyses these perspectives and illustrates the difficulties faced by refugees, which prevent them from a rapid integration process as well as the necessary interventions in order to address these issues. Therefore, a triangular research strategy, including both qualitative and quantitative methods, was carried out in order to investigate the difficulties that refugees encounter, the dimensions of their human and social capital as well as the prospects, attitudes, shortcomings and barriers of the labor market which affect their socio-economic integration. The field research was conducted in Crete and Lesbos islands in Greece. The selection of these two geographical areas was based on the different dimensions and potential opportunities for integration as long as the former has received huge refugee flows while the latter has not yet received refugee flows and can be considered as an appropriate field for entrepreneurship-business development and consequently, as an area which could potentially foster refugees' integration in the production process. Thus, the main objective of this research was to record and categorize aspects of the prospects and barriers to refugees' integration into the Greek socio-economic system by examining two diverse but representative rural and insular regions in terms both of integration problems and prospects. The research outcomes are expected to contribute to the construction of intervention directions, which will enhance refugees' social inclusion and development of their human and social capital.

**Keywords:** refugees, immigration, social integration, social inclusion, human capital

### Background

The quest for better living conditions in economically, politically and socially developed and stable countries is a fundamental motivation for immigration and hence for illegal immigration (Gheasi & Nijkamp, 2017). In this context and according to the UNHCR (2018a), more than 1 million refugees and migrants sought entry into the European Union in 2015 and more than 90% came from the top ten refugee production countries.

Greece was the main point of entry and transit for people crossing the Mediterranean Sea during the same period (Archick, 2016). Most people who arrived in Greece in 2015 managed to leave the country in the first months of 2016 (Papageorgiou, 2017). The final closure of the border between Greece and North Macedonia

<sup>1</sup> Professor and Director of the Centre for Human Rights (KEADIK), Department of Political Science, University of Crete, Greece, Email:

<sup>2</sup> PhD, Teaching Fellow, postdoctoral researcher & researcher of the Centre for Human Rights (KEADIK), Department of Political Science, University of Crete, Greece, Email: sttvaz@yahoo.gr

<sup>3</sup> PhD, Researcher of the Centre for Human Rights (KEADIK), Department of Political Science, University of Crete, Greece, Email:

<sup>4</sup> PhD Candidate, researcher of the Centre for Human Rights (KEADIK), Department of Political Science, University of Crete, Greece, Email:

<sup>5</sup> PhD Candidate, researcher of the Centre for Human Rights (KEADIK), Department of Political Science, University of Crete, Greece, Email:

in March 2016 resulted in a situation that 46,000 refugees and immigrants being trapped in Greece (International Amnesty, 2016). In particular, between January 2015 and May 5, 2018, 1,080,656 refugees entered the Greek territory (Fragouliotis, 2018). According to the UNHCR in May 2018, the number of refugees and migrants in Greece amounted to over 60,000, including about 14,000 in the islands (UNHCR, 2018a; 2018b).

Demiri (2015) asserts that some of the difficulties associated with admission to the host country are linked with the fact that asylum seekers and refugees leave their countries by force and therefore constitute a vulnerable group of migrants, often with serious health needs, as they suffer from psychosocial and post-traumatic disorders or other forms of disabilities, health issues and difficulties in adapting to the new social environment.

So is the case for Greece as according to official reports, the situation of refugees is considered critical especially in the reception centers in Lesbos, Samos and Chios. These centers crowd more than 10,000 people in confined spaces (UNHCR, 2018c). According to available data, there are currently five hotspots in Greece (in the islands of Chios, Kos, Leros, Lesbos and Samos), with a total capacity of 6,338 seats. However, the total number of immigrants on the Greek islands (16,500) indicates a serious overcrowding (European Parliament, 2018).

It therefore becomes clear, that although immigrants may experience significant positive effects from their movement, they also face significant risks. Many are suffering from harsh living conditions, are deprived of services and medical care, and are experiencing deteriorating mental health due to their inability to leave confinement in small islands that are not properly equipped to provide the care and services they need (Leghtas, 2017). These problems make it even more difficult to build on their human capital and create new networks which will gradually enforce their human capital and enhance the possibilities for their social integration.

Therefore, it is necessary to ensure adequate support and measures aiming at the socio-economic integration of refugees into the labor market, while preventing any form of competition between the most disadvantaged groups of the Greek society receiving similar social support. The reasons are manifold: first, the evidence suggests that a healthy labor market in the country of arrival is a key factor for successful and permanent integration of refugees (Eurofound, 2016; Fratzscher & Junker, 2015), meaning, in other words, that the inability to integrate refugees into the productive system of Greece could potentially create a number of issues of economic, social and political nature, such as high rates of long-term unemployment and underemployment, and the inability to link qualifications to employment, disruption of social cohesion or even extreme political decisions (Ratha et al, 2011).

Second, in the area of employment, a number of surveys document some of the benefits migrants bring to the indigenous population in most EU host countries. One of such benefits is that immigrant population has a similar age structure, which is more youthful than that of the natives. In addition, young people aged 20 to 49 belong to the productive population and thus are more proportionate among immigrants than among indigenous

people. Moreover in the same age group the proportion of employed versus non-employed is higher among immigrants. Last, but not least, migration increases the growth rate of the workforce (Bagavos & Papadopoulou, 2006).

As Finotelli & Ponzio (2018) point out, a comprehensive integration approach to tackle the migration issue, could bear a series of positive results in the host country's GDP but also on public finances, due to the fact that working refugees are a source of raising tax revenues and contributions, especially for a pension system that could be facing significant shortcomings in economic viability terms, such as the Greek. In other words, the average age of migrants and their high labor market participation have the tendency to contribute positively in the welfare systems of the host countries.

Yet, despite the above-mentioned, a thorough review in the international literature shows that these issues have not been explored in depth, especially in the case of Greece. There are scarce reports regarding a number of legal policies and an amount of statistical data interpretations that in any case cannot yield sufficient research outcomes. Among them, qualitative surveys along with case studies are limited, constituting the need for further research a priority.

In this context, one especially significant aspect of the above-mentioned parameter is to produce and interpret accurate statistics revolving around the number of refugees absorbed by the labor market of Greece, with an emphasis in the low-paid sector, which is of a special concern, as long as according to Zografakis & Kasimis (2014), immigrants in Greece usually work as unskilled, uninsured and are under-paid in areas such as construction, small and medium-sized businesses (clothing), home maintenance and repair, agriculture, elderly and child care, domestic help, tourism, restaurants and outdoor retailer trade.

In the case of Greece, a significant obstacle for the integration of refugees in the labor market, is the fact that they do not speak the Greek language. In addition, they lack professional qualifications despite the fact that according to estimates the majority of refugees are at working age (Deutsche Welle, 2016).

Even though there are some findings on the involvement of refugees in the Greek society on issues such as provision of services, participation in programs, access in the health system, housing, socio socio-cultural exclusion, education and training as well as some scarce findings regarding their health status prior to their arrival in Greece (Kousoulis et al, 2016), yet, only assumptions can be made concerning their living conditions and the factors that impact their effective improvement. The economic integration of refugees in Greece in the period 2015-2018 is thus a particularly interesting area for research. Despite that, little is known about the refugees' prospects for integration in the Greek labor market.

According to OECD (2016), labor immigration in Greece during the economic crisis declined dramatically. Yet, the crisis had a profound impact on the integration of refugees in the labor market. Specifically, their unemployment rate increased by 26 percentage points between 2008 and 2015 (to 33%), compared with an increase of 17 percentage points for Greek people the same period. Indeed, according to OECD (2016) the

unemployment rate of immigrants in Greece is the highest in the OECD area. As far as young immigrants are concerned, data from Eurostat (2017) show that Greece recorded the highest unemployment rates (38.7%) in 2015, following Spain (42.0%). Hence, in Greece, the employment rate of young immigrants was higher than that of young people born in other EU countries for the same period.

Matsaganis (2015) has focused on the negative impact the economic crisis had on the integration of migrants into the Greek labor market. Similar studies address the way individual characteristics of refugees (origin, qualifications and gender) influence their integration process in the labor market of host countries during periods of economic crisis (Andrejuck 2017; Dubucs et al., 2017; Duru & Trenz 2017; Duru et al., 2017; Lulle & Jurkane-Holbein 2017; Marchetti 2017), whereas Triandafyllidou (2016) explored the socio-economic status and the precarious living conditions of immigrants that reside and work in Europe. In a further step, Trenz and Triandafyllidou (2017) assert that the economic crisis in Greece led to a diversification of migratory arrivals in conjunction with an alteration of integration strategies. According to the authors, the economic crisis in Greece had contributed to the augmentation of the significance of economic inequality against that of cultural diversity. According to Cheliotis (2017), the control of illegal immigration in Greece as well as integration policies have been shaped by sovereign political interests in Greece serving workforce needs. Cheliotis (2017) also stresses out that the integration of migrants in the Greek labor market has been shaped by three distinct characteristics, namely a) vast supply of migrants in the Greek case, b) the limited access to social welfare benefits and c) the racial discrimination. Additionally, another interesting study deals with female gender immigrants employed in the Greek household and care sector in the period 2013-2014. The results of the study show that Greek labor market is highly fragmented, thus worsening the general situation of foreign workers during the economic crisis (Maroukis, 2017).

According to OECD (2018), the integration prospects of migrants and the difficulty to implement policies that facilitate their improvement, have worsened due to the economic crisis, which has created huge unemployment rates and poor work conditions. What is interesting though, is that labor market integration is even more difficult in Athens than in other EU cities, as there are limited mechanisms to facilitate the entry of refugees into the market such as skills and validation mechanisms.

Thus, the challenge for Greece, is to look for optimal solutions for the smooth integration of refugees into the Greek socio-economic system. The short-term effects of this phenomenon are often sought and highlighted without focusing on the long-term potential, inherent in this precarious situation and consequently, exploring the factors for drawing up a strategy that will work positively at both social and economic levels becomes a difficult task. It turns out that a weakened economy cannot maximize access to the social rights of its citizens, such as the right to the labor market, but still, it is imperative to work towards this direction, as the integration of migrants in the Greek productive system, could only be for the benefit of the Greek economy, migrants themselves and for the sustainability of the welfare state.



Therefore, policies and investments aimed at creating quality jobs and economic growth should continue to be a priority in Greece. In this context, a successful integration strategy for refugees in economic and social terms is the mechanism that will allow them to achieve important conditions of social prosperity for themselves and for society and the economy as a whole. Exploring the social and human capital of refugees and the factors related to production system's actors that make or facilitate the integration of refugees is the main method for drawing up a framework for interventions with mutually beneficial social inclusion conditions.

## Methods

This research project has followed a methodological strategy that is based on quantitative and qualitative research principles. Mixed methods constitutes a research tool that the outcomes of each one of its instruments reinforces the findings of the other in use (Creswell & Clark, 2017). Thus, for the purposes of this research three (3) different data collection techniques were used. Firstly, a structured questionnaire was distributed in 102 refugees in Lesvos. The questionnaire was divided in five (5) parts (personal information, educational level – skills, employment and integration prospects, health issues and concluding remarks) and included fifty one (51) questions, using inter alia, the Likert Scale. The questionnaires were also translated into Arabic and Farsi for greater ease in comprehension. The second instrument in use was a semi-structured interview in a sample of 150 business executives (entrepreneurs), interest groups and social partners in Lesvos and Crete (75 interviews in each island). The semi-structured interviews were also divided in five (5) parts (introductory part, personal information, entrepreneurship issues, migration issues and concluding part). Lastly, 40 narrative interviews were conducted in Crete with selected “old” immigrants and refugees who have been integrated into the socioeconomic system, in order to identify the prospects, barriers and challenges that they have faced or currently face (the outcomes of this part of the research are not presented in this article). The quantitative research was conducted from September 30 to October 10, 2018 and the semi-structured interviews in Mytilene from September 30 to October, 10, 2018 and in Crete from October 15 to December 30, 2018.

In addition, this research used the principles of Grounded Theory, which constitutes a methodological tool that aims at the production of theory concerning the object that is under investigation (Robson, 2016). In other words, it is a theory based on empirical data which are collected and analyzed in a systematic manner.

The research process focused on two (2) different selected areas so as to identify the distinction in the distribution of needs and to include the geographic factor into the design of the intervention proposals. The geographical areas include the island of Crete, which has not received waves of refugees but is an active field of entrepreneurship, and the island of Lesvos, which has received the largest number of refugees and faces immense socio-economic problems as well as challenges.

The rationale behind the choice of these specific research methods is that it makes it possible to highlight the perspectives for the integration of refugees into different socio-economic environments, which can, in turn, provide a guide as far as their integration at national level is concerned. In this way, it is possible to create a first categorization, in terms of incentives, problems and challenges in social and economic contexts in order

to form empirically grounded policy proposals and thus, achieve long-term economic and social benefits (Suddaby, 2006).

### **Selected descriptive data of the quantitative research on refugees in Lesvos**

#### ***Demographic characteristics and reasons of migration***

The quantitative research included 102 structured questionnaires to refugees in Lesvos, Greece during the period September 30 - October 10, 2018. It turns out that 55.1% of the participants was male and 44.9% female while the vast majority of the respondents ranged from 18 to 35 years old, illuminating that this large portion of young population which has migrated mainly from the Middle Eastern countries is clearly a potential workforce for which drastic measures should be taken in order to be smoothly integrated into the host countries. Interestingly, 51.1% of the participants have children. Indeed, 59% of them currently live together with their parents in Greece and hence they should be properly treated and protected while, at the same time, they should be integrated into the Greek education system. Additionally, the majority of the respondents indicate that they are in Greece for approximately up to one year. This finding is crucial taking into consideration that asylum should be granted to them and they should also join both education as well as employment.

**Table 1: Demographic data of the respondents-refugees**

<i>Gender and Children</i>	<i>Men</i>	<i>Women</i>	<i>With Children</i>		<i>Without Children</i>	
	<b>55.1%</b>	<b>44.9%</b>	<b>51.1%</b>		<b>48.9%</b>	
<i>Age</i>	<i>18-25</i>	<i>26-35</i>	<i>36-45</i>	<i>46-55</i>	<i>56-65</i>	<i>65+</i>
	<b>42.9%</b>	<b>33.0%</b>	<b>12.1%</b>	<b>6.6%</b>	<b>4.4%</b>	<b>1.0%</b>
<i>Family Residence</i>	<i>Greece</i>	<i>Other European Country</i>		<i>Home Country</i>	<i>Country Outside Europe</i>	
	<b>59.0%</b>	<b>8.4%</b>		<b>18.1%</b>	<b>14.5%</b>	
<i>Duration of Residence in Greece</i>	<i>More than 3 years</i>	<i>3 years</i>	<i>2 years</i>	<i>1 year</i>	<i>7-11 months</i>	<i>0-6 months</i>
	<b>2.2%</b>	<b>1.1%</b>	<b>16.3%</b>	<b>43.5%</b>	<b>23.9%</b>	<b>13.0%</b>

A particularly interesting finding is connected with the indicators that are linked to the causes that led migrants to flee their countries of origin. Interestingly, the respondents' answers vary significantly as long as a large number of participants refer to the individual factors as either "extremely important" or "not at all important" (Figure 1). Yet, it turns out that wars and clashes are the primary reasons of migration for the vast majority of respondents. However, it should be stressed that the diversion in all the other variables, such as political reasons, education, social security, income, unemployment and further economic reasons, reveals two more crucial findings (Figure 1). Firstly, that war has had similar repercussions on different socio-economic groups, and secondly, that an important number of refugees were facing socio-economic problems prior to their migration.

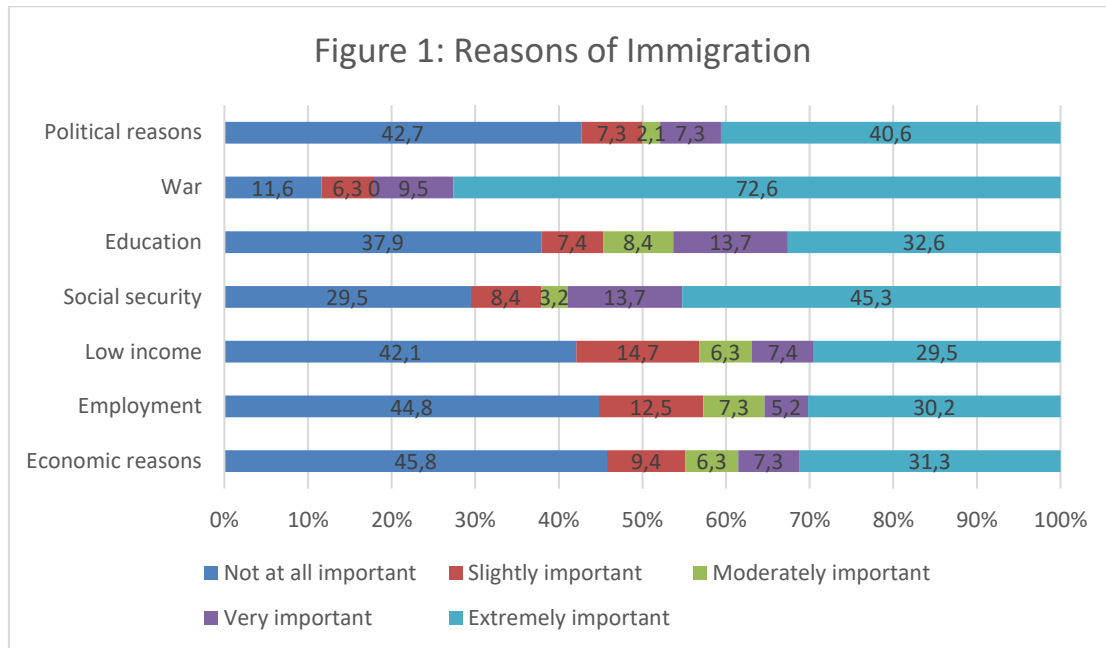

***Educational background and skills***

The level of education of the respondents seems rather low for the majority, stressing out the need for public policy interventions in order to improve it and offer to them the required skills that will facilitate their integration. Approximately 17% of the participants mention that they have not been subjected to school education at all, whereas 34.6% of the sample has only completed primary education. About 22.1% has finished High School, 23.5% Lyceum and merely a percentage of 2.5% indicate that has finished a Vocational School. In tertiary education, only 14% of those who have secondary education hold a university degree. Another interesting finding is that merely 15.6% of the respondents is currently receiving school education in Greece.

Evaluating refugees’ skills is important in order to acquire a clear view of their human capital. This assessment is inextricably linked to the identification of existing prospects for their integration as well as the capacity for skills’ improvement in order to facilitate inclusion. In terms of IT skills, (Figure 2), approximately 20% of the participants mention having either good or very good knowledge, whereas the 80% states that its cognitive level is inadequate. About 1/3 of the respondents indicate no skills concerning the use of electronic computer (IT). The outcomes for the knowledge of foreign languages (Figure 2) suggest that the majority of the respondents speaks English insufficiently whereas approximately half of them state a very poor knowledge of the Greek language. Additionally, 51% of the respondents indicate that it does not speak at all the Greek language. This finding stresses out the importance of the language issue that inevitably affects the refugees’ smooth integration. Regarding other languages, a very low percentage speaks either French or German.

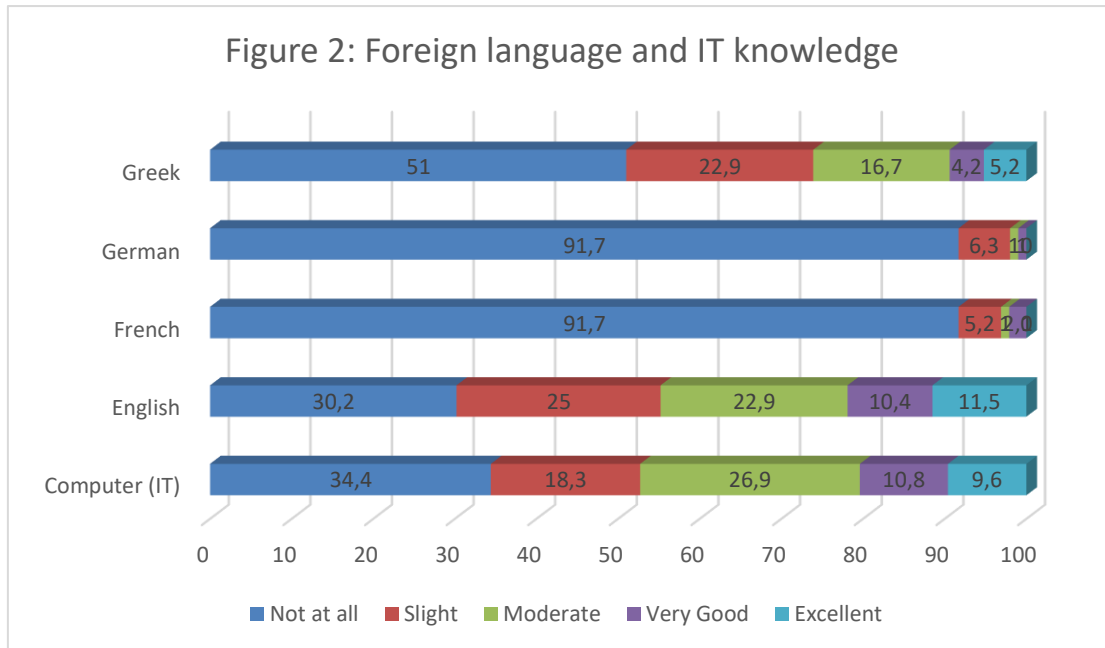

It turns out that only 20% of the respondents indicate participation in training programs according to expertise, which was funded either by the state or by the company in which they used to work in their country of origin. Consequently, the overwhelming majority of them desire and expect to join education programs. In fact, due to their low educational level, their main focus is either primary or secondary school education.

### ***Employment issues***

A crucial aspect for the integration of immigrants is the knowledge of the labor market of the host country as well as ways to participate in it. Thus, an assessment of refugees' knowledge regarding the labor market of Greece, concerning seeking job skills and the evaluation of their work experience in their country of origin - and in Greece - is significant. Therefore, it stems out that the majority of the respondents (75.6%) mention that they have not any kind of knowledge concerning the current situation of the Greek labor market. Additionally, a low percentage (10.4%) states that it is working at the moment but in low income jobs (up to 300 €).

However, despite the fact that refugees have low income jobs, yet they report that they are either too much or quite satisfied from their jobs (Figure 3). Nevertheless, this could be attributed to the extremely difficult situation that they have encountered during their migratory transitions and their hosting conditions in Greece. What is for sure, though, is that counseling, especially for job seeking and employment opportunities, is necessary due to the fact that almost all refugees indicate that they are not aware of any ways to seek job in the Greek territory (Figure 3). Moreover, 87.1% of the participants state that they would like to reside and find a job in Greece, especially in the secondary (49.3%) or tertiary (45.3%) sectors.

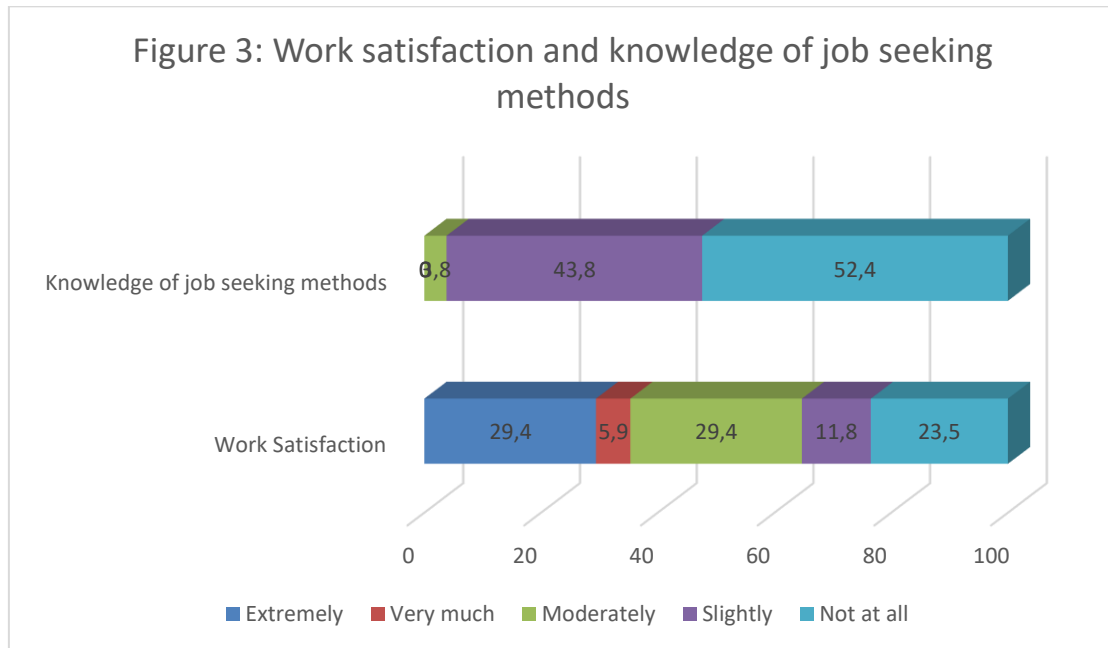

### *Health issues*

The right to health is a moral principle and determines the living conditions. Therefore, the improvement of refugees' health is crucial for their smooth and effective integration into Greek society and economy. The findings of our research show that the health status in the majority of respondents has been improved after their arrival in Greece. About 80% of the respondents states that it has encountered either a psychological or physical trauma during its migratory route. What is particularly worrying, though, is that 32% of the respondents indicate that their health is still in a poor or very poor condition. Therefore, it is necessary authorities to tackle this situation immediately. Regarding the refugees' satisfaction with health services offered in Greece, the general respond trend is 'moderate'. Specifically, for about one-third (1/3) of the respondents the lack of knowledge of the Greek language seems to be a major impediment regarding communication with healthcare professionals and this obstacle could lead to insufficient treatment of their health problems.

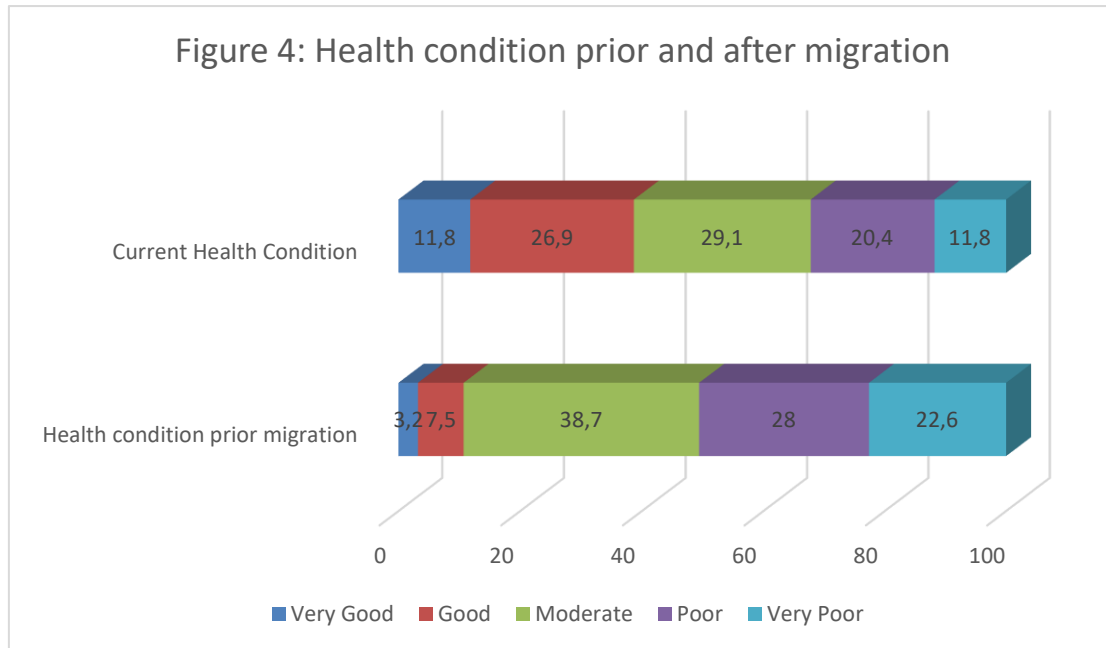

### Indicative outcomes from the qualitative research with entrepreneurs in Lesvos and Crete

Qualitative research included the analysis of 150 semi-structured interviews in Crete and Lesvos with entrepreneurs, that is, 75 in each island. Specifically, in the island of Lesvos there is a diverse trend in the opinions towards refugees, with a portion of participants being immensely positive in integrating them in the labor market. On the contrary, a significant number of entrepreneurs have a negative stance towards the integration of refugees. Specifically while a respondent point out that *“especially in my job we rely on the workforce of people who come from abroad”*, a totally diverse opinion is expressed by another, *“I am totally negative, as long as there is a high unemployment rate among Greeks”*. This example is indicative of the diversification of entrepreneurs’ opinions especially in Lesvos, where most responses are totally diverse to each other.

Furthermore, from the analysis of the semi-structured interviews it becomes apparent that the integration options in Lesvos are limited in comparison to Crete. Among the difficulties mentioned, in both geographical regions, the lack of Greek language knowledge, the precarious state of refugees’ residence, the difficulties in recognition of skills and diplomas obtained in the refugees’ country of origin, as well as the lack of counseling support for labor market integration and the long unemployment periods, are the most important obstacles for their integration into the labor market.

According to the entrepreneurs in Crete and much less in Lesvos, there is a high integration rate in the agricultural and tourist sectors and especially in areas of “heavy” work, such as construction. Furthermore, entrepreneurs confirmed that the majority of the refugees do not have special professional qualifications. However, they are at a working age group and therefore it is important to enhance their productive capacity, through the development of targeted educational and training actions.

The semi-structured interviews have confirmed the hypothesis of the project about the existence of the relatively low rate of employment of refugees, particularly in low-paid, unskilled labor sectors. Thus, entrepreneurs point out the necessity of education and training for the refugees in order to be able to employ them. Indicatively and in line with the above-mentioned some respondents indicate: *“I think that integration process should be focused on education”, “Firstly they should attend Greek language courses”*. Some stress out the necessity for legal documentation which is a barrier for their smooth integration into the labor market: *“Refugees and immigrants should have legal documents in order to be integrated, either wise they will work in black economy and they will not have good chances to be integrated”*.

Obviously, in important economic sectors such as tourism, agriculture and construction, particularly in Crete, there are adequate conditions for the economic integration of refugees, a process that will benefit both refugees and the local economy. In this sense, in the example of Crete, it is quite clear that refugee integration can offer visible opportunities for the economy and thus, it should be further fostered with targeted interventions, such as the allocation of refugees based on a needs assessment of the local labor market opportunities.

## Discussion

The main findings of the research indicate the necessity for the design and implementation of policies which should aim both at the protection of their immediate problems (health issues, protection of unaccompanied minors etc.) and improvement of their living conditions as well as at their socio-economic integration into the labor market, but without generating negative effects amongst the most vulnerable groups in the Greek society. Thus, integration strategies should focus on the creation of quality jobs and economic growth, in conjunction to the empowerment of welfare or other social support measures for vulnerable groups.

Another element that complicates the development of effective measures of social inclusion and integration into the labor market is related to their often unpopular character for some citizens. The main factor is xenophobia, which has risen the last years due to the economic crisis of Greece. Xenophobia was expressed by indigenous people (several of the entrepreneurs interviewed especially in Lesbos) and is perceived as a threat from the arrival of a significant (or even a small) number of asylum seekers and refugees. Several entrepreneurs-respondents of the semi-structured interviews seem to believe that the existence of refugees can increase competition in access to services or employment, especially when and where unemployment is high and social conditions particularly harsh.

Nevertheless, refugees do not generally constitute a threat, since the majority of them are low-skilled with low levels of working experience and insufficient knowledge of the Greek language or IT skills. It is obvious that this deficit in skills leads to their classification as unskilled workforce. Thus, they seem to have some crucial opportunities to work in regions such as Crete, where there is need for labor force and especially in sectors such as construction or agriculture. Therefore, there is urgency for targeted actions in terms of counseling and support both for employment, education and training.

## Concluding remarks

It turns out that refugees in Greece encounter several integration problems due to inefficient interventions in terms of counseling, education and training. Moreover, xenophobia is an apparent characteristic especially where there are increased numbers of refugees, such as in Lesbos. Therefore, the design of a mechanism that will enable the conditions for the social well-being of refugees as well as for the society and economy should be part of a strategic planning that will aim at a successful process of refugees' integration in economic and social terms with a geographical perspective, taking into account the needs of every region, which are totally different as it was shown in the comparison between Crete and Lesbos. It turns out that the conditions for integration process of the refugees into the Greek socio-economic system exist, especially in specific sectors of the economy and also in specific areas, such as Crete, but education, training, counseling support for job seeking and especially language learning are primary issues of policy intervention. In order to achieve the opportunities for socio-economic integration of refugees, though, it is necessary to investigate more and assess both their social and human capital and reveal their needs as well as the needs of the local labor markets in Greece, in order to enable empirically grounded policy proposals and interventions.

## Acknowledgements

The research project "Detection and classification of perspectives for the inclusion of refugees in the Greek production system. Case study in Crete and Mytilene" is implemented through the Operational Program "Human Resources Development, Education and Lifelong Learning" and is co-financed by the European Union (European Social Fund) and Greek national funds.

We would like to show our gratitude to Iliaktida AMKE and especially to Dr. Vasiliki Andreadelli-President, Mr. Antonis Zeimpekis-Head Welfare Officer/Field Coordinator, Ms. Konstantina Kalampoki-Families Welfare Coordinator and Mrs. Vasiliki Panagitsa-Social Worker, for their assistance in the conduction of the quantitative research to refugees in Mytilene and for sharing their pearls of wisdom with us during the course of this research.

## References

- Andrejuk, K. (2017). Self-employed migrants from EU Member States in Poland: differentiated professional trajectories and explanations of entrepreneurial success. *Journal of Ethnic and Migration Studies*, 43(4): 560-577.
- Archick, K. (2016). The European Union: current challenges and future prospects. *Congressional Research Service*, 21.
- Bagavos, C., & Papadopoulou, D. (2006). Immigration and integration of immigrants in Greek society. *Scientific Society for Social Policy*. Gutenberg.
- Cheliotis, L. K. (2017). Punitive inclusion: The political economy of irregular migration in the margins of Europe. *European Journal of Criminology*, 14(1): 78-99.
- Creswell, J. W., & Clark, V. L. P. (2017). *Designing and conducting mixed methods research*. Sage publications.
- Demiri, N. (2015). The Refugee Crisis in Greece. Available at: <https://gr.boell.org/el/2015/11/17/i-prosfygiki-krisi-stin-ellada> [Access 1/8/2019] (in Greek).



- Deutsche Welle (2016). The difficult labor integration of refugees, Available at: <http://www.dw.com/el/%CE%B7-%CE%B4%CF%8D%CF%83%CE%BA%CE%BF%CE%BB%CE%B7-%CE%B5%CF%81%CE%B3%CE%B1%CF%83%CE%B9%CE%B1%CE%BA%CE%AE-%CE%AD%CE%BD%CF%84%CE%B1%CE%BE%CE%B7-%CF%84%CF%89%CE%BD-%CF%80%CF%81%CE%BF%CF%83%CF%86%CF%8D%CE%B3%CF%89%CE%BD/a-19230154> [Access 1/8/2019] (in Greek).
- Dubucs, H., Pfirsch, T., Recchi, E., & Schmoll, C. (2017). Je suis un Italien de Paris: Italian migrants' incorporation in a European capital city. *Journal of Ethnic and Migration Studies*, 43(4): 578-595.
- Duru, D. N., Hanquinet, L., & Cesur, N. S. (2017). Perceptions of diversity and attitudes of tolerance in the 'fragmented' UK. *Journal of Ethnic and Migration Studies*, 43(4), 674-692.
- Duru, D. N., & Trenz, H. J. (2017). From diversity to conviviality: intra-EU mobility and international migration to Denmark in times of economic recession. *Journal of Ethnic and Migration Studies*, 43(4): 613-632.
- European Parliament (2018). Hotspots at EU external borders State of play. Briefing. *EPRS | European Parliamentary Research Service*. Available at: [http://www.europarl.europa.eu/RegData/etudes/BRIE/2018/623563/EPRS\\_BRI\(2018\)623563\\_EN.pdf](http://www.europarl.europa.eu/RegData/etudes/BRIE/2018/623563/EPRS_BRI(2018)623563_EN.pdf) [Access 10/9/2018].
- Eurostat (2017). Migrant integration: 2017 edition. *Eurostat Statistical Books*. ISBN 978-92-79-74148-7 doi: 10.2785/295423. Available at: <https://ec.europa.eu/eurostat/documents/3217494/8787947/KS-05-17-100-EN-N.pdf/f6c45af2-6c4f-4ca0-b547-d25e6ef9c359>. [Access 1/8/2019].
- Finotelli, C., & Ponzo, I. (2018). Integration in times of economic decline. Migrant inclusion in Southern European societies: trends and theoretical implications. *Journal of Ethnic and Migration Studies*, 44(14): 2303-2319.
- Fragouliotis, D. (2018). The Refugee Crisis in Greece and the World: The Numbers that Shock. *CNN Greece.gr*. Available at: <https://www.cnn.gr/news/kosmos/story/129913/to-prosfygiko-stin-ellada-kai-ton-kosmo-ta-noymera-poy-sokaroyn> [Access 22/6/2019] (in Greek).
- Fratzscher, M., & Junker, S. (2015). Integrating refugees: A long-term, worthwhile investment. *DIW Economic Bulletin*, 5(45/46): 612-616.
- Gheasi, M., & Nijkamp, P. (2017). A brief overview of international migration motives and impacts, with specific reference to FDI. *Economies*, 5(3): 31.
- International Amnesty (2016). *Trapped In Greece: An Avoidable Refugee Crisis*. EUR 25/3778/2016. Available at: <http://www.refworld.org/docid/571db6df4.html> [Access 28/8/2018].
- Kousoulis, A. A., Ioakeim-Ioannidou, M., & Economopoulos, K. P. (2016). Access to health for refugees in Greece: lessons in inequalities. *International journal for equity in health*, 15(1): 122.
- Leghtas, I. (2017). Like a Prison: Asylum Seekers Confined to the Greek Islands. Refugees International. Field Report. August 2017. Available at: [https://static1.squarespace.com/static/506c8ea1e4b01d9450dd53f5/t/59920f919f74567e875ab5cc/1502744473695/201708+Greece\\_PDF\\_DRAFT+TWO.pdf](https://static1.squarespace.com/static/506c8ea1e4b01d9450dd53f5/t/59920f919f74567e875ab5cc/1502744473695/201708+Greece_PDF_DRAFT+TWO.pdf) [Access 2/7/2019].
- Lulle, A., & Jurkane-Hobein, I. (2017). Strangers within? Russian-speakers' migration from Latvia to London: a study in power geometry and intersectionality. *Journal of Ethnic and Migration Studies*, 43(4): 596-612.
- Marchetti, S. (2017). Networks beyond nationalities? Relationships amongst Eastern European women workers in Italy facing the economic crisis. *Journal of Ethnic and Migration Studies*, 43(4): 633-651.
- Maroukis, T. (2017). Migrant care workers' trajectories in a familistic welfare regime: labour market incorporation and the Greek economic crisis reality-check. *Journal of Ethnic and Migration Studies*, 1-17.
- Matsaganis, M. (2015). Youth unemployment and the Great Recession in Greece. *No Country for Young People?*, 77., edited by Juan J. Dolado, 77-87. London: CERP Press.
- OECD (2016). Greece Policy Brief. *OECD Better Policies Series*. Available at: <https://www.oecd.org/policy-briefs/greece-addressing-migration-challenges-beyond-the-current-humanitarian-crisis.pdf> [Access 6/9/2018].
- OECD (2018). Working Together for Local Integration of Migrants and Refugees in Athens, OECD Publishing, Paris. Available at: <https://doi.org/10.1787/9789264304116-en> [Access 1/8/2019].
- Papageorgiou, I. (2017). International protection in Greece: Background information for the LIBE Committee delegation to Greece 22-25 May 2017. Directorate General for Internal Policies, Policy Department C: Citizens' Rights and Constitutional Affairs, Civil Liberties, Justice and Home Affairs.
- Ratha, D., Mohapatra, S., & Scheja, E. (2011). *Impact of migration on economic and social development: A review of evidence and emerging issues*. The World Bank.
- Robson, (2016). *Real World Research*, New York: John Wiley & Sons Inc.
- Suddaby, R. (2006). "From the Editors: What Grounded Theory is Not". *Academy of Management Journal* 49 (4): 633-642.

- Trenz, H. J. & Triandafyllidou, A. (2017). Complex and dynamic integration processes in Europe: intra EU mobility and international migration in times of recession. *Journal of Ethnic and Migration Studies*, 43(4): 546-559.
- UNHCR (2018a). High Commissioner for Refugees, Refugees / Emergency Migrants in the United Kingdom. Available at: <http://data.unhcr.org/mediterranean/regional.php>. [Access 20/6/2019] (in Greek).
- UNHCR (2018b). Greece. Factsheet. July 1-31. Available at: <http://www.unhcr.org/gr/> [Access 7/9/2018].
- UNHCR (2018c). 'UNHCR urges Greece to address overcrowded reception centres on Aegean islands.' Available at: <https://www.unhcr.org/news/briefing/2018/8/5b88f5c34/unhcr-urges-greece-address-overcrowded-reception-centres-aegean-islands.html> [Access 1/7/2019].
- Zografakis, S. & Kassimis, C. (2014). Greek economy and immigrants: Yesterday ... today ... tomorrow. Hellenic Union of Banks. In Masourakis, M., & Gortsos, X. (eds.), *Competitiveness for Development: Policy Proposals*. Athens: Hellenic Union of Ban

## 6.6. The Changing Face of the Common European Asylum System: The Uncertain Future and Challenges for Refugees' Integration in the European Union

*Sibusisiwe Bulala Kelly<sup>1</sup>*

### Abstract

Integration of immigrants has been the top priority for the European Union (EU) since 1990s the Common European Asylum System (CEAS) was proposed in 1999 and adopted in 2004. However, in the specific case of refugees' integration there is no explicit EU policy and their integration is based on the Qualification Directive 2011. Following the migration pressure in 2015 that resulted in poor response from the EU it was clear that the need for consistent and clear policies was imperative. This paper draws from the continuing comparative theoretical investigation carried out between Greece and Ireland, on the challenges of integrating refugees as guided by the CEAS. Acknowledging that not all asylum seekers become refugees the question is, at what stage should integration process start? The theoretical reflections will focus on difficulties in accessing asylum and integration complexities in areas of employment, formal education, health and social care. Also recognising that, CEAS was created to harmonise the asylum system among EU Member States in order to prevent asylum seekers reaching countries with attractive asylum and integration systems. However, findings based on literature review have shown that due to deficiencies of Dublin regulation and EU Turkey Statement some EU Member States have taken an opportunity to exploit the weaknesses of these policies. The consequences of these policies have facilitated the shift from curtailing asylum seekers searching for favourable asylum system within the EU to the promotion of a strategy that allows EU Member States to choose asylum seekers deemed with most attractive characteristics and skills that suit the host country. Not only is this move considered morally wrong by advocates of refugee integration schemes but it is also violating the international law of refugees' protection and undermining already compromised CEAS that have greater potential of causing severe damage to the EU values and reputation. Thus, lack of political will, solidarity and unfair share of responsibilities endures among EU Member States. Equally, the fates of asylum seekers continue to plunge into continuous state of limbo/immobility with no clear direction and hope for their future. Managed effectively, the integration of refugees could be vital to the future well-being, prosperity and strength of EU societies.

**Keywords:** Refugees, Asylum-seekers, Integration, Complexities, Common European Asylum System.

### Defining Terms and Concepts

It should be acknowledged that among academics there is no consensus on the definition of the integration of immigrants let alone the definition of refugees' integration. The United Nations Department of Economic and Social Affairs defines refugees' integration as a complex and multidimensional concept, consisting of integration into the economic, health, educational and social context, (Robila, 2018). This definition is considered appropriate for this paper as it is in line with the integration approach of the EU. European Asylum Support Office (ESAO, 2016) established to improve practical cooperation on asylum matters and helping Member States fulfil their European and international obligations to give protection to people in need of it (CEAS, 2019). An Asylum seeker is defined as someone whose international protection claim has not yet been finally decided on by the country in which he or she has submitted it. Equally, acknowledging that not every

---

<sup>1</sup> PhD Candidate European Law and Governance School (ELGS) Greece. Email: Sibusisiwe.kelly@elgs.eu

asylum seeker will eventually be recognised as a refugee, nonetheless every refugee is initially considered an asylum seeker (Amnesty, 2019). It is worth noting that the Geneva Convention does not specify the rights of an asylum seeker however, their rights are protected under the International Human Rights Laws.

It should be noted that when defining a refugee there are contexts that are taken into consideration such as the global (Geneva Refugee Convention, 1951) and the EU context. The EU context defines a refugee as either a third country national who owing to a well-founded fear of persecution for the reasons of race, religion, nationality, political or membership of a particular social group is outside the country of nationality and is unable or owing to such fear, is unwilling to avail themselves of the protection of that country or a stateless person who is being outside of the country of former habitual residence for the same reasons as mentioned above is unable or, owing to such fear, unwilling to return to it, and to whom article 12 exclusion of the Directive 2011/95/EU does not apply (European Commission, 2018a).

It should be noted that the main objective of this Directive 2011 is to ensure that the EU Member States apply common criteria for the identification of persons genuinely in need of international protection, also to ensure that a minimum level of benefits is available for those persons in all Member States. The difference between the global context and EU definition of a refugee is that the global context refers to a refugee as “A PERSON” and the EU applies the term “THIRD COUNTRY NATION plus the incorporation of the Article 12 of the Directive 2011/95/EU requirements.

The European Commission defines an economic migrant as someone who leaves his or her country of origin purely for financial and economic reasons in order to seek material improvement and livelihood (European Commission, 2019a). The Commission acknowledges that it does not have legal obligations to grant asylum to immigrants as they do not flee from persecution but move for better life unlike asylum seekers and refugees.

## **1. Introduction**

As the numbers of refugees and displaced people increase worldwide so does the challenges concerning CEAS and the integration of asylum seekers and refugees within the EU. This paper seeks to assess the EU response to the perceived EU refugee crises in 2015 also to critically evaluate the effectiveness and challenges of the CEAS. In relation to the regulations and policies that govern the EU Asylum System and their impact on the asylum seekers and refugees' integration. It is acknowledged that the term refugee comprise of deferent definitions and categories, such as third nationals, displaced people or people granted temporary or subsidiary protection and so forth. Although this paper may refer to other terms its main focus is on asylum seekers and refugees as defined in the context of the EU in accordance with the 1951 Geneva Refugee Convention. It is also acknowledged that there is literature, theories and policies of integration that do not differentiate between an immigrant, a refugee and an asylum seeker as they tend to use these terms interchangeable despite the distinct legal definition of a refugee.

According to the European Commission at the end of 2018 people who were in need of protection and assistance as a consequence of worldwide forced displacement reached 70.8 million from 65.5 million previous year (IOM 2018). This means 41.3 million of these people were internally displaced, 25, 9 million were recognised refugees and 3.5 million of this population were asylum seekers which means still waiting for their cases to be heard or awaiting for the decisions (UNHCR, 2019a). Germany is among top 5 refugee hosting countries with 1.1 m, equal to Sudan, Uganda 1.2m Pakistan 1.4 and Turkey 3.7m (UNHCR, 2019a). Furthermore, 80% of today's refugees are claimed to be women and children. This indicates that around the world a person is becoming displaced every two seconds (European Commission, 2019a). The EU registered just above 1.3 million applications for international protection in 2015, 1.2 million in 2016, and 712,000 in 2017 and in 2018 the numbers fell to 638, 0000 (numbers rounded off), (Eurostat, 2019).

It is worth noting that the 1992 fact sheet Number 20 for Human rights and Refugees claim that in 1951 when the UN Commission for Refugees was established there were approximately 1000 refugees and most of them were Europeans. Unlike then, the current majority of refugees come from Middle East, Africa and Asia and in unprecedented numbers (UNHCR, 1992).

The United Nations states that due to lack of sustainable peace in many countries of origin, restrictive host country policies and limited resettlement places, most displaced people live in protracted displacement for more than five years (UNHCR, 2004). Also defines a protracted refugee situation as 'one in which refugees find themselves in a long-lasting and rigid state of limbo. For example, the situation of hotspots in Greece and Italy which was designed as an emergence temporary response to the 2015 perceived EU refugee crisis (European Parliament, 2018). Unfortunately, research has shown that the EU Hotspot Approach and Direct Provisions (accommodation centres for asylum seekers in Ireland) has thrown asylum seekers into a persistent state of limbo with their human rights being consistently violated (HRW, 2019; Thomas, 2019). The UNHCR (2004) claims that the lives of protracted refugees may not be at risk however, their basic rights and essential economic, social and psychological needs remain unfulfilled after years in refugee camps. A refugee in this situation is often unable to break free from enforced dependence on external assistance, According to the European Commission currently protracted, displacement for refugees last on average of up to 10 years and 25 years for the internal displaced people due to lack of durable solutions, such as voluntary repatriation, resettlement or local integration (European Commission, 2016).

On the other hand, European Commission reports show that as the number of immigration increased from 2015 so did the fear of terrorism attacks among European citizen and this was a great concern for the EU. Also, the increase in numbers of people seeking asylum meant significant increase in administrative, reception, border controls and financial challenges in several EU countries. Consequently, the urgent change to national and European migration-related policies was imperative though in ad hoc bases that resulted to poor decision making. The EU Specific response was an increase in EU funding for migration-related issues integration of

third nationals and broadening of the scope of EU institutions and agencies in the management of border control and asylum-related issues plus (European Commission, 2018a).

There are two regulations that are explored throughout this paper as they are considered problematic to the effectiveness of the CEAS such as the Dublin Regulation also known as the EU Regulation 604/13 and the March 2016 EU Turkey Statement.

## **2. The Challenges of the Dublin Regulation and the EU Turkey Statement**

### **2.1. Impact of Dublin Regulation**

Dublin regulation is viewed as the cornerstone of the CEAS aimed to provide a clear workable and rapid method for determining the Member State responsible for examination of and application for the international protection of third country national or stateless person (EASO, 2019). However, research shows that the Dublin Regulation was not designed to withstand the perceived EU refugee crisis that occurred in 2015. As the requirement that people should seek asylum in the first country of entry in the EU meant countries such as Greece, Italy and Spain would bear unfair burden of responsibilities. Before proceeding further, it is worth noting that in 2008 the European Commission of Communities Policy Plan on Asylum was developed to promote the integrated CEAS and consistency among Member States based on three characteristics.

**Firstly:** The recognition of disadvantaged EU Member States in relation to receiving and processing the asylum applications mainly due to their geographic locations. For example, according to the Pew Research Centre approximately 2.1 million people have entered EU shores through Greece, Italy and Spain since 2009 to 2018. The Pew Research further claim that among these three countries, Greece has been the most affected country for some years with 1.2 million arrivals since 2009 -2019. These numbers are considered to be more than the other two countries combined for instance in 2015 the number of people who entered Greece accounted to 73% (876,000) mainly from Syria, Iraq and Afghanistan (Connor, 2018). On the other hand, the statistics from the UNHCR Greece claim that in 2015 sea arrivals in Greece were 856,723, in 2016 this number decreased to 173,450, in 2017, 29,718, in 2018, further decrease to 32,494 and in July 2019 there were 17,842 arrivals. The majority of arrivals in 2019 were from Afghanistan 6,045 (34%), Syria 3,403 (19%) and the Democratic Republic of the Congo 2,135 (12%). More than half of the populations were women (25%) and children (36%), while 39% were men (UNHCR, 2019b).

**Secondly:** The harmonisation of the CEAS among Member States was considered necessary due to differences in decisions to recognise or reject asylum requests for applicants from the same countries of origin. However, these incoherencies still persist if not worsening among Member States as it is not unusually for asylum seekers from the same country or same family to be given different decisions on their asylum applications. For example, in 2017 Deutsche Welle (DW) reported that in Greece two brothers among other rejected refugees from the same country went on hunger strike, one brother in solidarity with the other brother whose asylum application was rejected and his approved (Gostoli, 2017). Furthermore DW stated that in most cases asylum

seekers are rejected based on local attitudes, meaning the more xenophobia attacks in a given State the more rejections the asylum seekers get (DW, 2017). Despite the fact that Germany has taken the highest numbers of asylum seekers since the perceived EU refugee crisis. According to the findings of the University of Konstanz asylum applicants are not treated equally in all German federal states during all relevant decision-making stages (Schneider, et al, 2019). Furthermore, the increase of xenophobia discrimination, intolerance and racism in the EU Member States was highlighted by the (World Report, 2019).

**Thirdly:** There were growing concerns in the Union that Member States were increasingly granting the subsidiary protection or other kinds of protection based on national law rather than granting people refugee status according to the Geneva Convention. Judging from this observation, it is clear that the EU recognises that the Geneva Convention definition of a refugee is too narrow to cover today's conflicts and persecutions. That is to say the wars of today are no longer fought the same way they were fifty or seventy years ago and people today are much more informed than there were fifty or seventy years ago. Therefore, it is highly unlikely that countries can invade or drop bombs on other countries and return home to live happily ever after without any consequences of their actions following them back. For example, the chain reaction that started with Afghanistan war in 2001, Iraq 2003, Libya, and Syria these countries were at war three years before the 2015 EU refugee crisis that led to EU Turkey Statement.

## 2.2. The Impact of the 2016 EU-Turkey Statement

According to the legislative reports the EU Turkey Statement agreed in March 2016 Turkey was to do whatever necessary to ensure the business model of smugglers' of irregular immigrants was dismantled (European Parliament, 2019). Theoretical, the EU Turkey Statement was supposed to ease the burden that Greece was facing as a gateway to EU for irregular immigrants and in return Turkey was to get six billion Euros by 2018 and the country's citizens will get to travel visa free within the EU. However, as of July 2019 the Turkish FM reported that due to failure of EU in keeping its side of the bargain the deal has been suspended (TM, 2019). It is very difficult to comprehend what was the EU thinking when it made this Statement with Turkey. To begin with, the free movement of the EU citizens is regarded as the core principle of the European Union, the value that is legally protected under the EU Treaties consolidated in the Directive 2004/38/EU.

Viewing this from the business perspective, for those who understand the principles of outsourcing it is considered a very bad mistake for any organisation/institution to outsource core elements of its business or features that are of strategic importance. Therefore, why would the EU bargain with its core principle with a country that is not bound by the EU values and laws? What will happen if Turkey decides to make true of its threat to open its borders and let the refugees go? Bearing in mind that there are 3.7 recognise refugees in Turkey, however there are also uncounted for irregular/illegal immigrants who are waiting impatiently for the unthinkable to happen. Consequently, it is not unreasonable to ask how prepared is the EU for the end of its precarious agreement with Turkey? On the other hand, the EU has shown solidarity with Greece by rewarding the Country with 2.2 billion for handling the crisis since 2015-2019 (European Parliament, 2019).

Unfortunately, as Greece continues to hold large numbers of asylum seekers, the protection of their rights continue to deteriorate (Human Right Watch, 2019). Despite these claims the EU insist that the continued commitment to implement the EU-Turkey Statement and the major financial and operational support from the EU since 2015 have made a major contribution in alleviating the pressure on the Greek islands (European Commission, 2019a).

On the other hand, the critics believe that the 2016 EU Turkey Statement has compromised the right to seek asylum in the EU through the use of pushback practices. With all things considered it is argued that both Dublin Regulation and EU Turkey Statement have undermined the fundamentals of the CEAS in which the aim was to ensure fair treatment of asylum seekers through an open and fair system among Members States. As well as promoting a fair share of responsibilities and solidarity, meaning fair distribution of EU funds and asylum seekers between Member States.

However, the lack of political will and common understanding within the Union has distorted the lines of solidarity and fairness among Member States as Jean-Claude Juncker stated in 2018: “We cannot continue to squabble to find ad-hoc solutions each time a new ship arrives Temporary solidarity is not good enough. We need lasting solidarity - today and forever more” (European Commission, 2018a).

### **2.3. The EU Solidarity to the Member States**

Recently, the European Commission (2019a) has published a paper “Debunking Immigration Myths” explaining how the Union have shown solidarity to its Member States, not only through extensive funding but also practical support. Such as deployment of personnel and equipment to help manage migration issues, protect the EU external borders particularly, for those Member States most affected. The Commission also emphasised that the EU continue to save lives, give protection to those who “need it” and “effectively return those who do not” (European Commission, 2019b). Nonetheless, it is not clear how exactly it is decided who deserve protection and who do not. What is the deciding question? When and how is it asked? Those who do not “need” protection where are they returned to?

Despite these unanswered questions the Commission is satisfied and full of praises for the effectiveness of the EU Turkey Statement in controlling the numbers of irregular migration to acceptable low level of 90 -100 per cent. In other words, mission accomplished the smugglers’ business models are dismantled. Though at what expense and who are the most people affected in this process, the smugglers or those who are not perceived as in need of protection? Regardless, the Commission expresses its displeasure with the sluggish return rate for irregular staying of third country nationals in the EU Member States (European Commission, 2018a). Probable this is because the more people returned to wherever they came from then the hotspots problems will be solved.

### **2.4. Hot Spots Approach**

It is worth pointing out that the Hotspots Approach is considered an integral part of the EU support to the Member States in response to the 2015 perceived EU refugee crisis. That was designed to manage EU external



borders and through the help of the EU agencies asylum applications were supposed to be processed as soon as possible to facilitate relocation of asylum seekers to other Member States or move to the mainland (Mentzelopoulou, et al, 2018). Nevertheless, five years down the line from 2015 -2019 following the EU Turkey Statement in March 2016 asylum seekers and refugees are still facing rigid containment in Greece and Italy Hotspots. Despite the fact that it is well documented that Greece and Italy including Bulgaria do not have capacity to hold the huge numbers of the asylum seekers “immigrants” in the Hotspots Islands (European Commission, 2018b).

As the Commission acknowledged in its Progress Report 2018 that reception conditions, severe overcrowding remains a matter of severe concern in the in hotspots. Subsequently, there are tensions between asylum seekers “migrants” and communities due to intensifying pressure on infrastructure, management of waste and medical services (UNHCR, 2019a). In similar vein, the Fundamental Rights Agency (FRA) coincided that although the majority of EU Member States have adopted some form of written standards for reception conditions however they also reported major challenges in respecting these in practice (FRA, 2018). Médecins Sans Frontières (MSF) accused Greek authorities for persistent robbing vulnerable people of their dignity and health in an effort to deter others from coming, calling to an end of seemingly cruel, inhumane and skeptical policy (MSF, 2019). It must be acknowledged that on the 21<sup>st</sup> of August 2019, The World Organisation Against Torture (OMCT) published a report highlighting the ill-treatment of asylum seekers in Greece.

OMCT report state that due to Greek Containment Policy asylum seekers are trapped in conditions that are rapidly deteriorating, situations in camps are below human standards of living as overcrowding persist sanitation services are failing. There is a lack of support for individuals suffering from severe mental and physical health problems. The length of time spent on the islands as a result of the containment policy and slow processing of applications, means that individuals are forced to remain in harmful conditions (OMCT, 2019). The report described the situation for asylum seekers in Greek Island in gruesome details beyond belief that could happen in the EU. In spite of all this, in solidarity with Member States for managing migration issues since 2015 to 2019 the EU has rewarded Greece €2.2 billion, Italy €1 billion, Spain €800, million, Bulgaria €300 million, Malta and Cyprus €105 and€100 million respectively (European Commission, 2019a). On the other hand, the impacts of Dublin Regulation continue to be problematic even to the Member States that welcomed more asylum seekers such as Germany.

## **2.5. Impact of Dublin Regulation in Germany**

According to ACRE and AIDA 2019 report on “the implications of asylum procedures, reception and return” in Germany the reject and return of asylum seekers is legitimised by the creation of a dedicated State Office for Asylum and Returns. The report indicates that since the beginning of 2019, stakeholders have witnessed a change of practice on the enforcement of Dublin transfer decisions in the AnKER centres. Excessive force has been used to enforce Dublin return regulation, handcuffing is frequently witnessed as well, even in the case of pregnant women. Similar reports of frequent physical restraints, coupled with violence, family separations and

use of sedative medication have been made in Berlin and Lower Saxony in early 2019 ACRE and IADA claim. Adding that the transfers occur in odd hours of the night such as three to five a.m. in the mornings as a result some of the asylum seekers to abscond or not turn up. It is also claimed that police forces usually arrive late at night with dogs and trigger the fire alarm, causing severe distress and re-traumatisation to the residents, particularly to children. The report also claim that there are cases of people self-harming and suffering injuries such as broken limbs when trying to avoid apprehension by the police. Also if the applicant is not found in the room for the transfer pick-up, the police may return a few hours later to verify if he or she has returned, (ECRE and AIDA, 2019). This report supports the claims by the Médecins Sans Frontières has become the dumping ground for men, women and children that the EU has failed to protect (MSF, 2019).

## **2.6 Understanding EU Values as the Union's Mission Statement**

In order to understand the basic principles that underpin the CEAS it is considered vital to comprehend the EU values as they are the foundation of the EU Asylum System. The EU is founded on the values of respecting human dignity, freedom, democracy, equality, the rule of law and respecting human rights, including the rights of minorities. It is emphasised that these values unite all Member States and any country that does not recognise these cannot belong to the Union (European Parliament, 2014). Directive 2004/83/EC the objectives was to establish freedom, security and justice open to those who, forced by circumstances, legitimately seek protection in the Community. Furthermore, the Directive seeks to ensure full respect for human dignity and a right to seek asylum.

## **3.1. The Integration Challenges for Asylum Seekers and Refugees**

In order to understand the challenges and importance of asylum seekers and refugees' integration in the EU it is considered vital to appreciate the UN International Covenant on Economic, Social and Cultural Rights of 1976. That is taking into account that in response to the perceived 2015 EU Refugee Crisis in 2015, the EU Member States implemented integration strategies that are in accordance with the UN definition of refugees' integration.

Article I of the 1976 Covenant specifies that all peoples have the right of self-determination and by virtue of that right they freely determine their political status and freely pursue their economic, social and cultural development (OHCHR, 2019). Nonetheless, considering the current context of Asylum Seekers and Refugees in the EU one would be inclined to ask if this principle is omitted, deleted, suspended or if asylum seekers/refugees fall under the definition of "all peoples" particularly in times of crisis. Equally, it is noted that European Commission promotes the importance of fostering self-reliance that is helping the displaced people to live in dignity and contribute to their host societies (European Commission, 2016). Then again there is an issue of who is considered a genuine asylum seeker, who deserve refugee status at first instance and who is not considered legitimate as justified by the EU Turkey Statement relation to returning irregular immigrant to Turkey.

### 3.2. Challenges of Labour Market

As it is recognised that not all the asylum seekers become refugees it is equally understood that all refugees start as asylum seekers. Therefore in order to understand the challenges for refugees in labour markets it is important to start from the asylum seekers' perspective. Despite the fact that under the Reception Conditions Directive 2013 asylum seekers have the right to access employment. However, the labour markets for asylum seekers remain elusive in most Member States as they have different standards and requirements. For example, in Ireland asylum seekers can access employment nine months after registration, Greece and Italy soon after registration and Austria in six months (European Commission, 2018a). Nevertheless, even if asylum seekers access employment they face endless barriers due to documentation requirements such as proof of address, bank account statements, social security numbers, no access to public transport etc. For example, in Ireland there are asylum seekers that are living in Direct Provision for more than five years and they are not allowed to have a driving licence (Thomas, 2019). Additionally, asylum seekers also require a work permit that needs to be renewed every six months.

On the other hand, the studies show that there are no specific statistics that cover the specific employment of refugees and asylum seekers and this makes it difficult to assess their position in the labour markets. At the same time, as already stated asylum seekers and refugees are different as a result they experience different challenges in their social and economic lives. For example, in 2018 FRA in their Study "Being Black in Europe" in 2018 discovered that black people in the EU are the most discriminated people in every aspects of the society. It is either in gaining access to employment, housing, education, transportation etc. It is unfortunate that the colour of the skin plays an important role on how people are treated taking into consideration this behaviour is not only against the law also undermines the values of the EU. As FRA expressed his discontent stating that it is a reality both "shameful and infuriating" that racism based on the colour of a person's skin remains a "pervasive scourge" throughout the European Union and it is more disturbing that this discrimination affects most young people (FRA, 2018). It is important to acknowledge that the FRA research found that the discrimination of black people in the EU is directed and affect anyone who shows the blood of African descent. Also, it must be pointed out that since the perceived EU 2015 Refugee Crisis, discrimination and racism against minorities have dramatically increased in the EU (World Report, 2019). However, it is not clear how the EU Member States are planning to tackle this increase of racism and discrimination apart from implementing ineffective regulations and policies. As well as insisting on integration strategies that only target "immigrants" with emphasis on how to improve their skills. For example, in most if not all EU Member States "Migrants Integration Strategies" are designed in a manner that implies that all EU citizens are well educated, have no health problems, have no employment issues and are experts in how to live with "immigrants". This raises the questions on what is the education or what does it entail? Are the EU citizens educated in matters that matter? Should not all people be educated on values that matter to humanity particularly in times of social unrest that the EU is currently experiencing? Why integration strategies only target the minority not the majority? Why

focus on the hosted not the host? How can the EU achieve a Common European Asylum System without a common understanding of the issues that affect people and their integration to the Member States?

With that being said, there are good integration practices in other Member States for example, in Spain. In a notion that in every statistic there is a human being or person, the region of Murcia in 2017 authorities implemented a personalised plan and “one-stop-shop” for refugees, to support them in finding work and integrate into the community. It is an integration and inclusion programme that is designed to recognise that all people have the right to freely determine their economic and social lives. The programme is tailored for specific needs and as an opportunity for the refugees to show their skills from their countries and be trained accordingly. Additionally, the community help the refugees to obtain necessary documentation and job matching is adapted to each refugees needs and they also advice companies on how to employ refugees (European Commission, 2018a).

### **3.4. Education Challenges**

Studies show that there are insufficient mechanisms and strategies to establish the level of education among asylum seekers or proof of certificates and this can discourages further education for refugees. In 2018 the Human Rights Watch in Greece reported that it is not aware of any cases where children living in the government-run camps on the islands have been able to enrol in public primary or secondary schools, or where information about public school enrolment, transportation to the schools, or other support has been made available to them. The only formal education that has been made available to children in government-run camps is pre-school classes (WRW, 2018).

For example, in 2019 the UNHCR reported that 12, 480 refugees’ students enrolled in Greek public schools although, it is not clear for how long these students have been in Greece. Adding that at the same period 2, 700 children living in reception centres between the ages of 5 and 17 have not access to formal education. As a result there is an increase of informal education for these children and they are taught by the volunteers and the NGOs and these bodies all depend on the funding (UNHCR, 2019b). The following question is: What will happen to these children when the funding cease? What is the quality of education that these children are getting?

It should be noted that the access to education particular for asylum seekers’ children is problematic in many EU Member States, mainly due to the isolated locations, lack of public transport, financial problems, deportation orders, the list is endless. In summary there is so much uncertainty surrounding the lives of asylum seekers while waiting for the decision on their asylum applications.

### **3.5. Health Care Challenges**

It is worth recognising studies show that in most EU Member there are Migrants HealthCare Systems that are put in place however, they are complex and full of contradictions therefore it is not the intention of this paper to fully assess their effectiveness. Although it should be noted that there is a lack of specific health care

strategies that focus specific on targeting asylum seekers, with some exceptions for countries such as Germany and Croatia. According to the European Commission (2018a) in Croatia the specific Action Plan 2017-2019 was implemented providing set measures to provide better healthcare for beneficiaries of international protection focussing also focusing on overcoming linguistic and cultural problems. Also in Germany healthcare provisions for asylum seekers was set in 2015 by the Commission for Immigration, Refugees and Integration and there is no specific deadline of its end. In Ireland the Irish Intercultural Health Strategy set for 2007-2012 was never implemented. However, at present there is 2017 – 2020 Immigrants Integration Strategy set to address employment and health issues for “immigrants” however it is not clear how this is going to be achieved (European Commission, 2018a).

In Greece the Emergency HealthCare response to 2015 refugee crises was launched by the Greek Ministry of Health and implemented by the Hellenic Centre for Disease Control and Prevention (HCDCP). This was designed to address the sanitary and psychosocial needs of refugees living in the open camps. However, asylum-seekers and refugees on the Greek islands continue to face severe challenges in accessing medical screening and health provision due to administration/ medical teams understaffing (UNHCR, 2019b). Additionally, many of the Health Action Plans in EU Member States often fail to specify concrete actions to achieve goals and to assign responsibility for implementation (European Commission, 2018b).

According to the European Commission there are fears among EU citizens that asylum seekers, and immigrants carry infectious diseases although these fears are based on ill-founded notions (European Commission, 2018c). With that being said, other studies show that these concerns are real among the EU citizens regardless of whether they are true or not. For example, the Ministry of Social Affairs and Health in Finland claimed that there are concerns among Finish citizens that the fast increasing numbers of asylum seekers can increase diseases such as measles, tuberculosis, polio and diphtheria in the country (Kallinen, 2019).

Nevertheless, there is no evidence to substantiate these claims as the Finnish Institute of Health Care in 2018 emphasised that asylum seekers “immigrants” are not a uniform group. Therefore, their health problems should not be standardised as there are many factors that should be taken into consideration such as countries of origin, age of migration, their journeys to the EU, the functionality of the national healthcare system (THL, 2019). Other factors that should be acknowledged, is the length of time that asylum seekers and refugees are kept on reception centres and the conditions of these centres as they have a great impact on their overall wellbeing. As the European Commission stated that most immigrants are in fact young and health upon their arrival in the European Union (EWSI, 2018; THL, 2019).

#### **4.1. EU Asylum Legitimacy Consideration**

The EASO (2019) states that in six consecutive years there are top three countries that lodged higher numbers of international protection in the EU, Syria, 74, 800 Afghanistan 45, 300 and Iraq 42,100. However, EASO also seem to suggest that Afghanistan and Iraqi are considered irrelevant for international protection as compared to “relevant countries” Syria, Iran, Turkey, Venezuela and Georgia. However, is not clear why these

countries are relevant and others seemingly insignificant. In an attempt to make sense of the apparently irrational logic it is noted that Columbia, Venezuela and Georgia are claimed to be exempt from visa requirement when entering Schengen Area. In other words, these nationals have the higher chance of applying for asylum in the EU unlike the African nationals particularly from Western and Northern Africa as the visa requirement practices render them irregular immigrants that needs to be intercepted, driven or pushed back to Turkey, Libya or Morocco. For example, the Human Rights Watch in 2019 reported that Italy had systematically handed rescued people to Libyan Coast Guards despite the grave concerns over their safety. As authorities in Libya do not consider their country a country of asylum as a result asylum seekers are held in abhorrent conditions in detention centres with no easy access to help due to bureaucracy (Cochetel, 2018).

Also, the EASO (2018) states that, in a case of *A.E.A. v Greece*, the European Court of Human Rights (ECHR) ruled in favour of a Sudanese national who arrived in Greece in 2009 and to whom an automatic expulsion order was issued, preventing him from having access to the asylum procedure. Also, the European Centre for Constitutional and Human Rights ECCHR claim that collective expulsion of African nationals in the EU Member States is highlighted by the case of *N.D. and N.T. v Spain*, in 2017, of which the ECCHR ruled that Spain's push-back practices at the Spanish-Moroccan border are in violation of: Article 4 Protocol 4 that is the Prohibition of Collective Expulsions and Article 13 that is the Right to an Effective Remedy of the European Convention on Human Right, ECCHR, (2019). It is worth noting that the European Commission (2019b) strongly denies that the EU engages in pushback practices.

#### **4.2. The EU Asylum Policies: Restrictive or Selective?**

According to the ECCHR (2019) the incident that led to the above ruling is not isolated unfortunately Spanish authorities keep no records of these automatic expulsions therefore official figures are not available. In agreement, the Council of Europe Report in 2019 stated that practices and policies of pushbacks are an increasing phenomenon at Europe's borders and are in clear violation of the rights of asylum-seekers and refugees. Also abusing the right for people to seek asylum and the protection against nonrefoulement of which these rights are at the core of international refugee and human rights law (Strik, 2019). In similar lines (De Hass, 2018) concurred that immigration policies in Western countries are not restrictive they are just selective. De Hass claim that the criteria selection is based on skills, wealth or family characteristics of migrants. Nevertheless, this is understandable if this method of selection does not eradicate the distinction between an asylum seeker and a migrant. Conversely, De Hass seems to deny the claims that race plays an important role on the selection criteria on who is seen as deserving to enter EU and who is not, whilst, acknowledging that wealth plays an important part in the selection.

The burning question would be how many wealthy African nationals or to be more specific how many wealthy black African nationals who enter EU to seek asylum if there is any? Bearing in mind, the World Bank in 2018 reported that the asylum seekers in Greece are different from those in Italy as those in Greece mostly came as families from the Syrian Arab Republic, Iraq, and Afghanistan (EASO, 2018). Emphasising that based on past

EU recognition rates people from these countries are more likely to be granted international protection status. Whereas, those in Italy mostly single young men, from the West Africa therefore, highly unlikely that they would be granted any legal protection status in the European Union (World Bank, 2018). It should be note that reports of ill-treatment of refugees in detention centres are not unique to Libya as since 2015 Medicins Sans Frontieres. Raised concerns that immigration detention practices and conditions in Greece not only constitute a violation of national, European and international standards but also directly harm people's health and undermine their dignity (MSF, 2015). Since then the same organisation continue to claim that the EU and Greek authorities persist on robbing vulnerable people of their dignity and health in an effort to deter others from coming, calling to an end of seemingly cruel, inhumane and sceptical policy (MSF, 2019).

## 5. Conclusion

In a sense of honesty and fairness the European Union had fairly compensated its Member States in order to facilitate integration and improve reception conditions, provide accommodation, healthcare and food provisions for the asylum seekers and refugees. Just as Member States are well funded by the EU to manage their borders and ensure fairer procedures of asylum processes that protect all vulnerable people through a fair and just Common European Asylum System. However, history has shown and taught us that when incentives are not aligned with performance and ethical values that binds human family. Such as the full respect of human dignity, the rule of law, freedom, equality, and justice for all, things are bound to go wrong on a global scale. As we have seen and experienced with the Global Financial Crisis in 2008, Global Migration Crisis that erupted in 2014-2015, also known as the EU Refugee Crisis. Unfortunately, there are a lot of less well-off and less privileged countries around the world that are more affected by the immense numbers of displaced people and refugees as the statistics have shown. Although, it appears that the refugees' crisis has impacted only the developed Western countries due to the level of noise that has engulfed the EU Member States over the immigration issues. As a result it is difficult to filter through the noise and understand what is real and what is not real. However, there is no doubt that the EU has spent billions on immigration issues and there is no doubt that the EU Member States have benefited from these billions. The fact remains that today in 2019 people are still trapped in hotspots centres that were put as an emergency response to the 2015 refugee crisis and were not meant to be there for more than three months. It is true that there are those asylum seekers that consider themselves luck because they were given refugees status in the EU. However, as they enjoy their rights and freedoms they are daily reminded by their subconscious and appalling news from the refugee camps around the EU Member States. Knowing that members of their families, friends, and neighbours that are still trapped in the refugee camps may not be so lucky to experience the freedoms and rights that they have searched for, on long and painful journeys that they have taken to reach the Europe Union. At the same time the lucky ones are expected to integrate to their host communities regardless of the constant reminders of the fragility of their state of luck. It is very unfortunate and saddening to discover that the EU values (freedom, respect for human dignity, rule of law and justice) are not aligned with the strategies of the Common European Asylum System. Due to the mismatch of interests, incentives and values among Member States, wrong and conflicting

immigration policies have been implemented as a result the face of the CEAS is continuously changing, beyond recognition. On the other hand, it could be argued that not only asylum seekers and refugees are facing uncertain futures in the EU but also are uncertain on what does the EU stands for. More importantly does the EU remember the values that brought the Union together? In the spirit of fair share of responsibility and solidarity among EU Member States and the fact that of all the EU Member States, Greece is the most disadvantage country in terms of receiving and accommodating none EU nationals. This begs the question of why Greece is tolerating the non-cooperative stance of other Member States. Is €2.2 billion worth the pain and suffering not only of the asylum seekers and refugees but also of those Greek citizens who still care for humanity?

## References

- ACRE and AIDA (2019). Anker, Centres Report. Available at: <http://www.gmfus.org/sites/default/files/Germany%27s%20Triple%20Asylum%20Roulette.pdf> (Last accessed 1st September 2019).
- ANSA (2019). Greece: Labour Minister criticized for 'racist' refugees move. Available at: [http://www.ansamed.info/ansamed/en/news/sections/politics/2019/07/17/greece-labor-minister-criticized-for-racist-refugees-move\\_2d97ce3d-b02d-4b09-9c53-420cccf89e0e.html\\_](http://www.ansamed.info/ansamed/en/news/sections/politics/2019/07/17/greece-labor-minister-criticized-for-racist-refugees-move_2d97ce3d-b02d-4b09-9c53-420cccf89e0e.html_) (Last accessed 31st August 2019).
- CEAS (2019). Common European Asylum System: achievements during the legislative term 2014-2019. Available at: [http://www.europarl.europa.eu/RegData/etudes/BRIE/2019/608877/IPOL\\_BRI\\_\(2019\)608877\\_EN.pdf](http://www.europarl.europa.eu/RegData/etudes/BRIE/2019/608877/IPOL_BRI_(2019)608877_EN.pdf) (Last accessed 22nd August 2019).
- Cochetel, V. (2018). Libya: “Registration is a right for asylum seekers and refugees wherever they are”. Available at: <https://www.unhcr.org/blogs/registration-is-a-right-for-refugees/> (Last accessed 14th October 2019).
- Connor, P. (2018). The most common Mediterranean migration paths into Europe have changed since 2009. Available at: <https://www.pewresearch.org/fact-tank/2018/09/18/the-most-common-mediterranean-migration-paths-into-europe-have-changed-since-2009/> (Last accessed 29th August 2019).
- De Hass, H, Natter, K and Vezzoli, K. (2018). Growing Restrictiveness or Changing Selection? The Nature and Evolution of Migration Policies. *IMR, Sage*. 52 (2): 324–367.
- De Hass, H. (2008). Irregular Migration from West Africa to the Maghreb and the European Union. *International Organization for Migration*, 1 (1): 9-50.
- EASO (2016). Introduction to the Common European Asylum System for Courts and Tribunals. Available at: <https://www.easo.europa.eu/sites/default/files/public/BZ0216138ENN.PDF> (Last accessed 22nd August 2019).
- ECCHR (2019). Expulsions Conducted by Spain at the EU's External Borders Violate the European Convention on Human Rights. Available at: <https://www.ecchr.eu/en/case/the-case-of-nd-and-nt-v-spain/> (Last accessed 8th October 2019).
- European Commission (2018a). Asylum, Migration and Integration Fund (AMIF). Available at: [https://ec.europa.eu/home-affairs/financing/fundings/migration-asylum-borders/asylum-migration-integration-fund\\_en](https://ec.europa.eu/home-affairs/financing/fundings/migration-asylum-borders/asylum-migration-integration-fund_en). (Last accessed 1st September 2019).
- European Commission (2018b). Managing Migration in all its Aspects: Progress under the European Agenda on Migration. Available at: [https://ec.europa.eu/home-affairs/sites/homeaffairs/files/what-we-do/policies/european-agenda-migration/20181204\\_com-2018-798-communication\\_en.pdf](https://ec.europa.eu/home-affairs/sites/homeaffairs/files/what-we-do/policies/european-agenda-migration/20181204_com-2018-798-communication_en.pdf). (Last accessed 1st September 2019).
- European Commission (2018c). Personalised labour market integration and social inclusion for refugees in Murcia, Spain. Available at: [https://ec.europa.eu/regional\\_policy/en/projects/spain/personalised-labour-market-integration-and-social-inclusion-for-refugees-in-murcia-spain](https://ec.europa.eu/regional_policy/en/projects/spain/personalised-labour-market-integration-and-social-inclusion-for-refugees-in-murcia-spain). Last accessed 29th August 2019.
- European Commission (2019a). Common European Asylum. Available at: [https://ec.europa.eu/home-affairs/what-we-do/policies/asylum\\_en](https://ec.europa.eu/home-affairs/what-we-do/policies/asylum_en) (Last accessed 29th August 2019).



- European Commission (2019b). European Agenda on Migration Fact-Sheets. Available at: [https://ec.europa.eu/home-affairs/what-we-do/policies/european-agenda-migration/background-information\\_en](https://ec.europa.eu/home-affairs/what-we-do/policies/european-agenda-migration/background-information_en) (Last accessed 16th October, 2019).
- Eurostat (2019). Asylum Statistics. Available at: [https://ec.europa.eu/eurostat/statistics-explained/index.php/Asylum\\_statistics](https://ec.europa.eu/eurostat/statistics-explained/index.php/Asylum_statistics) (Last accessed 14th October 2019).
- Fili, A. (2018). Immigration detention in Greece: Contemporary Challenges. Available at: [https://www.law.ox.ac.uk/sites/files/oxlaw/greece\\_briefing\\_paper.pdf](https://www.law.ox.ac.uk/sites/files/oxlaw/greece_briefing_paper.pdf) (Last accessed 1st September 2019).
- Gostoli, Y. (2017). Their last resort: refugees in Greece go on hunger strike. Available at: <https://www.dw.com/en/their-last-resort-refugees-in-greece-go-on-hunger-strike/a-39725102> (Last accessed 29th August 2019).
- Hathaway, J.C and Cusick, A.K. (2000). Refugee Rights Are Not Negotiable. *University of Michigan Law School*. 14 (2): 481-539.
- HRW (2019). World Report. Available at: <https://www.hrw.org/world-report/2019/country-chapters/european-union> (Last accessed 14th October 2019).
- Kallinen, S. (2019). Social security and services of asylum seekers in Finland. Available at: <https://stm.fi/en/social-security-and-services-of-asylum-seekers-in-finland> (Last accessed 8th October 2019).
- Mentzelopoulou, M. M, and Luyten, K. (2018). Hotspots at EU external borders: State of Play. Available at: [http://www.europarl.europa.eu/RegData/etudes/BRIE/2018/623563/EPRS\\_BRI\\_\(2018\)623563\\_EN.pdf](http://www.europarl.europa.eu/RegData/etudes/BRIE/2018/623563/EPRS_BRI_(2018)623563_EN.pdf) (Last accessed 8th October 2019).
- MOCT (2019). Greece: No End in Sight: The Mistreatment of Asylum Seekers in Greece. Available at: [https://www.omct.org/monitoring-protection-mechanisms/reports-and-publications/greece/2019/08/d25483/#\\_msocom\\_1](https://www.omct.org/monitoring-protection-mechanisms/reports-and-publications/greece/2019/08/d25483/#_msocom_1) (Last accessed 16th October, 2019).
- MSF (2019). Greece: three years of cruel, inhumane and cynical treatment of migrants and refugees .Available at: <https://www.doctorswithoutborders.org/what-we-do/news-stories/news/greece-three-years-cruel-inhumane-and-cynical-treatment-migrants-and>. (Last accessed 1st September 2019).
- Niarchos, N. (2019). On a Greek Island That Welcomed Migrants, Residents and Refugees Feel Abandoned. Available at: <https://www.newyorker.com/news/dispatch/on-a-greek-island-that-welcomed-migrants-residents-and-refugees-feel-abandoned> (Last accessed 31st August 2019).
- OHCHR (1993). *Fact Sheet No. 20, Human Rights and Refugees*. Available at: <https://www.refworld.org/docid/4794773f0.html> (Last accessed 5th September).
- OHCHR (2019). Statement to the media by the United Nations Working Group of Experts on People of African Descent, on the conclusion of its official visit to Belgium, 4-11 February 2019. Available at: <https://www.ohchr.org/en/NewsEvents/Pages/DisplayNews.aspx?NewsID=24153&LangID=E> (Last accessed 16th October, 2019).
- Robila, M. (2018). Refugees and Social Integration in Europe. Available at: [https://www.un.org/development/desa/family/wpcontent/uploads/sites/23/2018/05/Robila\\_EGM\\_2018.pdf](https://www.un.org/development/desa/family/wpcontent/uploads/sites/23/2018/05/Robila_EGM_2018.pdf) (Last accessed 22nd August 2019).
- RSA (2019). Structural failure: why Greece's reception system failed to provide sustainable solutions. Available at: <https://rsaegean.org/wp-content/uploads/2019/06/201906-STRUCTURAL-FAILURE-Why-Greece%E2%80%99s-reception-system-failed-f.pdf> (Last accessed 1st September 2019).
- Schmälder J. (2018). A European response to non-compliance: the Commission's enforcement efforts and the Common European Asylum System. *West European Politics*, 41 (6): 1330-1353.
- Schneider, G. (2019). Germany's Triple Asylum Roulette. Available at: <http://www.gmfus.org/sites/default/files/Germany%27s%20Triple%20Asylum%20Roulette.pdf> (Last accessed 1st September 2019).
- SMF (2015). Thousands of migrants and asylum seekers stranded in precarious conditions across islands. Available at: <https://www.msf.org/greece-thousands-migrants-and-asylum-seekers-stranded-precarious-conditions-across-islands> (Last accessed 22nd August 2019).
- Strik, T. (2019). Pushback policies and practice in Council of Europe member States. Available at: <https://reliefweb.int/sites/reliefweb.int/files/resources/20190531PushbackPolicies-EN.pdf> (Last accessed 14th October 2019).
- THL (2019). The health and welfare of asylum seekers. Available at: <https://thl.fi/en/web/migration-and-cultural-diversity/immigrants-health-and-wellbeing> (Last accessed 8th October 2019).
- Thomas, C. (2019). Considerable challenges: Direct Provision residents facing employment barriers despite right-to-work. Available at: <https://www.thejournal.ie/considerable-challenges-direct-provision-residents->

- facing-employment-barriers-despite-right-to-work-4535651-Mar2019/ (Last accessed 16th October, 2019).
- TM (2019). Readmission Agreement with EU Suspended, Turkish FM Says. Available at: [https://www.turkishminute.com/2019/07/22/readmission-agreement-with-eu-suspended-turkish-fm-says/?fbclid=IwAR2PG9bDynCj32pu3CiopLf7iIDN\\_-uEo4Djrv1srX-jBKIIAHC3pKa4UUU](https://www.turkishminute.com/2019/07/22/readmission-agreement-with-eu-suspended-turkish-fm-says/?fbclid=IwAR2PG9bDynCj32pu3CiopLf7iIDN_-uEo4Djrv1srX-jBKIIAHC3pKa4UUU) (Last accessed 1st September 2019).
- UNHCR (2004). Protracted Refugee situations. Available at: <https://www.unhcr.org/en-ie/excom/standcom/40c982172/protracted-refugee-situations.html> (Last accessed 16th October, 2019).
- UNHCR (2019a). Sea Arrivals Dashboard. Available at: <https://reliefweb.int/sites/reliefweb.int/files/resources/70993.pdf> (Last accessed 31st August 2019).
- UNHCR (2019b). Managing Migration. EU Financial Support to Greece. Available at: [https://ec.europa.eu/home-affairs/sites/homeaffairs/files/what-we-do/policies/european-agenda-migration/201907\\_managing-migration-eu-financial-support-to-greece\\_en.pdf](https://ec.europa.eu/home-affairs/sites/homeaffairs/files/what-we-do/policies/european-agenda-migration/201907_managing-migration-eu-financial-support-to-greece_en.pdf) (Last accessed 1st September 2019).
- European Parliament (2019). Legislative Train Schedule States Navigation Menu Departure Demands Departures Expected Arrivals On Hold Arrived Derailed Legislations Menu: Arrived 21 1st Emergency Relocation Scheme 2nd Emergency RE. Available at: <http://www.europarl.europa.eu/legislative-train/theme-towards-a-new-policy-on-migration/file-eu-turkey-statement-action-plan> (Last accessed 16th October, 2019).
- World Bank (2018). Asylum Seekers in the European Union: Building Evidence to Inform Policy Makers. Available at: <http://documents.worldbank.org/curated/en/832501530296269142/pdf/127818-V1-WP-P160648-PUBLIC-Discovered-7-2-2018.pdf> (Last accessed 14th October 2019).

## **TOPIC 7: FINANCE AND INVESTMENTS**

## **7.1. Financial contagion and volatility spillover: An exploration into crude oil future market and 3Y, 4Y and 5Y CDS markets**

*Konstantinos Tsiaras<sup>1</sup>*

### **Abstract**

This paper seeks to investigate the volatility transmission from crude oil future contracts to the private CDS markets of Germany and France. I quantify volatility spillover effects by employing a dynamic conditional correlation (DCC) Generalized ARCH (GARCH) model. The under investigation period is during 2011-2018. I focus on the CDSs of the biggest banks in Germany and France namely: Société Générale and Deutsche Bank AG using 3-, 4- and 5-year maturity CDSs. According to dynamic conditional correlations, I find evidence of contagion for the pairs of markets Societe Generale CDS 3Y-Crude oil futures, Societe Generale CDS 4Y-Crude oil futures and Societe Generale CDS 5Y-Crude oil futures for two time periods (10/2014-12/2014 and 04/2017-11/2017). The results are of interest to individual investors, which diversify their portfolios through international derivative investment.

**JEL codes:** C58, C61, G11, G15

**Key Words:** Financial contagion, Global Financial Crisis, cDCC-GARCH model, crude oil future market, CDS market

### **1. Introduction**

The purpose of this paper is to investigate the volatility transmission between crude oil future contracts to the private CDS markets of Germany and France. I consider the 3-, 4- and 5-year maturity CDSs of Société Générale and Deutsche Bank AG during the period from 2011 to 2018. I quantify volatility spillovers using a dynamic conditional correlation (DCC) Generalized ARCH (GARCH) model.

The motivation for examining volatility spillover effects is as follows. First, there is no other empirical research investigating the conditional second moments of the distribution of between crude oil future contracts with the 3-, 4- and 5-year maturity CDSs of Société Générale and Deutsche Bank AG. Second, the existence of volatility transmission between the above markets is of great importance, since investors may improve their portfolio exposures to the under investigation markets.

Furthermore, three interesting aspects emerged from this paper. Firstly, based on the descriptive statistics, Société Générale CDS 3Y demonstrates the largest fluctuations compared to the rest markets, indicating that Société Générale CDS 3Y is the most immune CDS market. Secondly, the results of the cDCC- GARCH(1,1) model show volatility spillovers. Thirdly, dynamic conditional correlations show evidence of contagion for the pairs of markets: Societe Generale CDS 3Y-Crude oil futures, Societe Generale CDS 4Y-Crude oil futures and Societe Generale CDS 5Y-Crude oil futures for two periods: 10/2014-12/2014 and 04/2017-11/2017.

---

<sup>1</sup> Department of Economics, University of Ioannina, University Campus, 45110 Ioannina, Greece, Email: konstantinos.tsiaras1988@gmail.com

This paper is structured as follows. Section 2 presents the literature review and Section 3 shows the data used for the purpose of the analysis. Section 4 gives a brief on the econometric methods used in this study. Section 5 provides an explicit analysis of the econometric results. Section 6 summarizes the major findings.

## 2. Literature review

The main body of the current literature explores the linkages between CDS markets with financial markets (Lake and Apergis 2009; Belke and Gokus 2011; Fonseca and Gottschalk; 2012; Tokat 2013). Lake and Apergis (2009) investigate the spillovers among the US and European (German, UK and Greek) 5-year maturity CDS spreads and equity returns in the period 2004-2008. By making use of daily observations, they employ an MVGARCH-M model, finding evidence of spillover effects. Belke and Gokus (2011) examine the volatility transmission among the daily equity prices, CDS premiums and bond yields returns for four large US banks for the period 2006-2009. By employing a BEKK-GARCH model, they capture spillover effects. Fonseca and Gottschalk (2012) examine the volatility spillovers among CDS premium and equity returns for Australia, Japan, Korea and Hong Kong at firm and index level. They use weekly data during 2007-2010 and they show empirical evidence of spillover effects. Tokat (2013) empirically<sup>2</sup> investigates the spillover effects between daily 5-year maturity sovereign CDS values for Brazil and Turkey denominated in USD, iTraxx XO index and CDX index during the period from 2005 to 2011. He employs a full BEKK-GARCH model and he proves empirically the existence of spillovers.

Additionally, there are a number of studies investigating linkages between oil crude oil future contracts with macroeconomic figures, financial markets and commodities. (Haigh and Holt 2002; Guo and Kliesen 2005; Malik and Hammoudeh 2007; Driesprong, Jacobsen, and Maat 2008; Geman and Kharoubi 2008; Ewing and Malik 2010; Wu, Guan, and Myers 2011). Haigh and Holt (2002) develop a theoretical model for a representative energy trader that simultaneously employs crude oil, heating oil, and natural gas futures to hedge future price uncertainty. They use weekly spot and future price data during the period from 7<sup>th</sup> December 1984 until 26<sup>th</sup> September 1997 for crude oil, unleaded gasoline and 2 heating oil sourced from Bridge/CRB. They find that the multivariate GARCH methodology, which takes into account volatility spillovers between markets, reduces significantly the uncertainty. Guo and Kliesen (2005) examine whether crude oil futures prices has a negative and significant effect on future gross domestic product (GDP) growth. They use daily values of crude oil futures traded on New York Mercantile Exchange (NYMEX) during the period 1984-2004 by employing granger causality tests. The results confirm their hypothesis of a negative effect from crude oil futures prices to future gross domestic product (GDP) growth. Malik and Hammoudeh (2007) examine the volatility and shock transmission mechanism among US equity, global crude oil market, and equity markets of Saudi Arabia, Kuwait, and Bahrain. They use daily data for a period from 12<sup>th</sup> February 1994 to 25<sup>th</sup> December 2001 sourced from Reuters. They use a multivariate GARCH model, finding significant volatility

---

<sup>2</sup> Financial researchers and academics are interested to 5-year maturity CDSs, investigating the underlying contagion mechanisms in the short-term period.

and shock transmission among US equity, Gulf equity and global crude oil markets. Driesprong, Jacobsen, and Maat (2008) examine the relationship between changes in oil prices with stock market returns. They use monthly data during the period from October 1973 until April 2003. They run regressions finding evidence of predictability of stock returns when incorporating oil price changes in their model. Geman and Kharoubi (2008) examine the diversification effect from including crude oil futures into a portfolio of stocks. They use daily data for a period from 2<sup>nd</sup> May 1990 to 1<sup>st</sup> September 2006. By using copula functions, they find that the desirable negative correlation effect is more pronounced in the distant maturity oil futures. Ewing and Malik (2010) investigate the way that shocks affect the volatility of oil prices over time. They use daily data for the period from 1<sup>st</sup> July 1993 until 30<sup>th</sup> June 2008. By employing univariate GARCH models, they find that oil shocks have a strong initial impact on volatility but dissipate very quickly. Wu, Guan, and Myers (2011) investigate spillovers across two types of market, focusing on the impact of external shocks from the crude oil futures market on corn prices, examining corn cash and futures markets simultaneously. They use weekly data for a period from 2<sup>nd</sup> January 1992 until 30<sup>th</sup> June 2009. Using a volatility spillover model, they find evidence of significant spillovers from crude oil prices to corn futures prices and show that these spillover effects are time-varying.

### 3. Data and descriptive statistics

The data on seven CDS and futures markets namely, Crude oil, Société Générale CDS 3Y, Société Générale CDS 4Y, Société Générale CDS 5Y, Deutsche Bank AG CDS 3Y, Deutsche Bank AG CDS 4Y and Deutsche Bank AG CDS 5Y, used in this study are obtained from from *Datastream® Database* (Figure 1 below). Crude oil is traded on NYMEX (New York Mercantile Exchange) and we use its setting price (NYM-LIGHT CRUDE OIL CONTINUOUS - SETT. PRICE). In addition, we use the premium mid prices for CDSs (SNR CR - CDS PREM. MID). We set the time period August 1, 2011-February 5, 2018 (1702 obs.), one week before the black Monday, when USA and global stock markets crashed, following the Friday night credit rating downgrade by Standard and Poor's of the USA sovereign debt from AAA to AA+. We generate the market returns using the equation  $r_t = \log(p_t) - \log(p_{t-1})$ , where  $p_t$  is the price of future market on day  $t$  and  $p_{t-1}$  is the price of future market on day  $t-1$ .

**FIGURE 1**  
ACTUAL SERIES OF THE MARKETS

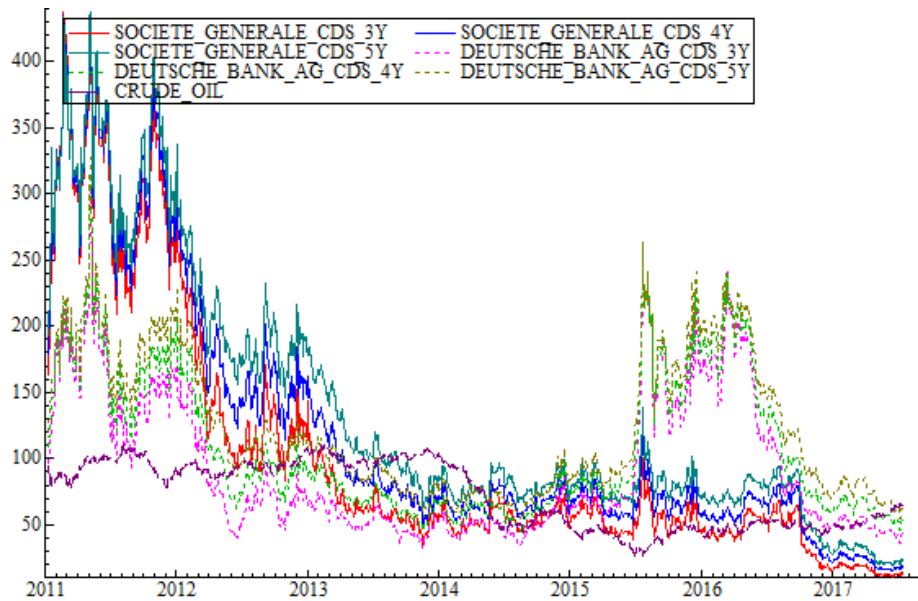

Notes: The lines represent the 3-, 4- and 5-year maturity CDS markets of Societe Generale and Deutsche Bank AG and the crude oil futures.

Table 1 below shows descriptive statistics of CDS and futures markets returns. Crude oil exhibits the highest mean value (-0,00010001). According to the highest maximum (0,15263) and the lowest minimum (-0,17832) and the highest std. deviation (0,021968) value, Société Générale CDS 3Y demonstrates the largest fluctuations. All markets are positively skewed, except the case of Société Générale CDS 3Y. In addition, all market returns state excess kurtosis. Jarque-Bera statistic results reject the null hypothesis of normality for all markets. ADF (Dickey and Fuller 1979) test results, reject unit root at 90%.

**TABLE 1**  
SUMMARY STATISTICS OF DAILY MARKET RETURNS, SAMPLE PERIOD: 1<sup>ST</sup>AUGUST, 2011 – 5<sup>TH</sup>FEBRUARY, 2018

	Crude oil futures	Société Générale CDS 3Y	Société Générale CDS 4Y	Société Générale CDS 5Y	Deutsche Bank AG CDS 3Y	Deutsche Bank AG CDS 4Y	Deutsche Bank AG CDS 5Y
<b>Panel A: descriptive statistics</b>							
Mean	-0,00010001	-0,00063503	-0,00058018	-0,00053869	-0,00020373	-0,00017834	-0,00016166
Minimum	-0,046879	-0,17832	-0,15129	-0,13351	-0,14712	-0,12917	-0,10626
Maximum	0,050471	0,15263	0,12664	0,10764	0,10836	0,10803	0,1076
Std. Deviation	0,0089838	0,021968	0,018166	0,016192	0,019925	0,01713	0,015375
<b>Panel B: Normality Test</b>							
Skewness	0,13420**	-0,020508	0,12255**	0,19544***	0,17340***	0,16012***	0,24163***
t-Statistic	2,2608	0,34551	2,0647	3,2926	2,9213	2,6976	4,0709
p-Value	0,023769	0,72971	0,038951	0,00099258	0,0034860	0,0069833	4,6836e-005
Excess Kurtosis	3,3131***	6,3057***	6,0935***	6,1160***	4,4060***	5,2038***	5,6732***
t-Statistic	27,925	53,149	51,360	51,550	37,137	43,861	47,817
p-Value	1,3202e-171	0,00000	0,00000	0,00000	0,00000	0,00000	0,00000
Jarque-Bera	782,63	2816,6	2634,4	2660,4	1383,6	1925,4	2296,3
p-Value	1,1305e-170	0,00000	0,00000	0,00000	3,5654e-301	0,00000	0,00000
<b>Panel C: Unit Root Test</b>							
ADF Test	-23,9799	-23,3547	-23,0817	-23,2444	-23,1639	-23,6349	-23,9865
Critical value: 1%	-2,56572	-2,56572	-2,56572	-2,56572	-2,56572	-2,56572	-2,56572
Critical value: 5%	-1,94093	-1,94093	-1,94093	-1,94093	-1,94093	-1,94093	-1,94093
Critical value: 10%	-1,61663	-1,61663	-1,61663	-1,61663	-1,61663	-1,61663	-1,61663

Notes: Panel A presents the descriptive statistics. Panel B shows the normality test. Panel C demonstrates the unit root tests. ADF Test is with 2 lags. \*\* and \*\*\* denote statistical significance at the 5% and 1% levels, respectively.

Appendix A plots the actual and the return series for Crude oil futures (Graph A), Societe Generale CDS 3Y (Graph B), Societe Generale CDS 4Y (Graph C), Societe Generale CDS 5Y (Graph D), Deutsche Bank AG CDS 3Y (Graph E), Deutsche Bank AG CDS 4Y (Graph F) and Deutsche Bank AG CDS 5Y (Graph G). return series exhibit high volatility levels. The above suggest the presence of heteroskedasticity.

#### 4. The model

##### 4.1 Univariate GARCH model

The cDCC model proposed by Aielli (2009) involves two stages. In the first stage, we estimate  $h_t$  by employing univariate volatility models for the CDS and crude oil futures returns. We generate the daily logarithmic returns.

$$y_t = \mu + \varepsilon_t, \text{ with } t = 1, \dots, T \quad (1)$$

$$\text{with } \varepsilon_t = \sqrt{h_t} u_t \quad (2)$$

where  $\mu \in [0, \infty)$ ,  $\varepsilon_t \sim N(0, H_t)$ ,  $u_t \sim N(0, 1)$  and  $h_t$  is positive with probability one. In our paper we use Bollerslev's (1986) GARCH(1,1) model to generate the conditional variance ( $h_t$ ).  $h_t$  is depending on  $h_t$  and  $\varepsilon_t$  for each market lagged one period. The equation of  $h_t$  can be expressed as:

$$h_t = \omega + a\varepsilon_{t-1}^2 + bh_{t-1} \quad (3)$$

where  $\omega > 0$ ,  $a \geq 0$  and  $b \geq 0$  is sufficient for the conditional variance to be positive.

##### 4.2. Multivariate cDCC model

In the second stage, we use the standard deviations from the first stage to transform the standardized residuals. Then, we use them to estimate the parameters of the conditional correlation. We define the multivariate conditional variance matrix ( $H_t$ ) ( $N \times N$  matrix), using the cDCC model of Aielli (2009) as follows:

$$H_t = D_t R_t D_t \quad (4)$$

where  $D_t = \text{diag} \left( h_{11t}^{\frac{1}{2}} \dots h_{NNt}^{\frac{1}{2}} \right)$  is the conditional variance obtained from the univariate GARCH(1,1) model, and  $R_t = \text{diag} \left( q_{11,t}^{-\frac{1}{2}} \dots q_{NN,t}^{-\frac{1}{2}} \right) Q_t \text{diag} \left( q_{11,t}^{-\frac{1}{2}} \dots q_{NN,t}^{-\frac{1}{2}} \right)$  is the conditional correlation matrix, with  $N$  is the number of markets ( $i = 1, \dots, N$ ).

To obtain cDCC model, first, we define  $P_t = \text{diag} \left( q_{11,t}^{-\frac{1}{2}} \dots q_{NN,t}^{-\frac{1}{2}} \right)$  and  $u_t^* = P_t u_t$ . The cDCC model of Aielli (2009) is an extension of the DCC model of Engle (2002). In the cDCC model,  $Q_t = (q_{ij,t})$  ( $N \times N$  symmetric positive definite matrix) is defined as follows:

$$Q_t = (1 - \alpha - \beta) \bar{Q} + \alpha u_{t-1}^* u_{t-1}^{*'} + \beta Q_{t-1} \quad (5)$$



where  $\bar{Q}$  is the  $N \times N$  unconditional variance matrix of  $u_t^*$  (since  $E[u_t^* u_t^{*'} | \Omega_{t-1}] = Q_t$ )<sup>3</sup>.  $\alpha$  and  $\beta$  are nonnegative scalar parameters, satisfying  $\alpha + \beta < 1$ .

For the cDCC model, the estimation of the matrix  $\bar{Q}$  and the parameters  $\alpha$  and  $\beta$  are intertwined, since  $\bar{Q}$  is estimated sequentially by the correlation matrix of the  $u_t^*$ . To obtain  $u_t^*$  we need however a first step estimator of the diagonal elements of  $Q_t$ . Thanks to the fact that the diagonal elements of  $Q_t$  do not depend on  $\bar{Q}$  (because  $\bar{Q}_{ii} = 1$  for  $i = 1, \dots, N$ ), Aielli (2009) proposed to obtain these values  $q_{11,t}, \dots, q_{NN,t}$  as follows:

$$q_{ii,t} = (1 - \alpha - \beta) + \alpha u_{i,t-1}^2 + \beta q_{ii,t-1} \quad (6)$$

for  $i = 1, \dots, N$ . In short, given  $\alpha$  and  $\beta$ , we can compute  $q_{11,t}, \dots, q_{NN,t}$  and thus  $u_t^*$ , then we can estimate  $\bar{Q}$  as the empirical covariance of  $u_t^*$ .

### 4.3. Log-likelihood estimation

We use Full Information Maximum Likelihood (FIML) methods with student's t-distributed errors to estimate the model as follows:

$$\sum_{t=1}^T \left[ \log \frac{\Gamma(\frac{\nu+w}{2})}{[\nu\pi]^{\frac{w}{2}} \Gamma(\frac{\nu}{2}) \nu^{-\frac{w}{2}}} - \frac{1}{2} \log (|H_t|) - \left(\frac{w+\nu}{2}\right) \log \left[ 1 + \frac{\varepsilon_t' H_t^{-1} \varepsilon_t}{\nu-2} \right] \right] \quad (7)$$

where  $\Gamma(\cdot)$  is the Gamma function,  $w$  is the number of equations,  $\nu$  is the degrees of freedom and  $\varepsilon_t$  is the  $w$  vector of standardized residuals.

## 5. Empirical results

This section is organized in three sub-sections. Sub-section 1 presents the empirical results from the MGARCH model. Sub-section 2 demonstrates the estimates of the dynamic conditional correlations.

**TABLE 2**  
 ESTIMATES OF GARCH(1,1) MODEL, SAMPLE PERIOD: 1<sup>ST</sup> AUGUST, 2011 – 5<sup>TH</sup> FEBRUARY, 2018

	Crude oil futures-Société Générale CDS 3Y		Crude oil futures -Deutsche Bank AG CDS 3Y	
	Crude oil futures	Société Générale CDS 3Y	Crude oil futures	Deutsche Bank AG CDS 3Y
constant ( $\mu$ )	0,00035	-0,000383	0,000038	-0,000396
t-Statistic	0,2186	-0,7485	0,2344	-0,9171
p-Value	0,8270	0,4543	0,8147	0,3592
constant ( $\omega$ )	0,448754	0,844253**	0,434359	0,127462**
t-Statistic	1,860	2,099	1,908	2,439
p-Value	0,0631	0,0360	0,0566	0,0148
ARCH ( $a$ )	0,061119***	0,126572***	0,061623***	0,096656***
t-Statistic	3,901	3,215	4,147	3,849
p-Value	0,0001	0,0013	0,0000	0,0001
GARCH ( $b$ )	0,933669***	0,706792***	0,933374***	0,875135***

<sup>3</sup> Aielli (2009) has shown that the estimation of  $\bar{Q}$  as the empirical correlation matrix of  $u_t$  is inconsistent because:  $E[u_t u_t'] = E[E[u_t' u_t | \Omega_{t-1}]] = E[R_t] \neq E[Q_t]$ .

t-Statistic	57,16	7,239	61,16	28,63
p-Value	0,0000	0,0000	0,0000	0,0000

Notes: Table 2 presents the results of univariate GARCH(1,1) model (Equation 1 and Equation 3). \*\* and \*\*\* denote statistical significance at the 5% and 1% levels, respectively. Mean equation:  $y_t = \mu + \varepsilon_t$ , with  $t = 1, \dots, T$ . Variance equation:  $h_t = \omega + a\varepsilon_{t-1}^2 + bh_{t-1}$ .

**TABLE 3**  
ESTIMATES OF GARCH(1,1) MODEL, SAMPLE PERIOD: 1<sup>ST</sup> AUGUST, 2011 – 5<sup>TH</sup> FEBRUARY, 2018

	Crude oil futures-Société Générale CDS 4Y		Crude oil futures-Deutsche Bank AG CDS 4Y	
	Crude oil futures	Société Générale CDS 4Y	Crude oil futures	Deutsche Bank AG CDS 4Y
constant ( $\mu$ )	0,000039	-0,000416	0,000045	-0,000499
t-Statistic	0,2387	-0,9372	0,1780	-1,373
p-Value	0,8113	0,3488	0,7810	0,1700
constant ( $\omega$ )	0,451151	0,514385**	0,438782	0,078536**
t-Statistic	1,876	2,013	1,925	2,452
p-Value	0,0608	0,0442	0,0544	0,0143
ARCH ( $a$ )	0,060644***	0,139357***	0,061492***	0,090994***
t-Statistic	3,923	2,669	4,168	3,899
p-Value	0,0001	0,0077	0,0000	0,0000
GARCH ( $b$ )	0,933922***	0,715082***	0,933390***	0,884982***
t-Statistic	57,65	6,709	61,52	31,56
p-Value	0,0000	0,0000	0,0000	0,0000

Notes: Table 2 presents the results of univariate GARCH(1,1) model (Equation 1 and Equation 3). \*\* and \*\*\* denote statistical significance at the 5% and 1% levels, respectively. Mean equation:  $y_t = \mu + \varepsilon_t$ , with  $t = 1, \dots, T$ . Variance equation:  $h_t = \omega + a\varepsilon_{t-1}^2 + bh_{t-1}$ .

**TABLE 4**  
ESTIMATES OF GARCH(1,1) MODEL, SAMPLE PERIOD: 1<sup>ST</sup> AUGUST, 2011 – 5<sup>TH</sup> FEBRUARY, 2018

	Crude oil futures-Société Générale CDS 5Y		Crude oil futures-Deutsche Bank AG CDS 5Y	
	Crude oil futures	Société Générale CDS 5Y	Crude oil futures	Deutsche Bank AG CDS 5Y
constant ( $\mu$ )	0,000040	-0,000423	0,000052	-0,000546
t-Statistic	0,2490	-1,074	0,3185	-1,691
p-Value	0,8034	0,2831	0,7501	0,0909
constant ( $\omega$ )	0,452725	0,380671	0,444297	0,057582**
t-Statistic	1,889	1,907	1,949	2,483
p-Value	0,0590	0,0567	0,0514	0,0131
ARCH ( $a$ )	0,060334***	0,151670***	0,061414***	0,089231***
t-Statistic	3,943	2,808	4,203	4,105
p-Value	0,0001	0,0050	0,0000	0,0000
GARCH ( $b$ )	0,934133***	0,713092***	0,933343***	0,888493***
t-Statistic	58,12	6,593	62,04	34,08
p-Value	0,0000	0,0000	0,0000	0,0000

Notes: Table 2 presents the results of univariate GARCH(1,1) model (Equation 1 and Equation 3). \*\* and \*\*\* denote statistical significance at the 5% and 1% levels, respectively. Mean equation:  $y_t = \mu + \varepsilon_t$ , with  $t = 1, \dots, T$ . Variance equation:  $h_t = \omega + a\varepsilon_{t-1}^2 + bh_{t-1}$ .

### 5.1 Empirical results of the cDCC- GARCH (1,1) model

Tables 2, 3 and 4 above presents the estimated GARCH (1,1) model. Estimates of the mean equation (Equation 1) show statistical insignificant constant ( $\mu$ ) for all markets. Estimates of the variance equation (Equation 3) reveal statistical significant constant ( $\omega$ ) for Société Générale CDS 3Y and 4Y, as well as for Deutsche Bank AG CDS 3Y, 4Y and 5Y. All ARCH ( $\alpha$ ) and GARCH effects ( $b$ ) are statistically significant.

Table 5 above presents the estimates of cDCC model, the diagnostic tests and the information criteria. Estimates of cDCC model (Equation 7 and Equation 9) reveal statistical significant average correlation (CORij) between Crude oil and Deutsche Bank AG CDS 3Y, 4Y and 5Y. All the ARCH ( $\alpha$ ) and GARCH effects ( $\beta$ ) are statistically significant. In addition, we see the estimates of log-likelihood. Estimates of  $\chi^2(8)$  statistics

suggest the rejection of the null hypothesis of no spillovers at 1% significance level. Ljung-Box test results (Hosking 1980; Li-McLeod 1983) show evidence of no serial autocorrelation, suggesting no misspecification errors. Additionally, estimates of the AIC and SIC information criteria are stated.

Figure 2 below presents the evolution of conditional variances for all the variables. We observe a tremble trend for all markets. In addition, important economic shocks are observable i.e. the Brexit decision in June 2016, among others.

In figure 3 below, we report the estimates of conditional covariances, generated by cDCC-GARCH(1,1) model for all the pairs of markets. Results state clearly the behavior of spillovers, as we can notice the existence of extreme volatility levels.

**TABLE 5**  
ESTIMATES OF cDCC MODEL, DEGREES OF FREEDOM, LOG-LIKELIHOOD, DIAGNOSTIC TESTS AND INFORMATION CRITERIA

	ESTIMATES OF cDCC MODEL, DEGREES OF FREEDOM, LOG-LIKELIHOOD, DIAGNOSTIC TESTS AND INFORMATION CRITERIA					
	Crude oil futures- Société Générale CDS 3Y	Crude oil futures- Deutsche Bank AG CDS 3Y	Crude oil futures- Société Générale CDS 4Y	Crude oil futures- Deutsche Bank AG CDS 4Y	Crude oil futures- Société Générale CDS 5Y	Crude oil futures- Deutsche Bank AG CDS 5Y
<b>Panel A: estimates of cDCC model</b>						
Average COR <sub>it</sub>	-0,112363	-0,120549**	-0,112669	-0,128371***	-0,119266	-0,139105***
t-Statistic	-1,592	-2,396	-1,732	-2,612	-1,919	-2,895
p-Value	0,1117	0,0167	0,0835	0,0091	0,0551	0,0038
alpha ( $\alpha$ )	0,015119***	0,011674**	0,014115**	0,010920**	0,013557**	0,010605***
t-Statistic	2,647	2,491	2,391	2,476	2,167	2,476
p-Value	0,0082	0,0128	0,0169	0,0134	0,0304	0,0134
beta ( $\beta$ )	0,9777859***	0,979069***	0,978193***	0,980101***	0,978216***	0,980077***
t-Statistic	115,5	134,6	105,6	138,5	92,75	137,6
p-Value	0,0000	0,0000	0,0000	0,0000	0,0000	0,0000
degrees of freedom ( $df$ )	5,619929***	5,807968***	5,784588***	5,979557***	5,797616***	5,929854***
t-Statistic	12,50	12,18	11,93	11,76	11,97	12,03
p-Value	0,0000	0,0000	0,0000	0,0000	0,0000	0,0000
log-likelihood	9987,103	10229,283	10316,928	10509,708	10532,610	10719,991
<b>Panel B: diagnostic tests</b>						
$\chi^2(4)$	1359,1**	459,21**	1157,7**	432,97**	1226,3**	453,48**
p-Value	0,0000	0,0000	0,0000	0,0000	0,0000	0,0000
Hosking (50)	206,559	218,145	216,377	221,851	213,930	219,604
p-Value	0,3602921	0,1802859	0,2030860	0,1382624	0,2375835	0,1628158
Hosking <sup>2</sup> (50)	189,958	168,803	178,726	178,411	181,762	174,386
p-Value	0,6465818	0,9347746	0,8335113	0,8377002	0,7897824	0,8856128
Li-McLeod (50)	207,015	218,685	216,862	222,308	214,491	220,022
p-Value	0,3519834	0,1736794	0,1966569	0,1336172	0,2293734	0,1580260
Li-McLeod <sup>2</sup> (50)	189,953	169,239	179,024	178,702	182,046	174,706
p-Value	0,6466843	0,9316162	0,8294737	0,8338272	0,7854014	0,8821979
<b>Panel C: Information Criteria</b>						
Akaike	0,006030	0,005862	0,005801	0,005668	0,005652	0,005522
Schwarz	0,041219	0,041052	0,040991	0,040858	0,040842	0,040712

Notes: Panel A shows the results of the conditional correlation driving process  $Q_t$  (Equation 5), the degrees of freedom and the log-likelihood (Equation 7). Panel B demonstrates the diagnostic tests of Hosking (1980) and McLeod and Li (1983). In Panel C we see the information criteria of GARCH(1,1)-cDCC model. The symmetric positive definite matrix  $Q_t$  is generated using one lag of  $Q$  and of  $u^*$ . P-values have been corrected by 2 degrees of freedom for Hosking<sup>2</sup> (50) and Li-McLeod<sup>2</sup> (50) statistics. \*\* and \*\*\* denote statistical significance at the 5% and 1% levels, respectively.

**FIGURE 2**  
 CONDITIONAL VARIANCES OF THE UNIVARIATE GARCH(1,1) MODEL

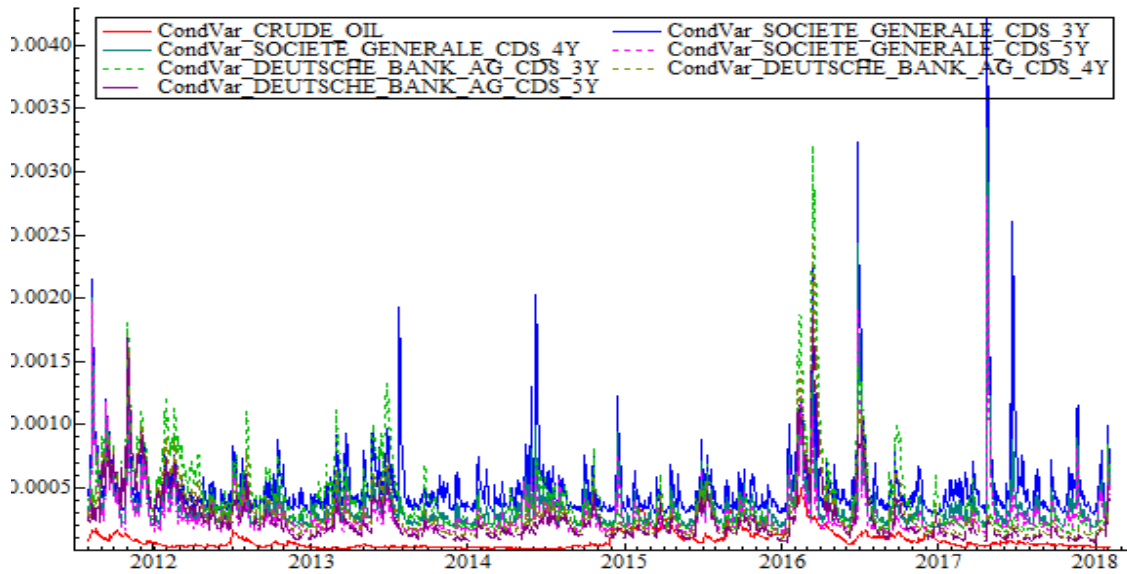

Notes: The red lines represent the conditional variance ( $h_t$ ) for all markets, generated by Equation 3.

**FIGURE 3**  
 CONDITIONAL COVARIANCES OF THE GARCH(1,1)-CDCC MODEL

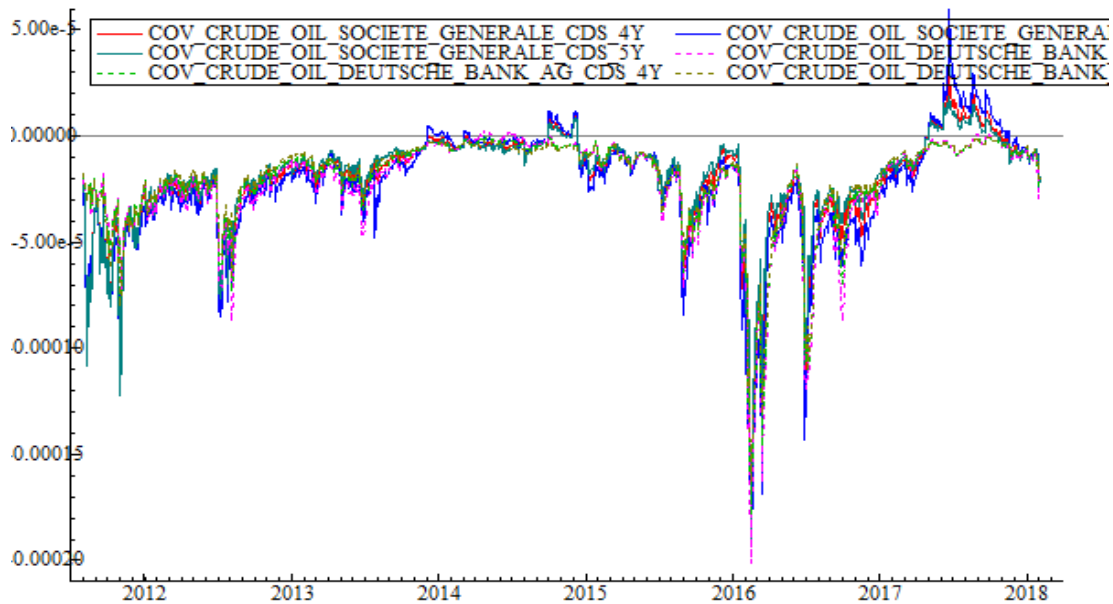

Notes: The red lines represent the conditional covariances of the multivariate conditional variance matrix ( $H_t$ ) (Equation 3) for all the pairs of markets.

### 5.2 Dynamic conditional correlations (DCCs) analysis

The DCCs for the pairs of markets Societe Generale CDS 3Y-Crude oil futures, Societe Generale CDS 4Y-Crude oil futures and Societe Generale CDS 5Y-Crude oil futures demonstrate strong co-movements are graphed in figure 4 below. In addition, they are present common positive values and they are extremely volatile in two periods (from October 2014 to December 2014, from April 2017 to November 2017), suggesting contagion and risky correlations for any investor. DCCs present some common extreme jumps for various reasons, i.e. (a) the President of the Catalonia announcement for a referendum on independence on 9/11/2014 from Spain (14/10/2014), (b) Black Monday (24/08/2015), and (c) when Standard & Poor's credit rating agency downgraded the credit rating of the USA (from AAA to AA+) (5th August 2011), among others.

Next, the DCCs for the pairs of markets Deutsche Bank AG CDS 3Y -Crude oil futures, Deutsche Bank AG CDS 4Y -Crude oil futures and Deutsche Bank AG CDS 5Y -Crude oil futures present strong co-movements. Furthermore, we do not find strong evidence to support the existence of contagion effects. Additionally, DCCs show common extreme jumps due to major reasons, i.e. (a) the European Central Bank announcement of an aggressive money-creation program, printing more than one trillion new euros (22/01/2015), (b) the United Kingdom referendum (23/06/2016), and (c) when Standard & Poor's credit rating agency downgraded the credit rating of the USA (from AAA to AA+) (5th August 2011), among others.

**FIGURE 4**  
DYNAMIC CONDITIONAL CORRELATIONS OF THE GARCH(1,1)-CDCC MODEL



Notes: The red lines illustrate the dynamic conditional correlations ( $R_t$ ) for all the pairs of markets.

## 6. Conclusions

This paper investigates the impact of crude oil future contracts on 3-year, 4-year and 5-year maturity CDSs from Societe Generale and Deutsche Bank AG. Specifically, we quantify volatility transmission by employing a bivariate cDCC-GARCH model. The under investigation period is from 2011 until 2018. To the best of our knowledge, this is the first empirical study, investigating volatility spillover effects between crude oil future contracts and private CDSs of Societe Generale and Deutsche Bank AG.

We find interesting results. According to the descriptive statistics, Société Générale CDS 3Y presents the largest fluctuations compared to the rest markets. Next, we estimate the Jarque-Bera statistic. Results suggest that the daily returns are not distributed normally for all markets. In addition, we employ cDCC- GARCH(1,1) model. Results indicate strong evidence of volatility spillover effects. DCCs analysis state evidence of common contagion effects for the pairs of markets Societe Generale CDS 3Y-Crude oil futures, Societe Generale CDS 4Y-Crude oil futures and Societe Generale CDS 5Y-Crude oil futures during two periods: 10/2014-12/2014 and 04/2017-11/2017.

## References

- Aielli, G. P. (2009). Dynamic conditional correlations: on properties and estimation, *Department of Statistics, University of Florence*. Technical report.
- Belke A. and Gokus, C. (2011). Volatility Patterns of CDS, Bond and Stock Markets before and during the Financial Crisis Evidence from Major Financial Institutions. *Deutsches Institut für Wirtschaftsforschung*. Working Paper.
- Bollerslev, T. (1986). Generalized autoregressive conditional heteroscedasticity. *Journal of Econometrics* 31: 307-327.
- Dickey, D. A. and Fuller, W. A. (1979). Distribution of the Estimators for Autoregressive Time Series with a Unit Root. *Journal of the American Statistical Association* 74: 427-431.
- Driesprong, G., Jacobsen, B. and Maat, B. (2008). Striking oil: Another puzzle? *Journal of Financial Economics* 89: 307-327.
- Engle, R. F. (2002). Dynamic conditional correlation: a simple class of multivariate generalized autoregressive conditional heteroskedasticity models. *Journal of Business and Economic Statistics* 20: 339-350.
- Ewing, B. T. and Malik, F. (2005). Re-examining the asymmetric predictability of conditional variances: The role of sudden changes in variance. *Journal of Banking and Finance* 29: 2655-2673.
- Fonseca, J. D. and Gottschalk, K. (2012). The Co-movement of Credit Default Swap Spreads, Stock Market Returns and Volatilities: Evidence from Asia-Pacific Markets. Working Paper, May 31.
- Geman, H. and Kharoubi, C. (2008). WTI crude oil futures in portfolio diversification: The time-to-maturity effect, *Journal of Banking and Finance* 32, 2553-2559.
- Guo, H. and Kliesen, K. L. (2005). Oil price volatility and U.S. macroeconomic activity. *Federal Reserve Bank of St. Louis Review* 87: 669-684.
- Haigh, M. S. and Holt, M. T. (2002). Crack spread hedging: Accounting for time-varying volatility spillovers in the energy futures markets. *Journal of Applied Econometrics* 17: 269-289.
- Hosking, J. R. M. (1980). The multivariate portmanteau statistic. *Journal of the American Statistical Association* 75: 602-608.
- Lake, A. and Apergis, N. (2009). Credit default swaps and stock prices: Further evidence within and across markets from mean and volatility transmission with a MVGARCH-M model and newer data. University of Piraeus.
- Malik, F. and Hammoudeh, S. (2007). Shock and volatility transmission in the oil, US and gulf equity markets. *International Review of Economics and Finance* 16: 357-368.
- McLeod, A.J. and W.K. Li (1983). Diagnostic checking ARMA time series models using squaredresidual autocorrelations. *Journal of Time Series Analysis* 4: 269-273.
- Tokat, H. A. (2013). Understanding volatility transmission mechanism among the cds markets: Europe & North America versus Brazil & Turkey, *Economia Aplicada* 17.

Wu, F., Guan, Z. and Myers, R. J. (2011). Volatility spillover effects and cross hedging in corn and crude oil futures. *Journal of Futures Markets* 31: 1052–1075.

## Appendices

### APPENDIX A

ACTUAL SERIES OF MARKETS AND THEIR RESPECTIVE LOGARITHMIC RETURNS

**Graph A. Crude oil futures**

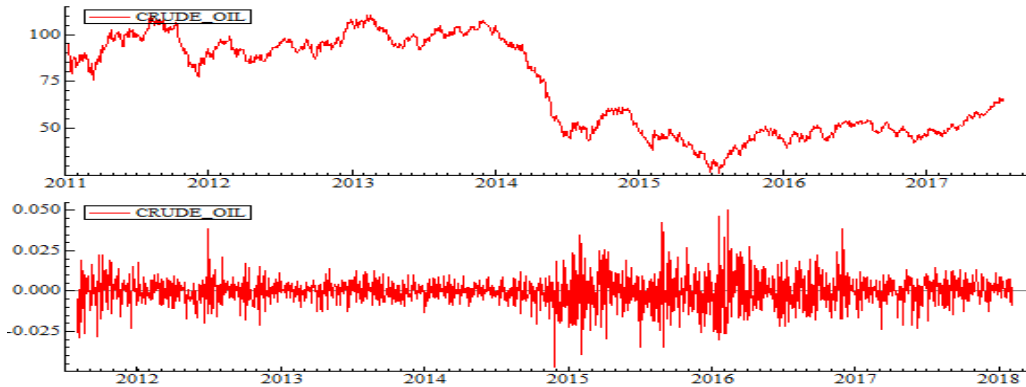

**Graph B. Societe Generale CDS 3Y**

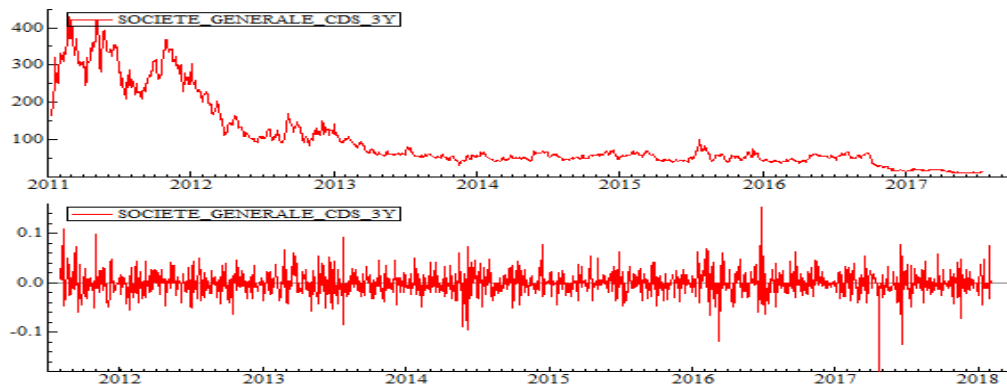

**Graph C. Societe Generale CDS 4Y**

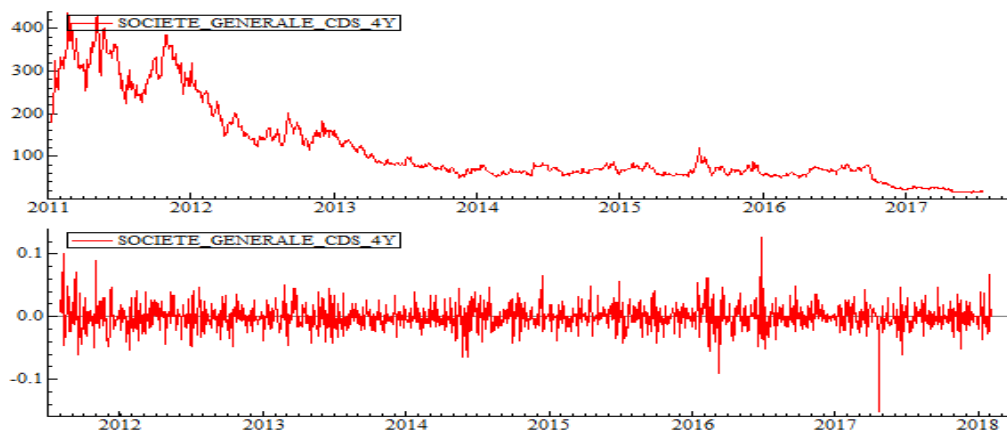



**Graph D. Societe Generale CDS 5Y**

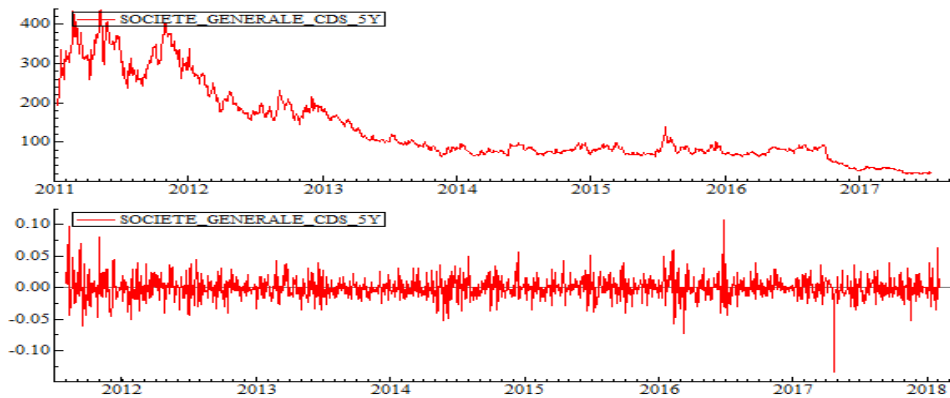

**Graph E. Deutsche Bank AG CDS 3Y**

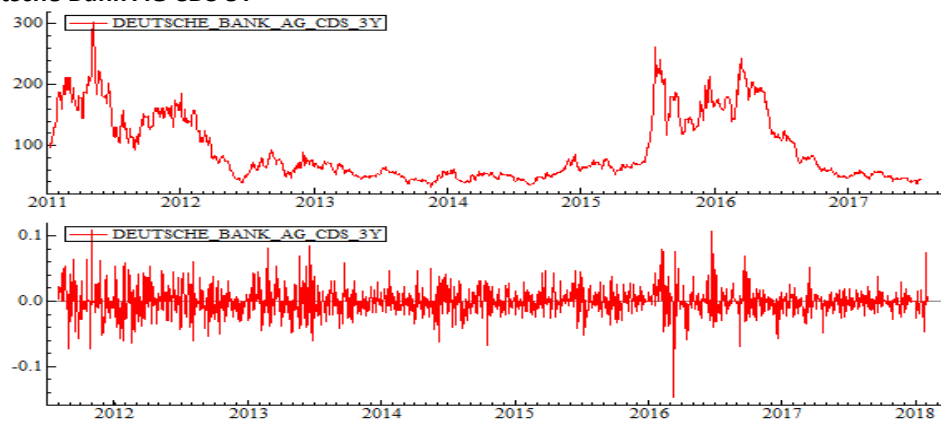

**Graph F. Deutsche Bank AG CDS 4Y**

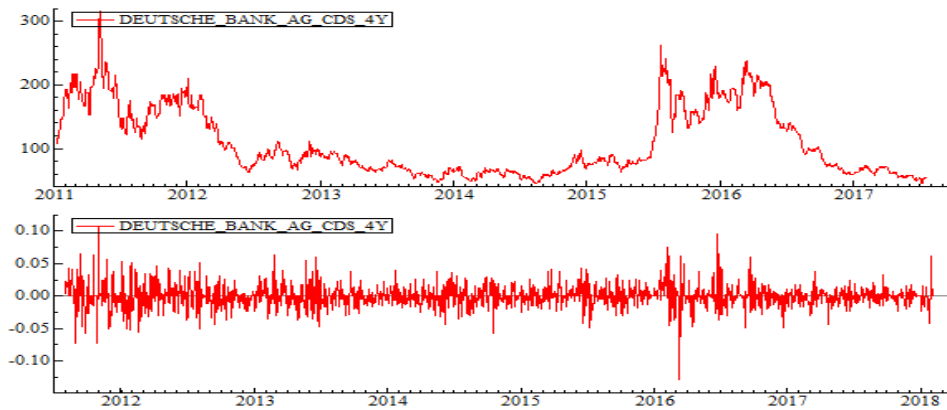

**Graph G. Deutsche Bank AG CDS 5Y**

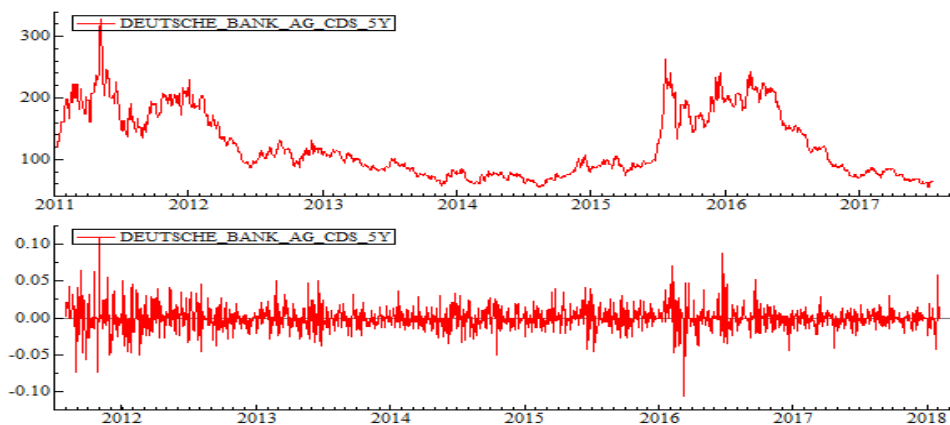

Notes: We calculate the market returns using the equation:  $r_t = \log(p_t) - \log(p_{t-1})$ .

**TOPIC 8: ISSUES OF EDUCATION POLICY AND SOCIAL COHESION**

## 8.1. At the Dawn of the Fourth Industrial Revolution: Challenges and Opportunities of Artificial Intelligence in Education with the view at achieving the Sustainable Development Goals

*Pavlos Petidis<sup>1</sup>*

### Abstract

Artificial Intelligence (AI), in the core of which lies the concept of the excessive use of digital technologies and algorithms, constitutes one of the engines that drive the Fourth Industrial Revolution. As rapid advances in machine learning (ML) algorithms increase the breadth, scope and scale of AI's deployment across all aspects of daily life, leaders and policy-makers acknowledge the importance of incorporating AI technology in the field of education aiming at improving educational equity and quality. Purpose of this paper is to examine the prospective impact of Artificial Technologies to the study process through new teaching and learning methods, to identify the possibility of emerging opportunities in the educational landscape and to propose viable policies so as to pave the way for sustainable use of AI.

The first section of this paper analyses the nature of AI and how can be used to improve learning outcomes on the basis of educational content, innovative teaching methods, technology enhanced assessment and communication between student and lecturer. Pertaining to learning outcomes, concrete examples from countries such as China, Brazil and South Africa are examined on access to education and teacher support. The second section explores the different means by which governments and educational institutions are rethinking and reworking educational programs while in the last section we address, on the one hand, the policy implications that should be part of the global and local conversations regarding the possibilities and risks of introducing AI in education and preparing students for an AI-powered context and, on the other hand, the development of a new curriculum for a digital and AI powered world while focusing on strengthening AI capacities through post-basic education and training.

**Keywords:** Artificial Intelligence, Education, algorithms

### Introduction

In this age of massive information, we tend to leave behind individual data footprints, resulting in an abundance of data, permitting human and social group to be objectively quantified and, therefore, half-tracked, modelled and, to a definite extent, predicted. This development, encompassing data footprints is named as datafication (Mayer-Schonberg & Cukier, 2014) and conjointly affects the education sector. While datafication certainly raises some moral issues (Floridi & Taddeo, 2016), that also need a cooperative policy response, it also brings a world of prospects in terms of individualizing learning and education governance. To date, very little has been mentioned regarding the probabilities and limitations of AI in education within the developing world, significantly concerning the intense issues of the least developed countries. With a view to helping bridge this gap, this paper can discuss AI technologies that education systems worldwide are beginning to use and also explore how they have helped or can help improve learning outcomes.

Since its 'birth' at the 1956 Dartmouth Conference, the field of artificial intelligence (AI) has continued garnering the interest of a and industries alike (Haugeland, 1989). Few technological developments in recent

---

<sup>1</sup> Undergraduate Student, Department of Political Science and Public Administration, National and Kapodistrian University, Greece

history are as polarizing as AI. While AI has been around for nearly 60 years, it nevertheless remained a fringe technology until only recently because of sweeping changes in recent years (referred to as “the big leap”), entailing the abundance of data (big data), economic access to computing power and advances in Machine Learning (Azoulay, 2018). The present paper uses terms such as AI and Big Data, the two main technology buzzwords of the current decade, and other concepts such as machine learning, learning analytics, etc. as technologies that work well together.

It should be borne in mind that these terms are sometimes used interchangeably in the news and articles, thus creating confusion. With a view to avoiding such confusion, this subsection contains a brief explanation of these concepts, clarifying their differences and how they work together.

## **Artificial Intelligence**

### **Background Information**

Thanks to the advent of faster computer processors, the availability of large amounts of big data and advances in computational approaches (Hilbert, 2015), AI has entered a period of renaissance with the aim at becoming integral, pervasive, and inescapable, although often hidden, part of our daily lives. AI is one of those aspects of modern life about which most of us have some awareness, and yet recognize we have little knowledge. In fact, for many AI is synonymous with humanoid robots, which might be because news about AI is almost always illustrated with a picture of a robot or a digital brain (Azoulay, 2018). However, while robotics is a core area of AI research, AI is being applied in many different ways and different contexts.

Instead of using the very name “artificial intelligence”, which is sometimes seen as unhelpful, some researchers make use of the term “augmented intelligence”, which retains the human brain as the source of intelligence, and displays the computer and its programs as a sophisticated tool with which humans might enhance or augment their intellectual capabilities (Mayer-Schönberger & Cukier, 2014). In this approach, computers are employed to do what humans find more difficult such as finding patterns in huge amounts of data. Accordingly, hereafter we will take the ultimate pragmatic approach and refer almost exclusively to AI, leaving the reader to decide for themselves what the A in AI represents.

Many recent developments in AI are both groundbreaking and in many ways transformative. Relatively recent AI computational approaches, such as machine learning (Bali, 2017), neural networks and evolutionary algorithms have all been used in a diverse range of applications. Some key and closely interlinked AI techniques and terminologies will next be introduced.

### **Algorithms**

Algorithms are at the core of AI, such that the history of AI might be considered as the history of the growth of progressively sophisticated and increasingly efficient algorithms. Probably the most popular algorithm of recent times is PageRank, which was devised in 1996 by the founders of Google while they were students at Stanford University. It rates the relative importance of a website, by counting the number of external links to

the website's pages, to determine where the website appeared in a Google search. In fact, all computer programs are algorithms. They consist of hundreds if not thousands of lines of code, representing sets of mathematical instructions that the computer follows in order to solve problems such as compute a numerical calculation, grammar-check an essay, process an image, or explain patterns that we see in nature (European Commission, 2016). All that makes AI algorithms distinct from other computer programs is that they contain some concrete approaches and they are applied to areas we might consider as essentially human (Manyika et al. 2011) such as visual perception, speech recognition, decision-making and learning.

### **Machine Learning**

In 1959, Arthur Samuel coined the term machine learning, only a few years after AI's birth, defining the concept as "the ability to learn without being explicitly programmed". Machine learning algorithms analyze the data to identify patterns and to build a model which is then used to predict future values - for example, by identifying patterns in photographs of named people, it predicts who is shown in other photographs. In other words, machine learning may be considered a three-step process: analyze data, build a model, and undertake an action (Mayer-Schönberger & Cukier, 2014). Instead of the algorithms being programmed exactly what to do, broadly speaking they have the ability to learn what to do. This is not to suggest that machine learning does not require large amounts of programming, because it does. But rather that, machine learning involves large amounts of input data to predict novel outcomes.

Over the last decade, the renaissance and exponential development of AI arose from the significant advances in machine learning, the availability of large amounts of big data. There are three main categories of machine learning: supervised, unsupervised, and reinforcement learning.

### **Supervised Learning**

Most practical machine learning entails supervised learning. The AI is first provided large amounts of data for which the output is already known—in other words, data that has already been labeled (Custer et al. 2018). The supervised learning algorithm intends to determine the function that links the data to the labels, from which it constructs a model that can be applied to new similar data. This is broadly speaking the approach used by Facebook to identify people, which used millions of photographs submitted and labeled by Facebook users to identify and label automatically the same people in new photographs.

### **Unsupervised Learning**

In unsupervised learning, the AI is provided with even larger amounts of data, but this time data that has not been categorized or classified, that is to say data that is not labeled (Bali, 2017). By examining this unlabeled data, unsupervised learning algorithms attempt to reveal hidden patterns in the underlying structure of the data, clusters of data that can be used to classify new data (Nye, 2015). Significant example applications of unsupervised learning include dividing online shoppers into groups so they can be served tightly targeted advertisements or distinguishing between legitimate and fraudulent financial transactions (Williamson, 2015).

## Reinforcement Learning

While in both supervised and unsupervised learning the model stemmed from the data is fixed and if the data changes the analysis has to be undertaken again, reinforcement learning encompasses continuously improving the model based on feedback—in other words, this is machine learning in the sense that the learning is ongoing. The AI is provided with some initial data from which it derives its model, which is evaluated, assessed as correct or incorrect, and rewarded or punished accordingly (Samuel, 1959). The AI uses this positive or negative reinforcement to update its model and then it tries again, thus developing iteratively (learning and evolving) over time. For example, if an autonomous car avoids a collision, the model that enabled it to do so is rewarded (reinforced), enhancing its ability to avoid collisions in the future.

## Artificial Neural Networks

An artificial neural network constitutes an AI algorithm that is founded on the structure and functions of biological neural networks (i.e. animal brains), that might be implemented in advanced supervised, unsupervised, or reinforcement learning. Although artificial neural networks have been equipped with the ability to do some incredible things (such as identifying faces in moving crowds of people), they remain primitive in comparison to higher-order animal brains.

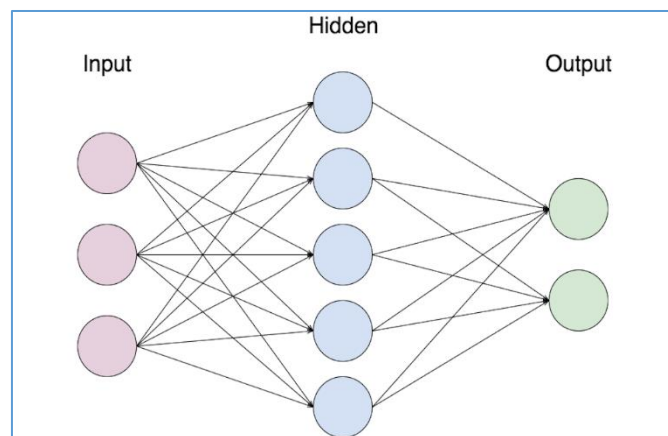

As depicted in the figure, artificial neural networks each comprise three types of layers: **an input layer** that takes stimuli from the environment, in the form of millions of data points, perhaps pixels from images (Gurney, 1997). The second layer can be found at least one, but often many more, hidden intermediary layers that together undertake the computation (Hertz et al. 1991) and an output layer that delivers the result (Hertz et al. 1991). During the machine learning process, weightings given to the connections are adjusted in a process of reinforcement learning, which allows the artificial neural network subsequently to compute outputs for new stimuli (Hertz et al. 1991).

The hidden layers, despite being the key to the power of artificial neural networks, also bring an important problem. It isn't possible to interrogate an artificial neural network to find out how it came up with its solution—for example, how did it identify a particular person in a photograph? In other words, artificial neural

networks can lead to decision making for which the rationale is hidden and unknowable, or uninspectable, and possibly unjust, a critical issue that is the subject of much research.

### **Deep Learning, Data mining and Learning Analytics**

Among the most widely used terms to describe the many approaches to machine learning, deep learning, data mining and learning analytics stand out. Regarding deep learning, it is a specific subfield of machine learning, thus a new take on learning representations from data that puts an emphasis on learning successive layers of increasingly meaningful representations. In deep learning, these layered representations are (nearly always) learned via models called neural networks structured in literal layers stacked on top of each other. As far as data mining is concerned, it is the process of discovering interesting and useful patterns and relationships in large volumes of data (Williamson, 2015). Educational Data Mining (EDM) develops methods and applies techniques from statistics, machine learning and data mining to delve into data collected during teaching and learning.

As an emerging discipline, learning analytics (LA) seek to apply different areas of knowledge such as sociology, psychology, ethics, and pedagogy so as to improve teaching and learning by critically evaluating raw data and generating patterns to characterize learner habits, predict learner responses and provide timely feedback (Bali, 2017). Moreover, by collecting a lot of data that can be analyzed, LA supports decision-making by extracting insights or even develop helpful smart tools for educational or administrative tasks (Custer et al. 2018). Analyzing and getting the most out of data is no easy task. Analysis is also a very important step in developing future AI solutions that, with the help of powerful libraries, including yet not limited to natural language recognition, language translation and game theory, will enable us to, for instance, create avatars that simulate the behavior of a virtual teacher for students or an assistant for teachers. The bright prospects of the future allow us to visualize an AI ecosystem that can help us overcome the different challenges in learning analytics.

### **ARTIFICIAL INTELLIGENCE AND EDUCATION**

Since its very outset, AI in education has nevertheless faced many difficulties to grow because education systems around the world are more reluctant to technological changes in their traditional organization. AI was part of the vision promising to transform education by creating tutor systems that could personalize learning (Clancey, 1987). This promise is starting to unfold as present technology has begun experimenting with different models worldwide, bringing many questions to the field of education (Woolf et al. 2013). Having established a working understanding of AI, we will now look in more detail at how AI works in educational contexts, beginning with a brief history. However, what will not be discussed is the use of AI to support school administration such as system-facing AI that addresses things like class timetabling, staff scheduling, facilities management, finances, cybersecurity, safety and security (US. Department of Education, Office of Educational Technology, 2012). Our focus is the use of AI to support learning (student- and teacher-facing AI) (Roll & Wylie, 2016).

## **A Brief History of AI in Education**

Precursors of the application of AI in education can be found in the work of the psychologists Sidney Pressey, a professor at Ohio State University in the 1920s, and B. F. Skinner, known as the father of behaviorism.

### **Sidney Pressey's Teaching Machine**

By rejecting a view of learning as an accumulation of responses governed by environmental stimuli in favor of one governed by meaning, intention and purpose, Pressey's vision stemmed from its firm belief that, in addition to supporting learning, a teaching machine could make a teacher's life easier and more fulfilling by relieving them of one of their least interesting tasks (marking tests) and giving them more time to engage with their students. In particular, the idea of a teaching machine started as an answer to a challenge. In the core of this challenge lies the need to leverage the potential of multiple-choice tests so as to consolidate student learning as well as to evaluate it (Pressey, 1933).

Inside Pressey's mechanical typewriter was placed a rotating drum around which was wrapped a card printed with a list of questions and hole-punched to represent the correct answers. Meanwhile, the machine had a window which showed the number of the current questions and five typewriter keys, one for each possible answer. As the student worked through a printed sheet of questions and answers, they would press one of the keys to choose their answer for each question. The machine recorded the answer on a counter to the back of the machine and showed the next question. The machine was configured so that the student immediately knew whether they had made the right choice, and it prevented them from moving onto the next question until they had.

Drawing on Edward Thorndike's law of effect (Thorndike, 1911), he contended that, for tests to support learning, immediate feedback was a prerequisite—which is not usually possible when tests are marked by hand. For that reason, the great idea behind Pressey's teaching machine was to fix the machine so that it would not move on until the student chose the right answer. Then it was easy to show that this second arrangement taught the students which were the right answers. This was the first demonstration that a machine could teach and also a demonstration that knowledge of results was the cause of the learning (Pressey & Janney, 1937). This kind of feedback to the learner is basic: it just tells the learner whether they are right or not.

### **B. F. Skinner: Behaviorism in practice**

Pressey's approach was later extended by Skinner, who asserted that the techniques he developed for training rats and pigeons might be adjusted to teaching people. Skinner's teaching machine, which he devised in 1958, was a wooden box with a windowed lid. Questions written on paper disks appeared in one window, and the student wrote a response on a roll of paper accessible through a second window (Skinner, 1936). Advancing the mechanism automatically incorporated the student's answer, so that it could not be altered and simultaneously disclosed the correct answer. In this way, Skinner's teaching machine offered automatic, immediate reinforcement. Students were required to compose their own answers, rather than decide from a



limited selection (as with Pressey's multiple-choice questions), because Skinner found that learning is more effectively reinforced by remembering a correct response than by simply recognizing it. This course of action also gave the student the opportunity to juxtapose their answer with the given model answer, which if properly contrived by the teacher and actively undertaken by the student could also contribute to learning (MacCorquodale, 1970).

Skinner claimed that his teaching machine in effect acted like a personal tutor, foretelling the emergence of AIED's intelligent tutoring systems. Skinner's teaching machine might be thought to have also foreshadowed something else later taken up by AI in education researchers, breaking up automated teaching into separate components. Specifically, in Skinner's case, the subject content, which was pre-programmed into the machine was distinguished by the student's achievements, whether or not they answered a question correctly (Toates, 2009). However, although in a sense Skinner's teaching machine was responsive to individual students, it could not be considered adaptive. That is to say, it did not adapt either the questions, or the order in which they were presented, according to the achievements or needs of the individual students (Nye, 1979). Instead, question delivery was pre-scripted. While a student could proceed at their own pace, they went through the same list of questions as every other student and in the same order.

### **SAKI: The First adaptive teaching machine**

The British polymath, Gordon Pask, constructed the first truly adaptive teaching machine in the early 1950s. Known as SAKI (the self-adaptive keyboard instructor), it was created for trainee keyboard operators studying how to use a device that punched holes in cards for data processing. What differentiated SAKI from the other early teaching machines was that the task presented to a learner was accustomed to its learner's individual performance, which was represented in a continuously changing probabilistic student model. SAKI went through many duplications, taking advantage of developments in computers and the new microprocessors.

However, over the following years, adaptive learning made limited advances, and the focus moved to what became known as **Computer-Aided Instruction (CAI) systems**. The 1960s and 1970s saw many CAI systems being built, an early influential example being PLATO, which was developed at the University of Illinois. PLATO, grounded in a programmed logic for automatic teaching operations, comprised students using standard teaching materials, some of which were interactive, on a central mainframe computer via remote terminals, with as many as a thousand students working at the same time (Nye, 2015).

This system was also notable for being the first to familiarize the world with a wide spectrum of tools and approaches still common today, such as user forums, email, instant messaging, and remote screen-sharing, and multiplayer games (Clancey, 1987). Around the same time, Stanford University and IBM developed a computer-aided instruction system that was made available via remote terminals to a few local elementary schools. This system involved a linear presentation of teaching materials, for mathematics and language arts, together with drill and practice activities (Custer et al. 2018). Although in other ways successful, during the 1960s and 1970s only very few of these CAI systems were widely embraced, mainly owing to the cost and

accessibility of the university mainframes that were needed to host the software. Nonetheless, the majority of these systems were severely impeded by the same weakness – a significant lack of adaptability.

At around the same time that mainstream CAI was building up, other researchers, such as John Self and William Clancey, were considering potential applications of CAI adaptive to the needs of individual students. The first implementation of AI techniques in computer-aided instruction is attributed to Jaime Carbonell, who, in his 1970 PhD thesis, introduced a system called SCHOLAR. This novel system was capable of producing individual responses to student statements by drawing from a semantic network - a way of representing knowledge, in this case knowledge of geography, in which concepts are linked according to their semantic relationships.

## **APPLICATION OF AI IN EDUCATION**

So-called intelligent tutoring systems (ITS) are among the most common applications of Artificial Intelligence in the education sector. In a general stance, ITS offer step by-step tutorials, personalized for each student, via topics in well-defined structured subjects such as mathematics or physics (Clancey, 1987). By making use of expert knowledge regarding the subject and about pedagogy, and in response to individual student's misinterpretations and successes, the system defines an optimal step-by-step pathway across the learning materials and activities. As the student continues, the system automatically adjusts the level of difficulty and provides hints or guidance, all of which aim to make sure that the student has the ability to absorb the given topic effectively (Baker, 2016).

ITS come in many shapes, although typically they entail several AI models, an approach that we will unwrap here. The models used by ITS embody knowledge specific to teaching and learning. Typically, knowledge about the topic to be learned is represented in what is described as **a domain model**, knowledge about effective approaches to teaching is represented in **a pedagogical model**, and knowledge about the student is represented in **a learner model** (Ohlsson, 1992). The ITS algorithm draws on these three models in order to adapt a sequence of learning activities for each individual student.

### **The Domain Model**

A domain model represents knowledge about the subject that the ITS aims to help the students learn (much like the subject knowledge in a standard, non-educational, expert system). This might, for example, be knowledge about mathematical procedures, genetic inheritance, or the causes of World War I. In fact, over the years, mathematics for primary and secondary school students has dominated ITS. Mathematics, along with physics and computer science, are AIED's low-hanging fruits because they are, at least at a basic level, well-structured and clearly defined.

### **The Pedagogy Model**

The ITS pedagogy model represents knowledge about effective approaches to teaching and learning that have been elicited from teaching experts and from research in the learning sciences. Pedagogical knowledge that

has been represented in many ITS include knowledge of instructional approaches, 87 the zone of proximal development, 88 interleaved practice, 89 cognitive load, 90 and formative feedback. 91 For example, a pedagogical model that implements Vygotsky's zone of proximal development will ensure that activities provided by the system to the student are neither too easy nor too challenging, one that implements individualized formative feedback will ensure that feedback is provided to the student whenever it might support the student's learning.

### **The Learner Model**

As we have seen, some CAI effectively (although usually by another name) implemented versions of both domain and pedagogical models: knowledge of what was to be learned and knowledge of how to teach what was to be learned (for example, using linear or branching programmed instruction). However, what distinguishes AI-driven ITSs is that, as foreshadowed by Pask's SAKI, they also include a learner model: "a representation of the hypothesized knowledge state of the student." 92 In fact, many ITS incorporate a wide range of knowledge about the student—such as their interactions, material that has challenged the student, their misconceptions, and their emotional states while using the system—all of which can be used to inform what is being taught and how, together with what support needs to be provided and when.

In fact, most ITSs go much further. The knowledge stored about the individual student is augmented with knowledge of all the students who have used the system so far, from which the system machine learns in order to predict which pedagogical approach and which domain knowledge is appropriate for any particular student at any specific stage of their learning. It is the learner model that enables ITS to be adaptive, and the machine learning that makes this adaptivity especially powerful.

## **THE PATH TO ACHIEVE SUSTAINABLE DEVELOPMENT GOAL 4 (QUALITY EDUCATION): CHALLENGES AND OPPORTUNITIES FOR ARTIFICIAL INTELLIGENCE**

### **Theoretical Background**

As inherently complex, the Sustainable Development Goals were adopted by all United Nations Member States in 2015 as a universal call to action to end poverty, protect the planet and ensure that all people enjoy peace and prosperity by 2030 (U.S. Department of Education, Office of Educational Technology, 2012). They also offer a global platform for collaboration across subject matters (climate, water, poverty, etc.), sectors (private, civil society, government, etc.), and industries (finance, healthcare, food, etc.) to understand and solve.

What must be given emphasis in is that the 17 SDGs are integrated (Woolf et al. 2013)—that is, they recognize that action in one area will affect outcomes in others, and that development must balance social, economic and environmental sustainability. Academic institutions, especially those that encourage interdisciplinary working, are effective platforms for this type of approach. In that essence, the Sussex Sustainability Research Programme convened a workshop with diverse experts and stakeholders so as to examine how targeting efforts around the interactions between the SDGs, whether synergies or trade-offs, will be critical for driving progress

forward (Williamson, 2015). In addition, Sussex researchers emphasized the various forms of AI – machine learning, natural language processing, predictive analytics, and more – as the driving force for great efficiencies, speed, and intelligence to tasks and processes.

They noted that the wide array of capabilities that the AI sector has – including automating routine tasks, analyzing big data, and bringing intelligence and learning to various processes – proves the enormous potential AI technologies possess to address the imminent sustainable development issues. In combination with other technologies (e.g. sensors), tools (e.g. data analytics), and infrastructure (e.g. data centers), AI enables us, they claimed, to access, analyze, and act on ever-growing sets of data (European Commission, 2018). To establish an effective AI approach for the achievement of the targets, they emphasized on the following elements as the key features based on an interdisciplinary thinking

“SDG-related problems must be articulated and rephrased such that they can be solved by AI, for example drought can be rephrased as a problem of water management;”

“Experts from different areas should agree a shared language and understanding of research opportunities;”

“Steps should be taken to ensure that AI is applied appropriately in specific contexts;”

“Provide robust interpretations of research results, built on an understanding of the technology as well as the challenge, area or context in which it is applied.”

The researchers also suggested it may be possible to identify appropriate data and build AI models that improve our understanding of the interconnections between the SDGs and their 169 targets, whether they are synergies or trade-offs. To illustrate, a billion people globally do not have access to electricity in their homes, and three billion rely on dirty fuels such as charcoal and animal waste for cooking. This lack of access to clean energy (Goal 7) has negative impacts on education (Goal 4), economic status (Goals 1 and 10), and gender equality (Goal 5). In specific contexts such as this, the researchers suggested it may be possible to use AI to improve our ability to understand and prioritize our efforts, ultimately helping to accelerate progress towards the SDGs.

## **Opportunities**

This first section focuses on the ways in which AI could be used to improve learning and equity in education under the context of the Sustainable Development Goal 4. The section addresses two main topics: one dedicated to improving personalization through AI (pedagogical scale) and the other focused on education management information systems (systemic management scale).

### **Personalization and Better learning outcomes**

Different studies (Laanpere et al., 2014; Luckin et al., 2016; Mayer-Schönberger & Cukier, 2014; Montebello, 2017) have recently contributed to the ways in which AI can help harness learning opportunities for students and management systems. Sustainable Development Goal 4 aims to ensure inclusive and equitable quality education and promote lifelong learning opportunities for all. It emphasizes equal learning opportunities for

all throughout life (UNESCO, 2018). In light of the existing initiatives and technologies to come, AI technologies are used to guarantee equitable and inclusive access to education. Teachers spend plenty of time on routine and administrative tasks such as making assignments and answering frequently asked questions over and over again in school settings. A dual-teacher model entailing a teacher and a virtual teaching assistant, which can take over the teacher's routine task, frees up teachers' time, enabling them to focus on student guidance and one-to-one communication. AI can help establish a better professional environment for teachers to work more on students with difficulties. To that effect, teachers have already started working together with AI assistants for the best outcomes for their learners.

The Computer Assisted Learning (CAL) field creates alternative paths to underpin students' learning strategies with digital and AI technology (Azoulay, 2018). AI can outline each student's individual learning plans and trajectories, their strengths and weaknesses, subjects that cost more and are easily assimilated or learned, and learning preferences and activities (Luckin et al. 2016). Using algorithms to help students navigate through different content paths, AI can personalize learning and upgrade the opportunities for students with the help of their teachers and schools. Intelligent Tutoring Systems are part of the new technological possibilities to expand educational learning in developing countries as shown in recent reviews (Nye, 2015).

### **Case Study**

With 730 million internet users in 2016, the government proposed and launched a plan to become the largest pole of AI development in the world by 2030. China set its national AI strategy for education as part of this technological vision (Jing, 2018) by relying on the private sector. For example, Huijiang, a private digital education company, is developing image and voice recognition software capable of understanding student facial expressions to give AI feedback online. Liulishuo is an adaptive platform that teaches English to 600,000 students at the cost of a single teacher. In addition, China's Ministry of Education established that every educational branch of local governments must allocate at least 8% of its budget to the digitisation of education (Chen, 2018). One of the biggest breakthroughs so far in China is the experimental design to correct essays with AI. The country started to work with 60,000 schools for automatic essay correction with a level of precision matching humans in 92% of the cases. The essay grading machine is based on neural network AI and is enhancing its ability to analyze human language by applying deep learning algorithms to plough through essays written by Chinese students and correlate notes with human teachers' grading and comments (Chen, 2018). "It has evolved continuously and become so complex, we no longer know for sure what it was thinking and how it made a judgment," said one of the project researchers (Chen, 2018).

### **A new curriculum for a digital and AI-powered world**

The concept of "bridging the AI skills gap" does not refer only to the wide adoption of increasingly powerful technologies to facilitate learning but also includes rethinking the content and methods used to deliver instruction at all levels of education. The efforts for a curricular reform have clearly shown a crystal clear need

to define “AI competencies” beyond basic ICT competencies. To approach this topic, we will focus on new frameworks that characterize digital skills for students and teachers.

### **Digital competencies frameworks**

The need to collect data for the SDG 4 Education indicators sets the table for a collective work for the development of a “Global Framework to Measure Digital Literacy”. As one of the main priorities of a task force of experts and country representatives established by the Global Alliance to Monitor Learning (GAML), they provided a main definition of digital literacy - the ability to access, manage, understand, integrate, communicate, evaluate and create information safely and appropriately through digital devices and networked technologies for participation in economic and social life- that includes competencies variously referred to as computer literacy, ICT literacy, information literacy, and media literacy” (Luckin et al. 2016). As a parallel initiative, the Information and Communication Technologies Competency Framework for Teachers (ICT-CFT), developed by UNESCO, underline that it is not enough for teachers to have certain skills to manage digital technologies and to teach them to their students, but also that teachers must help their students be capable of collaborating, solving problems and being creative in the use of digital technologies (UNESCO, 2018). Finally, another framework is “DigComp” (Joint Research Centre, 2018) designed by the European Union to support the development of digital skills of individuals (European Commission, 2018). The framework describes what competencies are needed today to use digital technologies in a critical, reliable, collaborative and creative way, so that individuals can achieve their goals related to work, learning, leisure, inclusion and participation in the digital society.

### **Strengthening AI capacities through post-basic education and training**

The number of countries that have developed a national AI strategy is increasing. France in Europe, China in Asia and lately the United States in North America are examples of the kind of comprehensive strategies that, despite a huge focus on R&D, attribute a major role to the development of an AI-capable workforce (Russel & Norvig, 2010). In all these three cases, most attention is given to higher education but also to technical and vocational education (Luckin et al. 2016). The pressing need to adapt to rapid developments in AI exerts itself on post-compulsory educational institutions as well. Building AI expertise through higher education and research is one of the main approaches used by governments to address their respective skill gaps.

### **Case Study**

China has also devised a Next Generation Artificial Intelligence Plan, which was launched in 2017. This plan sets out a vision for the country to be the world’s centre of AI innovation by 2030 (Government of the People’s Republic of China, 2017). Education and training play a huge part in the realisation of this plan, with the government aiming to accelerate the cultivation of top-tier talent in the field of AI (Government of the People’s Republic of China, 2017). It intends to achieve this by developing AI majors in university, increasing enrolment in master’s and doctorate programs in AI, and integrating AI content in the study of other disciplines

such as mathematics, biology, psychology, sociology and law, among others (Government of the People's Republic of China, 2017). In line with the objectives of this plan, the country launched an International AI Training Programme for Chinese Universities, which began operating at Peking University in 2018 (China Daily, 2018). Through this programme, China aims to train at least 500 teachers and 5,000 students in AI in the country's top universities over the next five years (China Daily, 2018).

### **Technical and Vocational Education and Training (TVET)**

TVET institutions should also be capable of providing programs and courses that integrate AI-related competencies and ensuring that the instructional content of TVET programs are aligned with the needs of the labor market (Woold et al. 2013) and constantly rethought and revisited, given the rapid pace of development in AI technologies. The Unesco Education Sector is also developing initiatives that harness AI to achieve SDG 4, with a particular emphasis on TVET. For example, in partnership with Ericsson, UNESCO's ICT in Education Unit is launching the initiative 'Artificial Intelligence for Youth' that focuses on scaling up AI skill development for young people. This project aims to support and foster the capacities of master trainers to empower youth in developing innovative AI applications.

### **Non-formal and informal learning**

'Schooling' must be separated from 'learning': While schooling takes place within structured learning environments contained within a fixed time and place, learning occurs in a continual fashion, regardless of time and place. With the existence of mobile technologies, for instance, it has even become more apparent that learning can occur well outside the bounds of traditional, brick-and-mortar educational institutions (Woold et al. 2013). Massively open online courses (MOOCs) and online learning platforms such as Khan Academy are alternative channels by which individuals can access training on AI-related skills, with various universities offering online courses on programming, data science and machine learning, for instance. Coursera, edX, Future Learn, Udacity, CognitiveClass.ai, etc. are examples of such platforms which, in some cases, say that they are applying NLP (Natural Language Processing) and Machine Learning in combination with Crowdsourcing, for example, to grade short answers, coding exercises, vocabulary and even automatically generate 'wh' (who/what/when/where/why) questions. There have also been grassroots initiatives such as Code.org and EU Code Week, whose outreach only continues to grow over time (European Commission, 2016).

## **CHALLENGES**

New discussions both in the field of international aid and within national policies are starting to arise. Is education a field in which technology can help leapfrog inequalities? (Woold et al. 2013). How can public policies empower teachers so they are key actors in this process and not mere spectators? Recent systematic reviews show that AI in Education has been a field of research concentrated in developed countries (Roll, I. & Wylie, 2016). This final section aims at bringing the discussion to the main future challenges regarding the

incorporation of AI in education as a way to improve the equity, to achieve quality of learning and to promote the realization of SDG 4.

### **First challenge: a comprehensive public policy on AI for sustainable development**

Education systems are expected to form learners who possess the skills needed to thrive in a society surrounded by AI. Currently, most of the AI developments in education come from the private sector. Companies such as Pearson, McGraw-Hill, IBM, Knewton, Cerego or Coursera are advancing in the introduction of adaptive learning through intelligent algorithms that use Big Data to personalize learning. Most governments are struggling to manage this surge in private sector engagement with AI in education. Recent studies show that the digital education market will increase 5% annually until 2021 (Woolf et al. 2013). Experts forecast a 50% growth in the artificial intelligence market between 2017 and 2021 (Custer et al. 2018). How can AI help learners, teachers, administrators and policymakers? What is the role of the state in this context? Can it cope with the velocity of technological change driven by private markets?

The development of public policies regarding AI in education remain in its infancy, but it is a field that emerges and will most likely grow significantly in the next ten years. Many countries have programmed significant budgetary commitments towards the creation of AI research centers and the recruitment and training of AI professionals (Woolf et al. 2013). Indeed, governments are investing in research and advanced training in AI, which primarily occur at higher education institutions, through the establishment of academic centers of excellence in AI, university and research institute networks and scholarships to attract more talent into the field of AI. Partnerships between universities and research institutes encourage collaborative research, which can accelerate the development of expertise in AI.

### **Second challenge: Ensuring inclusion and equity in AI in education**

While AI can create various possibilities, it can also be a disruptive technology and may intensify the existing inequalities and divides as the marginalized and disadvantaged population are more likely to be kept out from AI-powered education (Woolf et al. 2013). The outcome is a new kind of digital divide: a divide in the use of data-based knowledge to inform intelligent decision-making (Woolf et al. 2013). Equity and inclusion should be accepted as core values when designing policies for AI in education. Policy makers should thus ask several inclusion and equity questions when developing their policies. For instance, what have we learned from previous experiences to build sustainable and equitable conditions to digital rights in terms of internet access? How can AI serve the education provided to disadvantaged groups and populations? How can digital education and AI grow faster in developing countries to close the educational gap between rich and poor students of the world?

Recent studies have mapped the obstacles for introducing AI in education in developing countries. The main ones include ICT hardware availability, electrical availability, Internet reliability, Data costs, Students' basic



ICT skills, Language and Lack of culturally appropriate content (Nye, 2015). Further reviews on the introduction of Big Data show that the lack of basic infrastructures creates a new digital divide in the use of data-based knowledge for informed intelligent decision-making (Hilbert, 2015). To remove these obstacles, it is essential to start by defining the internet as a human right and creating multiple international alliances to build infrastructure in the poorest sectors of the developing world.

### **Third challenge: Preparing teachers for AI-powered education and preparing AI to understand education**

There are no indications of a system-wide adoption of AI-based applications for teaching and learning or system management. Their fundamental flaw stems not from their effort to deal with the existing obstacles and issues that teachers face but on the development of new ways of organizing teaching that oppose with mainstream traditional practices and structural norms (Woolf et al. 2013). Against this context, some countries have already planned policies that aid national EdTech industry's efforts to promote innovation, strengthen efforts and modalities of qualifying and empowering the demand (teachers and schools), while supporting their innovative practices and, finally, deepening how AI can contribute to a richer, more evidence-informed policy and planning environment in education.

Learning analytics platforms can use predictive algorithms to help teachers diagnose and foresee learning difficulties faced by learners and thus implement personalized interventions and instructions to respond to those difficulties. However, the effectiveness of learning analytics systems arises from their usefulness and significance to learners and educators. As such, educators continue to play the primary role. Teachers and head teachers should be ascribed sufficient autonomy to lead their respective classrooms and schools, grounded in the notion that they are most familiar with the needs of their learners.

Teachers will therefore remain at the frontline of education. It is misleading to say that AI can replace teachers. Arguments to the contrary reduce the teaching profession to the performance of solely cognitive and routine tasks, disregard the research that stresses the importance of a human mentor to support the learning process and pay no attention to the creative and socio-emotional aspects of teaching, which go beyond mere knowledge transmission (Bali, 2017). Furthermore, teachers will choose how and when it would be proper to use AI-enabled tools. As such, the development of these AI-enabled tools and their integration into the delivery of educational programs must be a participatory process, designed to “deliver the support that educators need – not the support that technologists or designers think they need” (Luckin et al. 2016). Given the eventual widespread use of AI in the classroom, teacher training is therefore a critical aspect of empowering teachers to use educational data to improve pedagogy.

### **Fourth challenge: Developing quality and inclusive data systems**

Given that data generate AI, complete, reliable and timely data constitute an important prerequisite for installing AI-enhanced data analytics systems. A fully functional data analytics system with comprehensive

and up-to-date data opens possibilities for AI-enabled predictive and machine learning algorithms (Ohlsson, 1992). Data enable intelligent systems. Without the needed data, no sort of algorithm, no matter how sophisticated, can function properly. As such, a data-rich environment is a prerequisite to AI-enabled systems.

However, data availability is a necessary yet insufficient condition. It follows that any AI-enabled system is only as good as the data it contains. After all, inaccurate data are likely to make machine learning algorithms generate incorrect outputs. Indeed, predictive algorithms can only make complete and accurate predictions if the data they are handling are itself complete and accurate. However, many countries still struggle with collecting basic yet critical educational data.

The UNESCO Institute for Statistics (UIS) cites the many hindrances to the efficient and effective collection and use of educational data (UIS, 2018). Educational data should be open and usable at the school level. An EMIS should be able to generate analyses that are granular enough to help teachers and education administrators understand the key challenges while also being able to aggregate data to reveal trends that can inform policy development. Furthermore, data must also account for inequities, providing insights, for example, on learning outcomes disaggregated according to demographic factors such as age, gender and socio-economic background (UNESCO, 2018).

Open data can also be an impetus for data use. The ability to access data and metadata does not only allow intermediaries (e.g. NGOs) and community stakeholders to draw direct value and mine insights from education data, but this transparency also creates a greater sense of accountability on the part of ministries of education for the improvement of educational outcomes (UNESCO, 2018). Open data are anchored on the discourse of data 'prosumption', i.e., stakeholders do not only consume data but are also involved in data production and interpretation (Williamson, 2015). Stakeholders must have access to data analytics if they are to be involved in the improvement of the education system. AI-powered technologies provide opportunities to make educational data more useful at each level of the education system.

Of course, having an adequate amount of data is a prerequisite to producing such analyses. As such, countries with weak or incomplete data systems should focus on strengthening their data systems and bridging their data gaps. It must be acknowledged, however, that while technologies for capturing data are indeed becoming more and more powerful, their costs could be prohibitively high, particularly for low- and middle-income countries. As such, the costs of such data systems need to be carefully examined and weighed against the potential benefits. While numerous governments are able to produce large amounts of education data to inform decision-making, many countries are still unable to do so (Custer et al. 2018).

Many efforts to remedy this problem have fallen short since they focused on the procurement of more sophisticated data reporting technologies, even when the issue lay in weak institutional processes that would result in faulty, incomplete and unused data. This harks back to strong institutional and organizational processes being a prerequisite to the installation of any data-dependent system, including AI technology. As

such, institutional capacity-building becomes a crucial investment, particularly for countries whose data processes remain ad hoc and thus unable to produce consistent, relevant and timely data.

### **Fifth challenge: making research on AI in education significant**

While we can reasonably expect increased research on AI in education in the coming years, it is also worth recalling the difficulties that the education sector has in taking stock of educational research in a significant way for practice and policy-making. The particular domain of research on educational technology clearly demonstrates that what researchers state as key research questions are quite often unrelated to teachers' needs. Technology's potential to transform education has often been stated, though it is widely accepted that, for various reasons, this potential has yet to be harnessed as expected in developed countries (Conlon & Simpson, 2003; Cuban, 2001; OECD, 2015; Sandholtz, 2001) or developing countries (Power et al. 2014).

Research should ascertain the strategies that will make this possible, the conditions in which they would be feasible and, ultimately, capable of being applied widely. The feasibility issue is extremely important for school learning because there may be many strategies that could prove to be incompatible with the current configuration of schools and even the teaching profession. Education research, relating to technology and also in general, is complicated by the very nature of its subject matter and because contextual conditions limit its capacity to provide results from which generalizations can be drawn, thereby affecting its ability to contribute to the creation of universally valid theories. In education, there is an omnipresent problem of these so-called "ubiquitous interactions", i.e. the sheer number of variables that increase the difficulty of isolating impacts or combining the results of different studies (Lederman, 2003). As it is very difficult to isolate the influence of instructional strategies, any example relating to strategies to improve learning would serve student skills and abilities, socioeconomic status, motivation and the interaction between all these variables.

Finally, there is also a need for a localized and decentralised examination of what is taking place in classrooms. Despite that the international agenda for education seems to suggest that AI may bring only benefits, there is an understanding of "local needs in local contexts" in order to find more broad strategies that could be supported by AI, replicated and also capable of being scaled up. Well-oriented, local research can help recognize teachers as actors and not mere beneficiaries or users of well-packed technology solutions.

### **Conclusions**

To date, non-State actors, particularly the private sector, have principally led the response to AI in most countries. Tech giants, concentrated largely in the United States and China, are dominating the development of AI-enabled technologies. The rapid expansion of the EdTech industry is particularly notable, with AI-enabled learning technologies seeing increasing use in the classroom. Nonetheless, more and more governments are beginning to actively implement concrete responses to AI. In developing countries, however, these discussions are far off and limited by structural obstacles.

Education systems have also been actively reorganizing themselves to make certain that learners are obtaining the skills required by an AI-enabled future workplace. These reforms are happening across all educational sub-sectors, from the early years to continuing education. This lifelong learning orientation is of course appropriate in light of how fast AI technologies evolve. As such, UNESCO, given its leadership role in the SDG 4-Education 2030 Agenda, has the mandate to coordinate with national governments and mobilize non-State actors, including NGOs and private enterprises so as to cultivate dialogue and collaboration between industry and the education sector and support the process of rethinking and redeveloping educational programs in response to AI.

The rise of AI makes it impossible to ignore a serious debate about its future role of teaching and learning in higher education and what type of choices universities will make in regard to this issue. The fast pace of technology innovation and the associated job displacement, acknowledged widely by experts in the field (source), implies that teaching in higher education requires a reconsideration of teachers' role and pedagogies. Moreover, many sets of tasks currently placed at the core of teaching practice in higher education will be replaced by AI software based on complex algorithms that can transmit biases or agendas in operating systems.

We believe that there is an urgent need for research on the ethical implications of the current control on developments of AI and the possibility to wither the richness of human knowledge and perspectives with the monopoly of few entities (Floridi & Taddeo, 2016) while it is important to focus further research on the new roles of teachers on new learning pathways for higher degree students, with a new set of graduate attributes, with a focus on imagination, creativity, and innovation.

## References

- Azoulay, A. (2018). Making the Most of Artificial Intelligence. *The UNESCO Courier*, issue no. 3.
- Baker, R. S. (2016). Stupid tutoring systems, intelligent humans. *International Journal of Artificial Intelligence in Education*, 26(2): 600-614.
- Bali, M. (2017). Against the 3A's of EdTech: AI, Analytics, and Adaptive Technologies in Education. *The Chronicle of Higher Education*.
- Chen, S. (2018). China's schools are quietly using AI to mark students' essays... but do the robots make the grade? Society, South China Morning Post.
- China Daily (2018). 'China Launches First University Program to Train International AI Talents'.
- Clancey, W.J. (1987). Intelligent Tutoring Systems: A tutorial Survey. Department of Computer Science. Stanford University.
- Custer, S. et al. (2018). Towards Data-Driven Education Systems: Insights into Using Information to Measure Results and Manage Change. Brookings Center for Universal Education.
- European Commission (2016). Developing Computational Thinking in Compulsory Education: Implications for Policy and Practice. Joint Research Center.
- European Commission (2018). DigComp into Action. Get inspired, make it happen. Joint Research Center.
- Floridi, L. & Taddeo, M. (2016). What is Data Ethics?. *Philosophical Transactions of the Royal Society*.
- Gurney, K. (1997). *An introduction to neural networks*. UCL Press.
- Government of the People's Republic of China (2017). Next Generation Artificial Intelligence Plan.
- Haugeland, J. (1989). *Artificial intelligence: The very idea*. MIT Press
- He, Y. (2017). How China is Preparing for an AI-Powered Future. Wilson Briefs.
- Hilbert, M. (2015). Big Data for Development: A Review of Promises and Challenges. *Development Policy Review*, 34 (1): 135-174.

- Jing, M. (2018). China wants to bring artificial intelligence to its classrooms to boost its education system. *Science & Research*, South China Morning Post.
- Laanpere, M., Pata, K., Normak, P. & Põldoja, H. (2014). Pedagogy-driven Design of Digital Learning Ecosystems. *Computer Science and Information Systems*, 11(1): 419–442.
- Luckin, R., Holmes, W., Griffiths, M. & Forcier, L.B. (2016). *Intelligence Unleashed: an argument for AI in Education*. London: Pearson
- MacCorquodale, Kenneth (1970). On Chomsky's review of Skinner's Verbal Behavior. *Journal of the Experimental Analysis of Behavior*. 13 (1): 83–99.
- MacKay, David, J.C. (2003). *Information Theory, Inference, and Learning Algorithms*. Cambridge: Cambridge University Press
- Manyika, J., Chui, M., Brown, B., Bughin, J., Dobbs, R., Roxburgh, C. & Byers, A.H. (2011). Big Data: The Next Frontier for Innovation, Competition, and Productivity. McKinsey Global Institute. Available at: [http://www.mckinsey.com/Insights/MGI/Research/Technology\\_and\\_Innovation/Big\\_data\\_The\\_next\\_frontier\\_for\\_innovation](http://www.mckinsey.com/Insights/MGI/Research/Technology_and_Innovation/Big_data_The_next_frontier_for_innovation)
- Mayer-Schönberger, V. & Cukier, K. (2014). *Big Data: A revolution that will transform how we live, work, and think*. Eamon Dolan/Mariner Books, USA.
- Nye, Robert D. (1979). *What Is B. F. Skinner Really Saying?*. Englewood Cliffs, N.J.: Prentice-Hall.
- Nye, B.D. (2015). Intelligent Tutoring Systems by and for the Developing World: a review of trends and approaches for Educational Technology in a Global Context. *International Journal of Artificial Intelligence in Education*, 25 (2): 177-203.
- Ohlsson, S. (1992). Constraint-based Student Modeling. *Artificial Intelligence in Education*, 3(4): 429-447.
- Pressey S.L. (1933). *Psychology and the new education*. Harper.
- Pressey S.L. & Janney J.E. (1937). *Casebook of research in education*. Harper.
- Roll, I. & Wylie, R. (2016). Evolution and Revolution in Artificial Intelligence in Education. *International Journal of Artificial Intelligence in Education*, 26 (2): 582-599.
- Russel, S. & Norvig, P. (2010). *Artificial Intelligence: A modern approach*. Pearson Education, Inc. New Jersey, USA
- Samuel, A. L. (1959). Some studies in machine learning using the game of checkers. *IBM Journal of Research and Development*, 3(3): 210-229
- Skinner, B. F. (1936). The Verbal Summator and a Method for the Study of Latent Speech. *Journal of Psychology*, 2 (1): 71–107.
- The European Commission (2018). High-Level Expert Group on Artificial Intelligence. Draft Ethics Guidelines for Trustworthy AI. Available at: [https://ec.europa.eu/futurium/en/system/files/ged/ai\\_hleg\\_draft\\_ethics\\_guidelines\\_18\\_december.pdf](https://ec.europa.eu/futurium/en/system/files/ged/ai_hleg_draft_ethics_guidelines_18_december.pdf)
- Thorndike, E. L. (1911). *Animal Intelligence*. London: Macmillan.
- Toates, F. (2009). *Burrhus F. Skinner: The shaping of behavior*. Houndmills, Basingstoke, England: Palgrave Macmillan.
- UIS (2018). Concept Note: The Investment Case for SDG 4 Data.
- UNESCO (2018). Re-orienting Education Management Information Systems towards Inclusive and Equitable Quality Education and Lifelong Learning. *UNESCO Working Papers on Education Policy*, no. 5.
- U.S. Department of Education, Office of Educational Technology (2012). Enhancing Teaching and Learning Through Educational Data Mining and Learning Analytics: An Issue Brief. Washington, D.C
- Williamson, B. (2015). Governing Software: Networks, Databases, and Algorithmic Power in the Digital Governance of Public Education. *Learning, Media and Technology*, 40 (1): 83-105
- Woolf, B. P. et al. (2013). AI Grand Challenges for Education. *AI Magazine, Special Issue on Intelligent Learning Technologies*. Version 1.

## 8.2. The pseudo-dilemma of Autonomy versus Accountability in Higher Education Policy Reforms in Greece

Vaia Papanikolaou<sup>140</sup>, Yiannis Roussakis<sup>141</sup>, Panagiotis Tzionas<sup>142</sup>

### Abstract

Autonomy defines a group's right to self-government or self-rule. Institutional autonomy is about the freedom to determine curricula, research directions, selection of academic staff and students, as well as the freedom to question received wisdom and to put forward new ideas and controversial opinions. However, autonomy granted to universities is not meant to promote the particularistic interests of a few individuals.

Accountability refers to the responsibility of university administrators to provide reports of their stewardship of public funds. It helps to align institutional priorities with state goals, allow stakeholders to view their progress, and provides a basis for making policy decisions with transparency. However, management appropriate to manufacturing companies may not be effective in the administration of knowledge generation and transfer in university environments. It is a source of great concern to see how certain universities are being dominated by bureaucratic structures.

Accountability can be perceived, in a negative sense, to restrict autonomy, influencing institutional behavior as an external force through the reporting process about how resources have been used. This results to tension building, as academics see themselves alienated from their moral and spiritual duties. Hence the resulting dilemma of choosing between autonomy and accountability.

This paper presents the results of a survey among Greek academics, expressing their views on autonomy versus accountability issues, together with the results of a set of interviews with a European group of academics on the same matter. Additionally, three framework laws governing Greek educational policy reforms for the last 35 years are examined with respect to their autonomy and accountability characteristics.

It is shown that university autonomy is not an end in itself, but a means to achieving the public's goals for universities. Achieving a harmonious balance between autonomy and accountability depends on historical background, accepted norms and practices, and political economy. Thus, the choice between them is a pseudo-dilemma and they should not be considered as parts of a Faustian bargain, where the spiritual value of autonomy is exchanged for some worldly material benefit such as funding. In this sense, a fusion of academic mission and executive capacity is the ultimate goal.

**Keywords:** Educational policy, autonomy, accountability, university

### 1. Introduction

University's role has to do with "*the ability to discover new knowledge*" (Duderstadt 2016:328) and to transfer it to society and further "*to render individuals such that one might reasonably postulate that their opinions all have the same weight in the political domain*" (Castoriadis, 1997:11). Significant characteristics of that task are: intellectual and technological creativity, innovation and invention in research for sustainable development

<sup>140</sup> Dept. of Special Education, University of Thessaly, Greece. Email: vayapap@uth.gr

<sup>141</sup> Dept. of Special Education, University of Thessaly, Greece.

<sup>142</sup> Dept. of Production Engineering and Management, International Hellenic University, Greece.

transformation of old knowledge, ingenuity in pedagogy, protection of academic freedom and institutional autonomy (Eurydice, 2018). Additionally, its role is to provide long life learning opportunities for all of the citizens (Snellman, 2015) and to empower all its members, academic staff and students, to acquire political consciousness in order to actively engage and contribute to society through a democratic university.

Universities possess the significant ability to shape the education of the future citizens and to be the key drivers of *Knowledge Societies*, to act upon the social-political-economic structures and modify and change them if necessary, in a long-life circle. These complex functions are increasing their impact, influence and correlation within the society and also determine their obligation for been accountable to society in one hand and autonomous institutions on the other.

Within a university structure, there are multiple layers of governance and management, stemming from cultural, economic, historical and geographical differences. These should ensure that academic standards are preserved, “excellence” based on equal opportunities and “virtue” in research and teaching (Hoech, 2006) are carried out ethically and accurately, economic and other resources are managed appropriately, and the financial and human resource obligations of the organization are met.

Today’s university faces both challenges and pressures exerted within an economical and technological framework whereas, sometimes its role and institutional organization become a subject of negotiation between the state and the markets. Issues of autonomy, accountability, legal independence and institutional dispute are raised, while there exist, in analogy to society, formal and informal institutions and bodies that are embodied within the democratic operation of the university.

Autonomy involves a distinct mode of ruling, although it is difficult to imagine total university autonomy from external influence as the norm or practice. The degree of such a delegation differs from university to university. Those in favor of university autonomy claim that the state should entrust university leaders, within the existing supervising mechanisms, to make decisions in the best interests of the students, the academics and society as a whole.

Accountability is not about controlling the autonomy of Higher Education Institutes (HEIs) or, simply about creating audit reports and setting legislation constraints; it is about establishing a culture of transparency, a broader social “duty”, a public responsibility and quality accompanied by resource dependence and internal and external stakeholder perspectives. However, there is a broader critique that the origins of social accountability for the public interest can be found in the opportunistic behavior of bureaucrat’s, aiming to expand their bureaus and influence (Olsenn, 2016).

In this paper we present the results of a survey conducted using a questionnaire among Greek academics expressing their views on autonomy versus accountability issues, together with the results of a set of structured interviews with a European group of academics on the same matter. Additionally, three Framework Laws

governing Greek educational policy reforms for the last 35 years were examined with respect to their autonomy and accountability characteristics.

Our intention is to contribute in the broadening conversation and the growing emphasis on the mutually dependent relationship between autonomy and accountability and to the harmonious balance that is necessary to be achieved for an efficient and effective university.

## **2. Basic concepts and definitions**

### **2.1 Autonomy**

The compound word “*Auto-nomy*” is rooted in Greek language, with “auto” meaning “self” and “nomos” meaning “custom” or “law”. This reflects the political sense of the word — a group’s right to self-government or self-rule. When a person seeks autonomy, he or she would like to be able to make decisions independently from an authority figure. Autonomy is, seen from a *Foucauldian perspective*, about taking control of our undertakings, defining our goals, and planning to achieve our needs through our own powers (Yokoyama, 2011).

Castoriadis first used the term ‘autonomy’ in the 1975 version of “*L’institution imaginaire de la société*” (Castoriadis, 1975). He conceives autonomy as “*the capacity, of a society or of an individual, to act deliberately and explicitly in order to modify its law – that is to say, its form [nomos]*”. It is something that is instituted in the social-historical context, and in that sense, it is simultaneously an individual and a collective phenomenon (Straume, 2017:2). “*As embodied in the concrete form of democracy presupposes three things: that society is the source of its own laws, norms and customs (as opposed to an extra-social source, such as God); that these laws and norms are not given once and for all and, as such, can be changed and interrogated; and that there are no pre-given institutional limits or determinations—as such the democratic collective must set its own limits (the task of self-limitation)*” (Adams, 2012).

### **2.2 Institutional autonomy**

University autonomy is about conceptualizing the way in which the university is to be governed, organized and funded. “*At any moment in time the debates on the appropriate level of institutional autonomy reflect the Zeitgeist, that is, the dominant underlying vision with respect to the preferable model of governing and organizing society with the university as a core social institution*” (Maassen et al. 2017:240).

Researchers consider that the true essence of autonomy in the university differs in practice from the autonomy prescribed by the law and is often strongly restricted, conceptually misrepresented and in some cases, even self-defeating.

In the present work, we consider that the dimensions that shape the concept of university autonomy and which are not strictly limited to its legal dimensions, are the following:

a) the freedom of a university within the law:



- ❖ to legislate the regulatory and governmental framework for the legal and disciplinary issues of its members and collective bodies, as well as on the administration of justice
- ❖ to protect the election procedures of its governing bodies, the participation in electoral processes, the composition of the electorate and its constituent members
- ❖ to protect the freedom of academics to prioritize some types of research over others, as dictated by the university's role and mission, rather by market pressures
- ❖ to determine the content of particular courses and the manner in which they are taught, supervised and assessed
- ❖ to determine the criteria for the selection, appointment and dismissal of academic staff and
- ❖ to determine the criteria for the admission of students

b) the freedom of academics within the law:

- ❖ to question and test received wisdom
- ❖ to put forward new ideas and controversial or unpopular opinions, without placing themselves in jeopardy of losing their jobs or privileges
- ❖ to protect the freedom of expression, of speech and thought
- ❖ to promote and protect the tolerance towards diversity, towards heretical approaches and in questioning existing ideas structures
- ❖ to support “excellence” based on equal opportunities and “virtue” in research and teaching. Also supporting the spiritual devotion and commitment shown by the academics, overcoming the individual interest for the sake of an ultimate goal of serving the broader public good

Autonomy is a basic characteristic of the democratic structure of the university, it makes an institute more flexible and responsive and, as competition among autonomous universities is inevitable, it has been proven to be important for successful research and innovation (Michavila et al. 2018; Raza, 2009).

### 2.3 Accountability

It is the trait of being answerable to someone for something, accepting responsibility. *“The term accountability, as it is commonly used in higher education, includes a range of policy issues, not all of which are related to student outcomes. As a general policy construct, it refers to the responsibility (if not legal obligation) of campus and system administrators, as well as governmental officials, to provide their supervisors (ultimately, the public) reports of their stewardship of public funds.”* (Leveille, 2006). It can be considered as “democratic accountability”, referring to higher education's responsibility and duty towards democratic citizenship, in a kind of social contract between higher education and the supporting society (Zumeta, 2011).

It is a principle whose purpose is to govern the relationship between those who delegate authority and those who receive it (Mackie et al. 1995). One should remember that the state, taxpayers, teachers, learners, authorities, officials and administrative staff are all stakeholders in a university (Khan, 2017).

## **Historical Context**

In the late 1960's, access to higher education grew to what was then considered an unprecedented level. Students demonstrated about civil rights and other issues, and the general public became skeptical about the role of mass higher education. Concurrently, the value of all social institutions was being questioned, and the government's role in other social concerns expanded. All of these factors, according to Leveille, (2006), gave significant impetus to higher education entering an era of accountability.

Higher educational institutions therefore, had to become more concerned about growth and diversity as they were increasingly held accountable for the effectiveness and efficiency of their institutions. Primarily, accountability focused mainly on financial concerns but as the concept evolved, the value of higher educational outcomes increasingly came into play. These include upholding the principles of academic freedom and freedom of speech, contributing to society through the pursuit, dissemination and application of new knowledge. Additionally, they should be given the freedom to criticize the state on behalf of the society whenever necessary, as they have been recognized as key social actors.

### **3. Criticism on managerial 'accountability'**

The administration of knowledge generation and transfer in university environments cannot be governed effectively by managerial techniques applied in the field of manufacturing companies or service providers. Bureaucratic and management structures and techniques appropriate for market-oriented businesses cannot be applied, as such, in an institution that generates and disseminates knowledge and, it is alarming to see corporate administrators with no academic experience governing certain universities.

The nature of universities is highly diverse, both with respect to their physical layout and in their different missions and operations. There exist universities comprising a large number of faculties and departments on one hand, and small institutions specializing in very specific areas, on the other. The size of their campuses, the type of the environment they are situated in i.e. rural, urban etc., their building complexes, libraries, student facilities etc. are some of the visible differentiating factors. Moreover, each university has a unique history and purpose, some of them having ancient heritage whereas others have been only recently created through mergers.

Further criticism is exerted on the fact that although forms of learning that engage students actively in the learning process do significantly better than conventional methods in achieving goals, such as critical thinking and problems-solving, accountability is usually based on the improvement of quantitative measures (Downey, 2008). It should be noted that accountability operates firstly at the level of "conscience", making an appointee accountable to himself/herself (Khan, 2017).

There is no point it in assessing institutions exclusively on the basis of small changes in quantitative measures. Assigning relative weighting factors to different university activities, e.g. teaching and research, imposes the

danger that small adjustments of these factors can easily determine the relative positions of major faculties (Mackie et al. 1995).

Finally, in accordance with Goodhart's Law, "*When a measure becomes a target, it ceases to be a good measure*": once an area is subject to measurement, there is an incentive to maximize performance in that area either at the expense of other areas, or at the expense of good ethics (Matthews, 2017).

Therefore, universities' performance in this area of public accountability could be additionally assessed by historians and philosophers as well as by enlightened citizens, editorial writers, and the like (Zumeta, 2011).

#### **4. Threats to Freedom**

Fundamental aim of any accountability process should be to protect the public interest from any type of fraud, to ensure that public funding finds its way to where it is supposed to go, and that claimed academic standards are met, especially with respect to teaching and research. Some kind of intervention should be justifiable to monitor and control the respective qualitative and quantitative indicators each institute adopts.

However, it has been shown that restriction and intrusion do not necessarily lead to accountability but rather to a form of accounting which perpetuates the type of 'master/servant' relationship which lessens responsibility for actions taken and, by virtue of that, lessens accountability (Mackie et al. 1995). The state should frame policies which help achieve the public goals through influence rather than direction (Sandhu, 2015).

The academic 'ethos' is characterized by a set of values, attitudes and beliefs that thrive on academic and administrative independence. This forms the basis for supporting creative processes, research and the pursuit of truth. Moving away from this independence will pose serious threats and may eventually lead to university crisis.

This "*politicization*" of higher education is met nowadays in universities all over the world. Universities usually despise any form of polarization and interventionism, demanding state agreements in order to overcome them. However, the reliance on the state of even the largest and most successful universities is such that withdrawal from state funding would create an unfillable void (Mackie et al. 1995). After all, autonomy is a relative term, which exists to different degrees in different contexts (Sandhu, 2015). The notion of absolute autonomy should be considered a myth rather than a reality (Gandhi, 2013).

#### **5. Building Tensions (and criticism to genuine autonomy)**

The university community's thirst for independence and the pressure exerted by social forces, whether public or private, almost always lead to tensions.

The genuine autonomy of universities has been replaced in many cases by a system of pursuit of power within universities, directly related to political parties in democratic societies or, even worse, the decadence of autonomy in societies ruled by autocratic governments. In some cases, these practices are totally hypocritical and although they pretend to promote autonomy, in reality they hinder universities' independence by putting it

under the control of the governing party or, the lack of such independence is used by the opposition as a pretext for argumentation against the government. The most significant example of political or economic control has been the subordination of universities' sources of funding to the control, not of society at all levels, but to changing political interests and economic pressure groups. This may have catastrophic effects, since political control of education tends to be short-termist and opportunistic (Matthews, 2017).

On the other hand, autonomy granted to universities is not meant to promote the particularistic or personal interests of a few individuals. Academics are not above criticism and they can no longer be viewed as a combination of aristocrats and Franciscan monks (Mackie et al. 1995).

The relationship between accountability and autonomy can be understood through the concept of quality assurance. For this purpose the functions of accountability are defined as follows: “*a constraint on arbitrary power, and on the corruptions of power, including fraud, manipulation, malfeasance, cronyism, nepotism, (Matthews, 2017) and the like*”; and maintenance or enhancement of the “*quality of performance of institutions by forcing them to examine their own operations critically, and by subjecting them to critical review from outside*”. The first function is also related to the idea of autonomy as well as trust, which is sometimes viewed as an opposing concept to accountability. Accountability can, in a negative sense, restrict autonomy, influencing institutional behavior as an external force through the reporting process about how resources have been used and to what effect. Therefore, accountability can be used as a regulatory device. Hence, accountability is often conceptually located in opposition to autonomy as well as professionalism, collegiality, and trust. It can be argued that accountability relies on external values, whereas university autonomy is defined by academics (Yokoyama, 2011).

Governments need to give significant thought to how policy instruments for accountability are appropriately linked to incentives in order to ensure that universities comply with policy directives (Raza, 2009). Including more people with industrial or commercial experience in university bodies strengthens links with economy and, at the same time, improves internal efficiency. However, such representation generates tensions and tends to reduce the relative power of academic interests, since the outside interest does not necessarily predominate. Moreover, universities will not be able to retain a true sense of mission if a large number of academics got alienated from the institutions (Sandhu, 2015)

## **6. Striking a harmonious Balance**

Institutional autonomy is that condition which allows a university to govern itself without external interference. In practice, however, no higher education system is totally free from external control. It can be considered as a boundary condition between university, government and society that are in constant interaction between them, modifying and redefining their mutual relations.

A common argument, mainly among academics, is that academic freedom could justify a lower level of accountability for universities, and as such, accountability could be considered as the exact counter-balance to

autonomy. However, accountability does not detract from autonomy; it simply adds a formal structure of governance to guide policies and decision making. It helps to align institutional priorities with state goals, allow stakeholders to view their progress toward their set goals, and provides a basis for making policy decisions (Leveille, 2006). Additionally, it promotes transparency, both of the academic processes and their outcomes, and demonstrates the quality in the use of public funds (Mackie et al. 1995). A combination of authority, accountability, and management functions are necessary for autonomy to be successful. When good governance and financial management is exercised with a sense of responsibility, autonomy and accountability will create excellence in institutions of higher education. In essence, autonomy and accountability are two sides of the same coin, and complement each other (Eaton, 2018).

As far as government is concerned, university autonomy is not an end in itself, but a means to achieving the public's goals for the universities (Downey, 2008). However if we are truly now part of a knowledge-driven, human capital economy that is highly competitive internationally and this is increasingly widely recognized, then it should also eventually be recognized that public investment in higher education is fundamental to keeping the economic (and socio-political and cultural) engines running, supporting everything else we want to do as a society (Zumeta, 2011).

Achieving such a harmonious balance is an imprecise process dependent on existing and new institutions, historical precedent, accepted norms and practices, and political economy (Eaton, 2018; Raza, 2009). Hence the question of autonomy versus accountability in universities is a pseudo-dilemma.

The first principle of Magna Charta Universitatum declared that “*research and teaching must be intellectually and morally independent of all political influence and economic interests*”. The university is an autonomous institution, lying at the heart of society. Universities are differently organized due to differing geographical and historical conditions and historical heritages. The concept of autonomy does not take accountability out of the equation, and it should be understood as part of the university's identity and functioning as a core social institution. Autonomy and accountability cannot be considered isolated from each other, they are indivisible and their continuously interaction has immediate effects to the universities' results and its democratic establishment. The balance between them in such a degree that the university can still operate appropriately, reflects to its vision, mission and basic functions, as well as to its complex interaction with all social actors and other institutions.

## **7. Autonomy and Accountability in Greek Universities: Case study**

University governance has been characterized as an extremely complex issue. Any attempt to analyze and understand its constitution and operating modes must encompass at least the heterogeneous concepts and processes of autonomy and accountability.

In a European University Association report of 2011 on university autonomy (organizational, staffing, academic and financial management) all Mediterranean countries (Italy, Portugal, Spain, Greece) score very

low compared to other European countries, with Greece scoring the lowest (Michavila et al. 2018). The EUA “University Autonomy Report”, released in January 2011 (Estermann et al. 2011) demonstrates the dependence of Greek universities to the central government, something that prevents their further development. The report stresses the need for reforms towards the strengthening of the academic - economic - administrative autonomy. Moreover, in the “University Autonomy in Europe III - The Scorecard 2017” report, Greece, Cyprus and Turkey were not even included at all, since they could not provide answers to the updated questionnaire or because they were not able to take part in validation interviews (Privot and Estermann, 2017). For each of its publications, the EUA establishes a set of specific indicators. The absence of the Greek universities is reflecting the complexity of the legislation governing their operation as well as their inability to adopt to the different aspects of autonomy, as defined by international organizations in the so called “*Knowledge Society*”.

### **7.1 Autonomy and Accountability in Greek university’s operation under three laws**

In order to highlight the importance of the interaction between autonomy and accountability, a period of thirty-five years of operation of the Greek university is examined operating under three different laws, each one reflecting the historical, social, political, economic and technological environment of its associated era.

For the first time, the self-governance of Greek universities was established as a legal entity, implementing article 16 of the Hellenic Constitution of 1975 about individual and social rights. Article 16 states that: “...*Education at university level shall be provided exclusively by institutions which are fully self-governed Public Entities. These institutions shall operate under the supervision of the State and are entitled to financial assistance from it; they shall operate on the basis of statutorily enacted by-laws*” (The Constitution of Greece, 1975). According to the legislator, this meant that universities were run entirely by their elected bodies, without any state intervention. Obviously, with the constitutional safeguarding of academic freedom, the constitutional lawmaker recognizes the full self-governance of universities, while the common legislator reserves the right to regulate the organization of the structure of the universities. The principle of “*full self-governance*” of universities is the fundamental rule for establishing not only the central but also the regional bodies of the university administration.

#### **7.1.1 The framework of accountability in the three laws**

The conceptual framework of accountability as a social contract and part of the democratic establishment of the institution in all three laws, refers to the accountability of the university to the academic community members as well as to outside bodies that are affected and affect its operation, but in different way.

Law 1268 of 1982 regarded as the highest value the creation of a new culture for the institutions, after a long period of mistrust and dispute prevailing within the universities following the fall of the dictatorship and the revision of the Constitution in 1975. It was considered that trust to the university should be re-established in an attempt to make it a pillar of democratization while, at the same time, seeking to link the university with society by fully capturing the historical context of the time.

Law 1268 introduced the “*National Council for Higher Education*” (ECHR), which comprises social, economic and trade union organizations for the first time and has a voice and role in running the university. However, the council decisions were of an introductory rather than decisive or executive character, coming from a body outside of the university. The same was true for the “*National Academy of Literature and Sciences*” (EAGG) whose role was also advisory, focused on teaching and postgraduate studies. Quality assurance was firstly introduced in Law 1268, however only modestly, as it was considered an innovative characteristic of the operational management of the university.

Under Law 4009 introduced in 2011, a new governance model for Greek universities was established by distributing the responsibilities of administration, supervision, control, approval and strategic development and planning to three distinct institutions, namely the Rector – Council – Senate. Accountability is implemented mainly by the introduction of Councils comprising external members and also, by the association of university performance with an operational management index. With the establishment of the Council in Greek Universities it is ensured that the administration is accountable to it, promoting accountability and true self-governance. The increased participation of external social actors and the minimization of that of students, was introduced for the first time. However, the role of the Council created some confusion about the delegation of authority within the university and it was considered by the academics that it undermines the position of the Rector. Trust, a key ingredient in legitimizing an institution has never been established for the Council, gradually leading to its obsolescence. “*A key reason for the denial of the Councils is the pervasive sense that the Councils are a Trojan Knight, through which Greek higher education will be linked to the private sector and thus no longer be a public good available to all*” (Richard Hunter, president of the council of Aristotle University of Thessaloniki, 2013).

In Law 4009, the new conceptual framework of accountability is directly linked to the quality assurance procedures and, in essence, limits the role of state supervision, thus enhancing the autonomy of institutions. For the first time university funding, administrative functionality and accountability to all stakeholders were linked to the quality assurance procedures. Transparency and accountability were also greatly enhanced by the introduction of compulsory, open electronic publication of all stages of the admission procedures for the election of new faculty members and, similarly, for all the critical operational management procedures.

In 2017, the European Commission on a renewed EU agenda for higher education points that, “*higher education must play its part in facing up to Europe’s social and democratic challenges*” (European Commission, 2017:6). Within this historical context following the economic crisis and as part of the results of the “*National Dialogue on Education*” (held by the Ministry of Education in the period 2015-2016), a new legislative regulatory framework was introduced in August 2017, namely Law 4485, outlining new procedures for the operation of universities in an attempt to re-establish trust to social values.

The attempted reform was clearly visible as it directly affected the principal governing bodies. Councils were totally abolished, thus eliminating all external members to the university. This had a twofold effect: it redefined

the concept of accountability as this was established by the previous reform, and it clearly limited the dynamic interaction between society and knowledge creation.

Although the law starts conforming to European and international reports and recommendations, the quality assurance procedures which were linked to internal and external evaluations were considered of secondary importance. Furthermore, the new law introduced “*The Regional Academic Councils for Higher Education and Research*” which were to devise plans to uphold co-operation between universities and other research regional centers, strengthening their relations and improving the accountability of the regional HEIs.

### **7.1.2 The framework of autonomy in the three laws**

The conceptual framework of autonomy and its features is mapped differently in the three laws, reflecting its complex interactions with society actors.

The self-governance of universities was established as a legal entity for the first time, implementing Article 16 of the Constitution. According to the legislator, this meant that universities were run entirely by their elected bodies, without any state intervention. However, many issues such as their internal regulatory laws, their budget and funding, the allocation of funds, the approval of new faculty positions and so on are still not decided by the university alone but they require the approval of the Ministry of Education.

The explanatory report of law 1268 pointed out that: “*Universities are fully self-governed. This means that the Constitution assures the full self-governance of the entire university, and not only a single body and, even less, a portion of that body. Today Universities are not truly self-governed, but they are run almost exclusively by the body of their full professors. Self-governance does not give the right to universities to operate outside and irrespectively of the laws of the state and irrespectively of the social and national needs determined and prioritized by the free will of the people*” (Explanatory report of Law 1268/1982).

Law 1268/1982 treated the university as a political institution that had to be democratized and be integrated into society, in its wider democratization context, and thus, it considers that decision-making by the governing bodies is an act of political meaning and not a mere technocratic one (Explanatory report of Law 1268 /1982). For the first time the Departments are granted the right to form their curricula autonomously and to elect professors without any state intervention (as it was the case until then). Yet, as it turned out, the lack of association and interaction with professional bodies outside the university led to outdated curricula, with graduates lacking the qualifications required by the labor market. As far as transparency issues are concerned, for the first time the professors’ selection procedures are implemented through appropriate proclamation procedures.

The educational reform introduced in 2011 took into consideration guidance reports produced by international organizations, stressing the need for reforms towards the strengthening of the academic - economic - administrative autonomy, the adoption of the basic principles of the European Higher Education Area (EHAE) and the revision of the legal framework (Estermann et al. 2011; OECD, 2011). It covered a wide range of



aspects such as the university's legal status, funding, quality evaluation, institutional leadership, decision making and internal organization reflecting the concepts of New Public Management practices adopted in the higher education policies. This resulted in a heavier correlation with and dependence on accountability, mainly after the introduction of the Council.

Law 4485 was introduced in 2017, and according to this the role of the state is now decisive in cases of creating, merging or dividing, renaming or even abolishing universities. Also, the state is still responsible for imposing quotas on the recruiting of professors and administrative staff and it may intervene in the approval of postgraduate courses and the determination of their tuition fees.

The characteristics of the proposed reform implemented by this law, strongly affected the operation, financing and strategic planning of universities and seem to contradict the claim of the ministry that universities were becoming more autonomous under this.

A special feature of Law 4485 is the detailed regulatory directives it imposes on the way the university is set up and operates, as well as the increased influence of the role of the Ministry of Education in the validation of the decisions of administrative bodies of the university. It was considered that this limits the degree of autonomy of the universities and alters their notion of accountability. However, despite all the criticism exerted towards the 2017 reform, it resulted in a revolutionary transformation of higher education institutes in Greece. The former Technological Educational Institutes (a status more or less similar to British Polytechnics before becoming Universities) were merged with existing Universities to form new Universities.

## **7.2 Findings of surveys on the Autonomy and Accountability issues**

In order to gain a better insight to the way the notions of autonomy and accountability are perceived, we have contacted a set of structured personal interviews with academics from eleven countries. The interviews were carried out in the period from May to September 2018 (participants coming from Bulgaria, Czech Republic, Denmark, Estonia, Finland, Germany, Greece, Lithuania, Poland, Slovenia, Spain). Fourteen faculty members participated in this research and were interviewed by the researcher, forming a representative sample of the university community.

The interview findings show that the participants identified the following issues as the most important elements of institutional autonomy:

- (i) "The Rector election procedure by an electorate comprising faculty and staff members of all levels plus the student's body and the administrative staff"
- (ii) "True financial autonomy" and
- (iii) "The existence of an autonomous Board of Trustees (comprising both members of the university and from external stakeholders, such as local community authorities – government-market representatives)"

- (iv) “Openness - transparency of all decision-making procedures, with appropriate documentation of all bureaucratic processes”
- (v) “Academic freedom in research”
- (vi) “The ability to autonomously recruit teachers” and
- (vii) “The absence of governmental interference”

A homogeneous set of answers were provided regarding the fact that during the last decade we are facing one the most extensive structural reforms in higher education across Europe and worldwide, focused mainly around the challenge of efficiency and effectiveness for higher education’s institutes. Moreover, the extensive use of technology, the role of market forces and consumerism, the protection of human rights and the excessive number of refugee students, are only some of today’s issues that higher education should take into consideration, as pointed out by the interviewees. It was also pointed out that university mergers are occurring more often than ever in order to achieve economies of scale.

*“The university must be in a position to determine its own path and future and the key component is the university’s leadership team. The university should have a clear vision, mission and strategy as well as operational plans for their implementation”*, as it was characteristically pointed out an interviewee.

On the other hand, the answers to the question *“to whom universities must be accountable”*, form a multiple pieces puzzle as follows:

- (a) ‘To all societal actors, since they are part of, and in constant interaction with, society as a whole playing a crucial role in satisfying its needs, demands and inevitable transformations’ and also because accountability has to do with values, not only education
- (b) ‘To the university community through appropriate self-assessment procedures, since the internal stakeholders have different needs and perspectives in what is valuable’
- (c) ‘To the government, especially because of the public funding and last
- (d) ‘To the local authorities’.

Complimentary to the structured interviews, additional primary data collected via a survey conducted in 2018 (100 questionnaires administered exclusively to members of educational and administrative staff of universities in Greece (Rizopoulou 2018), demonstrate the significant importance of the concepts of autonomy and accountability for the democratic operation of the university. The survey shows the following:

The notions of protecting individual freedoms and human rights at university level are directly linked to institutional autonomy; however, it is interesting to note a dichotomy: 50% of the responders believe that institutional autonomy can guarantee academic freedom whereas the rest 50% disagrees. Maybe this can be attributed to the controversial concept of university *asylum* (asylum in Greek universities is a vague term that

supports free thinking, freedom of expression and the protection and free exchange of ideas and for this purpose, special procedures were to be followed for the presence of police force within the university campus) that was also depicted and associated with the autonomy of the institution, according to respondents.

The freedom in student selection and admission – with respect to their number and qualifications – is considered a crucial factor attributing to institutional autonomy, according to the 68% of the sample.

As far as accountability and its contribution to the democratic governance of the university are concerned, the answers show that this is strongly associated with the electorate composition for the governing bodies of the university and, more specifically, the presence of stakeholders and societal actors from outside of the university. Their involvement within the university is rejected by 63% of the responders (only a mere 13% expresses a somehow positive attitude). Although accountability and transparency in the decisions processes are highly regarded as significant elements for democratic university governance, it turns out that 60% of the sample are implying accountability exclusively to internal university governing bodies.

Moreover, only a 24% of the sample accepts the participation of the students to any decision-taking process. Probably, these results can be attributed to the fact that the sample comprises exclusively university staff.

Finally, a 43% of the sample believes that the university's economic dependence exclusively on state funding may affect severely research, innovation and knowledge creation in universities. Probably this may be attributed to the economic crisis faced in Greece during the past years.

The purpose of this empirical research was to explore the academics perceptions of the principles of autonomy and accountability at university level, and the ways these concepts interact and affect the whole of the university's operations. In conclusion, it is clear that autonomy, accountability, transparency and quality assurance must be incorporated at various levels of the university's functions. The challenges facing the university of the future call for effective policies that promote resilience and diversity in higher education and widen the scope of institutional autonomy, while ensuring effective accountability to all stakeholders.

## 8. Conclusions

As the ancient Greek fabulist Aesop famously said: *“Every truth has two sides; it is as well to look at both, before we commit ourselves to either”*. Universities' representative bodies have overwhelmingly stressed the need for autonomy and self-regulation and notoriously grumbled about the “bureaucratic burden” of external regulation and accountability to external stakeholders. Obviously, there is need for accountability and external oversight, since continued or enhanced public trust is incompatible with self-regulation on its own. This calls out for a balance between autonomy and accountability. Universities are not isolated islands, nor they operate in vacuum. The characteristics demands and transformations of the external social system affect and dictate their operation and responses. Thus, a fusion of academic mission and executive capacity is the goal, rather than substituting one for the other (Sandhu, 2015).

An overall control on autonomy (Kreysing, 2002) could act on university as a Trojan horse, if allowed to transfer the characteristics of endless market competition in an economic model of HEI's (Olssen, 2016). The notion of accountability, as a mutual obligation and a cornerstone of democracy should not be interpreted and used as a contemporary *Panopticon* aimed solely at restriction and control.

As the Council of Europe (2019) emphasizes, “*the future of democracy is at risk in the absence of academic freedom and institutional autonomy, just as it is when the press, media or civil society organizations are weakened and compromised. Increasingly, these freedoms and institutions are threatened and undermined. The community of faculty, staff and students as well as higher education leaders must combine autonomy and accountability, freedom of research and teaching, and societal responsibility*”.

Thus, autonomy and accountability must not be considered as parts of a Faustian bargain, where the spiritual value of autonomy is exchanged for some worldly material benefit such as funding. Accountability is a relatively harmless compromise that the state can afford to ask of autonomous institutions, assuring that public funds are being spent in accordance with public priorities. It seems that autonomous institutions should accommodate such a moderate demand, if they wish to forestall state intervention (Downey 2008) and achieve sustainability (Mackie et al. 1995).

## References

- Adams, S. (2012). Castoriadis at the limits of autonomy? Ecological worldhood and the hermeneutic of modernity. *European Journal of Social Theory*, 15(3) : 313-329.
- Castoriadis, C. (1975). *L'institution imaginaire de la société*. Paris : Editions du Seuil
- Castoriadis, C. (1997). Democracy as Procedure and Democracy as Regime. *Constellations*, 4 (1): 1-18.
- Curaj, A., Deca, L. and Pricopie, R. eds. (2018). *European Higher Education Area: The Impact of Past and Future Policies*. Springer International Publishing.
- Downey, J. (2008). “Accountability versus Autonomy”. Conference Board of Canada Quality Network for Universities.
- Duderstadt, J. (2016). Adapting the University to the Constraints, Responsibilities and Opportunities of a New Age (eds.) Weber L. and Duderstadt J., *ECONOMICA, Glion Colloquium Series No 9*, London, Paris, Geneva.
- Eaton, J.S. (2018). Autonomy and Accountability in Higher Education, North America. In: Teixeira P., Shin J. (eds.). *Encyclopedia of International Higher Education Systems and Institutions*. Dordrecht: Springer.
- Estermann, T. and Kupriyanova, V. (2019). Efficiency, Effectiveness and Value for Money at Universities. A *USTREAM report*. Brussels: EUA.
- Estermann, T., Nokkala, T. and Steinel, M. (2011). *University Autonomy in Europe II — The Scorecard*. Brussels: European University Association.
- European Commission /EACEA/Eurydice (2018). *The European Higher Education Area in 2018: Bologna Process Implementation Report*. Luxembourg: Publications Office of the European Union
- European Commission (2017). Communication from the commission to the European Parliament, the council, the European economic and social committee and the committee of the regions, on renewed EU agenda for higher education. Brussels: European Commission.
- Gandhi, M. M. (2013). Autonomy and accountability in higher education: an Indian perspective. *IQSR Journal of Research and Method in Education, JRM-3 (5)*.
- Hoech, A. (2006). Quality Assurance in UK Higher Education: Issues of Trust, Control, Professional Autonomy and Accountability, *Higher Education*, 51 (4): 541–563.
- Khan, J. (2017). *Accountability in Higher Education in the Context of Autonomy of the Universities*. New Delhi: NUEPA.
- Kreysing, M. (2002). Autonomy, accountability, and organizational complexity in higher education: the Goettingen model of university reform. *Journal of educational administration*, 40(6): 552-560.

- Law 1268/1982, Government Gazette 87/ issue A/16-07-1982, “For the structure and operation of Higher Education Institutions”
- Law 4009/2011, Government Gazette 195/ issue A/06-09-2011, “Structure, function, quality assurance of studies and internationalization of higher education institutions”
- Law 4485/2017, Government Gazette 114/ issue A/04-08-2017, “Organization and operation of higher education, arrangements for research and other provisions”
- Leveille, D. (2006). *Accountability in Higher Education: A Public Agenda for Trust and Cultural Change*. Berkley, California: CSHE.
- Mackie, D., Martin, J., & Thomson, K. (1995). Autonomy versus accountability: Maintaining the delicate balance. *Tertiary Education & Management*, 1(1): 62-71.
- Maassen, P., Gornitzka, Å., & Fumasoli, T. (2017). University reform and institutional autonomy: A framework for analysing the living autonomy. *Higher Education Quarterly*, 71(3): 239-250.
- Matthews S. (2017). Autonomy and Accountability in Higher Education: Lessons from Ghana and Mexico. Institute for democracy and economic affair, *Policy IDEAS*, No.39
- Michavila, F., & Martinez, J. M. (2018). Excellence of universities versus autonomy, funding and accountability. *European Review*, 26(1): 48-S56.
- OECD (2011). *Education Policy Advice for Greece, Strong Performers and Successful Reformers in Education*. OECD Publishing.
- Olsen, J. P. (2009). Democratic government, institutional autonomy and the dynamics of change. *West European Politics*, 32(3): 439-465.
- Olssen, M. (2016). Neoliberal competition in higher education today: Research, accountability and impact. *British Journal of Sociology of Education*, 37(1): 129-148.
- Privot E.B. and Estermann T. (2017). *University Autonomy in Europe III The Scorecard 2017*. Brussels: EUA.
- Raza, R. (2009). *Examining autonomy and accountability in public and private tertiary institutions*. Washington, DC: World Bank.
- Rizopoulou, E. (2018). Institutional structure of the university, democratic institutions and the role of administrative, (Unpublished master’s thesis), Department of Business Management, Alexander Technological Educational Institute of Thessaloniki, Thessaloniki
- Sandhu, R. (2015). Autonomy and accountability in higher education. *International Journal of Research in IT, Management and Engeeniring*, 5(1): 15-22
- Snellman, L. (2015). University in Knowledge Society: Role and Challenges, *Journal of System and Management Science*, 5(4): 84-113.
- Straume I.S. (2017). Castoriadis on Autonomy and Heteronomy. In: Peters M.A (eds), *Encyclopedia of Educational Philosophy and Theory*. Springer, Singapore.
- The constitution of Greece, Government Gazette 111/ issue A/09-06-1975, Library of the Hellenic Parliament.
- Yokoyama, K. (2011). Quality assurance and the changing meaning of autonomy and accountability between home and overseas campuses of the universities in New York State. *Journal of Studies in International Education*, 15(3): 261-278.
- Zumeta, W. M. (2011). What does it mean to be accountable?: Dimensions and implications of higher education's public accountability. *The Review of Higher Education*, 35(1): 131-148.

### **8.3. The challenges of forging a new policy for an inclusive religious education in Greece**

*Zoe Michalopoulou<sup>1</sup>*

#### **Abstract**

The resettlement and inclusion of migrants and refugees in host societies is an important issue, which is very much prominent on the social sciences agenda. This is not surprising when taking into account that only in Europe in 2011 the global number of refugees was approximately 1.5 million people (UNHCR, 2011). The significant size of this population means this is not a topic, which social scientists can afford to leave under-researched. Moreover in the past years there has been an evident increase in migration flows worldwide, due to the on going wars and socio-political tensions in the Middle-East and Africa. Especially after 2016, when FYROM closed the borders to refugees and migrants, thousands of people have been left stranded in Greece and therefore have to resettle in the country.

Migrants and refugees originate from various countries and socio-cultural groups. Inter-cultural tensions may arise, while the tolerance of the host society is put to the test. Due to the above rapid social developments, the educational system should be able to confront the new challenges and focus on ways to form a more inclusive society.

The proposed paper argues that this is the main reason a new policy regarding religious education should be considered. It should be noted that in the current Greek context, the existing legislative framework and the corresponding policies do not adequately accommodate the religious freedom of the incoming populations. Furthermore, when the Greek Government tried to reform the program of religious education in 2016, the Council of State (Symvoulio tis Epikrateias) annulled the said legislation, citing that it violates the religious freedom of the majority of the population i.e. Christian Orthodox (decision number 660/2018).

The paper will analyze the different policies concerning religious education in Europe, that faces similar problems, and will try to propose a new one for the Greek schools taking into consideration not only the social issues that have arisen during recent years but also the existing constitutional framework regarding religious freedom, as it has been interpreted by the Greek courts.

**Keywords:** migration, educational policies, integration policies, religious freedom

#### **Introduction**

The resettlement and inclusion of migrants and refugees in host societies is an important issue, which is markedly prominent on the social sciences agenda. This is not surprising when taking into account that only in Europe in 2011 the global number of refugees was approximately 1.5 million people. The significant size of this population means this is not a topic, which social scientists can afford to leave under-researched. Moreover in the five past years there has been an evident increase in migration flows worldwide, due to the on going wars and socio-political tensions in the Middle-East and Africa.

In Greece, specifically, according to the latest data published by the United Nations High Commissioner for Refugees (UNHCR, 2019a) there are currently 88.750 refugees and migrants living in the country (25.250 on the islands and 63.500 in the mainland). It is estimated that over one third of the newcomers are children. Especially after 2016, when North Macedonia closed the borders to refugees and migrants, thousands of people

---

<sup>1</sup> Aristotle University of Thessaloniki, Greece.

have been left stranded in Greece. Furthermore the Dublin Regulation (EU no. 604/2013), which sets the criteria for determining the Member State within the EU responsible for examining the application of asylum seekers, clearly stipulates that if a person who seeks international protection enters Greece irregularly, then his/her application will be examined here. There are exceptions to this rule, mainly regarding family reunification purposes. After the culmination of the migrant crisis in late 2015 to early 2016, when the EU adopted emergency measures relocating approximately 66.500 asylum seekers from Greece to other member states, no similar action seems probable. Therefore it is a given fact that refugees and migrants will make Greece their home for the foreseeable future.

### **Main issues**

Migrants and refugees originate from various countries and socio-cultural groups. Inter-cultural tensions may arise, while the tolerance of the host society is put to the test. Due to the above rapid social developments, the educational system should be able to confront the new challenges and focus on ways to form a more inclusive society. It is largely accepted that in an ever changing and diverse world it is necessary to acquire a series of skills in order to develop a “culture of peace”, so that social conflicts that will unavoidably arise will be handled constructively (Del Espino Diaz, 2018: 47). Due to the aforementioned rapid social developments, the educational system needs to address the new challenges and focus on ways to promote a more inclusive society. Moreover,

Since school is seen as a mirror of society but also the place where citizens are formed and learn to live together, religious education has become important, especially under the abovementioned developments; because it is impossible to understand a different culture without understanding its religion first (Del Espino Diaz, 2018).

Approaches to religious education (RE) throughout Europe are varied but remain closely related to the history of each country. There are two basic models of RE:

1. confessional teaching, in which the defining feature is the assumption that the goal of the subject is to nurture one faith, irrespectively of whether the students participate in religious practices or even reject religion. In a confessional approach the objective is to learn about religion and also to learn from and through religion (Stoeckl, 2015; Willems 2015). Confessional RE is still widespread in Europe but in most cases it is an optional subject (Del Espino Diaz, 2018).
2. non confessional teaching, in which the goal of the subject is to promote knowledge and understanding of different religions for all students (Stoeckl, 2015). However even non confessional teaching focuses on the dominant faith of the state i.e. Christianity. Non confessional teaching is usually found in northern protestant countries and it is generally compulsory (Pepin, 2009).

France holds a unique position in the field of RE. Due to the constitutional principal of laicite (strict secularism), religious teaching was banned from schools until the early 2000's. However after 2002 the

teaching of “religious facts” was introduced to the French public educational system, not as an individual subject but in the framework of the most relevant courses such as history, literature, arts etc (Pepin, 2009).

Religious Education in Greece has - for the longest time- been confessional (Sotirelis, 1993). This reflects the history of the country and the role the Greek Orthodox Church has played in creating the modern state. The subject is compulsory from the third grade of primary school but there is an opt out option for students that are not Christian Orthodox. The law does not stipulate the criteria on which the parents can exclude their children from RE. According to the latest guidelines provided by the Ministry of Education the exemption can only be justified for reasons relating to the protection of religious freedom and the school principals are advised to review these reasons carefully<sup>2</sup>. If the student is exempted from RE there is no alternative course so usually he/she has a free period. It should be noted that very recently the European Court of Human Rights held unanimously, that Greek system for exempting students from religious education classes breaches the European Convention<sup>3</sup>. As a result the new Minister of Education promised to change the above - mentioned system for the educational year 2020-2021.

As in the majority of European countries (Del Espino Diaz, 2018: 49-50; Llorent – Vaquero, 2018: 158-162), RE is regulated by the Greek constitution. Article 16 § 2 states that “*Education constitutes a basic mission for the State and shall aim at the moral, intellectual, professional and physical training of Greeks, the development of national and religious conscience and at their formation as free and responsible citizens*”. Constitutional theory considers this provision a great advancement in comparison to the previous Constitution of 1952 (Sotirelis, 1993), according to which “*Teaching in all primary and secondary schools shall aim to promote the moral and intellectual education and to develop the national conscience of the youth according to the ideological principles of the Greek Orthodox culture*”. Furthermore article 13 § 1 guarantees religious freedom stating that “Freedom of religious conscience is inviolable. The enjoyment of civil rights and liberties does not depend on the individual’s religious beliefs”. On the other hand article 3 of the constitution reads as follows “*The prevailing religion in Greece is that of the Eastern Orthodox Church of Christ*”. The word “prevailing” has long been the subject of different interpretations. Today the established theory is that article 3 merely reflects the fact that the large majority of Greek citizens belong to the Orthodox Christian faith. It has no further connotations and it should not be the basis for interpreting other constitutional rights (Sotirelis, 1993). Otherwise religious freedom cannot be fully guaranteed.

The government that was elected in 2015 decided to reform the model of RE from confessional to non confessional both in primary and secondary education. The ministerial decrees that promulgated the new educational programs regarding RE were contested before the Council of State (Supreme Administrative Court) by parents, a religious group and priests.

---

<sup>2</sup> See the circular of the Ministry of Education, Research and Religious Affairs dated 23 January 2015, which sets out the procedure for exemption from the religious education course.

<sup>3</sup> Case Papageorgiou and others v. Greece (application nos 4762/18 and 6140/18).



The Council of State held that the new educational programs that transformed the model of religious education violate:

- A. article 16 par.2 of the GC, because they undermine the development of the Greek Orthodox conscience of students which is an imperative of the Constitution,
- B. Article 13 (religious freedom), because religious education must be exclusively oriented towards Greek-Orthodox students in order to protect their religious freedom
- C. Article 2 of the 1<sup>st</sup> Additional Protocol to the European Convention on Human Rights, since Greek-Orthodox parents cannot ensure their children's education according to their religious beliefs and
- D. The principle of equality (article 4 par.1 GC), because the Greek-Orthodox students are deprived of their right to be taught exclusively about the principles and the doctrine of their religion<sup>4</sup>.

It should be noted that according to the dissenting opinion of the court the new educational programs that were implemented after consultations with the competent scientific bodies of the educational community, are in accordance with the constitutional obligation of the State to provide a pluralistic and neutral religious education and at the same time provide an adequate teaching of the Greek Orthodox doctrine. Consequently, they did not violate any constitutional provision or the European Convention on Human Rights<sup>5</sup>.

Unfortunately, the decision should not come as a surprise for legal scholars, since it is a reprise of the established case law of the court in matters relating not only to RE but to religious freedom of the Greek Orthodox community (Sotirelis, 1993). The main legal argument against the interpretation that was rendered concerning the constitutional provisions is that the meaning of article 16 § 2 of the Constitution is much broader. The state is responsible for providing an education that promotes the formation of citizens with a religious conscience no matter what their faith is. To claim that the only religious conscience that must be nurtured in schools is the Christian Orthodox is not only dated but most importantly it implies that religious freedom in Greece is mediated by the prevailing religion of the country. In other words the implications of the courts decision could mean that in Greece a person can express his/hers different religious faith as long as it doesn't interfere with the Greek Orthodox dogma.

Secondly, judicial review cannot be so far reaching because its function is alternated and it becomes a review of the policies put into place by the democratically elected Parliament. The role of judges is to resolve disputes and not to express binding opinions concerning the Governments decisions. Nonetheless, one could argue that the Ministry's choice to change the characteristics of RE both in primary and secondary education was done in haste without an extensive dialogue with the main governing body of the Greek Orthodox Church. This led to a backlash from church officials and theologians. After the decision was rendered, the Government changed

---

<sup>4</sup> Council of State decisions 660/2018 and 926/2018.

<sup>5</sup> For the dissenting opinion see decision no. 660/2018, par. 19 and decision no. 926/2018, par. 15.

the educational programs and consequently the books of RE to seemingly respect the judgment. However the content remained intact, that is non-confessional. Last week it was announced that once more, the Council of State held that the new books were still not in compliance with its previous judgment. The full text of the decision is still not available so we must wait before commenting on that, however it seems that the Court followed the established case law.

## Conclusions

The above analysis leads to the following question: Should RE revert to the previous confessional model or is there an alternative? It appears almost certain that RE will go back to a confessional teaching. At the same time a less strict confessional model can be introduced in the later grades of high school in order to accommodate the changing Greek society. Additionally the conditions of opting out must be clearly regulated and parents should be informed of their choices. Ideally Greece could learn from the examples of Spain and Italy, countries where the Catholic Church has deep routes in society. In both EU countries RE is offered as a course in all public schools, but it is optional (parents can opt in instead of opting out). Moreover an alternative subject is provided for students who do not wish to attend RE classes. Data in Spain shows that the rate of participation and interest in RE drops, as students grow older (Pepin, 2009).

In conclusion, Greece faces a great challenge in introducing a new policy regarding RE. On one hand it has to comply the recent decisions of the Council of State but on the other it cannot disregard social change especially under the present conditions and the pressure migration flows has and will continue to put in the host society. It is imperative for the Government to take the necessary steps in order to ensure a level of integration of the incoming populations with respect to their cultural and religious diversity<sup>6</sup>. Otherwise we run the risk of living in a country where the berated doctrine of “separate but equal” is fully justified.

## References

- Del Espino Diaz, L. (2018). A Comparative Analysis of Religious Education in Europe and Educational Guidelines in the Framework of Interreligious dialogue and a Culture of Peace. *Mediterranean Journal of Social Sciences*, 9 (1): 47-58.
- Llorent - Vaquero, M. (2018). Religious Education in Public Schools in Western Europe. *International Education Studies*, 11 (1): 155-164.
- Pepin, L. (2009). *Teaching about Religions in European School Systems, Policy issues and trends*. London: Alliance Publishing Trust.
- Sotirelis, G. (1993). *Religion and Education*. Athens: Sakkoulas (in Greek).
- Stoeckl, K. (2015). Knowledge about religion and religious knowledge in secular societies. In: K. Stoeckl (ed.), *The Future of Religious Education*. European University Institute, pp. 1-6.
- UNHCR (2019a). Fact Sheet - Greece, 1-31 August 2019.
- UNHCR (2019b). Stepping Up: Refugee Education in Crisis. Report UNHCR.
- Willems, J. (2015). Religious Education and the Student’s Fundamental Right to Freedom of Religion - Some Lessons and Questions from Germany. In: K. Stoeckl (ed.), *The Future of Religious Education*. European University Institute, pp. 27-38.

---

<sup>6</sup> According to UNCHR (2019b) more than three quarters of the 4.565 school-aged children on the Greek islands do not attend school. However most refugee children (64%) on the Greek mainland are enrolled in public schools.

#### 8.4. From inclusive to equal European public spheres: bringing the theories of feminism and agonistic pluralism back in

*Aristeidis Myriskos*<sup>1</sup>

##### **Abstract**

The last decade, the European Commission, in order to tackle the democratic deficit in the European Union, among other initiatives, focused on the formation of the European public sphere. The political public sphere is constituted by citizens' public debates on issues of common concern. Its aim is to further the accountability and responsiveness in institutions' decision-making process. The European Commission, in its effort to shape the European public sphere, reflected the normative liberal model of rational consensus and it highlighted the importance of the European identity and European Union's core values. Racial, ethnic, and religious groups that are not identify with the European ideals face exclusions from the European public sphere. The paper analyses these exclusions, focusing on the marginalization of Muslim immigrants and deriving its arguments from the theories of feminism and agonistic pluralism. More specifically, it retraces the late twentieth century feminist reading of Jürgen Habermas' and Hannah Arendt's works in order to suggest an alternative model of the European public sphere based on the values of agonistic pluralism. The feminist critique and the deconstruction of the normative theories deployed by Arendt and Habermas proved illuminating for the public sphere theory. Nevertheless, it was left aside in the European public sphere research. In the examination of inequalities produced in the European public sphere, the value of feminism and agonistic pluralism stems from two facts: First the theories view the rational consensus and the deliberative democracy not only as utopia but also as dangerous practice and they point to the contestational dimension of pluralism as the vital element of democracy. Second, they tend to stress the importance of politics of everyday life, the experiences and the knowledge of disadvantaged groups which are not communicated efficiently.

**Keywords:** European public sphere, deliberative democracy, rational consensus, agonistic pluralism

##### **Introduction**

The late twentieth century feminist critique and the deconstruction of the normative theories deployed by Hannah Arendt and Jürgen Habermas proved illuminating for the public sphere theory. As the political public sphere plays a vital role in democracy, it was examined in the European Union context by many researchers, yet not exhaustively. Despite its contribution on the public sphere theory, the feminist standpoint was left aside in the European public sphere research.

This paper retraces the late twentieth century feminist reading of Habermas' and Arendt's works in order to suggest an alternative model of the European public sphere based on the values of agonistic pluralism. From a feminist view, the limited perspective of the mainstream studies of the European public sphere is premised on their focus on media as well as on the fact that, taking for granted the normative framing of the political realm, they examined only specific debates that the media covered. Contrariwise, the feminist standpoint tends to

---

<sup>1</sup> Doctoral Researcher, Bielefeld Graduate School in History and Sociology, Bielefeld University, Email: aristeidis.myriskos@uni-bielefeld.de

stress the importance of politics of everyday life, the experiences and the knowledge of women and marginalized groups which are not communicated efficiently. Moreover, the agonistic trends of the feminist theory point to the contestational dimension of pluralism as the vital element of democracy and view the rational consensus and the deliberative democracy not only as utopia but also as dangerous practice.

In an inhomogeneous EU which is characterized by many inequalities and multiple different interests, an inclusive, transnational European public sphere through a deliberative process of consensus is not feasible. Rather, accepting the inevitable contestational dimension of the public debates and searching how all publics in EU could acquire the same status and engage more actively in decision-making seems a more realistic and viable solution.

### **The normative approach of the public sphere: Jürgen Habermas and Hannah Arendt**

In “The Human Condition” Hannah Arendt asserted that the economic processes of the modern world and the emergence of individualism resulted in the “transformation of the public space of politics into a pseudo space of interaction in which individuals no longer act but merely behave as economic producers, consumers and urban city dwellers” (Benhabib, 1992: 90). The claim made by Arendt that the personal interests have no political orientation for the common good was welcomed in Jürgen Habermas’ conceptualization of the public sphere.

Habermas’ theory on public sphere, like all subsequent ones, aims to study the role of public communication in furthering the accountability and responsiveness in the decision-making process. Habermas (1964) described the public sphere as the gathering of private persons which discuss matters of public opinion. Deploying the model of deliberative public sphere, he saw citizens’ political opinion rising from the social space as a result of deliberate discourse. The public sphere is formed through the processes of identification, filtering and interpretation of themes and contributions that emerge from autonomous public spheres. The core element of this process is the normative conception of rational speech (Lubenow, 2012). As Gabriela Tănăsescu mentioned, the social interaction in the normative public sphere “far from assuming the equal of status, disregards the status” (Tănăsescu, 2014: 151).

### **The feminist standpoint, the deconstruction of identity and agonistic pluralism**

The Feminist standpoint theory was developed in the 1970s and 1980s. As Iris van der Tuin described it, the theory, prioritizing women’s thinking and marginalized lives, focused on the “intersection of everyday practices of exercising power and the production of knowledge”. A basic hypothesis was that “a social disadvantage implies an epistemological advantage” (Tuin, 2016: 1). This assumption resulted to a critical analysis of the political realm and the public sphere.

For instance, the “Human Condition” was treated as an anti-modernist political work. Adrienne Rich called this book failure, lofty and crippled for it “embodies the tragedy of a female mind nourished on male ideologies” (Rich, 1979: 211-212). As Ann Lane noticed, for Rich, Arendt is a “male-oriented thinker oblivious

to the everyday conditions of women's lives, rigidly separating private and public, production and action, social and political" (Lane, 1983: 109). Likewise Hanna Pitkin, claimed that Arendt's "exclusion of material concerns (and bodily functions as well)" from the public realm could also imply the denial of the emancipation of women. According to Pitkin "the exclusion of everything merely necessary or useful from political life means simply the exclusion of the exploited by their exploiters". On public/private distinction Pitkin commented that "what we need is not separation but linkage...far from excluding the social question as unworthy of political life, we need to make it political in order to render it amenable to human action and direction" (Pitkin, 1982: 327, 336).

Similarly, Fraser asserted that Habermas' normative approach is problematic, as it provides a merely bracketing of the social inequalities, instead of suggesting how they could be eliminated. As an alternative to the single public sphere, Fraser suggested a concept of multiple publics. In this concept, the point is to include in public debates interests that the habermasian masculinist, limited and exclusionary model name private. For Fraser, the labelling of interests as private is resulting to a tight scope of analysis. A supporting example of her approach is the late twentieth feminist public sphere, what she called "subaltern counterpublic". This public sphere tried to deal with its exclusion from the official public spheres through an alternative interpretation of social reality (Fraser, 1990: 67).

What is also interesting is the feminist reconsideration of Habermas' and Arendt's theories, which shows how their conceptual tools can become fruitful for the feminist model of public sphere. Jean Cohen, reconsidering Habermas' categorial framework, which has been accused as androcentric, claims that it "has to offer to the analysis of social movements in general, and the feminist movement in particular". For Cohen, it is not this framework that is problematic but its application by Habermas as well as the prejudices on Habermas' theory regarding feminism (Cohen, 1995). As regards the rethinking of Arendt's view on gender and public realm by feminists, this can be categorized in two groups. The one attempts to draw a feminist standpoint from Arendt's work, whereas the other follows a deconstructionist approach of Arendt's thinking.

The first group includes arguments posed by Nancy Hartsock, Terry Winant, Ann Lane and Seyla Benhabib. Hartsock asserted that Arendt's view of power as a means of collective action was a significant contribution for the feminist theory "grounded at the epistemological level of reproduction" (Hartsock, 1985: 259). Hartsock regarded that Arendt's work provides food for thought on how women, gaining access to men's spheres of life, could mute the antagonism among different social spheres. Moreover, Winant, analysing Hartsock's and Fraser's works, concludes that Arendt provides the missing link for the establishment of feminism in philosophy (Winant, 1987). Also, Benhabib stressed that in Arendt's work "there are a number of fascinating portraits of women" and that "fitting these women, their lives and aspirations and Arendt's views of them into the categorial structure of her political thought is still a hermeneutic task to be undertaken" (Benhabib, 1993: 97, 99). Likewise, Lane suggested that "focusing our attention on the importance of Arendt's

background of Jewish cultural and political experience allows us to see the relevancy of her work for feminist theory and action” (Lane, 1983: 110).

Regarding the second camp that is mentioned above, the feminist value in Arendt's thinking is not premised on a gynocentric reading of her work. Instead, the illuminating part in Arendt's theory is her concept of collective action, especially its agonistic dimension. This consideration was a result of various conceptualizations of the female identity. As Mary Dietz points out, some feminists moved from the feminist standpoint, which was linked to the distinctive character of women as a group, to a process of “hybridizing and complicating women in terms of an identity complex of race, class, ethnicity, culture, sexual identity and/or sexuality” and also to a deconstructive approach which “dismantles the fixity of identity” (Dietz, 1995: 33, 37).

Such an approach is compatible with Arendt when she says that “in acting and speaking men show who they are....Although nobody knows whom he reveals when he discloses himself... he must be willing to risk the disclosure” (Arendt, 1998: 179, 180). This sentence triggered Bonnie Honig to note that “Arendt's actors are...never really in control of what they do in the public realm” and to wonder “If labour can be performative action, why not the body itself? Why not... de-essentialize and denaturalize the body?” Honig criticized Pitkin for not acknowledging the fact that Arendt, rejecting the identity politics, welcomes “a performative politics that, instead of reproducing and re-presenting what we are, agonistically generates who we are by episodically producing new identities” (Honig, 1998: 104-105, 108, 113). Joanne Cutting-Gray regarded Arendt's theory as the base for the feminist “dissolution of the female as any set identity” (Cutting-Gray, 1993: 35, 49). Likewise, Dietz argues that “Arendt realizes human beings are ineliminably bound to nature, but we are also able to act in ways that at least temporarily defy the unremitting play of natural forces”. On Hartsock's emancipatory vision, Dietz comments that it does not include any of the conceptual categories which are vital for the theory of emancipatory politics, that is, diversity, solidarity, action-coordination, conflict, plurality and the political equality of women as citizens. Rather, the “Human Condition” articulates “a conception of politics and political equality as collective action and the mutual engagement of peers in a public realm” (Dietz, 1995: 245-247, 250).

As Finn Bowring observed, there is an affinity between the above “social constructionist re-workings of Arendt” and Chantal Mouffe's concept of agonistic pluralism and democracy (Finn, 2011: 137). Mouffe claimed that Habermas' utopian concept of consensus through deliberation reveals the fact that “the domain of politics... is not a neutral terrain that could be insulated from the pluralism of values and where rational, universal solutions could be formulated”. Like the feminist view of the female identity as subject to constant changing and progressive evolvment, Mouffe condemns Habermas' rational consensus theory because it “sees the individuals as prior to society, as bearers of natural rights...(and) abstracted from social and power relations, language, culture and the whole set of practices that make the individuality possible”. Highlighting the vital role of social relations and identities, the aim of the concept of agonistic pluralism that Mouffe deploys

is to “subvert the ever-present temptation existing in democratic societies to naturalize its frontiers and essentialize its identities” (Mouffe, 2000: 8, 17).

### **Rethinking the European public sphere**

As Thomas Risse and Marianne van de Steeg stressed, if the aim of the public sphere is to put decision-makers accountable for their actions, the case of the policy-making process in European polity should not be an exception. The early studies on the European public sphere, based on Habermas’ normative theory on the national public sphere, examined the case in which EU, as a supranational entity, could produce its own, separate from the national context, public sphere (Steeg & Risse, 2010). At some point, it became obvious that Habermas’ original conceptual tools couldn’t be applied on a post-national case. This acknowledgement was repeatedly stated by Habermas himself. Habermas described the European public sphere as “a political public sphere which enables citizens to take positions at the same time on the same topics of the same relevance” (Habermas, 1995: 306). Based on this conceptualization, the studies turned in to track either a vertical or a horizontal Europeanization of the national media of member states, where vertical Europeanization meant media’s attention to EU issues and horizontal media coverage of events and debates in other member states (Brüggemann & Kleinen von Königslöw, 2007).

The narrow perspective of these studies is premised on their trend to regard the potential emergence of the European public sphere as a result of a rational consensus. Taking for granted the deliberative model of Habermas, they examined cases of EU citizens’ common approach on European issues to detect the rise of the European public sphere. Moreover, in this context, most of them considered that such a case could be proved through media research, since media function as citizens’ voice. But media are only one element of public debate and the normative conception of democracy, focusing on consensus, is only one point of view. As Fraser remarked, a simple mapping of existing communication flows consists a limited approach. What is needed in critical social and political theory is the reconsideration of “core premises concerning the legitimacy and efficacy of public opinion” (Fraser, 2007: 24). Jeffrey Wimmer also agreed that the public, as a space of communication, cannot “be reduced analytically to the media public” (Wimmer, 2005: 101).

In the research of the formation of public opinions in EU, one has also to acknowledge the dynamics of the political dimension of the everyday life, which were highlighted by the feminist standpoint theory. Like Craig Calhoun mentioned, critiques on Habermas argued that his idealist theory flawed because it was “framed too much in terms of the setting aside of disparate social identities and experiences rather than their thematization as bases for public discourse” (Calhoun, 2010: 304). Natalie Fenton rightly concluded that “what is most interesting are the moments when counter-publicity breaks through into the common domain in its own right...providing the opportunity for ideological claims to be displaced, ruptured or contested” (Fenton, 2003: 200). Fenton and John Downey reminded us that counter-public spheres, as a source of experience, either

complementary or contrary to sovereign public spheres, constitute a “vital impulse to democracy” (Fenton & Downey, 2003: 22).

Fraser’s concept of multiple public spheres as well as the elements of agonistic pluralism in Honig’s and Dietz’s works, which are also deployed in Mouffe’s theory, seem more consistent with the current inhomogeneities within EU. As Kari Karppinen pointed out, “While European social reality is increasingly characterised by diversity and pluralism, the insistence on rational consensus is seen as too idealised, too unrealistic, and too academic” (Karppinen, 2009: 58). Rather, Mouffe’s perception of agonistic democracy, as Terje Rasmussen asserted, seems more accurate when it comes to the EU financial and migration crisis (Rasmussen, 2016). Nevertheless, the critical analysis of the normative theorization of public sphere and the agonistic trends of feminism were not taken into account in the research of the European public sphere.

Furthermore, using the feminist deconstruction of the normative model of public sphere in order to detect common perspectives between multiple publics, which are supposed to prove a single transnational public sphere in EU, is not enough. Likewise, it is not sufficient the arguing in favor of a more inclusive European public sphere. As long as the discussion is about how *the* transnational European public sphere will become more inclusive, it still remains stuck in Habermas’ deliberative model and the normative consensus solution. In such a context, the debate on the European public sphere remains not only a limited discourse but also one that provides neither a realistic explanation of the present public communication in EU nor an effective model for democracy. Because, as Fraser and Mouffe remarked, a consensus that produces exclusions is not able to contribute in the progress of a democratic society. Instead, it is dangerous for its very existence.

In the effort to render the public communication able to forward the responsiveness and accountability in decision-making process, there is no need to strive to establish a public debate capable of including every interest and every voice through consensus. Such a kind of practice is utopia. Instead, a plausible task would be to make sure that all public spheres will be equal and their voices will be taken into account in the same way in the policy-making process, so they will be able to demand the protection of their rights and their interests; A task, similar to that Ernesto Laclau and Mouffe set in the “Hegemony and Social Strategy”, that is, to create a “chain of equivalence among the various democratic struggles against different forms of subordination” (Laclau & Mouffe, 2001: 18). The theoretical concept for such a case could be derived from the feminist concept of the public sphere which was left aside in the mainstream approaches of the European public sphere.

The contribution of the feminist perspective on the public sphere to the EU context lies first, in the profound research and critical, alternative reading of the issue of private and public realm from the feminist standpoint. The prioritizing of marginalized groups’ lives, experiences and knowledge from the feminist standpoint theory, is crucial in revealing the weak status of subaltern publics and in explaining completely the European public sphere. In the task of showing the inevitable action of counter-publics and of furthering the interests of weak publics as well as in revealing this process as more stable and fair one, the feminism of the late twentieth



century is also illuminative for its pluralistic values and its agonistic dimension, which were resulted from the deconstruction of the female identity.

A process of retracing the feminist critique as well as the reconsideration and deconstruction of Arendt's and Habermas' normative theories could widen the scope of subjects and actors that are under examination in the analysis of the European debates. The values of the feminist standpoint theory are helpful in forwarding the interests not only of the women class in EU but also of all marginalized groups. Moreover, the agonistic and pluralistic approach of feminism proves the unfair relations between those groups and sovereign ones as well as the need for the subversion of this relationship and its replacement with one of balance and equality. For instance, the theories of feminism and agonistic pluralism could serve in solving the contradiction of the habermasian concept of open, participatory democracy, where everyone who is affected by the subject under discussion is entitled to have a say, with the current marginalization of refugees and their exclusion from public debates on refugee crisis, while they are the main actors and most interested in this issue. Such exclusion is justified under normative limits on the public debate like synchronization and similar interpretive frames, derived by Habermas' perception of public sphere and developed in mainstream studies of the European public sphere. As Calhoun stressed, "Although openness is basic to the ideology and theory of the public sphere, various forms of exclusion are basic to actually-existing publics. Gender exclusion has been widespread....Workers were largely excluded from the classical public sphere that Habermas analyzed. Immigrants may be in a similar position today" (Calhoun, 2011: 314).

## Conclusion

This paper, retraced the late twentieth century feminist perspective on public sphere, to analyze the European public sphere from this perspective and reveal its significant contribution. Inspired by the widen scope of analysis of the public sphere that the agonistic and pluralistic dimension of the reconsideration of the feminist standpoint provides, comparing to the strict application of the normative framing of the political realm and the deliberative public sphere, the paper argued in favor of agonistic pluralism as a feasible and plausible model of the European public sphere. As this model could render marginalized and weak publics in EU in the same status with the predominant ones, without seeking the utopian, and, more importantly, dangerous for democracy, assimilation of the first by the second.

## References

- Arendt, H. (1998). *The Human Condition*, 2nd edn. The University of Chicago Press.
- Bowring, F. (2011). *Hannah Arendt: A Critical Introduction*. Pluto Press.
- Brüggemann, M. and Kleinen Von Königslöw, K. (2007). Let's talk about Europe. Explaining vertical and horizontal Europeanization in the quality press. *TranState Working Papers* No 60: 3-4.
- Benhabib, S. (1992). *Situating the Self: Gender, Community and Postmodernism in Contemporary Ethics*. Polity Press.
- Benhabib, S. (1993). Feminist Theory and Hannah Arendt's Concept of Public Space. *History of the Human Sciences*, 6 (2): 97-114.
- Calhoun, C. (2010). The public sphere in the field of power. *Social Science History*, 34 (3): 301-335.

- Calhoun, C. (2011). Civil Society and the Public Sphere. In: M. Edwards (ed.), *The Oxford Handbook of Civil Society*. OUP.
- Cohen, J. (1995). Critical Social Theory and Feminist Critiques: The Debate with Jürgen Habermas. In: J. Meehan (ed.), *Feminist Read Habermas*. London: Routledge.
- Cutting-Gray, J (1993). Hannah Arendt, Feminism, and the Politics of Alterity: What Will We Lose If We Win? *Hypatia*, 8 35, 49
- Dietz, M. (1994). Hannah Arendt and Feminist Politics. In: L. P. Hinchman and S. K. Hinchman (eds.), *Hannah Arendt Critical Essays*. State University of New York Press, pp. 245-250.
- Dietz, M. (1995). Feminist Receptions of Hannah Arendt. In: B. Honig (ed.), *Feminist Interpretations of Hannah Arendt*. Pennsylvania State University Press.
- Ferree, M., Gamson, W., Gerhards, J. and Rucht, D. (2002). Four models of the public sphere in modern democracies. *Theory and Society*, 31 (3): 289-324.
- Fenton, J. and Fenton, N. (2003). New Media, Counter Publicity and the Public Sphere. *New Media and Society*, 5 (2): 185-202.
- Fenton, N and Downey, J. (2003). Counter Public Spheres and Global Modernity. *The Public*, 10 (1): 15-32.
- Fraser, N. (1990). Rethinking the Public Sphere: A Contribution to the Critique of Actually Existing Democracy. *Social Text*, 25/26: 56-80.
- Fraser, N. (2007). Transnationalizing the Public Sphere: On the Legitimacy and Efficacy of Public Opinion in a Post-Westphalian World. *Theory, Culture and Society*, 24 (4): 7-30.
- Habermas, J. (1974). The Public Sphere: An Encyclopedia Article (1964). *New German Critique*, 3: 49-55.
- Habermas, J. (1995). Remarks on Dieter Grimm's 'Does Europe Need a Constitution?' *European Law Journal*, 1 (3): 303-307.
- Harding, S. (2004). *The Feminist Standpoint Theory Reader: Intellectual and Political Controversies*. London: Routledge.
- Hartsock, N. (1985). *Money, Sex and Power: Toward a Feminist Historical Materialism*. Boston: Boston Northeastern University Press.
- Honig, B. (1998). Toward an Agonistic Feminism: Hannah Arendt and the Politics of Identity. In: J. B Landes (ed.), *Feminism, the Public and the Private*. Oxford: Oxford University Press.
- Karppinen, K. (2009). European Public Spheres and the Challenge of Radical Pluralism. In: I. Salovaara-Moring (ed.), *Manufacturing Europe Spaces of Democracy, Diversity and Communication*, Nordicom.
- Laclau, E. and Mouffe, C (2001). *Hegemony and Socialist Strategy: Towards a Radical Democratic Politics*. Verso.
- Lane, M. (1983). The Feminism of Hannah Arendt. *Democracy: A Journal of Political Renewal and Radical Change*, 3(3): 107-18.
- Lubenow, J. (2012). Public Sphere and Deliberative Democracy in Jürgen Habermas: Theoretical Model and Critical Discourses. *American Journal of Sociological Research*, 2(4): 58-71.
- Mouffe, C. (2000). Deliberative Democracy or Agonistic Pluralism. *Political Science Series*, 27(4): 459-487.
- Pitkin, H. (1981). Justice: "On Relating Private and Public". *Political Theory*, 9 (3): 327-352.
- Rasmussen, T. (2016). *The Internet Soapbox: Perspectives on a changing public sphere* Universitetsforlaget.
- Rich, A. (1979). *On Lies, Secrets, and Silence: Selected Prose 1966-1978*. Norton..
- Tănăsescu, G (2014). Habermas' Normative Model of Public Sphere in the Current Debate of the European Public Sphere. *SEEJPS*, 2.
- van de Steeg, M. and Risse, T. (2010). The Emergence of a European Community of Communication: Insights from Empirical Research on the Europeanization of Public Spheres. *KFG Working Paper No. 15*.
- van der Tuin, I. (2016). Feminist Standpoint Theory. In: N. Naples (eds), *The Wiley Blackwell Encyclopedia of Gender and Sexuality Studies*. Wiley-Blackwell.
- Wimmer, J. (2005). Counter-Public Spheres and the Revival of the European Public Sphere. *The Public*, 12 (2): 93-109.
- Winant, T. (1987). The Feminist Standpoint: A Matter of Language. *Hypatia*, 2 (1): 123-148.

**TOPIC 9: PUBLIC POLICIES IN EDUCATION, HIGHER EDUCATION & TRAINING**

## **9.1. Greece as an International Hub for Higher Education: Opportunities, challenges and recommendations for Greece in the International Student Market (ISM)**

*Cheryl Novak<sup>1</sup>*

### **Abstract**

The level of internationalization of higher education institutions in any country is a key indicator of the degree of competitiveness of its institutions. While there are many qualitative elements to be considered when assessing the level of internationalization of any institution, the most widely accepted and quantifiable element is the International Student Market (ISM). This short intervention offers information about the current state of internationalization of higher education institutions in Greece, viewed within the framework of the International Student Market (ISM), and presents a view on the opportunities, challenges and recommendations for Greece on how it can move towards increasing its share of the ISM, thus improving the level of internationalization of the country's institutions, the rankings of its institutions, and the promotion of economic growth in the country through higher education.

**Keywords:** Higher Education, International Student Market, Training

### **Introduction**

For the past decade, academics and experts have promoted the idea of Greece reclaiming its former status as an international hub for higher education, citing its rich history, geographical location, and well trained academics as competitive advantages. This intervention argues that now, more than ever, there is a possibility for a modest version of this dream to be achieved, pending that Greece develops a national internationalization strategy and takes necessary related actions. The concept of “internationalization” of Higher Education includes both qualitative and quantitative elements, the former of which may be prone to debate by policy makers, university ranking systems, think-tanks and more. As a result, this presentation focuses on the most widely accepted indicator of on the level of “internationalization” of higher education, and is known as the International Student Market (ISM). The ISM is the market formed by the convergence of: national policies that promote and impact the flow of international students, students willing to study outside of their home country, and by universities and education institutions that are willing to host international students throughout their studies. The ISM measures the inflow and outflow of students who choose to undertake all or part of their degree programs outside of their home country (including degree programs, study abroad, non-formal learning and internships).

### **Main issues**

In 2017, the global ISM was valued at 300 billion USD and comprised of 5 million students per year studying outside of their country, and is expected to grow to 8 million students annually over the next decade (ICEF, 2018). The top three countries leading the ISM are all English speaking countries, as the English language is the most sought after language of instruction in the ISM, and their market share accounts for just under half

---

<sup>1</sup> MSt, University of Cambridge.

of the total ISM. The market leader is the United States of America (USA), with 1 million incoming students per year, the United Kingdom (UK) with 400,000 students and Australia with 350,000 students (OECD, 2017). ISM data reveals that incoming students are key economic growth drivers, with 2014 figures from the Association of International Educators (NAFSA) in the USA purporting that international students contributed more than 30 billion USD to the USA's economy. Meanwhile, economic figures from the United Kingdom are calculated differently and thus do not offer a clear comparison to the USA, but for the sake of illustration, incoming international students are considered to contribute an estimated 3.2 billion GBP each year to the UK's economy, with each cohort expected to contribute another 3.2 billion to the UK economy over 10 years in the form of social security contributions (TopUniversities, 2019). It is not surprising, therefore, that both the U.S. and the UK have clearly formulated national strategies for the promotion of the internationalization of higher education in their countries. However, current political developments in both the U.S. and the UK are disrupting the flow of international students to both countries and are precipitating a "shake-up" in the ISM. The conflict between political agendas and the needs of students and institutions present several cautionary tales and opportunities for Greece, which will be discussed shortly.

As previously mentioned, the number of international students coming into a country and to its universities is not only important for economic growth, but is a key figured used by university ranking systems, such as QS, Times Higher Education (THE), Shanghai, and TopUniversities, when determining the overall score of a university. For example, in Times Higher Education (THE) ranking methods, THE notes that the "international outlook" of a university accounts directly for 7.5pct of the score for a university, and that the student bodies of the top-10 ranked universities by THE are comprised of 20-56 pct international students. THE notes in its September 2019 rankings that the international component of rankings also includes factors such as international staff, citations in international journals and more, but states that it focuses on the international student body because "the ability of a university to attract undergraduates, postgraduates and faculty from all over the planet is key to its success on the world stage" (THE, 2019).

The incumbent political party of Greece, New Democracy, has stated in its campaign platform that it aims to make Greece an "international education center", but as of autumn 2019, it has not formulated its policies, nor its strategy for the internationalization of higher education, likely on account of the numerous modifications that must be performed to the public higher education system of Greece. A look at Greece in the ISM reveals that it holds a mere 0.7 pct of the ISM, which translates to approximately 27,500 foreign students hosted in 2015, 47pct of whom were from Cyprus, 28 pct from Albania, 28pct from the rest of the world, including 4000 study abroad students from the U.S. (National Bank of Greece, 2017). There is clearly a large gap to be filled between Greece and the leaders of the ISM, in order for the country to become an international hub for higher education. A look at the ten Greek universities appearing in the recent 2020 Times Higher Education reveals that a the universities' student bodies are comprised of a mere 1-10 pct of international students. While there are estimates about the total contributions of the current international students to Greece's economy, the 2017 National Bank of Greece report on "Turning Greece into an educational hub" projects that if international

students were raised from current levels to 110,000 students per year, annual GDP growth could be boosted by 1.1 percentage points in the first decade (National Bank of Greece, 2017). More importantly, the report states that it would transform Greece's growth model from a service economy and lead to societal transformation as the country could become a knowledge-based economy and international hub for education and innovation, with links to the market.

While Greece appears to be starting from the baseline in terms of engaging with the ISM, timing appears to be more auspicious than in the past, and presents opportunities that may be used to the country's advantage. First and foremost, New Democracy has expressed its political will to internationalize institutions and Minister of Education Niki Kerameus, on her recent visit to the New York, visited several important institutions to discuss national partnerships to increase the inflow of international students, such as the Institute of International Education. Secondly, there is now positive sentiment around Greece as it has exited the bailout program, has political stability, is perceived as a safe country, and has political support from key players in the ISM known for sending students, such as the USA. A third and important element not to be overlooked is the prominence of the Greek diaspora. With an estimated 22,000 university professors of Greek origin teaching outside of Greece and with many of these holding top leadership positions, there are many bridges than can be formed not only for student mobility, but also for professor mobility, curriculum development and joint publications, which are all important elements of internationalization.

Although seemingly evident, Greece's status as a member of the European Union is a key advantage for increasing its share of the ISM, particularly as it is granted access to EU funding for student mobility and moreover on account of the fact that the UK, a leader in the ISM, may soon be leaving the EU. The probability of BREXIT is already negatively impacting the UK's share of the ISM and encouraging international students to consider alternative study destinations. The current disruption in the ISM is the greatest opportunity for Greece, as unfavorable immigration policies in the USA have led to a 6.6pct decrease in international students going to the USA (ICEF, 2018). As a result, new, regional ISM players are gaining a bigger share of the total market as they are also newly offering degree programs in the English language and promoting competitive tuition policies. ISM analysts' attribute this shift to the willingness of students to consider new destinations with perceived political stability and friendliness to foreigners, and also the openness of student placement organizations, study abroad program organizers and student aggregators to explore new partnerships to meet students' changing needs.

In order for Greece to take advantage of these opportunities and increase its share of the ISM, there are several key challenges that the country must address. First off, there is insufficient and irregular data on Greece's ISM. This very practical issue impedes policy makers and analysts from constructing market-based recommendations and strategies on how to further engage with the ISM. Moreover, key reports from agencies such as the Hellenic Quality Assurance and Accreditation Agency are often not available in the English language, which is a challenge for foreign placement organizations to understand how to engage with Greece-

based institutions. To illustrate this point, the annual reports published in the English language by OpenDoors on the ISM in the USA include detailed profile information on both incoming and outgoing students to/from the USA, the programs that students participate in, the duration of their studies, the number of students at each host institution and more. Greece's irregular reports often consist of approximations and are significantly less detailed.

Next, Greek public universities face key governance issues, which hamper their competitiveness. The institutions lack sufficient autonomy to interact with the highly competitive and fluctuating ISM. Universities need to be flexible and responsive when engaging with the ISM in order to identify key interests, establish strategies and to ensure the sustainability of programs, particularly in regards to tuition and scholarship policies. The need for "power of the purse" also hinders universities' ability to offer attractive and market-oriented international student services, such as quality dorms and food services, student activities, psychological support, and more. This is also connected to the need for each institution to determine its competitive advantage and to establish undergraduate and postgraduate programs in the English language that can be competitive and attractive to the international market. As is well known, Greece will offer its first undergraduate program in the English language at a public university in September of 2020. As most international students are looking for programs in English, and study abroad students usually travel in the second or third year at the undergraduate level to programs in the English language, Greece cannot expect to dramatically increase its share in the ISM until additional attractive programs are offered in English.

The final two challenges for Greece are of legal and political nature, with wide-ranging implications. Firstly, Article 16 of the Greek Constitution, which states that no private higher education institutions can be established in Greece, is anachronistic and has created a schism between public and "other" higher education institutions in the country. This schism weakens the Ministry of Education's ability to mobilize actors in Greece's higher education sector which possess many years of experience hosting international students, such as Degree, College Year Athens, and other non-profit education providers. A unification of public and other would enable the Ministry to exploit synergies and market all of the country's higher education offerings to foreign ISM institutions. On the public policy side, as there is no coherent national policy on the internationalization of higher education, there are cumbersome and bureaucratic policies in place, influenced by Article 16, that discourage international students from considering Greece, such as Greece's student visa policy. The ISM data reveals that the ease of obtaining a visa is a key consideration of international students when selecting a school. If a student is confronted by "unfriendly" visa policies and procedures, students will likely aim to minimize their risk and opt for a different host country.

The implications, risks and costs related to conflicting national policies on immigration, security and internationalization of higher education can be high. For example, the University of Illinois in the USA was the first university in the world to take out an insurance policy to hedge against the risk of a decrease in the number of Chinese students attending the university on account of President Donald Trump's trade war with

China. At a cost of 424,000 USD annually, the university's insurance policy is valued at 61 million USD, which is the revenue that the university derives from Chinese students attending its business and engineering schools (Robert, 2019). In Greece, the country's visa policies detract third country nationals from education providers because the student visas offered are not in line with the needs of the market. Data reveals that the majority of the world's study abroad students originate from the USA and these students study outside of their home country for a period of six months. Greece, which is in the early phases of trying to attract U.S. students, offers a three-month student visa and requires students to apply for a residency permit upon arrival to Greece, which means that the students must find a lawyer and pay legal expenses upon their arrival. There is no guarantee of acceptance, so a student may be forced to leave Greece halfway through their six-month study abroad program. In the USA, early dismissal from a program could mean that a student would not obtain the credits they need to complete the academic semester. Such a delay could cost a student an additional semester's worth of tuition, which is on average 30,000 USD. International study abroad students from the USA may opt for a program in a different country with more favorable visa terms in order to mitigate risk. The result for Greece is a negative impact on the level of internationalization of the student body, loss of revenues for the institution, and less tax and financial inflows to the local community where the international student will be based.

## **Conclusions**

In order to move towards Greece increasing its share of the ISM and further internationalizing its institutions, a review of best practices present by the ISM leaders reveal several key areas for Greece to work on. First off, Greece must develop a comprehensive national policy on the internationalization of higher education, which includes and mobilizes all actors, both public and private, that service the field of higher education and participate in Greece's ISM. In order to formulate a comprehensive national policy on internationalization, it is important for Greece to first understand the will and capacity of its institutions to attract more students, to understand the complications, identify growth areas (such as degree programs that should be offered in the English language) and set reasonable ISM milestones and growth targets. A comparison of national policies reveals the importance of having a country's educational objectives aligned with its goals related to economic development, national interests, security concerns and societal progress. Second, once a policy is formed, the Ministry of Education will require a strategic marketing and communication campaign to promote the country as "open for education". Greece must improve its visibility as a destination for higher education, formulate strategic partnerships with key mobility institutions such as the International Education and Generation Study Abroad, and encourage institutions to attend international student fairs outside of the country. Third, Greece must ensure that it obtains and maintains the publication of reliable and regular data on the ISM, and publish it in Greek and English for national and international actors to utilize. Data on program offerings, tuition and living costs will help mobility coordinators and aggregators ascertain where they can best channel their international students.



In conclusion, there are many developments in the ISM which present new opportunities for Greece to increase its share of the market and thus improve the level of internationalization of its education institutions and promoting economic growth. Achieving this long-term goal will be dependent upon Greece first developing a comprehensive national policy on the internationalization of higher education, and by mobilizing, promoting and utilizing all of Greece's higher education actors to formulate and implement market-based strategies designed to attract and keep students from throughout the world at Greece's higher education institutions. Although at the very beginning of its journey, Greece can surely achieve the status of being a hub for international students, and protagonist for higher education in the greater region.

## References

- American Council on Education's Center for Internationalization and Global Engagement (2015). Internationalizing Higher Education Worldwide: National Policies and Programs. Available at: <https://www.acenet.edu/Documents/National-Policies-and-Programs-Part-1-Global.pdf>
- Eurostat (2019). Statistics for Tertiary Education." Eurostat statistics explained, 18 September. Available at: [https://ec.europa.eu/eurostat/statistics-explained/index.php?title=Tertiary\\_education\\_statistics/el#CE.A3.CF.85.CE.BC.CE.BC.CE.B5.CF.84.CE.BF.CF.87.CE.AE\\_.CE.B1](https://ec.europa.eu/eurostat/statistics-explained/index.php?title=Tertiary_education_statistics/el#CE.A3.CF.85.CE.BC.CE.BC.CE.B5.CF.84.CE.BF.CF.87.CE.AE_.CE.B1)
- Frank, R. (2019). "University discovers a solution to possible drop in Chinese students: Insurance". CNBC, 6 September 2019. Available at: <https://www.cnbc.com/2019/09/06/university-discovers-solution-to-drop-in-chinese-students-insurance.html>
- Hellenic Colleges Association (2019). Data available at: <http://www.ellinikakollegia.gr/>
- Hellenic Quality Assurance and Accreditation Agency (2017). Report on the quality of higher duration in Greece. July 2018. Available at: [https://www.adip.gr/sites/default/files/pages/17/142-hqa\\_report2017.pdf](https://www.adip.gr/sites/default/files/pages/17/142-hqa_report2017.pdf)
- ICEF (2018). Up and down the table: Growth trends across major international study destinations. UK: ICEF Monitor, 29 August 2018.
- IIE (2018). Open Doors Data: US Study Abroad Data from the 2018 Open Doors Report. IIE. Available at: <https://www.iie.org/Research-and-Insights/Open-Doors/Data/US-Study-Abroad/Destinations>
- Larmer, B. (2019). "One of America's most vital exports, education, never goes abroad, but it still faces threats." New York Times, January 3, 2019. Available at: <https://www.nytimes.com/2019/01/03/magazine/one-of-americas-most-vital-exports-education-never-goes-abroad-but-it-still-faces-threats.html>
- Mylonas, P. (2017). Turning Greece into an Education Hub. National Bank of Greece Sectoral Report, 2017. Available at: <https://www.nbg.gr/greek/the-group/press-office/e-spot/reports/Documents/Education.pdf>
- New Democracy (2019). New Democracy program. September 2019. Available at: [www.nd.gr](http://www.nd.gr)
- OECD (2017a). OECD Education Policy in Greece A Preliminary Assessment 2017. Paris: OECD Publishing. Available at: <http://www.oecd.org/education/Education-Policy-in-Greece-Preliminary-Assessment-2017.pdf>
- OECD (2017b). *Education at a Glance 2017: OECD Indicators*. Paris: OECD Publishing.
- OECD (2018). *Education for a Bright Future in Greece: Reviews of National Policies for Education*. Paris: OECD Publishing.
- OECD (2019a). Higher Education needs to step up efforts to prepare students for the future. Paris: OECD. Available at: <http://www.oecd.org/education/higher-education-needs-to-step-up-efforts-to-prepare-students-for-the-future.htm>
- OECD (2019b). OECD Skills Strategy 2019. OECD, May 2019. Available at: <http://www.oecd.org/greece/Skills-Strategy-Greece-EN.pdf>
- Sanchez-Serra, D. and Macaroni, G. (2018). Foreign students' tuition fees are a double-edged sword. University World News, 23 February 2018. Available at: <https://www.universityworldnews.com/post.php?story=20180220142151532>
- Shanghai Ranking (2019). Academic ranking of world universities 2019. Available at: <http://www.shanghai ranking.com/World-University-Rankings-2019/Greece.html>
- The Wall Street Journal (2019). How international students are changing US Colleges. Available at: <http://graphics.wsj.com/international-students/>

- THE World University Rankings (2020). Methodology. THE: September 2, 2019. Available at: <https://www.timeshighereducation.com/world-university-rankings/world-university-rankings-2020-methodology>
- Top Universities (2019). How Much Do International Students Bring to the UK Economy? Available at: <https://www.topuniversities.com/student-info/university-news/how-much-do-international-students-bring-uk-economy>
- UNWTO (2019). UNWTO World Tourism Barometer (English version). UNWTO: 17 (2): 1-40, May 2019. Available at: <https://www.e-unwto.org/doi/pdf/10.18111/wtobarometereng.2019.17.1.2>
- World Bank (2016). Education Statistics (EDStats). Available at: <http://datatopics.worldbank.org/education/country/greece>
- Younger, J. (2018). Attracting top international students helps all of us here's why it matters." Forbes, 14 December 2018. Available at: <https://www.forbes.com/sites/jonyounger/2018/12/14/attracting-top-international-students-helps-all-of-us-heres-why-it-matters/#4403b45e2f7a>

## 9.2. European educational governance: policy learning and the teaching profession

*George Pasiás<sup>1</sup>, Antonia Samara<sup>2</sup>*

### Abstract

During the last decades and especially after the Lisbon Strategy, issues of governance in education are crucial. EU has gradually mastered soft governed areas, mainly through the application of the Open Method of Coordination. Today, we are witnessing the overall domination of corset policies in education, in which the various educational partners, from nation states to institutions, seem to be willing to fit. On the other hand, a new notion in EU educational discourse has prevailed during the last decade, namely that of competences, as an idea that includes knowledge, skills and attitudes in a dynamic of lifelong learning. The paper explores ideological perspectives of the competence society as it is perceived through EU papers of the last decade, as well as the way which this competence society is built through alignment. In this context we link it to the creation of the “competence for self-government” of educational organizations and even education professionals, through setting goals, planning action, self evaluation, participating in networks and measuring achievement.

All the above are implemented from the national policy level to the level of the school. Therefore we try to explore the implementation of EU governance inside school, with the teachers playing a central role. We focus on projectization in education as a means of implementing educational change. For this to be realized we are investigating the role of teachers, namely the role of teachers as agents of change and of policy implementation via projectization, which is possible through modes of evaluation, self evaluation, specific target setting and performativity. These all set new competences for teachers and call for the building of a new lifelong learning teacher in a school that functions as a learning organization. We conclude by arguing that such education professional can also understand, interpret and reflect on educational policy, and act upon it, by customizing practices to the specific needs and capabilities of the national/local environment, the school community and his/her students accordingly.

**Keywords:** education governance, competencies, open method of coordination, projectization, lifelong learning teacher

### Introduction

In this paper, we attempt to critically analyze and comment the concepts of “educational governance” and “policy learning” as key ideas in the present discourses and practices of the European education policy. We argue that the two concepts represent a diagram of new “power - knowledge” relations, both at the European and the national level, closely connected with a “paradigm shift” as well as the making of a new “educational subject”. The paradigm shift is associated with a changing mode of “soft governance” articulated by the Open Method of Coordination procedures and practices. Respectively, the new “educational subject” is associated with a “competence-driven” model of an “entrepreneurial self”, which stems from the market-driven and managerialist “discourses” of quality, efficiency, effectiveness and competitive performativity.

### The paradigm shift: changing the mode of governance

---

<sup>1</sup> Professor, National and Kapodistrian University of Athens, Greece.

<sup>2</sup> PhD, National and Kapodistrian University of Athens, Greece, Email: [asamara@primedu.uoa.gr](mailto:asamara@primedu.uoa.gr)

During the last decades there has been a “paradigm shift” at the foreground of the European education policy debate, which is characterized by the transition from methodological nationalism to a plurality of “new examples” of educational borrowing and lending (Auld & Morris, 2014), emphasizing in “policy transfer” (Rappleye, 2012), “policy shape-shifting” (Klerides & Kotthoff, 2015) and “policy learning” (Alexiadou, 2014). The paradigm shift is associated with a Governance turn, i.e. the transition from the concept of 'government' / 'governing' to 'governance', organized by forms of 'soft governance' and 'governance / steering at a distance' (Alexiadiou, 2007; Lawn & Grek, 2012). The term 'governance' refers to the coordination, cooperation and the existence of a variety of mechanisms operating on multiple scales without the existence of a wider political power. Governance is seen as a new political process associated with the formation, operation and exercise of power by international and transnational government structures connected with self-organization and intra-organization responsibilities and capabilities (Rhodes, 1997).

These structures contribute to the development of networks in the international arena that are characterized by interdependent relationships, of 'know-how' exchanges, of the establishment of independent operational rules and the significant autonomy from the States' power. Subsequently, it is about a 'governance without government' model, implemented through formal and informal rules and regulations of political and social processes, which also expresses the ability of international organizations to develop, shape and influence policy-making and policy directions at the international level (Rosenau & Czempiel, 1992; Martens & Balzer, 2004). Some key features of this changing the mode of governance are, among others:

- a. Epistemic communities possess a dominant role in this way of governing (Haas, 1992). Networks of experts / technocrats, based on specialized knowledge, focus on problem solving procedures (Normand, 2016) and they usually suggest “soft governance” evaluative and assessment measures and practices, preferring common rules-based options rather than exercising power (Martens et al., 2010; Grek, 2010).
- b. The 'soft governance' model is closely connected with the strengthening of 'quality assurance' mechanisms as well as 'steering / governance at a distance' procedures (Alexiadiou, 2007; Lawn & Grek, 2010).
- c. The educational area is running through a 'policy by numbers' paradigm based on indicators, evidence-based results and benchmarking (Room, 2005). It draws on the International Economic Organizations (OECD, WB, IMF, WTO) discourses and practices, accompanied by the dominance of technocrats (expertise, eurocrats) and the prevailing of an economic-managerial ideology emphasizing on the techno-preneurial rationale (Mahon & McBride, 2009; Normand, 2010; Grek, 2013). The above paradigm promotes an 'audit culture', a 'performance and accountability nexus', a 'governance by numbers' framework, legitimized by the epistemic community and controlled by the networks of technocrats (Shore, 2008; Grek, 2008; Lingard et al., 2012).
- d. The 'paradigm shift' is based on and taking place in the neoliberal hegemony and the requirements of a 'competence based/driven society' (Mulder 2017). Neoliberalism is not perceived just as an economic doctrine, an ideology of a "free" capitalist economy. It is mainly considered as a political rationale of governance that imposes the modern biopolitical control, aiming at the making of a self-disciplining and self-regulating subject

(political, social, educational) (Lazzarato, 2009; Dardot & Laval, 2013; Brown, 2015). In this sense, ‘governmentality’ and ‘performativity’ constitute the key analytical-interpretive terms of the neoliberal bio-power, closely connected with the making of the ‘entrepreneurial self’ (Peters et al., 2009; Singh, 2015; Brockling, 2015).

### **b. The Open Method of Coordination: a mode of Soft governance in the EU context**

The Open Method of Coordination (OMC) as a policy learning discourse is a policy instrument that aims to improve the effectiveness and to enhance the coordination between EU member states. The Lisbon European Council (23-24/3/2000) defined the Open Method of Coordination “as the means of spreading best practice and achieving greater convergence towards the main EU goals”. Its main features are:

- “fixing guidelines for the Union combined with specific timetables for achieving the goals which they set in the short, medium and long terms;
- establishing, where appropriate, quantitative and qualitative indicators and benchmarks against the best in the world and tailored to the needs of different MS and sectors as a means of comparing good practice;
- translating these European guidelines into national and regional policies by setting specific targets and adopting measures, taking into account national and regional differences;
- periodic monitoring, evaluation and peer review organised as mutual learning processes” (European Council, 2000, par.37).

The Open Method of Coordination (OMC) is a policy process that aims to improve the effectiveness and coordination of a range of policies in the European Union by using ‘soft law’ as opposed to traditional law. The OMC creates a complex system of ‘multi-level governance’ where informal normative pressures and agenda setting attempt to direct reforms in education policy areas where the EU has no competence to legislate (Alexiadou 2014).

The Europe 2020 strategy advocates a “strong governance framework” and a “more focused country surveillance” that builds on the various mechanisms of the Open Method of Coordination (OMC). The Council and the Commission had emphasized the significance of the coordination process for national education reforms, and the need to “strengthen horizontal cooperation”, to share good practices among member states and to promote “further opportunities for policy learning”.

‘Policy learning’ is a fundamental part of the OMC governance strategic in education. It refers both to ‘mutual learning’ as well as to the wider issue of ‘policy transfer’ through ‘best practices’. It is a mode of governance based on guidelines, benchmarks, peer pressure which suggests that the policy ‘paradigms’, ‘styles’, ‘ways of doing things’ and shared beliefs and norms can be ‘incorporated in the logic of domestic discourses, identities, political structures and public policies (Alexiadou, 2014:125).

The development of the OMC has gained particular influence in shaping the convergence of national education systems (Alexiadou et al, 2010). The implementation of the OMC in education aims not only to the Europeanization of national policies but, mainly, to the refreshing/remodelling of the national way of thinking in the management of education systems. The OMC was clearly designed to bring about political results as well as to act as a process of improving policy management (Hodson & Maher, 2001; Haahr, 2004).

The Lisbon Strategy has made it clear that 'benchmarking' will play a central role in the development and implementation of learning and governance policies in the European education area. Selecting indicators, setting criteria, standards and evaluating processes indicates the establishment of an 'external' audit, monitoring and compliance framework aiming to controlling crucial and sensitive areas of Member States' social and educational policies (Pasias, 2005).

In the mid -00s the Commission had, for the first time, implemented the OMC in the European education policy by setting up eight clusters in order to strengthen the cooperation between Member States (European Commission 2006). The clusters were based on the OMC methodology through Peer Learning Activities (PLAs) aiming to the enhancement of mutual learning and the “best practices” dissemination and diffusion (Alexiadou 2007:104). As a result of the OMC successful implementation during the 2008-09 period, the Council of the EU reaffirmed the significance of the coordination process for the EU 2020 education strategy. In this perspective, and with a view to greater flexibility and cooperation, the Council determined a new OMC framework including : a) Work cycles (3 years period), b) Priority areas, c) Mutual learning initiatives, d) Dissemination of results, e) Progress reporting at the end of each cycle, f) Monitoring of the process and its outcomes (Council of the EU, 2009).

In 2012 the Commission proposed “Rethinking Education” by investing in skills development which are “essential to boost growth and competitiveness and to determine Europe's capacity to increase productivity” (European Commission, 2012:2). Moreover, it reshaped the organisational framework around policy learning. The ‘clusters’ have been replaced by Thematic Working Groups (TWGs) as part of the EU policy on cooperation processes in education and training supporting common policy objectives. The TWGs support policymaking at the EU and national levels, and offer a forum for the exchange of experiences and best practices on ways to address the key challenges facing education and training systems (Alexiadiou, 2014:128).

In the context of the “E&T 2020” programme, changes in OMC discourse and practices are evident: the OMC remains a key methodological tool for achieving new goals and is enriched with a range of technocratic tools and processes (indicators, benchmarks, progress reports, dissemination of results) which will ensure the success of the new priorities with particular emphasis on measuring, recording, monitoring and evaluating procedures and actions. The new OMC framework may be characterized as more technocratic, more target-setting, more strictly and disciplinary - in a way more 'mature' as it is fueled by the experience gained and therefore appears to be more ready to fill the gaps that emerged from its implementation in the previous period.

In August 2015, the Commission announced new policy priorities for the period 2015-2020, emphasizing on education and training policy being based on evidence-based practices, such as “Strong analytical evidence and progress monitoring, streamlining and rationalising reporting, peer learning activities, dissemination of good practices and lessons learned, using international evidence” (European Commission, 2015). According to the Commission, the existence of a credible basis of documentation and in-depth analysis is key to the development of a converging policy on education and training. A typical example is the annual monitoring reports on the indicators and benchmarks of the Education and Training 2020 Strategic Framework. In support of the above policies, the Commission cooperates with research networks (Eurydice), research bodies (CEDEFOP, CRELL) and international organizations (OECD).

### c. ‘Projectisation’ as a practice of learning

The OMC (as policy learning process) is clearly based at the project philosophy, development and implementation process. OMC is a projectisation process! It is a mode of governance fully based on the “project” philosophy, content and implementation. Projects are sets of coordinated activities with a set start and end point, which are implemented by individuals and organizations, pursue specific goals, use specific resources, based on guidelines, targets, timetables, standards, indicators, benchmarks, monitoring, evaluation, peer pressure... They also attempt to manage mismatched elements such as networking, teamwork, negotiation and communication with control, quality assurance, accountability and performativity.

They produce a new rationale of thinking and action (a new ‘euroeucracy’?) that transcends the principles, rules, techniques and procedures of governance while at the same time the ‘knowledge worker’ is being transformed into a ‘project worker’! Interdisciplinarity, heterogeneity, diversity, reflexivity, control and accountability are key features of knowledge production within the “projectisation process” which imposes its own theories, strategies and practices. Moreover, the experiences gained through this process are transformed into personal as well as collective skills/competences that are utilized and transferred to new social and educational contexts (Stratou, 2018: 94-102).

Nowadays, almost every educational organization is involved in some kind of ‘projectisation process’ (Brunila, 2011). ‘Projectification’ and ‘Programmification’, as key signifiers (Maylor et al., 2006), permeate both the EU official education discourse as well as the school reality. The project-based work as a mode of learning operates at two levels: a) at the european/ national level through EU programs and b) at the school level projects through interdisciplinary/thematic courses. Projectisation is an old form in European education policy promoting Europeanization (mutual learning & policy transfer) through European programs (Arion, Socrates, Leonardo, Erasmus, Comenius, Minerva, E-twinning, LLL, Erasmus+). Projectisation is also an old form/mode in school thematic learning (mutual learning, communication, school networks, teacher & student mobility & exchanges) (Kovach & Kucerova, 2009). Project-based activities promote decentralization and autonomy and represent a form of new governance, because they succeed into effectively bringing individuals, groups, organisations, enterprises and state officials together, in order to solve educational problems (soft

governance) (Packendorff & Lindgren, 2014). Projects can be seen as tools for the promotion and development of knowledge policy, as they are knowledge produced, evaluated and disseminated as ‘best practice’ at multiple levels of influence (individual, school, national, regional, European). Into the ‘projectisation’ discursive field, key concepts such as learning, collaboration, mutuality, competitiveness, innovation, entrepreneurship, flexibility are transformed from ‘empty/ floating’ signifiers to ‘nodal’ signifiers radically affecting the EU's policy transition from government to governance (Stratou, 2018: 139-140).

Projectisation (in Foucault terms) is a form of productive and disciplinary power (Brunila, 2011:421). It has a discursive power which connects the concepts of governance and governmentality. As a form of governance, it is operated and self-organized through transnational networks adapted to modern needs (Grabher, 2004). As a form of governmentality, it aims to the making of a new subjectification through the ‘project-based’ learning. It requires/demands/ promotes a new (competence-driven) subject, and shapes the actions of the performative educational subjects (learning to learn, cooperation, dispositions to change, innovation, self control, self improvement) (Gillies, 2008). The rationality of Projectisation is also presented as the new common sense of a ‘policy by numbers’ regime, directly related with performative and audit technologies and mechanisms (target setting, scheduling, appraisal meeting, benchmarking, inspection, report writing, database updating, dissemination of results, peer reviews, etc.) (Strathern, 2000, Ball, 2003). In this sense, OMC and Projectisation constitute new mechanisms of eEuropean educational governance aiming at the “techno-preneurial” restructuring of the teaching profession (Ozga et al., 2011).

#### **d. A new teacher’s identity in a “competence-driven” society**

DuringThe last decades, new forms of “*school-based*” processes and practices have radically influenced the shifting paradigm in education governance (Hargreaves & Fullan, 2012; Marsick, Watkins, & Boswell, 2013).

The conception of the school as a “*learning organization*” and of teachers as a “*learning community*” or a “*community of practice*” constitutes a notable alternative significance to modern educational 'discourse' and practices; it draws from ‘regimes of truth’ (knowledge based economies, competence-driven society, education governance, quality in education) and interconnects with crucial concepts of the educational process such as: school autonomy, educational administration, school self- evaluation, school accountability, quality, effectiveness and improvement, teachers’ professional development etc (Kools & Stoll, 2016; European Commission, 2018).

The transformation of a school into a ‘learning organization’ is directly connected with structural and profound changes in the school's culture and the teachers’ professional profile. In the schools as 'learning organizations', teachers are being transformed into ‘professional learning communities’. The school unit is based on open, democratic and cooperative practices and is governed by a permanent culture of change, innovation and new learning, which radically influences various forms of school systemic learning, student learning and teacher learning. In this sense, the nature of this transformation takes time and requires radical changes in the teachers'



qualifications framework in order to make them capable to promote/develop systemic and educational changes effectively (Stoll & Louis, 2007; Harris & Jones 2010).

A critical approach to the teachers' professional profile, to continuing professional development, to teacher's identity is inseparable from concepts such as "*competence*" and '*qualifications*'. 'Competence' is a complex, exaggerated term that is defined, analyzed and evaluated only if it is placed within a certain framework (educational, employment, social, etc.). It is a dynamic concept which is not limited to a form of acquired knowledge but is established, ratified, distributed, disseminated, extended to all the elements (goals, content, means, processes, results) of a given situation, relationship or practice (OECD, 2005; Council of the EU, 2006).

Placing 'competences' as the organizing principle of a modern school framework, means that education policy goes beyond traditional perceptions of teaching and learning (Jessop, Fairclough & Wodak, 2008). The content of education is gradually transformed, new taxonomies of knowledge and lifelong learning processes have appeared, a new status of 'power-knowledge' relationships in education has been established and the role of the teachers has definitely changed. The concept of competence emerges as a fundamental signifier between economy and education related, among others, with: a) the changing human capital landscape (competitiveness, flexibility, employability) (Burton-Jones, 1999), b) the transition from the social capital/reproduction theories to the neo-liberal regime (Bonal, 2003), c) the transition from 'visible' to 'invisible' pedagogies and from a 'knowledge-based' to a 'competence-based' system emphasized at new forms of governance and accountability technologies (Singh, 2015).

The hegemony of the neoliberal governance through new public management policies and procedures) has a profound effect on prevailing new modes of teaching and learning, characterized by the following:

- the framework of "*education*" becomes "*lifelong learning*"
- 'teaching' is transformed into '*learning*' and finally into '*learning*'
- the emphasis on "*inputs*" is transferred to "*outputs*", such as measurable results and certified knowledge
- new public management rationale infects school organization and administration
- '*knowledge*' is transformed into '*competences*'
- 'equality of opportunity' and 'equality / equity' is transformed into '*accessibility*' and '*adaptability*'
- "*work*" is transformed into "*trainability*" and "*employability*"
- 'active citizenship' into '*performativity*'.

Consequently, new flexible learning environments degrade, impair, deconstruct and replace the traditional mechanisms of the school knowledge production, transmission and dissemination. The new "learning" must emphasize on the "knowledge workers". Research data have pointed on / out a fundamental "knowledge gap" between academic and cognitive skills and "workplace competences", focusing on the so-called "knowledge

workers” who can/should be adapted more effectively in the “knowledge economy” requirements/demands indicated by crucial changes/influences in the digital world and technoscience (Ulluorta & Quill, 2009). New learning processes must be directly linked to the goals and skills imposed by digital technologies and by the immaterial knowledge based production, consumption and communication processes of the “cognitive capitalism” (Peters & Reveley, 2012). In that order, the school system should be able to transform the various (social, cultural, educational) inputs into the economically desired results. Emphasis is now placed on learning outcomes, outputs, learning products, qualifications. The desired “Knowledge” is a notion of utilitarian, measurable, manageable and commercialized knowledge.

In this sense, the “governmentalization of learning” has been considered as a key dimension of the education/labor “place shifting”. The “governmentalization of learning” draws directly from the ideotypes of the “competence based society” and “new learning”; it is founded on the transformation of the concept of “learning” to “l’earning”, which refers to capitalize on learning, a concept which interprets the learning as “capital” as well as an investment”, “learning that can and should be manageable and at the same time *‘employable’*” (Simons & Masechelein, 2008).

Furthermore, the “governmentalization of learning” deeply affects the school community as a whole. It indicates a new framework for student competences and for teacher qualifications in a school that is transformed by a managerial/technocratic rationale. More specifically, in order to improve the quality of their educational work, school communities have to collaborate and at the same time to expand their learning in a way that is collectively responsible for the schools’ changes and transformation. These processes also challenge a. school management to change towards to the “leadership for learning”, b. teachers to form a “community of learning” and c. the school to become a “learning organization”.

#### **e. Governing a Precarious Subject?**

We have noticed above that the Commission by introducing the OMC as a ‘soft’ form of governance has embodied European education policy discourse and practices with performative technologies (guidelines, timetables, benchmarks, monitoring, peer practices). The Commission, a decade ago, has also placed great emphasis on the process of “*measuring progress and the achievement of the common education objectives*” by setting key indicators, benchmarks, monitoring and evaluation procedures (Lawn, 2011), in order to “*underpin key policy messages, analyse progress both at the EU and national levels, identify and compare good performance for peer review and exchange*” (European Commission, 2009: 14).

Scholars have mentioned that throughout the Lisbon Strategy implementation the new European education space is now ruled/ governed by numbers and quality standards (Grek 2008). During the present decade, the “policy by numbers” approach remains one of the dominant features of the EU educational strategy: “*For the period to 2020, policy cooperation should be supported by benchmarks which fully reflect the identified long term strategic challenges...*” (European Commission, 2008:13). In the 2015 Joint Report the Council and the Commission pointed out that the governance of ET 2020 has been improved, in particular by strengthening the

“evidence building” (the Education and Training Monitor) and the operational character of Working Groups. Furthermore, it stressed that *“strong analytical evidence and progress monitoring are essential for the effectiveness of the ET 2020 framework, and will be carried out in cooperation with Eurostat, the Eurydice network, Cedefop and the OECD”* (Council of the EU, 2015). On the basis of the stocktaking report (2012-15) the Council indicates as major governance/working methods: *“Streamlining and rationalising reporting, use of the analytical and up-to-date facts and figures, new peer learning activities, the dissemination of good practices and lessons learned, the Education and Training Monitor providing up-to-date thematic and country-specific evidence”*(Ibid: 30-31).

In this vein, the Teaching Professions (teachers, school leaders, teacher educators) discourses and practices are also highly visible in the latest policy documents concerning the overall EU strategic plan “E&T 2020”. Clusters, working groups, conferences, working documents, empirical evidence, mainly in the form of research findings and monitoring reports, became the main input for OMC comparisons and assumptions. The “Professional development of teachers and Trainers” was one of the “16 core indicators for monitoring progress towards the Lisbon objectives” identified by the European Council in May 2007 (CEU, 2007a). Alongside, the Commission sponsored a series of “working conferences” and “peer learning activities” (PLAs) (e.g. the Cluster “Teachers and Trainers” or the Thematic Working Group (TWG) “Teacher Professional Development”) which aimed at “finding solutions to common problems” concerning teachers and teacher education. During the following years, some of the main issues studied by the TWG focused at “School Leadership for learning” (EC/TWG, 2010), “Supporting teacher competence development for better learning outcomes” (European Commission, 2013a), “Supporting teacher educators”, (European Commission, 2013b). More recently the Commission published the report “European ideas for better learning: The governance of school education systems” (European Commission, 2018), based on the previous Working Group Schools (2016-18).

In addition to the working groups (Clusters, TWG), the Commission has developed close cooperation on education and training with OECD. Issues such as teachers’ skills and competences, school leadership, school effectiveness have been key areas of a common interest framework. OECD’s international research findings (PISA, PIAAC, TALIS) have been proposed/used by the Commission to evaluate/disseminate policy learning processes and comparisons at the national level.

This EU’s teacher profession “discourses of quality and practices of performativity” reflects a “quality/performativity nexus” of ‘techno-preneurial’ governance (Pasiás & Roussakis, 2013). It is part of a global education agenda which promotes a new teacher’s identity closely connected with a competitive performativity framework (Robertson, 2012). The deployment of accountability and performativity audits as policy devices establish control regulations to the teachers’ profession. More specific, these are implemented by technocratic mechanisms, rituals & routines: planning, timetables, databases, monitoring & observation, inspection, interviews, meetings, reports, peer evaluation and assessment processes ...

Performativity and disciplinary processes colonize and re-place school & teachers' life and render teachers as "managed professionals" (Codd, 2005: 194), who are constantly challenged to conform their skills and competences to prescribed profiles. Teachers, as "shape-shifting portfolio people", are expected to "*build(ing) up a variety of skills, experiences, and achievements in terms of which they can define themselves as successful now and worthy of more success later*", but also to "*stand ready and able*" to rearrange their portfolios creatively, and redefine themselves "*as competent and worthy*", if and when circumstances change (Gee, 2004: 96). Moreover, teachers are called upon to produce measurable results and optimize their performance, to set aside their principles and commitments and be *ethically* accountable to students, parents & community, *professionally* to colleagues, *contractivlly* to employers & state, *marketlly/customerlly* to parents / clients.

A competence-based society is a lifelong l'earning society, a "totally pedagogised society" (Bonal & Rambla, 2003, Singh, 2014). A society which promotes and imposes a new "ethical normalization" of subjects controlled by the neoliberal market-driven paradigm: competitiveness, adaptability and efficiency, as the norms of a post-modern educational darwinism! The value of knowledge (and education in a broader sense) within this paradigm inheres in its ability and utility to "educapitalization of the self", to develop human capital effectively as the creation of the knowledge worker. To the extent that neoliberal economic rationale transforms/shapes all social relations in its own image, it commodifies knowledge, making the education outcomes objectified, measurable and transferable. Consequently, in the context of lifelong learning, credentialism becomes inherent in the education system: the more credentials possessed in the shape of certificates and degrees, the more marketable the individual. The self as constant/permanent learner is placed inevitably to an economic entrepreneurial bios (Ball, 2009; Brancalone & O'Brien, 2011).

This ethical normalization, this new subjectification is closely connected with the "pedagogy of debt", the fabrication of the "homo debtor", the making of an "entrepreneurial self": Students and teachers are involved to a continuous, interminable process of ongoing "l'earning" based on measurable (standardized, certified, qualified) training results. They are indebted to acquire the necessary skills/competences, to 'pay to learn', to be accredited, to be evaluated, to be accountable, to 'sell' their selves, facing a precarious and uncertain future (Read, 2009; Peters, 2016; Beighton, 2016).

It has to be mentioned that the "new l'earning/competence based paradigm" develops in a globalized environment of political instability, social deregulation and economic risk. The effects of the prevailing social and economic dystopia (poverty, marginalization, social exclusion) are visible in contemporary European societies. Economic crisis, debt, austerity, unemployment, deregulation of labor relations, social exclusion are expanding and affecting education (Peters et al., 2015).

This paradigm shift leads to the formation of the "precariat" (educated, specialized, civilized but also potentially unemployed) human resource, i.e. the modern educational 'proletariat' of a market-driven/competence society (Standing, 2011).

In this sense, is the prevalence of the new “policy l’earning” just about the delusional promise of governing a Precarious Subject?

## References

- Alexiadiou, N. (2007). The Europeanisation of education policy: Researching changing governance and ‘new’ modes of regulation. *Research in Comparative and International Education*, 2 (2): 102–116.
- Alexiadou, N. (2014). Policy learning and europeanisation in education: the governance of a field and the transfer of knowledge In: A. Nordin & D. Sundberg (eds.), *Transnational policy flows in European education: the making and governing of knowledge in the education policy field*. Oxford: Symposium Books, pp. 123-140.
- Alexiadou, N., Fink-Hafner, D. & Lange, B. (2010). Education policy convergence through the open method of coordination: theoretical reflections and implementation in ‘old’ and ‘new’ national contexts. *European Educational Research Journal*, 9 (3): 345-358.
- Auld, E. & Morris, P. (2014). Comparative education, the ‘New Paradigm’ and policy borrowing: constructing knowledge for educational reform. *Comparative Education*, 50(2): 129-155.
- Ball, S.J. (2009). Lifelong learning, Subjectivity and the Totally Pedagogised Society. In: Peters, M.A. et al. (eds), *Governmentality Studies in Education*, Sense Publishers, pp. 201-216.
- Ball, S.J. (2003). The teacher’s soul and the terrors of Performativity. *Journal of Education Policy*, 18(2): 215-228.
- Beighton, C. (2016). Payback time? Discourses of lack, debt and the moral regulation of teacher education. *Discourse: Studies in the Cultural Politics of Education*, 37(1): 30-42.
- Bonal, X. & Rambla, X. (2003). Captured by the Totally Pedagogised Society: Teachers and Teaching in the Knowledge Economy. *Globalization, Societies and Education*, 1(2): 169-84.
- Bonal, X. (2003). The Neoliberal Educational Agenda and the Legitimation Crisis: old and new state strategies. *British Journal of Sociology of Education*, 24(2): 159-175.
- Brancaleone, D. & O’Brien, W. (2011). Educational commodification and the (economic) sign value of learning outcomes. *British Journal of Sociology of Education*, 32 (4): 501-519.
- Brockling, U. (2015). *The entrepreneurial self: Fabricating a new type of subject*. London: Sage.
- Brown, W. (2015). *Undoing the Demos: Neoliberalism’s Stealth Revolution*. New York: Zone Books.
- Brunila, K. (2011). The Projectisation, Marketisation and Therapisation of Education. *European Educational Research Journal*, 10 (3): 421-432.
- Burton-Jones, A. (1999). *Knowledge Capitalism: business, work and learning in the new economy*. Oxford: Oxford University Press.
- Codd, J. (2005). Teachers as ‘managed professionals’ in the global education industry: the New Zealand experience. *Educational Review*, 57(2): 193-206.
- Council of the EU (2006). Recommendation (2006/962/EK) on key competences for lifelong learning, OJ L394/10, Brussels, 30.12.2006.
- Council of the EU (2007). A coherent framework of indicators and benchmarks for monitoring progress towards the Lisbon objectives in education and training, OJ 2007/C 1083/07, Luxemburg.
- Council of the EU (2009). Council conclusions of 12 May 2009 on a strategic framework for European cooperation in education and training (‘ET 2020’), OJ C 119/2, 28.5.2009, Luxemburg.
- Council of the EU (2015). New priorities for European cooperation in education and training, OJ C417\_15.12.2015.
- Dardot, P. & Laval, C. (2013). *The New Way of the World: On Neoliberal Society*. London: Verso books.
- European Commission (2008). An updated strategic framework for European cooperation in education and training. COM (2008) 865final, Brussels, 16.12.2008.
- European Commission (2009). *Progress towards the Lisbon objectives in education and training - Indicators and benchmarks 2009*. Commission Staff Working Document. SEC(2009) 1616 final, Brussels, 23.11.2009
- European Commission (2012). Rethinking Education: Investing in skills for better socio-economic outcomes, COM (2012) 669, Strasbourg, 20.11.2012.
- European Commission (2013a). *Supporting teacher competence development for better learning outcomes*, Thematic Working Group ‘Professional Development of Teachers’. Brussels: European Commission, July 2013.
- European Commission (2013b). *Supporting teacher educators*, Thematic Working Group ‘Professional Development of Teachers’. Brussels: European Commission, Oct. 2013.
- European Commission (2018). *Teachers and school leaders in schools as learning organizations*. Brussels.

- European Commission (2018). *European ideas for better learning: the governance of school education systems*. Brussels.
- European Commission (2015). New priorities for European cooperation in education and training, COM (2015) OJ C417\_408, Brussels, 26.8.2015.
- European Council (2000). *Presidency Conclusions* (Lisbon, 23-24/3/2000), Brussels.
- Gee, J.P. (2004). *Situated language and learning: A critique of traditional schooling*. London: Routledge.
- Gillies, D. (2008). Developing governmentality: conduct and education policy. *Journal of Education Policy*, 23(4): 415-427.
- Grabher, G. (2004). Learning in Projects, Remembering in networks? Communitality, Sociality and connectivity in projects ecologies. *European Urban and Regional Studies*, 11(2): 103-123.
- Grek, S. (2008). From Symbols to Numbers: the shifting technologies of education governance in Europe. *European Educational Research Journal*, 7 (2): 208-218.
- Grek, S. (2010). International Organisations and the Shared Construction of Policy 'Problems': problematisation and change in education governance in Europe. *European Educational Research Journal*, 9(3): 396-406.
- Grek, S. (2013). Expert moves: international comparative testing and the rise of expertocracy. *Journal of Education Policy*, 28(5): 695-709.
- Haahr, J.H. (2004). Open co-ordination as advanced liberal government. *Journal of European Public Policy*, 11(2): 209-230.
- Haas, P. (1992). Introduction. Epistemic communities and international policy coordination. *International Organization* 46(1): 1-35.
- Hargreaves, A. & Fullan, M. (2012). *Professional capital: Transforming teaching in every school*. New York: Teachers College Press.
- Harris, A. & Jones, M. (2010). Professional learning communities and system improvement. *Improving Schools*, 13 (2): 172-181.
- Hodgson, N. (2018). The entrepreneurial self. In P. Smeyers (ed.), *International Handbook of Philosophy of Education*. Switzerland: Springer International Publishing, pp.1201-1221.
- Hodson, D. & Maher, I. (2001). The Open Method as a New Mode of Governance: The Case of Soft Economic Policy Co-ordination. *Journal of Common Market Studies*, 39 (4): 719-46.
- Jessop, B., Fairclough, N. & Wodak, R. (eds.) (2008). *Education and the Knowledge-Based Economy in Europe*. Rotterdam: Sense Publishers.
- Klerides, E. & Kotthoff, H-G. (2015). Global Governance in Education: A Plea for an Agenda of Shape-Shifts. *European Education*, 47 (3): 191-198.
- Kools, M., & Stoll, L. (2016). What makes a school a learning organisation? *Education Working Paper No. 137*. Paris: OECD Publishing.
- Kovach, I. & Kucerova, E. (2009). The Social Context of Project Proliferation: the rise of a project class. *Journal of Environmental Policy & Planning*, 11(3): 203-221.
- Lawn, M (2011). Standardizing the European Education Policy Space, *European Educational Research Journal*, 10 (2): 259-272.
- Lawn, M. & Grek, S. (2012). *Europeanizing Education. Governing a new policy space*, Oxford, UK: Symposium Books.
- Lazzarato, A. (2009). Neoliberalism in Action: Inequality, Insecurity and the Reconstitution of the Social. *Theory, Culture & Society*, 26(6): 109-133.
- Lingard, B., Creagh, S. & Vass, G. (2012). Education policy as numbers: data categories and two Australian cases of misrecognition. *Journal of Education Policy*, 27(3): 315-333.
- Mahon, R. & McBride, S. (2009). Standardizing and disseminating knowledge: the role of the OECD in global governance. *European Political Science Review*, 1(1): 83.
- Marsick, V. J., Watkins, K. E., & Boswell, S. A. (2013). Schools as Learning Communities. In: R. Huang et al. (eds.), *Reshaping Learning, New Frontiers of Educational Research*. Berlin - Heidelberg: Springer - Verlag, pp. 71-88.
- Martens, K. & Balzer, C. (2004). *Comparing Governance of International Organizations - The EU, the OECD and Educational Policy*. Paper presented to the European Consortium for Political Research (ECPR): International Organizations and Policy Implementation, Uppsala, Sweden.
- Martens, K., Nagel, A., Windzio, M., & Weymann, A. (2010). *Transformation of education policy*. Basingstoke: Palgrave Macmillan.
- Maylor, H., Brady, T., Cooke-Davies, T. & Hodgson, D. (2006). From Projectification to Programmification, *Science Direct International Journal of Project Management* (24): 663-674.

- Mulder, M. (ed) (2017). *Competence-based Vocational and Professional Education: Bridging the Worlds of Work and Education*, Switzerland: Springer International Publishing.
- Normand, R. (2010). Expertise, Networks and Indicators: the construction of the European strategy in education. *European Educational Research Journal*, 9(3): 407-421.
- Normand, R. (2016). *The Changing Epistemic Governance of European Education*, Switzerland: Springer International Publishing.
- OECD (2005). *Defining and Selecting Key Competencies*. Paris: OECD.
- Ozga, J., Dahler-Larsen, P. & C. Segerheolm, C. (eds.) (2011). *Fabricating quality in education: Data, governance in Europe*. London: Routledge.
- Packendorff J. & Lindgren M. (2014). Projectification and its consequences: Narrow and broad conceptualizations. *SAJEMS Special Issue 17: 7-21*.
- Pasias, G. (2005). OMC as a policy of 'learning', as a practice of 'theasis' (spectation) and as a technology of 'surveillance'. *Comparative and International Education Review*, 5, 13-49. Athens: ELESE/Patakis [in Greek].
- Pasias, G., Roussakis, Y. (2013). Discourses of Quality, Practices of Performativity: Restructuring Teacher Education and Professional Development Policies in the "Europe of Knowledge". In: Karras, K. G. et al. (eds.), *Education and Teacher Education Worldwide. Current Reforms, Problems and Challenges*. University of Crete/Dept. of Primary Teachers Education, Rethymno, Crete, pp. 39-48.
- Peters, M. (2016). Biopolitical Economies of Debt. *Analysis and Metaphysics*, 15(1): 7-19.
- Peters, M. A., Paraskeva, J., & Besley, T. (eds.) (2015). *The Global Financial Crisis and the Restructuring of Education*. New York: Peter Lang.
- Peters, M.A. & Reveley, J. (2012). Retrofitting drucker: knowledge work under cognitive capitalism. *Culture and Organization*, pp. 1-17.
- Peters, M.A., Besley, A.C., Olssen M., Maurer, S. & Weber, S. (2009). *Governmentality Studies in Education*. Rotterdam: Sense Publishers.
- Rapplee, J. (2012). *Educational policy transfer in an era of globalization*. Frankfurt am Main: Peter Lang.
- Read, J. (2009). A Genealogy of Homo-Economicus: Neoliberalism and the Production of Subjectivity. *Foucault Studies*, 6: 25-36.
- Rhodes, R.A.W. (1997). *Understanding Governance*. Buckingham: Open University Press.
- Robertson, S.L. (2012). *Placing' Teachers in Global Governance Agendas*, Centre for Globalisation, Education and Societies, University of Bristol. Available at: <http://susanleerobertson.com/publications>.
- Room, G. (2005). Policy Benchmarking in the European Union. *Policy Studies*, 26(2): 117-132.
- Rosenau, J. & Czempiel, E. (1992). *Governance without Government: Order and Change in World Politics*. Cambridge: Cambridge University Press.
- Shore C. (2008). Audit culture and liberal governance: Universities and the politics of Accountability. *Anthropological Theory*, 8(3): 278-298.
- Simons, M. & Masechelein, J. (2008). The governmentalization of learning and the assemblage of a learning apparatus. *Educational Theory*, 58 (4): 391-415.
- Singh, P. (2014). Totally Pedagogised Society: Contributions to Critical Policy Studies. Educationalization, Pedagogisation and Globalisation. Paper Presented at the 8th International Basil Bernstein Symposium 2014, at Nanzan University's Nagoya Campus, Nagoya, Japan, 8 July-12 July 2014.
- Singh, P. (2015). Performativity and pedagogising knowledge: globalising educational policy formation, dissemination and enactment. *Journal of Education Policy*, 30(3): 363-384.
- Standing, G. (2011). *The precariat: the new dangerous class*. London: Bloomsbury.
- Stoll, L. & Louis, K. (eds.) (2007). *Professional learning communities: Divergence, depth and dilemmas*. Berkshire: Open University Press.
- Strathern, M. (ed.) (2000). *Audit cultures: Anthropological studies in accountability, ethics, and the Academy*. London: Routledge.
- Stratou, Ch. (2018). *From the Open Method of Coordination to projects. Discourse, policies and practices of the European Action Programs*. Dissertation (M.Ed), School of Philosophy, Department of Philosophy, Pedagogy and Psychology. Athens: National & Kapodistrian University of Athens [in Greek].
- Uluorta, H. & Quill, L. (2009). In pursuit of the knowledge worker: educating for world risk society. *International Studies in Sociology of Education*, 19(1): 37-51.

**TOPIC 10: REGIONAL DEVELOPMENT AND GOVERNANCE IN THE EU AND GREECE**



### 10.1. Regional Governance and Modularized Training-Reskilling towards Policy Improvement: The Case of the Research Project “Governance, Sustainability and Regional Innovation” (KA 4289)

*Maria Drakaki<sup>1</sup>, Stylianos Ioannis Tzagkarakis<sup>2</sup>, Apostolos Kamekis<sup>3</sup>, Kostas A. Lavdas<sup>4</sup>, Dimitrios Kotroyannos<sup>5</sup>, Nikos Papadakis<sup>6</sup>*

#### Abstract

According to a series of surveys and studies there is a crucial relation between governance, human resources development and administrative capacity, which could play a decisive role in the effectiveness of governance towards sustainable development in Public Administration and Local Government. The present papers deals with the Training- Reskilling Programme for the Executives of the Local Administration in Crete. The abovementioned programme was developed based on the key findings of the needs assessment, which was carried out within the framework of the Research Project entitled “Governance, Sustainability and Regional Innovation” (KA 4289) in Crete. The primary aim of the Training-Reskilling Programme was the capacity building among the Local Government Executives and staff and subsequently, its positive contribution to policy improvement. Therefore, this study analyses briefly the theoretical dimensions and the key components of the multi-parametric relation between governance, sustainability and regional development, focusing on the key role of reskilling in the development of Local Government human resources towards the improvement of regional governance. In the second part, the analysis specifically focuses on the methodological strategy of the Research Project, emphasizing on the needs assessment and its key research findings, based on which the Training-Reskilling Programme for the Local Government Executives and staff that was designed and implemented. Accordingly, the framework, the outline, the modules, the teaching methods and the evaluation process of the Training-Reskilling Programme are presented and analyzed. The study concludes with a broader set of evidence-based proposals related to the processes of reskilling and capacity building of the Local Government structures’ human resources.

**Keywords:** Governance; Reskilling; Capacity Building; Local Administration Executives’ Training

#### 1. Introduction and basic conceptualisation

The term “governance” is used mostly in political discourse with a focus on central and decentralised public administration due to a lack of, and a search for an appropriate political coordination (Böcher, 2008). However,

---

<sup>1</sup> Dr. of the Department of Political Science of the University of Crete, Researcher of the Centre for Political Research and Documentation (KEPET), Department of Political Science, University of Crete, Greece, Email: drakakim@gmail.com

<sup>2</sup> Dr. Teaching Fellow, Postdoctoral Researcher of the Department of Political Science and Researcher of the Centre for Human Rights (KEADIK), Department of Political Science, University of Crete, Greece

<sup>3</sup> Dr. of the School of Medicine, University of Crete, Researcher of the Centre for Human Rights (KEADIK), Department of Political Science, University of Crete, Greece

<sup>4</sup> Professor at the Department of International, European and Area Studies, Panteion University of Athens Deputy Director of the Centre for Political Research and Documentation (KEPET), Department of Political Science, University of Crete, Greece

<sup>5</sup> Professor and Director of the Centre for Human Rights (KEADIK), Department of Political Science, University of Crete, Greece

<sup>6</sup> Professor and Director of the Centre for Political Research and Documentation (KEPET) Department of Political Science, University of Crete, Deputy Director of the University of Crete Research Center for the Humanities, the Social and Education Sciences (UCRC) Greece

there is a lack of a generally accepted definition for governance as a concept. On the contrary, it is characterised by diversity and hence ambiguity (Rhodes, 1996; Stoker, 1997).

It turns out though that there was an emergence of new forms of governance, in which policy-making and decision-making processes are based on an ongoing negotiation between public and private (socio-economic) actors - interest groups (Eberlein & Kerwer, 2002). These mainly focus on enhancing the concept and principles of sustainability and sustainable development on the basis of three pillars, i.e. environment, economy and society. Therefore, these new forms of governance also contribute to strengthening decentralised administration as well as regional innovation and development (Papadakis & Lavdas, 2017; Papadakis et al., 2018).

Additionally, there is a relation between governance, human resources development and administrative capacity as well as a distinction between capacity and competence. These play a decisive role in the effectiveness of governance towards sustainable development in Public Administration and Local Government (Papadakis et al., 2018; Papadakis & Pechlivanides, 2010). Thus, providing training-reskilling to Public Administration and Local Government executives is necessary in the context of a modern Public Administration model (Cardona, 2009) as well as it constitutes a major component in acquiring and/or updating competences related to strengthening human resources' administrative capacity (Adomonis, 2009). Furthermore, it turns out that such training-reskilling programmes increase Public Administration and Local Government executives' effectiveness and thus, lead to the promotion of sustainable development in Public Administration (Drakaki et al., 2017). These programmes should have, in general, two common characteristics: i. group-centred, and ii. be based on the experiences and needs of executives working for the specific public service (ILO, 2007). Furthermore, horizontal skills related to administrative capacity, formulation of strategies and communication (mental skills), as well as social skills (see Papadakis et al., 2012; Holley & Jennings, 1994), are considered crucial for human resources at Local Government (Drakaki et al., 2017).

## **2. Scope, basic determinants and aspects of the Research Project**

The Research Project entitled "Governance, Sustainability and Regional Innovation" (KA 4289), was implemented through the Agreement between the Region of Crete and the University of Crete (Professor Nikos Papadakis was the Team Leader). The research was implemented by the Centre for Political Research and Documentation (KEPET) and the Centre for Human Rights (KEADIK) of the Department of Political Science of the University of Crete, and it was funded by the Region of Crete (project duration: 19/10/2015-18/04/2018) (Papadakis & Lavdas, 2017; KEPET & KEADIK, 2017a: <http://governance.soc.uoc.gr/>). This research project included the design and implementation of an evidence-based Training Programme for Local Government Executives in Crete, on the basis of the needs assessment findings and the triangular methodological strategy of the Research Project (Papadakis & Lavdas, 2017).

Particularly, the Project's aim was to investigate and analyse the multidimensional relation between governance and sustainable development, placing particular emphasis on issues related to regional innovation

in the Region of Crete (Papadakis & Lavdas, 2017). The Project's main objective was the conduction of needs assessment, the development of a feasibility study for a Postgraduate Academic Programme, the design and implementation of a Training Programme for Local Government Executives, as well as the formation of an evidence-based policy proposal set on the basis of the principles of sustainability, good governance and regional innovation, in order to foster economic growth and strengthen social cohesion in the Region of Crete (Papadakis & Lavdas, 2017).

The Research Project aimed both at promoting and strengthening the existing knowledge and at producing new knowledge regarding sustainable development and governance, also in terms of their interaction, through the design of the educational activity at higher education level (design of proposed Postgraduate Studies Programme) and the training activity (design and implementation of Executives Training Programme), based on the findings of the needs assessment and the parallel development of an evidence-based policy proposal set for the Region of Crete, on the basis of the following main pillars:

1. Political Stability and Quality of Regulatory Mechanisms
2. Efficiency of Governance
3. Sustainable Development and Environmental Protection
4. Social Policy and Improved Insurance Systems
5. Determinants of Sustainability
6. Sustainable Development, Agricultural Products and Public Health
7. Tourist Product and Development in Crete" (KEPET & KEADIK, 2015: 2-3).

### **3. The Qualitative Research and the Needs-Assessment: Methodology and Findings**

The methodological strategy of the Research Project "Governance, Sustainability and Regional Innovation" (KA 4289) has used a combination of quantitative and qualitative research (mixed methods) and was based on triangulation (see Patton, 2002; Creswell, 1998; Thurmond, 2001). Thus, it combined different methodological approaches, as well as different methodological tools for data collection and analysis, in order to study the research topic thoroughly and in depth (KEPET & KEADIK, 2015; Denzin, 1978; Robson, 2010; Papadakis et al., 2016).

Focusing on the Project's primary qualitative research (needs assessment), it should be firstly mentioned that it was based on the principles of Grounded Theory, in order to explore in depth and highlight views from Local Government Executives, social partners and civil society representatives, as well as the needs, shortcomings, problems and barriers regarding regional governance and sustainable development in Crete (KEPET & KEADIK, 2015).

Moreover, the following parameters were also highly significant:

- the flexible and inductive nature of Grounded Theory, as long as it is a research procedure which emerges initially from an investigation of characteristics related to the research object, and then a progressive

construction of conceptual categorisations follows, in order to result in composing, explaining and formalising potential correlations and relations based on the research findings (Lacey & Luff, 2001),

- the use of different tools for quantitative and qualitative data collection (structured questionnaire, semi-structured interview, narrative interview) (see KEPET & KEADIK, 2016b; Tzagkarakis et al., 2017), in the context of triangulation and mixed methods, allowed the increase of information pluralism and interpretative depth of the findings, focusing on both state-of-play analysis and needs assessment as regards formulating policy proposals and training human resources towards reskilling in the Region of Crete (KEPET & KEADIK, 2015).

Particularly, regarding the data collection tools used in the qualitative research – needs assessment, i.e. semi-structured interview and narrative interview, due to the flexibility and insights they provide as qualitative tools for collecting and producing data (Robson, 2010), they gave insight on key characteristics of the design, formulation and implementation of policies by the responsible actors at regional and local levels, and the views and perceptions of interested institutions, groups and social partners in the Region of Crete (see also KEPET & KEADIK, 2015).

The primary qualitative research (needs assessment) was conducted in all four Regional Units of the Region of Crete, by using semi-structured interview and narrative interview, with elected and non-elected Local Government Executives and Social Partners' representatives (KEPET & KEADIK, 2016b). A total of 16 semi-structured and 4 narrative interviews were carried out, with proportional distribution in all Regional Units of the Region of Crete, i.e. 4 semi-structured and 1 narrative interview per Regional Unit in order to further investigate the opinions of the local executives and social partners' representatives about the problems and challenges they face in the level of local governance (KEPET & KEADIK, 2016b). The outcomes of the qualitative research provided a number of important insights and conclusions in the context of the needs assessment regarding the Region of Crete, in particular regarding issues related to existing shortcomings and needs, perceptions and perspectives, which can be summarized as follows:

Generally, there is a positive view in terms of the economic competitiveness level of the Region of Crete, compared to the rest of Greece, mainly due to tourism. However, there are concerns regarding the effects of financial difficulties in employment and business (see KEPET & KEADIK, 2016b).

Regarding innovation and research issues, the interviewees pointed out that the level is very high in Crete, due to the close and multidimensional cooperation between the Region of Crete and the Universities and Research Institutions of Crete. However, it should be noted that enhancement of cooperation and coordination among all concerned institutions (KEPET & KEADIK, 2016a) as well as strengthening the association between Universities and the production process (KEPET & KEADIK, 2016b) seem to be imperative according to the majority of the respondents.

Apart from tourism, the Cretan diet and tradition, the geographical position of the island and its natural resources, as well as the high-quality products of its primary sector are the main competitive advantages of the Region of Crete (KEPET & KEADIK, 2016b). Although all these are at a sufficiently high level, their promotion and visibility needs to be further enhanced because, according to the interviewees, there is a lack of coordination between the institutional bodies of the island, towards designing a common strategy to further strengthen local economy (KEPET & KEADIK, 2016b). Promoting visibility of the Cretan diet and products, extending the tourist season, improving infrastructure, and enhancing the effectiveness of tourism linkage to the primary sector appear to be important parameters for bolstering tourism and, thus, the economy of the Region of Crete (KEPET & KEADIK, 2016b). Regarding the investment environment in the Region of Crete, the findings of the qualitative research (needs assessment) showed that it is largely affected, as is the case in the rest of Greece, by bureaucracy, ineffective policies, existing administrative inefficiencies, e.g. bureaucracy and corruption of public officials (KEPET & KEADIK, 2016b). The change in the tax system, the enhancement of more flexible financing opportunities for businesses, the use of programmes promoting entrepreneurship through the creation of artisanal parks, the use of the Greek Development Law, and cooperation between production agencies, are, according to the interviewees, the most important means to improve competitiveness in Crete (KEPET & KEADIK, 2016b).

Regarding infrastructure in Crete, interviewees appear quite dissatisfied, and think that redevelopment of the Northern Highway of Crete (BOAK) (KEPET & KEADIK, 2016b) and modernisation of the ports and airports in Crete, using funding from public-private partnerships or the European Investment Bank, are an immediate priority (KEPET & KEADIK, 2016b).

With regard to the international image of Crete, the findings of the needs assessment showed that the promotion of the brand name 'Crete' internationally is quite sufficient, but more focus should be given on the promotion of the Cretan tradition, gastronomy and culture, as well as targeted tourism (e.g. medical, religious tourism etc.) (KEPET & KEADIK, 2016b). Thus, interviewees underline the need to provide training programmes for tourism professionals, in order to acquire or upgrade their existing competences towards taking sustainable investment initiatives (KEPET & KEADIK, 2016b; Tzagkarakis et al., 2017). Regarding the primary sector of the economy in Crete, the qualitative findings showed that the crisis, but mainly insufficient policy initiatives in the field of agricultural subsidies during the years preceding the crisis, as well as the lack of land planning, constitute the main parameters of the lack of a sustainable primary sector in Crete. However, some of the interviewees believe that the economic crisis has contributed to the return of the young population to the primary sector through their engagement in activities related to this sector of the economy but they should be sufficiently bolstered (KEPET & KEADIK, 2016b; Tzagkarakis et al., 2017). Moreover, the creation of cooperatives and partnerships between producers and all local and regional actors, as well as the provision of training and guidance to professionals of the primary sector would, according to the interviewees, contribute to sustainable development in the primary sector on the one hand, and to the planning of a common strategy for the promotion of local Cretan products, while, at the same time, improving and modernising their quality

and the methods for production and placing on the market (KEPET & KEADIK, 2016b; Tzagkarakis et al., 2017).

Regarding the quality of life in Crete, the qualitative findings showed that the interviewees believe that the level is better compared to the rest of Greece, in spite of the fall in incomes and in the citizens' purchasing power. The contribution of regional authorities, local community and local actors appears to be extremely important in addressing societal problems which have been aggravated by the crisis, although financial resources are still limited. However, intervention and provision of resources by the central government is insufficient, or negligible (KEPET & KEADIK, 2016b; Tzagkarakis et al., 2017). Concerning the environmental sustainability in the Region of Crete, it appears that there is insufficient accurate information to citizens regarding renewable energy resources and environmental issues, which in certain cases, poses problems to investments in these sectors and also to sustainability in general. Furthermore, there seems to be a lack of spatial and environmental planning for renewable energy sources, which had led to their unregulated and uncontrolled installation in the past (KEPET & KEADIK, 2016b; Tzagkarakis, 2017). However, all interviewees, although being dissatisfied with environmental policies adopted, due to the inadequate promotion of actions and strategies at national, regional and local levels, the lack of a stable economic environment, and the unreliability of the central government as to decision-making (KEPET & KEADIK, 2016b; Tzagkarakis et al., 2017), consider that environmental sustainability is the primary objective in the development of regional policy (KEPET & KEADIK, 2016b).

Regarding Regional Governance, the qualitative findings of the needs assessment showed that interviewees appear satisfied with the 'Kallikratis' Programme of Local Administration in Greece, although they point out the need for specific changes so as to give more authority to Local Government institutions, and in order for the central government to allocate the legal mandatory resources to Local Government (KEPET & KEADIK, 2016b). Although 'Kallikratis' Programme seems to have created a decentralised administration as regards responsibilities, which allows for timely intervention to address and resolve problems (Tzagkarakis et al., 2017), it appears that, in several cases, there is an involvement and overlapping of responsibilities between the central government and local government agencies, but also between the responsibilities of the agencies of the Regional Units and the responsibilities of the headquarters of the Region of Crete (KEPET & KEADIK, 2016b).

In terms of the staff of the Local Government in Crete, they seem to have the appropriate skills and specialisation that are necessary for their work, mainly in the Region and to a lesser extent in Municipalities (KEPET & KEADIK, 2016b). Particularly, in the first-degree of Local Government (Municipalities), there seems to be a lack of well-trained and specialised staff (KEPET & KEADIK, 2016b). It is worth mentioning that young employees recruited under fixed-term contracts, both in the first and in the second degree of Local Government, even though they possess specialised knowledge and skills, do not have the time to gain the necessary work experience because they leave due to the expiry of their contract; in addition, the financial

resources to hire qualified staff are insufficient (KEPET & KEADIK, 2016b: 55). Generally, there is decent cooperation between the Region of Crete and municipalities, in contrast to the involvement of social partners and civil society representatives in regional and municipal networks, who, according to interviewees, participate in insufficient levels (KEPET & KEADIK, 2016b).

Regarding human resources in the Local Government in Crete, the qualitative findings of the needs assessment show that there is a positive view and satisfaction, particularly for elected executives. A great number of non-elected executives, mainly in the second degree of Local Government (Regional level) and to a lesser extent in the first degree of Local Government (Municipalities), appear to possess appropriate skills and qualifications to satisfactorily perform the functions and duties assigned to them (Drakaki et al., 2017; KEPET & KEADIK, 2016b). In municipalities, there is apparently substantial lack of skills and specialisation regarding administrative staff, which often undermines the effectiveness in solving practical issues, the implementation of major projects and the proper functioning of different services in the Region of Crete (Drakaki et al., 2017; KEPET & KEADIK, 2016b). In this context, continuous training and reskilling in combination with incentives to Local Government executives in order to participate in training-reskilling programmes, as well as the acquisition and/or further development of skills related to human resources management, new technologies, communication and cooperation with European institutions and European programme management, are considered by interviewees essential towards the improvement of administrative and organisational capacity of Local Government executives, the effectiveness of Regional Governance and, consequently, the sustainable development in Crete (Drakaki et al., 2017; KEPET & KEADIK, 2016b). Preparing comprehensive studies for infrastructure projects, financing from EU institutions and/or private entities through partnerships or concessions, reforming the 'Kallikratis' Local Administration Programme, strengthening companies through the Development Law and promoting social dialogue, are of primary importance, according to interviewees, in terms of policy interventions. Moreover, utilizing empirical scientific methods for needs assessment in the tourism sector and other sectors such as the agricultural, training-reskilling of the Local Government executives on new technologies and all skills related to their work, training and awareness-raising among citizens on renewable energy sources and environmental issues, as well as training and awareness-raising among all tourism personnel on tourism, incorporate the set of policy proposals made by interviewees, who consider that these are absolutely necessary for promoting sustainable development in Crete (KEPET & KEADIK, 2016b; Papadakis & Lavdas, 2017; Tzagkarakis et al., 2017).

#### **4. The Analytical Framework of the research- based Training Programme**

Based on the outcomes of the conducted triangular needs assessment, a Training Programme for Local Government Executives in Crete was designed and implemented. It was actually based on the learning objectives, the expected learning outcomes and the relevant learning material per module. In fact, it was a targeted and modularised training process for executives with reskilling features, following the international standards on training (KEPET & KEADIK, 2017c).

The implementation of the Training Programme for Executives of the first and second degree of Local Government (Municipalities and Regional authorities), such as social partner representatives, production actors and civil society, from all four Regional Units of Crete, sets the theoretical axes and the thematic bases for sustainability and good governance in terms of implementing regional policies, providing, thus, the necessary capacity building (KEPET & KEADIK, 2017b; 2017c). The key objective of the Training Programme was to offer to trainees advanced knowledge on the trends of sustainability, which is considered one of the most important pillars for the future and stability of the EU, while fostering the development of appropriate skills-competences on issues related to governance, finance, agriculture, tourism, administration and society at a regional level (KEPET & KEADIK, 2017b; 2017c).

The modules of the Training Programme were based on the seven abovementioned pillars of the Project, and the Training Programme was implemented by Professors and Experts on a series of crucial subjects (thematic fields), both with physical presence and by asynchronous distance training, the latter being carried out through the distance learning platform specifically designed for this purpose by the Institute of Computer Science (ICS) of the Foundation for Research and Technology - Hellas (FORTH) (see <https://governance.soc.uoc.gr>) (KEPET & KEADIK, 2017d).

The Training Programme for Local Government Executives was based on mixed methods, namely the implementation of the Blended Learning model, which is achieved by using:

- i. Enriched lecture in the context of training with physical presence
- ii. Theory, enriched with images and links
- iii. Case study
- iv. E-Learning Platform for distance training (KEPET & KEADIK, 2017c: 3).

Specifically, the Training Programme comprised two different module categories [55 hours for employees (non-elected executives) & 75 (55+ 20) for elected executives in Local Government], which included general and specialised modules (allowing participants to choose modules) and were both implemented through training with physical presence combined with distance training (KEPET & KEADIK, 2017c).

Additionally, the Training Programme included evaluation of the trainees, which was conducted as part of their participation in the Training Programme, but was also based on how many of the Training Programme's criteria they met, i.e. active participation both with physical presence and in the distance training. The evaluation procedure was carried out in three successive phases: i. initial evaluation, ii. interim evaluation, and iii. final evaluation (KEPET & KEADIK, 2017c: 11).

Particularly, during the initial evaluation, the expected aims of the trainees regarding the content of the Training Programme modules were processed (see also KEPET & KEADIK, 2017c). In the interim evaluation, the trainers conducted the necessary monitoring of the training progress through the distance training using the



E-Learning Platform. The trainees were assigned small tasks-exercises per module (general and specialised modules), linking theory to practice and/or work experience, which the trainees had to complete by the end of the Training Programme and before the final evaluation (KEPET & KEADIK, 2017c). Regarding the final evaluation, this included the overall evaluation of the trainees by the trainers, through person-to-person contact, as well as the evaluation of the Training Programme by the trainees (KEPET & KEADIK, 2017e; 2017f). Lastly, throughout the Training Programme, self-evaluation was a necessary precondition both for each trainer and for trainees (KEPET & KEADIK, 2017c).

## 5. Concluding Remarks

Regional governance and sustainable development in the Local Government in the region of Crete is a component of many different, but at the same time, interlinked parameters. Building the qualifications and the specializations of Local Government's human resources (elected and non-elected executives) constitutes a necessary precondition and a determining factor for the successful achievement of sustainable development in the Region of Crete. "Given the role of two-fold training and reskilling in a person's professional and social development, as well as the importance given by the agenda of the European Lifelong Learning Strategy, the participation of Local Government Executives in training-reskilling and Lifelong Learning programmes is deemed necessary, in order to acquire or further develop administrative and organisational competences, as well as targeted skills-competences related to their everyday work" (Drakaki et al., 2017: 116).

In the abovementioned context and according to research analysis (Drakaki et al., 2017: 116), it is necessary to focus on the creation of databases regarding existing structures, training-reskilling programmes and human resources engaged in these structures as well as on the conduction of needs-in-skills assessment of local government executives in all fields and at all levels. Furthermore, it turns out that it is crucial to strengthen dialogue and coordination between the various actors (both public and private) that are involved in the provision of training-reskilling for the Local Government executives (mobilisation of resources, providing incentives, etc.) while create and further promote networking in training-reskilling for Local Government executives, for the diffusion of knowledge and the exchange of "good practices" on reskilling and capacity building.

## References<sup>7</sup>

- Adomonis, V. (2009). *Building a Civil Service for EU Membership: Democracy and Market Economy*. Paper presented in the SIGMA Conference on Public Administration Reform and European Integration, Budva, 26-27 March 2009.
- Böcher, M. (2008). Regional Governance and Rural Development in Germany: The Implementation of LEADER+. *European Society for Rural Sociology*, 48 (4): 372-388.
- Cardona, F. (2009). *Modernizing the Civil Service*. OECD SIGMA.
- Creswell, J. W. (1998). *Qualitative Inquiry and Research Design Choosing Among Five Traditions*. Thousand Oaks, CA: Sage Publications.
- Denzin, N. K. (1978). *The Research Act: A Theoretical Introduction to Sociological Methods* (2nd ed.) New York: McGraw-Hill.

---

<sup>7</sup> (G): In Greek

- Drakaki, M., Papadakis, N., Liverakos, P. (2017). Good Governance and Sustainability in Local Government: Developing Horizontal Skills. In N. Papadakis & K. Lavdas (Eds.), *Governance, Sustainability and Innovation at Regional Level* (Conference Proceedings). Heraklion: Printing Center of the University of Crete, pp. 96-121 (G).
- Eberlein, B. & Kerwer, D. (2002). Theorising the New Modes of European Union Governance. *European Integration online Papers (EIoP)*, 6 (5): 1-16.
- Holley, W. & Jennings, K. (1994). *Labour Relation Process*. Canada: Cengage Learning.
- ILO (2007). *The Role of Trade Unions in Workers' Education: The Key to Trade Union Capacity Building*. Geneva: ILO.
- KEPET & KEADIK UoC (2015). *Deliverable 2.1. Report on the Methodological Strategy of the Field Research*. Research Project "Governance, Sustainability and Regional Innovation" (KA 4289), December 2015, Rethymnon (unpublished) (G).
- KEPET & KEADIK UoC (2016a). *Deliverable 3.4. Report on the Design of an Interdisciplinary Postgraduate Programme and the Design of a Training Programme in the subject of "Governance, Sustainability and Regional Innovation", based on the Research Findings of the Needs Assessment in the Region of Crete*. Research Project "Governance, Sustainability and Regional Innovation" (KA 4289), September 2016, Rethymnon. Available at: <http://governance.soc.uoc.gr/wp-content/uploads/2017/01/Ekthesi-Tekmiriosis-PMS-Final.pdf> (retrieved on 22-11-2018) (G).
- KEPET & KEADIK UoC (2016b). *Deliverable 3.1. Report on Recording and Analysis of the Primary Qualitative Data (Analysis of Semi-Structured and Narrative Interviews)*. Research Project "Governance, Sustainability and Regional Innovation" (KA 4289), September 2016, Rethymnon. Available at: <http://governance.soc.uoc.gr/wp-content/uploads/2017/01/D.3.1.pdf> (retrieved on 22-11-2018) (G).
- KEPET & KEADIK UoC (2017a). *Deliverable 8.1. Website Construction and Updating (Project Website): http://governance.soc.uoc.gr/*. Research Project "Governance, Sustainability and Regional Innovation" (KA 4289), April 2017, Rethymnon, <http://governance.soc.uoc.gr/> (G).
- KEPET & KEADIK UoC (2017b). *Governance and Sustainability in the Region of Crete: The Research Project and its Findings at a Glance*. Deliverable 8.2. Production of the Informative Material (Leaflet) of the Research Project "Governance, Sustainability and Regional Innovation" (KA 4289), October 2017. Heraklion: Printing Center of the University of Crete. Available at: <http://governance.soc.uoc.gr/wp-content/uploads/2017/09/D8.2-Leaflet.pdf> (retrieved on 22-11-2018) (G).
- KEPET & KEADIK UoC (2017c). *Deliverable 7.1a. Capacity Building Framework for Local Government Executives and Employees*. Research Project "Governance, Sustainability and Regional Innovation" (KA 4289), May 2017, Rethymnon (unpublished) (G).
- KEPET & KEADIK UoC (2017d). *Deliverable 5.1. E-Learning Platform: https://governance.soc.uoc.gr*. Research Project "Governance, Sustainability and Regional Innovation" (KA 4289), May 2017, Rethymnon, <https://governance.soc.uoc.gr> (G).
- KEPET & KEADIK UoC (2017e). *Deliverable 7.4a. Evaluation Tool for the Training Programme by Trainees*. Research Project "Governance, Sustainability and Regional Innovation" (KA 4289), June 2017, Rethymnon (unpublished) (G).
- KEPET & KEADIK UoC (2017f). *Deliverable 7.4b. Evaluation of Elective and Service Executives Trainees of Local Government*. Research Project "Governance, Sustainability and Regional Innovation" (KA 4289), June 2017, Rethymnon (unpublished) (G).
- Lacey, A. & Luff, D. (2001). *Qualitative Data Analysis, Trent Focus for Research and Development in Primary Health Care: An Introduction to Qualitative Analysis*. London: Trend Focus.
- Papadakis, N., Kyridis, A., Papargiris, A. & Theodorikakos, P. (2016). Towards a Balanced Holism between Quantitative and Qualitative Social Research in Large Scale Researches: The Case of the Methodological Strategy of the Research Project: Absents' Barometer: NEETs. In I. Pyrgiotakis & Ch. Theofilidis (Eds.), *Research Methodology in Social Sciences and Education. Contribution to Epistemological Theory and Research Practice*. Athens: Pedio Publications, pp. 431-464 (G).
- Papadakis, N. & Lavdas, K. (2017). Governance and Sustainability in the Region of Crete: Research, Challenges and Policy Proposals. In N. Papadakis & K. Lavdas (Eds.), *Governance, Sustainability and Innovation at Regional Level* (Conference Proceedings). Heraklion: Printing Center of the University of Crete, pp. 9-27 (G).
- Papadakis, N., Lavdas, K., Kotroyannos, D., Tzagkarakis, S. I., Kamekis, A., Drakaki, M. (2018). Regional Governance and Sustainability: Research towards evidence-based policy making, at the Region of Crete. *Advances in Social Sciences Research Journal*, 5(8): 280-293.

- Papadakis, N., Fragkoulis, G., Pandis, P. (2012). Identifying and Analysing Best Practices in European National Cases: Emphasis on Issues related to Needs Assessment with regard to the Education and Training of the Executives of Social Bodies and NGOs, as well as Practices of Fine Tuning between Modularized Training and Learning Outcomes in Knowledge, Competences and Skills. In Koinoniko Polykentro – ADEDY, “*Trainers’ Training Programme*”. Accompanying Educational Material. Athens: Koinoniko Polykentro – ADEDY (G).
- Papadakis, N. & Pechlivanides, E. (2010). *(Un)drawing the veil? Evidence-Based policy making on Civil Servant’s Reskilling and Capacity Building. Supranational trends and a national case*. Paper presented in the 2nd UNDP/ RCPAR on Regional Policy Roundtable ‘Towards a new generation of governance reforms in eastern Europe and Central Asia’. 26-27 October, Astana/Kazakhstan. Available at: <http://www.rcpar.org/mediaupload/events/2010RegionalForum/papadakisRCPAR-ASTANARoundtable.pdf> (retrieved on 26-11-2018).
- Patton, M. Q. (2002). *Qualitative Research and Evaluation Methods*. Thousand Oaks, CA: Sage Publications.
- Rhodes, R. (1996). The New Governance: Governing without Government. *Political Studies*, 44: 652-667.
- Robson, C. (2010). *Real World Research* (2<sup>nd</sup> ed.). Athens: Gutenberg (G).
- Stoker, G. (1998). Governance as Theory: Five Propositions. *International Social Science Journal*, 155, 17-28.
- Thurmond, V. (2001). The Point of Triangulation. *Journal of Nursing Scholarship*, 33(3): 254-256.
- Tzagkarakis, S.I., Kamekis, A. & Chourdakis, M. (2017). The Dimensions of Sustainability and Regional Governance within the Qualitative Research. In N. Papadakis & K. Lavdas (Eds.), *Governance, Sustainability and Innovation at Regional Level* (Conference Proceedings). Heraklion: Printing Center of the University of Crete, pp. 63-83 (G).

**TOPIC 11: MEDIA AND THE DIGITAL ERA**

## 11.1. The TV commercials of the Greek bailout referendum 2015

*Aggeliki Flora Thanopoulou<sup>1</sup>*

### Abstract

In this study examined are various political advertisements, concerning the Greek bailout referendum 2015, which was proclaimed by the Greek Prime Minister Alexis Tsipras, on 28th June 2015 and took place on Sunday 5th of July 2015. The Greek people were asked to vote whether the agreement plan submitted by the European Commission, the European Central Bank and the International Monetary Fund to the Eurogroup of 25th June 2015, should be accepted or not by the Greek government. The opinion of the government about the dilemma of the referendum, was the agreement to be rejected. The options of the plebiscite were NO, YES or the opinion of the party KKE, which urged the voters to say no to the proposal of the three European institutions and also to say no to the proposal of the government.

Primary target of this study is to investigate whether, during the short period of one week before the referendum, the Panhellenic broadcasting private TV channels, ANT1, STAR, ALPHA, SKAI and MEGA promoted one of the three political thesis, NO, YES or the opinion of the party KKE, and if one was promoted more than the others by how much on a quantitative basis. On the theoretical part of this study, the meaning and the purpose of the advertisement is to be examined, as well as the evolution of Greek TV and the conditions under which the referendum took place. The method used in this study was the content analysis for studying 399 political TV commercials during the period 28th of June until 5th of July 2015. Basic research result is that all private TV channels took the same position favoring YES against NO and the opinion of the party KKE. Despite the fact that YES was vastly promoted, NO finally was the prevalent opinion.

**Key words:** referendum, political advertisement, television

### 1. The political scene ahead of the 2015 referendum

On January 25, 2015, elections are called. Alexis Tsipras' left-wing party wins the January election. However, in the absence of self-sufficiency in Parliament, as it had 149 seats, the newly elected Prime Minister was forced to move into a government of co-operation with the Panos Kammenos "Independent Greeks" Party. The Prime Minister was mobilized to launch meetings with European partners to find a solution to the country's fiscal problem. However, parliamentary elections have caused an uproar in international trade. Shortly afterwards, it was announced by the European Central Bank that Greek bonds would not be accepted as pledges and that Greek banks would be financed by the ELA mechanism. The Minister of Finance later announced that Greece would now negotiate directly with the institutions and not with the European troika. The negotiations that followed were too painful. The new leftist government had been trying to live up to its pre-election commitments, in particular on unemployment and the level of living of average Greeks. Negotiations became even tougher, as it was rumored that Greece was straddling between the Eurozone and "Grexit" or that the country would lead to controlled bankruptcy.

---

<sup>1</sup> Communication and Mass Media, National and Kapodistrian University of Athens, Email: af.thanopoulou@gmail.com

## **2. The referendum announcement on June 28, 2015**

Following a recommendation by Prime Minister Alexis Tsipras on the progress of negotiations with the European partners, the Council of Ministers, at its meeting on 26 June 2015, decided to hold a referendum on a critical national issue under Article 44 (2) (a) of the Greek constitution, as well as the immediate submission of the proposal to Parliament, for urgent debate, as set out in Rule 115 of the Greek Parliament' Regulation. The proposal for the referendum was announced to the Greek people by Prime Minister Alexis Tsipras in the early hours of Saturday, June 27th.

The Greek people have been asked to vote on whether to accept the draft agreement submitted by the European Commission, the European Central Bank and the International Monetary Fund to the Eurogroup on 25 June 2015. The draft agreement is made up of two separate documents the first is entitled "Reforms for the Completion of the Current Program and Beyond" and the second is "Preliminary Debt Sustainability Analysis". In addition, as no final agreement was reached, there was an urgent need to protect the financial system and the Greek economy in general from the lack of liquidity caused by the Eurogroup's final decision of 27 June, which resulted in not extending its support program to Greece after the night of June 30, when it was over. Wolfgang Schäuble, Germany's finance minister, had called for capital controls and Mario Draghi, president of the European Central Bank, decided not to increase the amount of liquidity lent to Greek banks through ELA. Bearing in mind the decision of the European Central Bank, on the afternoon of June 28, the System Stability Council met and recommended to the Council of Ministers the imposition of capital controls.

## **3. Positions of Greek political parties for the 2015 referendum**

The parties in the Greek parliament presented their positions on the referendum, following the government's announcement of a referendum. SYRIZA, ANEL and "Chrysi Avgi" (Golden Dawn) voted in favor of the referendum and NO, each relying on its own arguments. The ND argued that the question was essentially a "YES" or "NO" in the euro area and said it wanted Greece to remain in the euro. For its part, PASOK considered the referendum unconstitutional, taking a stand for voting against it. YES was also favored by the party "To Potami" (The River). Stavros Theodorakis, the party's leader, has denounced SYRIZA as having a secret agenda for a return to the drachma. The KKE opposed the referendum, opposing also any remedial measures.

## **4. International reactions**

The butterfly effect is confirmed. Just as the fluttering of a butterfly in the Amazon can cause rain in China, so a referendum in Greece seemed to cause huge upheaval around the world. Leading European officials hearing Alexis Tsipras' announcement of the referendum were not only negative but were also trying to influence public opinion in favor of the YES, while warning of the dangers of a possible exit from the Eurozone. In fact, Europeans have pressured the Greek Prime Minister to change the context of the referendum and ask the Greek people to decide if they want to stay in the Eurozone, just like the proposed referendum by Georgios

Papandreou in 2011. The foreign press referred to a much unexpected move on the part of the Greek Prime Minister, arguing that the referendum call would blackmail Europe.

On June 29, 2015, President of the European Commission, Jean-Claude Juncker, said that “in the referendum Greek citizens are invited to answer whether they will stay in the euro or return to the drachma”, a view shared by the big European governments, such as Germany, Italy and France. Spanish Foreign Minister, Luis de Guido, said the July 5 referendum was “meaningless”, while Spanish Prime Minister, Mariano Rajoy, indirectly supported the YES. Venezuelan President Nicolas Maduro favored the NO, while left-wing European parties such as “Die Linke” in Germany, Podemos in Spain, “Sinn Féin” in Ireland, and “Sinistra e Libertà” (Left and Freedom) in Italy in favor of NO. Le Pen was also in favor of NO for its Eurosceptic reasons. In addition, Obama, the former president of the United States of America, had said that Greece is a country that has faced many difficulties lately and must find its way to growth and stay in the Eurozone. He added that both sides should continue to negotiate in the direction of a joint agreement.

### **5. The political ads and the 2015 referendum**

Political advertising has also been established in Greece as an integral part of all elections campaign. US political television advertising begins in 1952 (Carol, 2009: 49-50). In Europe, however, begins much later. A typical example in Greece is the 1989 elections, where non-public television dominated. However, the scene changes in the 1993, 1996, 2000 elections where Greek political marketing follows in the footsteps of the American (Heretakis, 2003: 43-45). Since 1993, political advertising has not only mimicked American techniques, but it has become clear that voters understand the images more easily, despite the candidates' positions on complex issues. As a result, the attitude and behavior of the public was formed during the elections campaigns by the domination of image. It is a fact that the majority of the political ads violates laws and ethics and offend human intelligence.

Political advertising is multidimensional, both because of its functions and because of the medium through it is promoted. Political advertising aims to inform or persuade. The importance of television advertising policy is multiplied if one takes into account the dynamics of the medium through it is promoted (Lau, et al., 1999). Most households, if not all, have a television set and the power of television to diffuse images and events is great. The purpose of advertising policy, like any advertisement, is to create an impression, thereby attracting public attention.

According to Neil Postman (1985), television has become a “post-media” that guides both public opinion and “learning ways”. The visualization of politics and public communication is the result of the hegemony of television. The images combined with the sound gradually replace the discourse. A talented politician, is no longer the charismatic leader, but the one who meets the requirements of television. Politicians have always been actors, but they are no longer just showmen in Parliament, but mostly in the media. And this is what political ads take advantage of (Bolz, 2008: 89-90).

The discourse of political advertising is bound on the party, which enhances the sense of credibility. Sometimes the written text is accompanied by an oral reading, either by the leader of the political party or by an anonymous announcer. Both political advertising and commercial ads have printed text. One of the reasons for the use of written speech is due to the habit of viewers turning the sound down or off completely during ad breaks. The public of political advertising is divided into the following categories: followers, close, opposing, undecided and non-voting ones (Goblias, 1981: 101-111). Commercial advertising attaches great importance to its already existing customers. The same influence have the political ads on its followers. Of course, no voter is dedicated for sure to a party and that is why each party must address to everyone. The close ones are the most likely voters of all but the followers. When a party aims at the opposing voters, it is necessary that they comprise a great part of the public. The undecided before the elections, and until the very last moment is a large group of audience who do not know what to vote for. In bipartisan terms the undecided are the ones who tilt the scales. Each ad has a double effect, direct and indirect. The immediate award of a political ad is the positive vote. On the other hand the indirect effect of political ad is to form the image of a party which will be the prevailing one in the future.

The effectiveness of a promotional message is first judged by “what will be said” and “how it will be said”. The choice of appropriate words plays a primary role, as each word is selected according its load, its literal and metaphorical meaning, its context and its order in the text (Zotos, 2008: 309-310). Television political ads use, among other things, special effects, musical lining, slogans, symbols used to represent a party, or a candidate (Brader, 2005). Commercial advertising uses symbols to promote their products, as does political advertising, where the use of party symbols is commonplace. Of course, the degree of utilization, intensity and emphasis vary according to the party and the era. All these are the visual and audio stimuli with which the party communicates with its audience.

The goal of both commercial advertising and political advertising is to convey the message they want to the public in as few words as possible, even using often sophisticated words or neologisms, superlative adjectives, and repeated comparisons. Also, many times the speech is elliptical, as articles, intentions, links, verbs are silenced, so that the transmitted message has a certain rhythm. The verbs are usually in the present and the future tense, as well as in the imperative. The second singular person is used, as well as the first and second plural person, which give not only vitality and immediacy, but also intimacy. In addition, the use of speech shapes, such as metaphor, simulation and co-signaling, is also evident in order to attract the public's interest. In addition, the role of music in both commercial and political ads, is very important as it helps the listener to recall the elements of advertising (Zotos, 2000: 159-160). For a person or a group of people, a piece of music can evoke emotions or be associated with situations, memories and images (Cook, 2001: 50). Usually cultural contexts are taken into account for the type of music chosen.

The mass media during the pre-elections period undoubtedly further promoted the view in favor of the YES, devoting more television time to the YES, which was perceived by dozens of Greek citizens. Consequently,



finances were imposed by the National Council of Radio and Television, followed by the temporary removal of journalists from the Association of Editors of Athens Daily Newspapers two years after the referendum. Prior to the referendum, a variety of opinion polls had also preceded YES, albeit with little difference from the NO. The outcome of the referendum, however, disputed those polls.

## 6. The results of the referendum

The results of the Greek referendum on July 5, 2015, were 61.31% in favor of NO versus 38.69% in favor of YES. The people's verdict said NO to the memorandum agreement proposed by the Eurogroup. The Greek referendum has been added to a succession of referendums, where European institutions have been disapproved by popular vote.

## 7. Research model

In order to investigate the key research question, “In the Greek referendum of 2015, between television ads in favor of NO, in favor of YES or the proposal of the KKE, an attempt is made to depict the advertising of the various views and if any, more than one opinion was raised by the Greek national TV channels (ANT1, STAR, ALPHA, SKAI, MEGA)?”, we proposed four hypotheses.

The first hypothesis is that we expect TV political advertising domination in favor of YES. Secondly, there are differences in the representation of the YES, NO and the KKE proposal between the TV channels. The third hypothesis is that the duration of TV spots in favor of YES will be longer than those in favor of NO. Fourth, as far as the content of the ads is concerned, political figures are expected to appear in television spots. This particular hypothesis came from Samara Athanasios' research into television political advertising for the National Elections and European Elections from 1993-2007. According to his study of the ND and PASOK parties the ads were initially focused on the party, and as time went on the ads focused on the candidate. Significant differentiation is found in the ads corresponding to ND (Samaras, 2008: 169-176). The purpose of this hypothesis is to study the degree of personalization of political advertising, and as Tinacci-Mannelli points out in 1996, in multi-party Italy, he observed that in all political advertising the party was chosen to be identified through the leader. Whereas, Kaid and Johnston observed that in US political advertisements of 1952-1996, 34% of political messages use the candidate's personality and characteristics as a means of persuasion (Samaras, 2008: 169).

## 8. Methodology

For the purpose of this paper, content analysis, which has been established as one of the most important approaches and research techniques for Media research, will be implemented (Robson, 2010). Data analysis is used for the analysis of audiovisual files, which is the 24-hour program flow of ANT1, STAR, ALPHA, SKAI and MEGA television stations. In total of 360 hours of television programming (July 1 - July 3, 2015) a total of 399 political ads were shown. In order to gather the necessary data, from 26 February to 29 April 2018, we studied the audiovisual material available at the National Council on Radio and Television. The

aforementioned channels, except ERT, had sent a CD that had a 24-hour pre-referendum program stream recorded.

The advertising spots created after the announcement of the referendum expressed all the camps created, namely in favor of the NO, the YES and the KKE proposal. In total, the 24-hour program stream of Greek television featured ten different spots, two in favor of NO, 7 in favor of YES and one in favor of the KKE proposal. Finally, the statistical analysis of the data was done with SPSS.

### 9. Findings

As for the first hypothesis, **Table 1** presents the 399 television political advertisements recorded by the private channels ANT1, STAR, ALPHA, SKAI and MEGA for the period June 29 to July 5, 2015 as follows. Of the total advertising spots, 126 were in favor of NO (31.6%), 248 were in favor of YES (62.1%) and the remaining 25 were for the KKE proposal (6.3%). As the overall picture shows, over 50% of the total ads broadcast were in favor of YES. The hypothesis is upheld. In fact, the hypothesis is reinforced by the fact that all channels on July 1, 2015 only aired TV spots in favor of YES.

**Table 1: Distribution of advertising spots by political view**

Political thesis	Frequency	Rate
NO	126	31,58%
<b>YES</b>	<b>248</b>	<b>62,16%</b>
The opinion of the party KKE	25	6,27%
Total	399	100%

Then, in order to investigate whether there is a systematic relationship between TV channels and political views (NO, YES and KKE Proposal), we will create crosstabs through SPSS (**Table 2**). Whereas, by means of the chi-square test we will see if statistical significance is obtained, that is, if the difference between the frequency of broadcasting the different spots among the channels is statistically significant.

**Table 2: Crosstabulation**

			CODECHAN (TV CHANNELS)					
			1 ANT1	2 STAR	3 ALPHA	4 SKAI	5 MEGA	Total
A1POLITICAL THESIS	1 NO	Count	29	20	21	30	26	126
		% within CODECHAN	29,9%	29,4%	26,3%	38,0%	34,7%	31,6%
	2 YES	Count	63	44	52	46	43	248
	% within CODECHAN	64,9%	64,7%	65,0%	58,2%	57,3%	62,2%	
	3 The opinion of the party KKE	Count	5	4	7	3	6	25
	% within CODECHAN	5,2%	5,9%	8,8%	3,8%	8,0%	6,3%	
Total	Count	97	68	80	79	75	399	
	% within CODECHAN	100,0%	100,0%	100,0%	100,0%	100,0%	100,0%	

**Table 3: Chi-Square Tests**

	Value	df	Asymp. Sig. (2-sided)
Pearson Chi-Square	5,054 <sup>a</sup>	8	,752
Likelihood Ratio	5,063	8	,751
Linear-by-Linear Association	,491	1	,483
N of Valid Cases	399		

a. 3 cells (20,0%) have expected count less than 5. The minimum expected count is 4,26.

As it is proven by the statistical test  $\chi^2$ , significance should have been less than 0.05 ( $sig \leq 0.05$ ), whereas in the present hypothesis the calculated probability is  $P = 0.752$ , i.e. greater than 0.05 and therefore Ho's hypothesis cannot be rejected. Therefore, the variables considered are independent (**Table 3**). As can be seen from the above, all channels followed the same tactic in presenting the views, exaggerating the position in favor of YES. The second hypothesis is rejected.

Another issue worth investigating is whether the ads in favor of YES were longer than those in favor of NO. As shown in the following table (**Table 4**), the political view in favor of YES has seven variants, of which the three longer-lived versions (31s, 37s and 48s) were the main versions aired by the private channels. The remaining four versions, each lasting 10s, were primarily screened after one of the three main versions was shown. In addition, the two versions of NO political advertising are 19s and 21s each and the spot on the KKE proposal lasts 22s. Comparing the duration of the two NO commercials and the three basic versions of YES, the YES advertising spots are longer than the NO and the KKE proposal. The hypothesis is accepted.

**Table 4: Political thesis/ Duration**

Political thesis	Versions	Duration
NO	1st	19s
	2nd	21s
YES	1st	31s
	2nd	37s
	3rd	48s
	4th	10s
	5th	10s
	6th	10s
	7th	10s
The opinion of the party KKE	1st	22s

For a thorough examination of political advertisements, and more specifically for the 4th hypothesis, the content of these advertisements was studied on the basis of political positioning (in favor of NO, in favor of YES and in favor of the KKE) and the appearance of a talking political head. Two of the seven versions of the YES ads featured politicians speaking, none of the NO advertisements featured political figures speaking, while the KKE political advertisement featured photos of six political figures, both Greek and European ones. Of course, no spots appeared with the leaders of the political parties or a representative of the YES Support Committee, as it is not a party. The hypothesis is upheld.

## **9.1 Strategy analysis of advertising messages**

### **9.1.1 Rhetoric**

A key element of political advertising is rhetoric (Gunsch, et. al., 2000). The advertising under study is dominated by advisory rhetoric, which encourages audiences to identify specific modes of action, and emotional rhetoric, where the use of language is intended to stimulate viewers' emotion. Emotional rhetoric and the element of motivation, for example, are in favor of NO. Motivation even stems from the use of verbs in the first plural, (we do, open, vote) and the use of a rhetorical question in a second singular person (Will you let them?). In the YES ads, we find the use of imperative (Don't believe them), second person singular (do you want), first plural plural (he told us, he will compensate us personally, he won't fool us) and finally the motivation is more intense with characteristics of identification, that is, by referring to "Together we will keep Greece safe". Finally, the KKE spot uses the first plural person (We cancel).

### **9.1.2 Persuasion mechanisms**

Political advertising is a tool used by a political campaign to persuade the electorate. The aim of the referendum advertisements, regardless of political camp, was to emphasize the credibility of those who were presented through passion and ethic. The use of first plural person and identification reinforces the credibility of the NO, YES and KKE proposal.

### **9.1.3 Negative advertising**

It is a fact that in Greek television, negative advertising has been used in election campaigns. Negative advertising focuses on the supposed weakness of the opponent (Merritt, 1984; Zotos, 2008: 234). These messages are considered more effective than positive ones because they are better captured in the audience's memory (Garramone, 1984; Johnson-Cartee & Copeland, 1989; Christ et al., 1994; Pinkleton, 1997). However, such ads can also have opposite effects, that is to say, negative reviews for anyone who uses negativity (Garramone, 1985). A study of the advertisements for the July 5, 2015 referendum revealed that the YES Support Committee used negative advertising to promote YES through two of the seven ads it gave away to the channels. Specifically, the YES Support Committee focused mainly on attacking the opponent's views, and in the specific case against Alexis Tsipras and SYRIZA's parliamentary representatives. The attacks referred to the opponent's correctness and reliability to deliver on what he had promised. The YES Support Committee

incorporated SYRIZA's statements and explicit commitments and contrasted them with reality. So a common element in both Greek and American advertising is that anonymity is used to construct negativity.

#### **9.1.4 Soundtrack**

An important element in the process of image building in political advertising is the choice of musical style (Brader, 2006). The referendum television spots did not use any known piece of music, nor do any reference to the tradition of the Greeks, indicating that the music was a complementary, not an essential element. An important element is also the fact that text and speech dominate over the music.

#### **9.1.5 Symbols and Banners**

Another element that we examine in the 2015 referendum political ads is their degree of political party-centricity. All ads sponsored by the parties themselves contain the corresponding party symbols. At the end of all the referendum TV spots either the SYRIZA party and the KKE, or the YES Support Committee, which some have mentioned that hides who paid for this ad, as the YES Support Committee is not a party and can be considered gray propaganda form if the source of the message is not obvious and known (Homer, & Batra, 1994). In addition to party symbols, a common symbol used in Greek political advertising is the flag. As for the TV advertisements for the 2015 referendum, the first advertisement for NO ends with a visual composition that includes part of the Greek flag and the European without the SYRIZA emblem. In the second ad in favor of NO, the ad ends with the coexistence of the Greek and European flag and the banner of the party in the lower right in small size. The YES support committee did not have a specific emblem, while the KKE's advertising ends in red, which is also the color of leftist ideology and the party emblem in the middle of the plan. In addition, in the third version of the YES advertising spot, images were used of Athens' main streets, Monastiraki and Aristotelous Square in Thessaloniki, images that are widely accepted, the meaning of which is given and accepted by the public, in order to transfer the positive contributions from the images to the YES Support Committee.

#### **9.1.6 Select announcer**

Ads are not just words that attract the public's attention. Usually, as in the political ads under consideration, they have a speaker-announcer included. In the referendum advertisements, advertisers used voices to denounce responsibility, but they were persistent, inciting, and aggressive.

### **Discussion**

Sunday, July 5, 2015 was a crucial date for the country's progress. Greece's very small economy is very important for the European and global economy. The impact of Greece's participation in the European Union's integration process over the last thirty years has led to the reform of the country's economic, political and administrative structures. However, Greece has not been able to synchronize its step with European reality.

The ruling party was forced to apply a painful economic policy for the majority of Greek citizens aimed at managing the crisis. But in order to ensure social cohesion and order in economic policy, the limits of social tolerance must also be taken into account. On June 28, 2015, the Greek Prime Minister, Alexis Tsipras, announces a referendum, triggering a wave of reactions both in Europe and in the opposition.

More precisely, the results of the survey show that in the national TV stations under study, ANT1, STAR, ALPHA, SKAI and MEGA, the political position in favor of YES dominates, with 248 (62%) out of 399 TV political ads. Of course, due to the lack of data from ERT, it was not possible to compare the advertisements shown between private and public television. Subsequently, by means of the statistical test  $\chi^2$ , it was found that all channels followed the same line, that is, the predominance of YES to NO. Another element that emerged from the research is the fact that basic advertising in favor of YES was longer than in favor of NO. Last but not least, in two commercials we expected the appearance of political figures, but only in two spots in favor of YES were excerpts from earlier appearances by Alexis Tsipras and SYRIZA parliamentary representatives, and pictures of Greek and European personalities in the KKE spot.

However, despite the campaign for the YES to persuade the majority of voters, NO did prevail over the YES. The result, as Alexis Tsipras initially argued, was a powerful negotiating weapon, expressing the consent of the Greek people to resist the painful fiscal measures imposed by lenders.

SYRIZA's political campaign for NO revolved around the notions of dependency, slavery, dignity and that a small but proud people can resist the stranglehold of the partners. The victory of NO, of popular will, has led many to rally in the Syntagma square and celebrate with the announcement of results with dance and song. But the events that followed overshadowed the atmosphere of NO victory. The reconciliation with the European partners in July 2015 marked the transformation of SYRIZA into a "European party". Indeed, the signing of the third memorandum resulted in the departure of some SYRIZA executives, but its elections victory in September 2015 brought SYRIZA back into the spotlight.

It is noteworthy that a political campaign in favor of YES, not only in Greece, but also in Europe, did not achieve its objectives. The reasons for this failure may be the need for a radical renewal of the party's political staff, the discontent and indignation of the people over the painful fiscal measures imposed by Europe and that throughout modern Greek history, Greeks were dependent on external forces (Tsoukalas, 2013). It is likely that the SYRIZA political campaign was identified with national consciousness and the general need for release from non-Greek powers. The referendum of 2015 may be part of the general Euroscepticism, given the referendums that have taken place in France, the Netherlands, Scotland, Britain, Italy and Spain in recent years.

Future researchers could focus on the reasons for the failure of the YES political campaign and that over-promotion of a political point of view may ultimately work to its detriment. And it also need to be explored if advertising companies have to understand today's affairs and reach the public in a different way than in the past, since we are in a period of intense "apoliticization", given the increased rates of abstention by Greeks from the latest elections and from general social and political life in general.

## References

- Bolz, N. (2008). *The Media Alphabet*. Smili Editions.
- Brader, T. (2006). *Campaigning for hearts and minds: How emotional appeals in political ads work*. University of Chicago Press.
- Brader, T. (2005). Striking a Responsive Chord: How Political Ads Motivate and Persuade Voters by Appealing to Emotions. *American Journal of Political Science*, 49(2): 388–405.
- Christ, W. C., Thorson, E., & Caywood, C. (1994). D0 attitudes toward political advertising affect information processing of televised political commercials? *Journal of Broadcasting and Electronic Media*, 38: 251 - 270.
- Cook, G. (2001). *The Discourse of Advertising*. Second Edition, London: Routledge.
- Garramone, G. M. (1984). Voter responses to negative political ads. *Journalism Quarterly*, 61: 250-259.
- Garramone, G. M., (1985). Effects of negative political advertising: The roles of sponsor and rebuttal. *Journal of Broadcasting & Electronic Media*, 29(2): 147–159.
- Goblias, C. (1981). *Commercial Advertising Techniques Adapted to Political Advertising: How to Make a Successful Election Campaign*. Athens: Perigramma Publications.
- Gunsch, M. A., Brownlow, S., Haynes, S. E., & Mabe, Z. (2000). Differential Forms Linguistic Content of Various of Political Advertising. *Journal of Broadcasting & Electronic Media*, 44(1): 27–42.
- Heretakis, E. (2003). *Political Advertising: An Implication for Parliamentary Elections 2000*. Thessaloniki: University Studio Press Publications.
- Homer, P. M. & Batra, R. (1994). Attitudinal effects of character-based versus competencebased negative political communications. *Journal of Consumer Psychology*, 3: 163-185.
- Johnson-Cartee, K. S., & Copeland, C. A. (1989). Southern voters' reaction to negative political ads in 1986 election. *Journalism Quarterly*, 66: 888-893.
- Lau, R. R., Sigelman, L., Heldman, C., & Babbitt, P. (1999). The effects of negative political advertisements: A meta-analytic assessment. *American Political Science Review*, 93(4): 851-875.
- Merritt, S. (1984). Negative Political Advertising: Some Empirical Findings. *Journal of Advertising*, 13(3): 27–38.
- Postman, N. (1985). *Amusing Ourselves to Death: Public Discourse in the Age of Show Business*. Penguin Books Inc.
- Pardum, J. C. (2009). *Advertising and Society, Controversies and Consequences*. Blackwell Publishing.
- Pinkleton, B. E., Austin, E. W., & Fortman, K. K. J. (1998). Relationship of media use and political disaffection to political efficacy and voting behavior. *Journal of Broadcasting and Electronic Media*, 42: 34-49.
- Robson, C. (2010). *Real World Research. A Tool for Social Scientists and Professional Researchers*. Athens: Gutenberg Publications.
- Samaras, A. (2008). *Television Political Advertising in Greece 1993-2007*. Athens: Kastaniotis Publications.
- Tsoukalas, K. (2013). *Greece of Lithi and Truth, From Long Adolescence to Violent Adulthood*. 2nd Edition, Athens: Themeli Publications.
- Zotos, Ch. G. (2000). *Advertising, Design and Operation in the Business and Advertising Office*. Thessaloniki: University Studio Press.
- Zotos, Ch. G. (2008). *Advertising, Design, Development, Effectiveness*. Thessaloniki: University Studio Press Editions.

**TOPIC 12: HEALTHCARE POLICIES**



## 12.1. Total Quality Management and leadership: a way to improve healthcare services in Greece

*Dimitrios Kritas<sup>1</sup>, Symeon Sidiropoulos<sup>2</sup>, Dimitrios Kakouris<sup>3</sup>*

### Abstract

After the recent economic and fiscal crisis and the increased needs for the provision of better quality health services in Greece, the implementation of appropriate policies by adopting the relevant theoretical approaches has become more critical than ever. The present study examines whether the utilization of total quality management (TQM), in combination with other issues such as the selection of appropriate leadership and patient satisfaction, is reflected in the respective legislative outcomes. In addition, it is investigated whether the specific practices have helped the improvement of health care in Greece and whether there is relevant space and need in a specific direction.

**Keywords:** Total Quality Management, Leadership, Healthcare, Greece, TQM

## Διοίκηση ολικής ποιότητας και ηγεσία: ένας τρόπος για την βελτίωση παρεχόμενων υπηρεσιών υγείας στην Ελλάδα

*Δημήτριος Κρήτας, Συμεών Σιδηρόπουλος, Δημήτριος Κακούρης*

### Abstract

Μετά την οικονομική και δημοσιονομική κρίση και τις αυξημένες ανάγκες για παροχή ποιοτικότερων υπηρεσιών υγείας στην Ελλάδα, η εφαρμογή των κατάλληλων πολιτικών με υιοθέτηση των σχετικών θεωρητικών προσεγγίσεων έχει γίνει πιο κρίσιμη από ποτέ. Στο παρόν μελετάται κατά πόσο η αξιοποίηση της διοίκησης ολικής ποιότητας (ΔΟΠ), σε συνδυασμό με άλλα ζητήματα όπως η επιλογή της κατάλληλης ηγεσίας και η ικανοποίηση ασθενών αποτυπώνεται στις εκάστοτε νομοθετικές επιλογές. Επιπλέον, διερευνάται κατά πόσο οι συγκεκριμένες πρακτικές έχουν βοηθήσει στην βελτίωση των παρεχόμενων υπηρεσιών υγείας στην Ελλάδα και εάν υπάρχουν περιθώρια και ανάγκη βελτίωσης προς κάποια συγκεκριμένη κατεύθυνση.

**Keywords:** Διοίκηση Ολικής Ποιότητας, Ηγεσία, Υπηρεσίες Υγείας, Ελλάδα, ΔΟΠ

## Εισαγωγή

Τα τελευταία χρόνια, ενώ εξελισσόταν η οικονομική και δημοσιονομική κρίση, με την υιοθέτηση κανόνων αυστηρής δημοσιονομικής πειθαρχίας που αυτή επέφερε, το ελληνικό κράτος κλήθηκε να παράσχει υγειονομική κάλυψη σε μεγάλο αριθμό ανασφάλιστων πολιτών - ασθενών λόγω των αυξημένων ποσοστών ανεργίας. Παράλληλα, έπρεπε να διαχειριστεί μια πρωτόγνωρη μεταναστευτική - προσφυγική και ανθρωπιστική κρίση παρέχοντας, έτσι, πρόσβαση στις απαραίτητες υπηρεσίες υγείας. Υπηρεσίες που αφορούν την επείγουσα και βασική υγειονομική περίθαλψη και την παροχή των απαραίτητων φαρμάκων (Σιδηρόπουλος κ.α., 2016: 7). Ταυτόχρονα, η επάρκεια χρηματοδότησης του συστήματος υγείας εξακολουθεί

<sup>1</sup> PhD candidate at the Department of Political Science of the University of Crete and Field Manager of the Public Policy and Administration Research Laboratory of the University of Crete, Deputy President of HAPSc, Email: kritas@hapsc.org

<sup>2</sup> President of HAPSc, University of Piraeus.

<sup>3</sup> European Law and Governance School, EPLO.

να αποτελεί λόγο ανησυχίας, εξαιτίας της πίεσης στις δημόσιες δαπάνες, της μειωμένης βάσης εσόδων του συστήματος ασφάλισης υγείας και του ήδη υψηλού ποσοστού ιδιωτικών δαπανών, (OECD & European Observatory on Health Systems and Policies, 2017: 16) ενώ η επέκταση της παροχής υπηρεσιών υγείας σε περισσότερους δικαιούχους για ακόμη μια φορά έφερε στο προσκήνιο την αδήριτη ανάγκη μείωσης κόστους με παράλληλη βελτίωση των αποτελεσμάτων ποιότητας παροχής υπηρεσιών υγείας.

Η ανάγκη για αντιμετώπιση των παθογενειών του δημοσίου τομέα, της αναποτελεσματικότητας και των αυξανόμενων απαιτήσεων των πολιτών για ποιοτικότερες υπηρεσίες οδήγησαν στην υιοθέτηση προσεγγίσεων και πρακτικών του σύγχρονου δημόσιου management (Ρωσσίδης, 2014: 62-64). Στον τομέα της υγείας κρίνεται αναγκαία η αξιοποίηση τέτοιων σύγχρονων διοικητικών προσεγγίσεων, με σκοπό την βελτίωση της ποιότητας των παρεχόμενων υπηρεσιών υγειονομικής περίθαλψης με παράλληλη μείωση του κόστους και βελτίωση απόδοσης. Μια τέτοια προσέγγιση είναι αυτή της Διοίκησης Ολικής Ποιότητας (ΔΟΠ). Η ΔΟΠ αποτελεί ένα ολοκληρωμένο σύστημα διοίκησης με προσέγγιση διατομεακή, διεπιστημονική, διακλαδική της ποιότητας, απαιτώντας μακροχρόνια και καθολική δέσμευση από όλα τα εμπλεκόμενα μέρη (Μπισκανάκη, 2018: 29) και καθ' όλη τη διάρκεια των επιμέρους διαδικασιών. Η ΔΟΠ, εστιάζοντας στην ποιότητα, έχει ως κύριο σκοπό τη βελτίωση του οργανισμού που τη χρησιμοποιεί ως προς την αποτελεσματικότητα του, την αποδοτικότητα, την ελαστικότητα και το βαθμό της ανταγωνιστικότητας του (Gower, 2001: 27).

Ο όρος «διοίκηση» αφορά στην δέσμευση της διοίκησης σε όλες τις δραστηριότητες του Οργανισμού, ενώ ο όρος «ολική» αφορά την συνολική συμμετοχή των εμπλεκόμενων μερών. Τέλος ο όρος «ποιότητα» αναφέρεται στην εκπλήρωση προσδοκιών και απαιτήσεων των ασθενών. Ως ποιότητα μπορεί να οριστεί η μεγιστοποίηση της ικανοποίησης του ασθενή, αφού υπολογιστούν όλες οι ωφέλειες και οι απώλειες που πρόκειται να αντιμετωπιστούν σε μια διαδικασία υγειονομικής περίθαλψης (Dayton, 2003: 391 – 396; Μαλάμου, 2016: 7 – 8).

Σύμφωνα, με τον Παγκόσμιο Οργανισμό Υγείας (ΠΟΥ) η εστίαση και η συνεχής προσπάθεια για βελτίωση της ποιότητας στην παροχή υπηρεσιών υγείας αφορά τις περιπτώσεις εκείνες που τα συστήματα υγείας κρατών είναι αρκετά ανεπτυγμένα και διαθέτουν αρκετούς πόρους, καθώς έχει καταστεί σαφές, με βάση εμπειρικά στοιχεία, ότι η ποιότητα παραμένει ζητούμενο, λόγω του ότι τα αναμενόμενα αποτελέσματα δεν επιτυγχάνονται πάντα κατά τρόπο προβλέψιμο και υπάρχουν μεγάλες διαφορές στα πρότυπα παροχής υγειονομικής περίθαλψης τόσο εντός, όσο και μεταξύ των συστημάτων υγειονομικής περίθαλψης. Ταυτόχρονα, αφορά και τις περιπτώσεις εκείνες όπου τα συστήματα υγείας, ιδιαίτερα στα αναπτυσσόμενα κράτη, πρέπει να βελτιστοποιηθούν με τη χρήση πόρων για την επέκταση της κάλυψης μεγαλύτερου μέρους του πληθυσμού, με ανάπτυξη διαδικασιών βελτίωσης που πρέπει να βασίζεται σε υγιείς τοπικές στρατηγικές για την ποιότητα, καθώς τα καλύτερα δυνατά αποτελέσματα επιτυγχάνονται μέσα από νέες επενδύσεις στον τομέα (WHO, 2006: 3).

Η ΔΟΠ ως διοικητική πρακτική αποσκοπεί στην μεγιστοποίηση της αξίας παρεχόμενου προϊόντος ή υπηρεσίας, απαιτεί την πλήρη συμμετοχή και δραστηριοποίηση έμψυχων και άψυχων πόρων μιας μονάδας

υγείας, εκτείνεται από πάνω προς τα κάτω στη διοικητική ιεραρχία, οριζόντια ανάμεσα σε διευθύνσεις και τμήματα (Τζωρτζόπουλος, 2018: 650), ενώ αποσκοπεί στην διαρκή βελτίωση της ποιότητας. Για την επίτευξη των στόχων της η ΔΟΠ περιλαμβάνει κάποιες αρχές και μέσα. Σύμφωνα με τον Milakovich, η Διοίκηση Ολικής Ποιότητας στον δημόσιο τομέα περιλαμβάνει τις εξής αρχές (Milakovich, 2011; Ρωσσίδης, 2014: 214-215):

- Σχεδιασμός που θέτει σε προτεραιότητα την ικανοποίηση του πολίτη.
- Αναδιαμόρφωση της έννοιας του «πελάτη», έτσι ώστε να συμπεριλαμβάνει τόσο τους εξωτερικούς πελάτες που είναι οι υφιστάμενοι και δυνητικοί πελάτες, προμηθευτές κ.α., αλλά και τους εσωτερικούς που είναι οι υπάλληλοι των διαφορετικών τμημάτων και θέσεων εργασίας.
- Διαμόρφωση και ανάπτυξη οράματος του οργανισμού που σχετίζεται με τις ανάγκες και απαιτήσεις καθώς και τα προσδοκώμενα αποτελέσματα από τους καταναλωτές.
- Προώθηση μακροπρόθεσμης δέσμευσης όλων των εμπλεκόμενων μερών που μετέχουν στην παραγωγική λειτουργία με επικρότηση και ανταμοιβή της ομαδικότητας, ενθάρρυνση της διάθεσης για βελτίωση και καινοτομία, αναγνώριση, εκτίμηση και υποστήριξη των προσπαθειών που καταβάλλονται από το εργατικό δυναμικό, με παράλληλη προώθηση της ομαδικότητας μέσω της καθιέρωσης κύκλων ποιότητας.
- Σχεδιασμός και υλοποίηση προγραμμάτων επιμόρφωσης και κατάρτισης.
- Διαμόρφωση κατάλληλων αλλαγών στους δημόσιους οργανισμούς, προκειμένου να καθίσταται εφικτή η υλοποίηση των προκαθορισμένων στόχων και η παροχή των κατάλληλων εργαλείων με στόχο την καλύτερη απόδοση.

Στο μοντέλο του Deming για την ΔΟΠ, αυτή ορίζεται ως μέθοδος ηγεσίας και διαχείρισης στην οποία: α) λαμβάνει χώρα εστιασμένη ανάλυση του συστήματος για σφάλματα και παραλλαγές, αντί να κατηγορούνται οι άνθρωποι, β) αναπτύσσεται μια μακροχρόνια συνεργασία με εξωτερικούς και εσωτερικούς προμηθευτές, γ) χρησιμοποιούνται ακριβή δεδομένα για την ανάλυση διαδικασιών και τη μέτρηση της βελτίωσης του συστήματος, δ) συμμετέχει το σύνολο του προσωπικού που εργάζεται στην ανάλυση και τη βελτίωση του συστήματος, ε) θέτει αποτελεσματικές συνεργατικές συναντήσεις ως βάση για ομαδική εργασία, στ) επιβλέπονται προϊστάμενοι και διευθυντές ώστε να καθοδηγούν τη συνεχιζόμενη διαδικασία βελτίωσης, ζ) συμμετέχει το προσωπικό στον καθορισμό στόχων και εξασφαλίζει ότι τα αποτελέσματα είναι ανατροφοδοτούμενα, η) υπογραμμίζεται η ανάγκη για ανώτερα στελέχη τα οποία σχεδιάζουν στρατηγικά, ενώ τέλος θ) επιτυγχάνεται μακροπρόθεσμη βελτίωση μέσω μικρών κλιμακωτών βημάτων (Abdulsattar, 2014: 891).

**Σχεδιάγραμμα 1: Προτεινόμενη θεωρία της διαχείρισης της ποιότητας των υπηρεσιών**

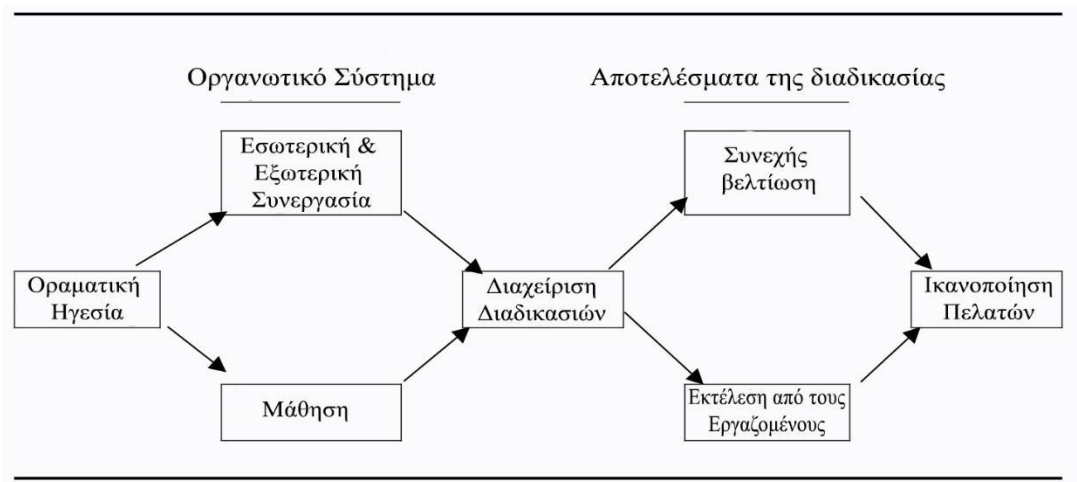

Πηγή: Thomas and Lawrence, 2004: 395.

### Η ηγεσία ως παράγοντας βελτίωσης της ποιότητας υπηρεσιών

Από τους πλέον σημαντικούς παράγοντες για την διαρκή βελτίωση της ποιότητας ενός οργανισμού είναι αυτός της κατάλληλης ανώτερης διοίκησης, δηλαδή της ηγεσίας. Παρόλο που εμπεριέχονται οι διαστάσεις της δύναμης, της εξουσίας και της επιρροής στην έννοια της ηγεσίας, η τελευταία δεν περιορίζεται σε αυτές, καθώς η ηγεσία αποτελεί ουσιαστικά μια διαδικασία επηρεασμού στάσεων και συμπεριφοράς μιας τυπικής ή άτυπης ομάδας από ένα άτομο, ώστε να μπορέσουν να συνεργαστούν για να υλοποιήσουν τους στόχους και την αποστολή της ομάδας με την καλύτερη δυνατή αποτελεσματικότητα (Μπουραντάς, 2005; Παπανικολάου, 2007; Μπισκανάκη, 2018: 30). Η ηγεσία συνδέεται με την ποιότητα φροντίδας στα νοσοκομεία (Eubanks, 1992: 24-36; Faisal et al. 2011: 243), ενώ αποτελεί τον κρίσιμο παράγοντα υλοποίησης ενός οράματος με το οποίο είναι συνυφασμένη. Έτσι, μπορεί να χαρακτηριστεί και ως οραματική ηγεσία.

Μέσα από την οραματική ηγεσία (visionary leadership) μπορεί να διαμορφωθεί ένα όραμα μεγάλης εμβέλειας με σκοπό την ανάπτυξη του οργανισμού, ενώ είναι επιφορτισμένη με την προβολή του οράματος σε ολόκληρο τον οργανισμό, την εκπόνηση και την ανάπτυξη ενός σχεδίου δράσης για την τόνωση ολόκληρης της οργάνωσης προς όφελος του οράματος. Για τον λόγο αυτό, η γνώση και η κατανόηση των βασικών αρχών και ιδεών της διοίκησης ολικής ποιότητας αποτελούν απαραίτητες προϋποθέσεις για τα κορυφαία στελέχη, καθώς τα τελικά οφέλη από την προσαρμογή στην βελτίωση της ποιότητας των υπηρεσιών μπορεί να είναι σημαντικά. Η αληθινή και αποτελεσματική ηγεσία των υπηρεσιών είναι ζωτικής σημασίας για την οικοδόμηση ενός κλίματος αριστείας που ξεπερνά τις λειτουργικές πολυπλοκότητες, τις εξωτερικές πιέσεις της αγοράς ή οποιαδήποτε άλλη πιθανή σύνθετη αντίσταση στην ποιότητα των υπηρεσιών που μπορεί να υπάρχουν (Zeithaml et al. 1990; Sureshchandar et al. 2001: 382). Τέλος, η ηγεσία έχει καθοριστικό ρόλο καθώς επιτρέπει και ενθαρρύνει τα εμπλεκόμενα μέρη να συνεισφέρουν στην οργάνωση, τονίζοντας την ανάγκη για βελτίωση της διαδικασίας και όχι την ατομική ευθύνη, κάτι που αποδεικνύει ότι η δέσμευση των ηγετικών στελεχών

αποτελεί προϋπόθεση για την αποτελεσματική και επιτυχημένη υλοποίηση του TQM (Raja et al., 2007: 363 – 378; Faisal et al., 2011: 243).

### **Η ικανοποίηση πελατών: οι ασθενείς ως πελάτες**

Εδώ και πολλές δεκαετίες η ικανοποίηση των ασθενών από την ιατρική τους φροντίδα θεωρείται σημαντική για την κατανόηση της λειτουργίας ενός συστήματος υγειονομικής περίθαλψης (Dornan, 1988: 637), ενώ σχετίζεται με τις απαιτήσεις τους, τις προσδοκίες-επιθυμίες τους, τη μέτρηση ικανοποίησής τους, τις επαγγελματικές ανάγκες τους, την ευαισθητοποίηση του προσωπικού σχετικά με αυτές και τη σχέση ασθενών – προσωπικού.

Αναφορικά με την ικανοποίηση πελατών ο Kotler υποστήριξε πως αυτή μπορεί να γίνει αντιληπτή ως το πώς αισθάνεται ένα άτομο για την κατάστασή του, που προκύπτει από τη σύγκριση των αντιλήψεων που έχει για ένα προϊόν/υπηρεσία (ή της έκβασης) σε σχέση με τις προσδοκίες που έχει (όπως αναφέρεται στο: Sit et al., 2009: 958). Ο Petersen (1988: 25-35) υποστήριξε ότι η ικανοποίηση αποτελεί μια γενική αντίληψη του ασθενή για την φροντίδα που του παρέχεται, χωρίς να λαμβάνει υπόψιν τα αποτελέσματά της ή την καταλληλότητά της, ενώ ο Smith (1992: 171-177) προσθέτοντας και την έννοια των αναγκών, υποστήριξε ότι η ικανοποίηση των ασθενών είναι συνδυασμός των αντιλαμβανόμενων αναγκών, των προσδοκιών και της εμπειρίας από τη φροντίδα υγείας. Όπως διαπιστώνουμε, παρά το ότι η έννοια της ικανοποίησης πελατών/ασθενών μπορεί να γίνει αντιληπτή ως προς το τι αυτή περιλαμβάνει, είναι δύσκολο να διατυπωθεί ένας ενιαίος και κοινά αποδεκτός ορισμός για την έννοια της ικανοποίησης στους πελάτες/ασθενείς (Bond & Thomas, 1992). Αυτή μπορεί να γίνει εύκολα αντιληπτή ως η αποτίμηση της διαφοράς σε αυτό που προσδοκούν και σε αυτό που τελικά απολαμβάνουν οι πελάτες/ασθενείς. Οι κύριοι παράγοντες που επηρεάζουν τον βαθμό ικανοποίησης των ασθενών αφορούν α) τις προσδοκίες τους, β) τα κοινωνικά και οικονομικά χαρακτηριστικά τους, και γ) τα ψυχοκοινωνικά χαρακτηριστικά τους (Moore et al. 1999: 6; Παπαγιαννοπούλου κ.α. 2008: 82; Καλογεροπούλου, 2011: 668).

### **Η Διοίκηση Ολικής Ποιότητας στην ελληνική νομοθεσία για την υγεία**

Τα ελληνικά νοσοκομεία είναι ανεξάρτητοι αυτοδιοικούμενοι θεσμοί (ΝΠΔΔ), που ως μέρη του ευρύτερου δημόσιου τομέα είναι ενσωματωμένοι στο κράτος. Παράλληλα, η τοποθεσία τους έχει επιλεγεί πολλές φορές με περιστασιακό τρόπο, ενώ τα περισσότερα είναι εγκατεστημένα σε παλιά κτίρια και οι αναδιαρθρώσεις που έλαβαν χώρα δεν ήταν πάντα οι κατάλληλες. Ως προς το προσωπικό τους, ο αριθμός των εργαζομένων δεν μπορεί να θεωρηθεί επαρκής για την ικανοποίηση των σύγχρονων μορφών νοσηλείας και υγειονομικής περίθαλψης (Theodorakioglou & Tsiotras, 2000: 1153-1165).

Στην Ελλάδα από την δεκαετία του '90 έλαβαν χώρα κάποια βήματα για την προώθηση των ζητημάτων που αφορούν στην ποιότητα της υγείας και την ανάπτυξη των σχετικών ποιοτικών χαρακτηριστικών για τα ελληνικά νοσοκομεία, οι οποίοι πολλές φορές όμως παρέμειναν ανεφάρμοστοι. Ειδικά κατά την δεκαετία 2001-2011 έγιναν ακόμη πιο σημαντικά βήματα στην υιοθέτηση αρχών και διαδικασιών της διοίκησης ολικής

ποιότητας. Σήμερα μπορούμε να πούμε ότι υπάρχει ποιοτική πιστοποίηση των σταδίων εφοδιασμού του ελληνικού νοσοκομείου (Κουκουφίλιππου κ.α., 2017: 331).

Στους πρώτους νόμους γίνονται έμμεσες αναφορές και κατοχυρώνονται κάποιες προϋποθέσεις για τον τομέα της ποιότητας. Με τον Ν. 2071/1992 «*Εκσυγχρονισμός και Οργάνωση Συστήματος Υγείας*»<sup>4</sup> κατοχυρώνονται βασικά δικαιώματα του ασθενή, έτσι τίθεται η βάση για την παροχή ποιοτικών υπηρεσιών υγείας. Στον εν λόγω νόμο αναγνωρίζεται στον ασθενή το δικαίωμα προσέγγισης στις υπηρεσίες του νοσοκομείου με τις κατάλληλες συνθήκες για την φύση της ασθένειάς του, γίνεται αναφορά στην ανάγκη για οφειλόμενο σεβασμό στην ανθρώπινη αξιοπρέπεια του ασθενούς, με κατάλληλες υπηρεσίες και εξυπηρέτηση, η προστασία της ιδιωτικής του ζωής και το απόρρητο του χαρακτήρα των πληροφοριών που τον αφορούν καθώς και ο σεβασμός των θρησκευτικών και ιδεολογικών του πεποιθήσεων. Τέλος, αναγνωρίζεται και το δικαίωμα κατάθεσης διαμαρτυρίας και ενστάσεων, καθώς και να λάβει γνώση για τα αποτελέσματά τους. Στον Ν. 2519/1997 «*Ανάπτυξη και εκσυγχρονισμός του Εθνικού Συστήματος Υγείας, οργάνωση των υγειονομικών υπηρεσιών, ρυθμίσεις για το φάρμακο και άλλες διατάξεις*»<sup>5</sup> προβλέφθηκε η λειτουργία γραφείου πολιτών στο εκάστοτε νοσοκομείο, το οποίο θα είναι επιφορτισμένο με την παροχή πληροφοριών στους χρήστες, ενώ θα λαμβάνει τυχόν καταγγελίες ή παράπονά τους. Παράλληλα, προβλέπεται επιτροπή Ελέγχου Προστασίας Δικαιωμάτων Ασθενών και άλλες δομές, όπως και το Ινστιτούτο Έρευνας και Ελέγχου Ποιότητας Υπηρεσιών Υγείας το οποίο θα αναλάμβανε αρκετές αρμοδιότητες όπως η αξιολόγηση υπηρεσιών υγείας, τον έλεγχο διασφάλισης ποιότητας κ.α.

Οι νομοθετικές επιλογές που ακολούθησαν ήταν κάπως πιο στοχευμένες, με τον Ν.2889/2001 «*Βελτίωση και εκσυγχρονισμός του Εθνικού Συστήματος Υγείας και άλλες διατάξεις*»<sup>6</sup> στον οποίο προβλέπεται η δυνατότητα σύστασης σε νοσοκομεία δυναμικότητας άνω των 400 κλινών να συστήσουν αυτοτελές Τμήμα Ελέγχου Ποιότητας, Έρευνας και Συνεχιζόμενης Εκπαίδευσης που υπάγονται στον Διοικητή του νοσοκομείου. Με το εν λόγω νομοθέτημα προβλέφθηκαν και άλλα Τμήματα Βελτίωσης και Ελέγχου Ποιότητας σε περιφερειακό επίπεδο και γενικώς δόθηκε έμφαση στην καθιέρωση ποιοτικού ελέγχου κατά την παροχή υπηρεσιών από τα νοσοκομεία και την αποτελεσματική διαχείριση έμψυχων και άψυχων πόρων. Το ίδιο έτος δύο Προεδρικά Διατάγματα έρχονται για να εμπλουτίσουν το εθνικό θεσμικό πλαίσιο στον τομέα της υγείας. Με το ΠΔ 84/2001 «*Όροι, προϋποθέσεις, διαδικασία και προδιαγραφές για την ίδρυση και λειτουργία Ιδιωτικών Φορέων Παροχής Υπηρεσιών Πρωτοβάθμιας Φροντίδας Υγείας (Π.Φ.Υ.)*»<sup>7</sup> ορίζονται ειδικές επιτροπές από την Εκτελεστική Επιτροπή του Κεντρικού Συμβούλιου Υγείας για τον έλεγχο δημοσίων και ιδιωτικών φορέων παροχής υπηρεσιών πρωτοβάθμιας φροντίδας υγείας. Το ΠΔ 357/2001 «*Οργανισμός Κεντρικής Υπηρεσίας των Περιφερειακών Συστημάτων Υγείας (Πε.Σ.Υ)*»<sup>8</sup> εξειδικεύει την αποστολή των Περιφερειακών Συστημάτων

<sup>4</sup> Νόμος υπ' αριθμ. 2071/1992 - ΦΕΚ 123/Α/15-7-1992

<sup>5</sup> Νόμος υπ' αριθμ. 2519/1997 - ΦΕΚ Α-165/21-8-1997

<sup>6</sup> Νόμος υπ' αριθμ. 2889/2001 - ΦΕΚ 37/Α/2-3-2001

<sup>7</sup> Προεδρικό Διάταγμα υπ' αριθμ. 84/2001 - ΦΕΚ 70/Α/10-4-2001

<sup>8</sup> Προεδρικό Διάταγμα υπ' αριθμ. 357/2001 - ΦΕΚ 240/τ. Α/17-10-2001

Υγείας που ιδρύθηκαν με τον Ν.2889/2001. Ορίζει ότι τα Πε.Σ.Υ. είναι επιφορτισμένα με τη δημιουργία ολοκληρωμένων συστημάτων παροχής υπηρεσιών υγείας στο επίπεδο της Περιφέρειάς τους, αποδίδοντάς τους τον συντονισμό δράσεων και πολιτικών παροχής υπηρεσιών υγείας στο επίπεδο της Περιφέρειάς τους, την ενημέρωση του κοινωνικού συνόλου για πρόληψη ασθενειών και προστασία της υγείας, αλλά και την διαρκή αξιολόγηση και έλεγχο της αποδοτικότητας των υπηρεσιών υγείας με συλλογή των αναγκαίων στοιχείων.

Δύο χρόνια μετά, με τον Ν. 3172/2003 «*Οργάνωση και εκσυγχρονισμός των Υπηρεσιών Δημόσιας Υγείας και άλλες διατάξεις*»<sup>9</sup> θεσμοθετείται το Εθνικό Συμβούλιο Δημόσιας Υγείας (Ε.ΣΥ.Δ.Υ.). Το Εθνικό Συμβούλιο Δημόσιας Υγείας έχει γνωμοδοτικό χαρακτήρα για αρκετά ζητήματα, ενώ μεταξύ άλλων εκφράζει γνώμη και για το σχέδιο αξιολόγησης της ποιότητας, της αποτελεσματικότητας και της αποδοτικότητας των υπηρεσιών δημόσιας υγείας.

Το 2004 έρχονται άλλες δυο μεταρρυθμιστικές προσπάθειες, με τον Ν. 3230/2004 «*Καθιέρωση συστήματος διοίκησης με στόχους, μέτρηση της αποδοτικότητας και άλλες διατάξεις*»<sup>10</sup> γίνεται σαφές ότι οι υπηρεσίες της πρέπει να λειτουργούν πλέον σύμφωνα με τις αρχές της προσέγγισης Διοίκησης Ολικής Ποιότητας, ενώ με τον Ν. 3235/2004 «*Πρωτοβάθμια Φροντίδα Υγείας*»<sup>11</sup> ξεκαθαρίζεται ότι ορίζεται το τι περιλαμβάνει η πρωτοβάθμια φροντίδα υγείας ενώ δίδεται στον Υπουργό η δυνατότητα να συστήνει Φορέα Πιστοποίησης Κέντρων Υγείας, ο οποίος δύναται να διενεργεί τακτικούς και έκτακτους ελέγχους.

Με τον Ν. 3329/2005 «*Εθνικό Σύστημα Υγείας και Κοινωνικής Αλληλεγγύης και λοιπές διατάξεις*»<sup>12</sup> γίνεται μια προσπάθεια για την υιοθέτηση των ουσιαστικών πυλών της Διοίκησης Ολικής Ποιότητας μέσα από την πιστοποίηση και ευθυγράμμιση με διεθνή πρότυπα αλλά και διαπίστευση των υπηρεσιών υγείας. Η διαδικασία αυτή ανατίθεται στο Τμήμα Βελτίωσης και Ελέγχου της Ποιότητας των νοσοκομείων το οποίο επιφορτίζεται με την υποστήριξη των Φορέων Παροχής Υπηρεσιών Υγείας και Κοινωνικής Αλληλεγγύης<sup>13</sup> της οικείας Περιφέρειας για να ενταχθούν σε διαδικασίες πιστοποίησης. Τέλος, ακολουθώντας τις επιταγές της Διοίκησης Ολικής Ποιότητας αναφορικά με το σημαντικό ρόλο της ηγεσίας στο νόμο αυτό προβλέπεται και η θέση Διοικητή Νοσοκομείου.<sup>14</sup> Έναν χρόνο μετά, με το ΠΔ 21/2006 «*Σύσταση Διεύθυνσης Ποιότητας και Αποδοτικότητας και Τμήματος Προσβασιμότητας Ατόμων με Αναπηρίες στο Υπουργείο Υγείας και Κοινωνικής Αλληλεγγύης*»<sup>15</sup> συστήνεται η διεύθυνση ποιότητας και αποδοτικότητας στο Υπουργείο Υγείας η οποία

<sup>9</sup> Νόμος υπ' αριθμ. 3172/2003 - ΦΕΚ Α-197/6-8-2003

<sup>10</sup> Νόμος υπ' αριθμ. 3230/2004 - ΦΕΚ 44/Α/11-2-2004

<sup>11</sup> Νόμος υπ' αριθμ. 3235/2004 - ΦΕΚ 53/Α/18-2-2004

<sup>12</sup> Νόμος υπ. αριθμ. 3329/2005 - ΦΕΚ 81/Α/4-4-2005

<sup>13</sup> Σύμφωνα με το αρ. 2. του Ν. 3329/2005 ως Φορείς Παροχής Υπηρεσιών Υγείας και Κοινωνικής Αλληλεγγύης ορίζονται: Νοσοκομεία, Κέντρα Υγείας και Μονάδες Κοινωνικής Φροντίδας, Κέντρα Ψυχικής Υγείας και Απεξάρτησης, λοιπά νομικά πρόσωπα δημοσίου δικαίου και νομικά πρόσωπα ιδιωτικού δικαίου του δημόσιου τομέα, που ασκούν δραστηριότητες στους τομείς υγείας και κοινωνικής αλληλεγγύης και εποπτεύονται από τον Υπουργό Υγείας και Κοινωνικής Αλληλεγγύης.

<sup>14</sup> Στον νόμο υπ' αριθμ. 3329/2005 άρθρο 7 θεσπίζεται τόσο η θέση του Διοικητή Νοσοκομείου, του Αναπληρωτή Διοικητή, όσο και των μελών Διοικητικού Συμβουλίου με επί μέρους κατηγοριοποιήσεις.

<sup>15</sup> Προεδρικό Διάταγμα υπ' αριθμ. 21/2006 – ΦΕΚ Α' 17/7.2.2006

καθίσταται αρμόδια για την μέτρηση αποτελεσματικότητας και αποδοτικότητας καθώς και για τη διατύπωση προτάσεων για την βελτίωση της ποιότητας στο Υπουργείο και τις υπηρεσίες που υπάγονται σε αυτό.

Με την χώρα πλέον σε οικονομική και δημοσιονομική κρίση το 2011 λαμβάνει χώρα μια νέα μεταρρυθμιστική προσπάθεια με τον Ν. 3918/2011 «Διαρθρωτικές αλλαγές στο σύστημα υγείας και άλλες διατάξεις».<sup>16</sup> Με τον εν λόγω νόμο πραγματοποιείται σειρά παρεμβάσεων και αλλαγών. Μια τέτοια σημαντική αλλαγή αποτελεί η συγκρότηση της Επιτροπής Προδιαγραφών, η οποία επιφορτίζεται με τον καθορισμό ενιαίων προδιαγραφών και προτύπων για κάθε ιατροτεχνολογικό προϊόν, με την δημιουργία, τήρηση και επικαιροποίηση Μητρώων Εγκεκριμένων Προϊόντων, Υπηρεσιών, Προμηθευτών και Παροχών Υπηρεσιών, με την δημιουργία βάσης δεδομένων Παρατηρητηρίου Τιμών και με την σύνταξη πρότυπων διακηρύξεων και συμβάσεων προμηθειών προϊόντων και υπηρεσιών με οδηγίες για τις αναθέτουσες αρχές. Παράλληλα, εκτός των άλλων συστήνεται ο Εθνικός Οργανισμός Παροχής Υπηρεσιών Υγείας (Ε.Ο.Π.Υ.Υ.)<sup>17</sup> για τον οποίον υπάρχει πρόβλεψη και διεύθυνση διασφάλισης ποιότητας. Στο νόμο αυτό μπορούμε να πούμε ότι λαμβάνει χώρα μια σημαντική προσπάθεια συγκέντρωσης διάσπαρτων αρμοδιοτήτων, συστηματοποίησης και τυποποίησης διαδικασιών και τήρησης αρχείων με σκοπό την ποιοτικότερη και οικονομικότερη λειτουργία των υπηρεσιών υγείας.

Αν και στην τρέχουσα Εθνική Στρατηγική και δράσεις του τομέα Υγείας στο ΕΣΠΑ 2014-2020, υπάρχουν αναφορές σε μαξιμαλιστικούς στόχους με δράσεις για την βελτίωση της ποιότητας στις παρεχόμενες υπηρεσίες υγείας, μερικές εκ των οποίων φαίνεται να κινούνται προς την σωστή κατεύθυνση, ωστόσο αυτές φαίνεται πως δεν επαρκούν για την πραγματική υιοθέτηση των κατάλληλων πρακτικών της προσέγγισης της διοίκησης ολικής ποιότητας. Αυτές οι δράσεις και στόχοι χρειάζονται περαιτέρω εξειδίκευση μέσα από κατάλληλες πρωτοβουλίες, ενώ πολλές φορές φαίνεται οι όποιες διακηρύξεις να μένουν σε θεωρητικό επίπεδο. Έτσι, Σύμφωνα με την εθνική στρατηγική 2014-2020, αναλαμβάνονται στόχοι και δράσεις οι οποίες εστιάζουν κυρίως:

- στην ανάπτυξη Τοπικών Μονάδων Υγείας (ΤοΜΥ) στην επικράτεια με μονάδες οικογενειακής φροντίδας υγείας που θα βελτιώσει την ποιότητα παροχής υπηρεσιών υγείας,
- στην θέσπιση Ενιαίου Ηλεκτρονικού Ιατρικού Φακέλου,
- στην βελτίωση της ποιότητας, την ενίσχυση της ασφάλειας και τον εξορθολογισμό της νοσοκομειακής περίθαλψης με εισαγωγή της τεχνολογίας γραμμικού κώδικα (barcode) για τον εκσυγχρονισμό της υλικοτεχνικής μέριμνας των νοσοκομείων,
- στην συγκριτική αξιολόγηση των Κύριων Δεικτών Απόδοσης των νοσοκομείων, κάτι που αποσκοπεί στην βελτίωση της εμπειρίας και στην καταγραφή των ζητημάτων των ασθενών,
- στην μέτρηση ικανοποίησης των ασθενών, η οποία επιδιώκεται να επιτευχθεί μέσα από την σύσταση περιφερειακών κοινών επιτροπών χρηστών - παρόχων υπηρεσιών για την παρακολούθηση της ποιότητας φροντίδας,

<sup>16</sup> Νόμος υπ' αριθμ. 3918/2011 - ΦΕΚ 31/Α/2-3-2011

<sup>17</sup> Βλ. αναλυτικά Ν. 3918/2011 κεφ. Β' άρθρα υπ' αριθμ. 17 έως 30.



- στην σύσταση κοινών επιτροπών αναφορικά με τις λίστες αναμονής στο σύνολο των μονάδων υγείας (Πρωτοβάθμια Φροντίδα Υγείας – Νοσοκομείο) σε τοπικό επίπεδο,
- στην καθιέρωση γραφείων διαχείρισης παραπόνων με ανοιχτή πρόσβαση στα αποτελέσματα και στη διεξαγωγή ετησίων ερευνών ικανοποίησης ασθενών σε όλες τις δημόσιες μονάδες Πρωτοβάθμιας Φροντίδας Υγείας και τα Νοσοκομεία.

Παράλληλα, στο τρέχον Εθνικό Στρατηγικό Σχέδιο για τη Δημόσια Υγεία 2019 – 2022 υπάρχουν επίσης σχετικές αναφορές για την ποιότητα στις υπηρεσίες υγείας, η οποία εστιάζει κυρίως στην ίση παροχή ποιοτικών υπηρεσιών υγείας για όλους. Αυτό επιδιώκεται μέσα από τη χρήση υποχρεωτικών δεικτών για την αξιολόγηση των νοσοκομείων και των διοικήσεών τους, ως κριτήριο ποιότητας των παρεχόμενων υπηρεσιών υγείας, δημοσιοποίηση των δεικτών, καθώς και την εξειδικευμένη κατάρτιση των επαγγελματιών υγείας και ειδικά όσων κατέχουν ηγετικές θέσεις. Έτσι, προβλέπεται ανάπτυξη σχετικών προγραμμάτων κατάρτισης, καθώς και η δημιουργία Μητρώου Δημόσιας υγείας, ώστε να εξασφαλιστεί, μέσω του αρμόδιου προσωπικού, η παροχή υψηλής ποιότητας υπηρεσιών δημόσιας υγείας με ειδικευμένους επαγγελματίες.

### **Συμπεράσματα**

Παρά το γεγονός ότι στην ελληνική νομοθεσία υιοθετούνται αρκετές πτυχές της προσέγγισης της διοίκησης ολικής ποιότητας τα τελευταία 30 χρόνια και σαφώς έχουν γίνει σημαντικά βήματα, μένει να γίνουν αρκετά ακόμη. Η πολυνομία, η υιοθέτηση αποσπασματικών ρυθμίσεων αναφορικά με την υιοθέτηση καλών πρακτικών από την προσέγγιση της ΔΟΠ στην υγεία, η μη εφαρμογή σε αρκετές περιπτώσεις της θεσπισμένης νομοθεσίας και η έλλειψη συνέχειας των εκάστοτε νομοθετικών επιλογών με σκοπό την βελτίωσή τους, δυσχεραίνουν τον επιτυχή σχεδιασμό και υλοποίηση μιας μεταρρυθμιστικής πολιτικής που θα υιοθετεί συνολικά την φιλοσοφία και τις αρχές της ΔΟΠ και θα τις εφαρμόζει επιτυχώς. Παράλληλα, η έλλειψη σχεδιασμού και υλοποίησης ενός σταθερού μακροπρόθεσμου σχεδιασμού μέσα από βραχυπρόθεσμα και μεσοπρόθεσμα μετρήσιμα αποτελέσματα, με τουναντίον εναλλαγή σχεδιασμών και στόχευσης αναλόγως της εναλλαγής πολιτικής ηγεσίας αποτελεί ένα ακόμη ζήτημα που δεν βοηθά στην βελτίωση των παρεχόμενων υπηρεσιών υγείας.

Παράλληλα, παρά το γεγονός ότι μέσα από τη θεσπισμένη νομοθεσία και τις διαδικασίες που πλέον ακολουθούνται έχει διαμορφωθεί σε σημαντικό βαθμό η ποιοτική πιστοποίηση των σταδίων εφοδιασμού των ελληνικών νοσοκομείων, υπάρχουν ακόμη σημαντικές ελλείψεις και αποτελεί πραγματική πρόκληση η βελτίωση της ποιότητας εντός τους (Κουκουφιλίππου κ.α., 2017: 331). Ο κρίσιμος παράγοντας στελέχωσης των υπηρεσιών υγείας με την κατάλληλη επιλογή ηγεσίας που θα είναι προσηλωμένη στην βελτίωση των παρεχόμενων υπηρεσιών υγείας, θα διαθέτει το γνωσιακό υπόβαθρο, αλλά και τα κατάλληλα εργαλεία υλοποίησης καθώς και τις δυνατότητες ευελιξίας, αποτελεί ένα ακόμη ζήτημα που φαίνεται να παραμένει στάσιμο με κατά περιόδους πισωγυρίσματα ως προς την επιλογή διοικητών νοσοκομείων. Η κατάλληλη εκπαίδευση τόσο της ηγεσίας, όσο και του προσωπικού αναφορικά με την υιοθέτηση καλών πρακτικών από την εν λόγω προσέγγιση αποτελεί ένα ακόμη σημαντικό στοιχείο που πρέπει να προωθηθεί.

Η περιοδική μέτρηση της ικανοποίησης ασθενών, παρέχοντας προσβάσιμα στους πολίτες δεδομένα και με την χρήση - αξιοποίηση των νέων τεχνολογιών είναι κάτι που πρέπει να μελετηθεί και να διερευνηθεί με σκοπό την βελτίωση των υπηρεσιών υγείας. Σε κάθε περίπτωση, η υιοθέτηση πρακτικών της Διοίκησης Ολικής Ποιότητας, η πιστοποίηση των σχετικών υπηρεσιών, η στοχοπροσήλωση της ηγεσίας, η παροχή δυνατοτήτων ευελιξίας σε τοπικό επίπεδο μπορούν επίσης να βοηθήσουν προς την κατεύθυνση βελτίωσης υπηρεσιών υγείας.

## Βιβλιογραφικές Αναφορές

### Ξενόγλωσση

- Abdulsattar, M. Al-A. (2014). *Developing a Total Quality Management Framework for Healthcare Organizations*, Proceedings of the 2014 International Conference on Industrial Engineering and Operations Management, Bali, Indonesia, January 7 – 9: 889 – 898.
- Bond, S. and Thomas, L.H. (1992). Measuring patients' satisfaction with nursing care. *Journal of Advanced Nursing*, 17(1): 52-63.
- Dayton, N. (2003). The demise of total quality management (TQM). *The TQM Magazine*, 15(6): 391 – 396.
- Dornan, M. C. and Hall, J.A. (1988). Meta-analysis of satisfaction with medical care: Description of research domain and analysis of overall satisfaction levels. *Social Science & Medicine*, 27(6): 637-644.
- Duggirala, M., Rajendran, C. and Anantharaman, R. (2008). Patient-perceived dimensions of total quality service in healthcare. *Benchmarking: An International Journal*, 15(5): 560-583.
- Eubanks, P, Grayson, M. (1992). The CEO experience. TQM/CQI. *Hospitals*, 66(11):24-8, 30-2, 34-6.
- Faisal, T., Rahman, Z. and Azam M. (2011). Best Practices of Total Quality Management Implementation in Health Care Settings. *Health Mark Q.*, 28(3): 232-252.
- Milakovich, M. (2011). *Digital Governance: New Technologies for Improving Public Service and Participation*. London: Routledge Chapman and Hall.
- Moore, St. and Bopp, K.D. (1999). How consumers evaluate health care quality: Part I, *Health Mark Q*, 16(1): 1-6.
- OECD & European Observatory on Health Systems and Policies (2017). *Ελλάδα: Προφίλ Υγείας 2017*. Paris: OECD Publishing. Available at: <[https://www.oecd-ilibrary.org/social-issues-migration-health/da-f-e-a-2017\\_9789264285224-el](https://www.oecd-ilibrary.org/social-issues-migration-health/da-f-e-a-2017_9789264285224-el)> [Accessed: 28/8/2019].
- Petersen, M.B. (1988). Measuring patient satisfaction: collecting useful data, *Journal of Nursing Quality Assurance*, 2(3): 25-35.
- Smith, C. (1992). Validation of Patient satisfaction system in the United Kingdom, *Quality Assurance in Health Care*, 4(3): 171-177.
- Raja, M. P. N., Deshmukh, S. G., & Wadhwa, S. (2007). Quality award dimension: A strategic instrument for measuring health service quality. *International Journal of Health Care Quality Assurance*, 20(5): 363-378.
- Sit, W.-Y., Ooi, K.-B., Lin, B., Chong, Al. (2009). TQM and customer satisfaction in Malaysia's service sector, *Industrial Management & Data Systems*, 109(7): 957-975.
- Sureshchandar, G., Rajendran, C. and Anantharaman, R. (2001). A holistic model for total quality service. *International Journal of Service Industry Management*, 12(4): 378-412.
- Thomas, D. and Lawrence, F. (2004). Evaluating the Deming Management Model of Total Quality in Services. *Decision Sciences*, 35(3): 393-422.
- WHO (2006). *Quality of Care, A process for making strategic choices in health systems*. World Health Organization, available at: <[http://www.who.int/management/quality/assurance/QualityCare\\_B.Def.pdf?ua=1](http://www.who.int/management/quality/assurance/QualityCare_B.Def.pdf?ua=1)> [Accessed: 7/6/2018].
- Zeithaml, V.A., Parasuraman, A., Berry, L.L. (1990). *Delivering quality service: Balancing customer perceptions and expectations*. New York: Free Press.

### Στα ελληνικά

- Καλογεροπούλου, Μ. (2011). Μέτρηση ικανοποίησης ασθενών, Μέθοδος βελτίωσης ποιότητας και αποδοτικότητας νοσοκομείων. *Αρχαία Ελληνική Ιατρική*, 28(5): 667-673.

- Κουκουφιλίππου, Ι., Μπόμπος, Γ., Μπόγρη, Δ., Βασιλακοπούλου, Β., Κοΐνης, Α. (2017). Το σύστημα Διοίκησης Ολικής Ποιότητας ως προοπτική για το ελληνικό νοσοκομείο. *Αρχαία Ελληνικής Ιατρικής*, 34(3): 327-333.
- Μαλάμου, Θ. (2016). Η μεθοδολογία υλοποίησης της Διοίκησης Ολικής Ποιότητας στις υπηρεσίες υγείας, ως βέλτιστη πρακτική λειτουργία. *Ελληνικό Περιοδικό της Νοσηλευτικής Επιστήμης*, 9(3): 6-15.
- Μπισκανάκη, Ε. και Χαραλάμπους Γ. (2018). Ο ρόλος της ηγεσίας στη διαμόρφωση πολιτικής ποιότητας ενός Οργανισμού Υγείας. *Το Βήμα του Ασκληπιού*, 17(1):26-39.
- Μπουραντάς, Δ. (2005). *Ηγεσία*. Αθήνα: Κριτική.
- Παπαγιαννοπούλου, Β, Πιεράκος Γ., Σαρρής Γ., Υφαντόπουλος Γ. (2008). Μέτρηση Ικανποίησης από τις παρεχόμενες υπηρεσίες υγείας σε παιδιατρικό νοσοκομείο της Αττικής. *Αρχαία Ελληνικής Ιατρικής*, 25(1): 73-82.
- Παπακωστίδης, Α. – Τσουκαλάς, Ν. (2012). Η ποιότητα στις υπηρεσίες υγείας και η αξιολόγησή της. *Αρχαία Ελληνικής Ιατρικής*, 29(4): 480-488.
- Παπανικολάου, Β.(2007). *Η ποιότητα στις υπηρεσίες υγείας*. Αθήνα:Παπαζήσης.
- Ρωσσίδης, Ι. (2014). *Εφαρμογές του Επιχειρησιακού Μάνατζμεντ στην Ελληνική Δημόσια Διοίκηση*. Αθήνα: Σταμούλης.
- Τζωρτζόπουλος, Α. (2018). Εφαρμογή αρχών και εργαλείων της Διοίκησης Ολικής Ποιότητας στο υγειονομικό τομέα – εγγύηση στην ποιοτική αναβάθμιση των νοσοκομείων και του Εθνικού Συστήματος Υγείας. *Αρχαία Ελληνικής Ιατρικής*, 35(5): 650-664.
- Υπουργείο Υγείας – Εθνικό Συμβούλιο Υγείας (2019). *Εθνικό Στρατηγικό Σχέδιο για την Δημόσια Υγεία 2019-2022*. Υπουργείο Υγείας, διαθέσιμο στο: <<https://www.moh.gov.gr/articles/health/domes-kai-drasesis-gia-thn-ygeia/ethnika-sxedia-drashs/6237-ethniko-sxedio-drashs-gia-thn-dhmosia-ygeia>> [Ανακτήθηκε: 1/9/2019].
- Υπουργείο Υγείας – Επιτελική Δομή ΕΣΠΑ (2016). *Εθνική Στρατηγική Υγείας και δράσεις του τομέα υγείας στο ΕΣΠΑ 2014 – 2020*. Υπουργείο Υγείας διαθέσιμο στο <<https://www.moh.gov.gr/articles/health/domes-kai-drasesis-gia-thn-ygeia/ethnika-sxedia-drashs/3948-ethnikh-strathgikh-ygeias-kai-drasesis-toy-tomea-ygeias-sto-esp-2014-2020>> [Ανακτήθηκε: 1/9/2019].

### Νόμοι – Έγγραφα

- Ν.2071/1992 - ΦΕΚ 123/Α/15-7-1992  
Ν.2519/1997 - ΦΕΚ Α-165/21-8-1997  
Ν.2889/2001 - ΦΕΚ 37/Α/2-3-2001  
ΠΔ 84/2001 - ΦΕΚ 70/Α/10-4-2001  
ΠΔ 357/2001 - ΦΕΚ 240/τ. Α'/17-10-2001  
Ν. 3172/2003 - ΦΕΚ Α-197/6-8-2003  
Ν. 3230/2004 - ΦΕΚ 44/Α/11-2-2004  
Ν. 3235/2004 - ΦΕΚ 53/Α/18-2-2004  
Ν. 3329/2005 - ΦΕΚ 81/Α/4-4-2005  
ΠΔ 21/2006 – ΦΕΚ Α' 17/7.2.2006  
Ν. 3918/2011 - ΦΕΚ 31/Α/2-3-2011

## 12.2. Health Communication: Opportunities and Challenges

*Konstantina Briola<sup>1</sup>*

### **Abstract**

The proper functioning of an organization is one of the most important objectives of management. Communication and collaboration between healthcare professionals are key factors for a proper functioning. Effective communication and good cooperation between the two parties - the physician and the patient - can lead to: disease prevention, improved relationships between medical staff and patients, sharing public and personal information on health risk, changes in health behavior, providing education to the population on how to access the health care system, promoting health and quality of life, etc. However, both in society and in the workplace, apart from cooperation there are also conflicts between its members. Good cooperation between healthcare professionals can be disrupted through conflicts. Conflicts arise not only from disagreements but also through disparities in power distribution, ambiguity in responsibilities, stereotypes, etc. Accordingly, the relationship between healthcare professionals with their patients can be disrupted too. The use of the biomedical model, which is prevalent in a number of countries, raises problems in the quality of communication as it offers a one-sided analysis of a problem. Other reasons that lead to such a large communication gap are the differences in education level, the attitude of the doctors towards their patients, the lack of active listening by the doctor, the lack of time, etc. Both medical staff and patients must overcome the communication barriers, in order to ensure the proper functioning of the system itself. Lifelong learning and professional development can lead to the improvement of communication skills. In addition, this type of continuing education could focus on learning specific protocols/clinical guidelines, which the doctor can follow in order to have a better approach of its patients. Undoubtedly, effective communication between physicians and nurses is needed in order to provide even better services to the patients.

**Keywords:** communication, patients, doctors, conflicts, hospital, healthcare

## Η επικοινωνία στον χώρο της υγείας: προβλήματα και προοπτικές

*Μπριόλα Κωνσταντίνα*

### **Εισαγωγή**

Κατά γενική ομολογία, η επικοινωνία είναι το συστατικό στοιχείο που χαρακτηρίζει όλους τους ζωντανούς οργανισμούς (Watson, 2005). Αποτελεί μια διαδικασία, η οποία για να πραγματοποιηθεί προϋποθέτει την ύπαρξη ενός πομπού, ενός δέκτη και την μετάδοση/ανταλλαγή μηνυμάτων. Η διαδικασία της επικοινωνίας αρχίζει από την στιγμή που ο πομπός κωδικοποιεί αυτό που θέλει να μεταβιβάσει- είτε με λεκτικό, είτε με μη λεκτικό τρόπο- σχηματίζοντας στο τέλος ένα μήνυμα. Το είδος των πληροφοριών που ενυπάρχουν μέσα στο μήνυμα κωδικοποιούνται, εν τέλει, από τον δέκτη.

Ωστόσο, τα μηνύματα δεν εμπεριέχουν πάντα ένα κοινό νόημα και για τα δύο συμβαλλόμενα μέρη (Paternotte, 2017). Υπάρχει το ενδεχόμενο είτε ο πομπός να κωδικοποιεί τις εκάστοτε πληροφορίες ανάλογα με τις αντιλήψεις και τις ανάγκες που έχει εκείνη την συγκεκριμένη χρονική στιγμή, είτε να αλλοιώνεται το μήνυμα

---

<sup>1</sup> Political Scientist, MSc cand., Athens. Email: ntinabrio@gmail.com

κατά την μεταφορά του από τρίτα συμβαλλόμενα μέρη (Μαλτσάκη, 2014). Επομένως, η επικοινωνία είναι μια δυναμική διαδικασία, όπου για να υπάρξει μια “διαυγή” επικοινωνία ο αποστολέας θα πρέπει να γνωρίζει τι είναι ικανός ο παραλήπτης να δει και να ακούσει (Μπιτσώρη, 2013).

Η διαδικασία περιπλέκεται όταν κάνουμε λόγο για σύνθετους οργανισμούς, όπως είναι τα νοσοκομεία. Η ανάγκη συντονισμού πολλών και διαφορετικών δραστηριοτήτων, η λήψη αποφάσεων, η διεπιστημονική συνεργασία, καθώς και η ανάγκη παροχής υψηλής ποιότητας υπηρεσιών σπρώχνει τα άτομα στην μεταξύ τους αλληλεπίδραση, με σκοπό να επιτευχθούν κλινικοί και διοικητικοί στόχοι (Μανιαδάκης, 2005).

Η εύρυθμη λειτουργία ενός οργανισμού είναι ένας από τους σημαντικούς στόχους της διοίκησης (Μπιτσώρη, 2013). Βασικοί παράγοντες που συμβάλλουν σημαντικά στην ομαλή λειτουργία ενός οργανισμού είναι η επικοινωνία και η συνεργασία μεταξύ των επαγγελματιών υγείας, εφόσον αποτελούν θεμέλιο λίθο στην μεταξύ τους σχέση. Η αποτελεσματική επικοινωνία μεταξύ των δύο συμβαλλόμενων-του ιατρού και του ασθενή- είναι ζωτικής σημασίας για την σωστή διάγνωση, την κατάλληλη δοσολογία φαρμάκων και την εξασφάλιση της συμμόρφωσης του ασθενούς με μια θεραπεία αγωγή (Betancourt, 2006). Είναι μια διαδραστική διαδικασία ανταλλαγής σκέψεων, συναισθημάτων και άλλων μηνυμάτων που αναπόφευκτα συμβαίνουν κάθε φορά που υπάρχει αλληλεπίδραση μεταξύ δύο ή περισσότερων ατόμων.

### **Η σημασία της επικοινωνίας στον χώρο της υγείας**

Η επικοινωνία στον τομέα της υγείας είναι ένα μέσο για τη διευκόλυνση της αλληλεπίδρασης, τόσο μεταξύ επαγγελματιών του τομέα της υγείας και των ασθενών, όσο και μεταξύ δύο ή περισσότερων επαγγελματιών του τομέα της υγειονομικής περίθαλψης, ανεξάρτητα από το εάν εργάζονται μαζί σε ίδιες ή διαφορετικές οργανώσεις<sup>7</sup>.

Κατά καιρούς έχουν δοθεί πολλές ερμηνείες σχετικά με το τι είναι και τι περιλαμβάνει η επικοινωνία στον τομέα της υγείας. Αναλυτικότερα, το Υπουργείο Υγείας και Υπηρεσιών των ΗΠΑ (2000), αναφέρει πως η επικοινωνία στον τομέα της υγείας είναι η χρήση τεχνικών και τεχνολογιών επικοινωνίας που επηρεάζουν θετικά τις οργανώσεις, τα άτομα και τον πληθυσμό με σκοπό την προώθηση συνθηκών που συμβάλλουν στην προώθηση της υγείας του ανθρώπου και του περιβάλλοντος. Μπορεί να περιλαμβάνει διάφορες δραστηριότητες, όπως αλληλεπιδράσεις γιατρού-ασθενούς, ομάδες αυτοβοήθειας, μαθήματα, αποστολές αλληλογραφίας, εκδηλώσεις και εκστρατείες για τα μέσα μαζικής ενημέρωσης. Άλλοι, όπως ο Cline (2003) και ο Steinberg (2007), αναφέρουν πως η επικοινωνία στον τομέα της υγείας είναι ένα υβριδικό πεδίο που προέρχεται από τις μελέτες επικοινωνίας, το μάρκετινγκ, τη δημοσιογραφία, τις δημόσιες σχέσεις και επικαλύπτεται με την εκπαίδευση για την υγεία και την προαγωγή της υγείας.

Το ζήτημα της επικοινωνίας στην υγεία έχει αναλυθεί εκτενώς από το Αμερικανικό Υπουργείο Υγείας και Ανθρωπίνων Υπηρεσιών (HHS), στο «Healthy People 2010: Final Review», κάνοντας λόγο για την εξαιρετική σημασία που έχει στον υγειονομικό χώρο. Το Healthy People 2010 εμπεριείχε ένα κατάλογο θεμάτων και στόχων. Οι στόχοι αυτοί περιλάμβαναν (National Center for Health Statistics, 2012):

- την ανάπτυξη βασικών γνώσεων στα άτομα για θέματα υγείας
- εκστρατείες επικοινωνίας για την υγεία (αξιολόγηση της διαδικασίας και των αποτελεσμάτων)
- την ανάπτυξη ιστοσελίδων υγείας (σχετικά με την ταυτότητα των υπεύθυνων προσώπων ή οργανισμών, την αποκάλυψη του σκοπού, τις χρήσεις και τους περιορισμούς των τοποθεσιών, την πληροφόρηση για τις πολιτικές απορρήτου, κ.α.)

Σύμφωνα με τους Robinson, Patrick, Eng & Gustafson (1998) οι γιατροί και άλλοι επαγγελματίες υγείας πρέπει να προωθήσουν και να συμμετάσχουν σε αυτό το εγχείρημα. Η συνεργασία μεταξύ των επαγγελματιών υγείας (ιατρικό προσωπικό) και μη επαγγελματιών υγείας (ασθενείς), συμβάλλουν στην εύρυθμη λειτουργία του οργανισμού. Η καλή συνεργασία μεταξύ των ατόμων στον τομέα της υγείας μπορεί να οδηγήσει (Feng et al. 2006): στην πρόληψη των ασθενειών, στη βελτίωση των σχέσεων μεταξύ ιατρικού προσωπικού και ασθενών, στην κίνηση δημόσιων και ατομικών πληροφοριών σχετικά με τον κίνδυνο για την υγεία, στη διαμόρφωση μηνυμάτων δημόσιας υγείας, στην αλλαγή της συμπεριφοράς υγείας, στην παροχή εκπαίδευσης στον πληθυσμό σχετικά με τον τρόπο πρόσβασης στο σύστημα παροχής υγειονομικής περίθαλψης, στην προαγωγή της υγείας και της ποιότητα ζωής, κ.α.

Οργανισμοί με ισχυρές πολιτικές επικοινωνίας μπορούν να εμπλουτίσουν την υγεία των ασθενών τους, ενώ εκείνοι που δεν έχουν εφαρμόσει αποτελεσματικές διαδικασίες μπορεί να έχουν αρνητικό αντίκτυπο στην ευημερία των ασθενών (Rajiv & Lapinski, 2009). Οι Schmidt και Svarstad (2002), υποστήριξαν ότι η ομαδική συνεργασία και η αποτελεσματική επικοινωνία στο χώρο των νοσοκομείων, βελτιώνει τα κλινικά αποτελέσματα, αυξάνει το βαθμό ικανοποίησης των ασθενών και συμβάλλει στη μείωση των δαπανών σε ανθρώπινους και υλικούς πόρους.

Από την άλλη, η κακή επικοινωνία μπορεί να οδηγήσει σε ποικίλα αρνητικά αποτελέσματα, όπως για παράδειγμα: σε ασυνέχεια της περίθαλψης, συμβιβασμό στην ασφάλεια των ασθενών, αναποτελεσματική χρήση πολύτιμων πόρων, δυσαρέσκεια στους ασθενείς, κ.λπ. Η Joint Commission Center for Transforming Healthcare (2012) έχει εκτιμήσει ότι η κακή επικοινωνία είναι υπεύθυνη για το 80% των σοβαρών ιατρικών σφαλμάτων, αυξάνοντας την ανάγκη για εργαλεία και πρακτικές που υποστηρίζουν τη βελτιωμένη επικοινωνία.

### **Εμπόδια στην επικοινωνία μεταξύ των εργαζομένων**

Στον τομέα της υγείας, η συνεργασία μεταξύ των εργαζομένων ίδιου (ή διαφορετικού) επαγγέλματος και με ίδια (ή διαφορετικά) καθήκοντα, αποτελεί βασική προϋπόθεση για τη λειτουργία των υπηρεσιών (Ροβίθης, 2016). Για να υφίσταται καλή συνεργασία θα πρέπει οι υποψήφιοι συνεργάτες να διέπονται από: αυτογνωσία (δηλαδή να γνωρίζουν καλά το ρόλο τους, τις δυνατότητες τους, τις αρμοδιότητες τους, τα δικαιώματα και τις υποχρεώσεις τους), καλοσύνη, πνεύμα συναδελφικότητας, ένδειξη σεβασμού μεταξύ των εργαζομένων, ευγένεια, μετριοφροσύνη, και ανωτερότητα.

Όπως στην κοινωνία έτσι και σε έναν εργασιακό χώρο, πέραν από την συνεργασία υπάρχει και σύγκρουση μεταξύ των μελών που τον απαρτίζουν (Κρανάκη, 2016). Αποτελεί κοινό τόπο πως η συνεργασία προωθεί την συνεργατική δραστηριότητα, παρόλα αυτά, η συνεργασία και η σύγκρουση είναι πανταχού παρούσες και αναπόφευκτα συνυπάρχουν στον κοινωνικό βίο.

Οι συγκρούσεις αποτελούν συχνό φαινόμενο στο χώρο της υγείας. Οι συγκρούσεις δημιουργούνται σε περιπτώσεις όπου υπάρχει ασυμφωνία απόψεων, αξιών και ασυμβατότητα αναγκών και στόχων. Πηγές συγκρούσεων μπορεί να αποτελούν οι ανισότητες στην κατανομή της εξουσίας, η ασάφεια σχετικά με ρόλους και αρμοδιότητες, οι διαφορετικές προσδοκίες και οι προηγούμενες ανεπίλυτες συγκρούσεις (Σταθοπούλου, 2006).

Σύμφωνα με τον Farell (2001), οι συγκρούσεις που συναντώνται στον χώρο της Νοσηλευτικής, όπου βέβαια μερικές από αυτές συναντώνται και στον Ιατρικό χώρο, μπορεί να οφείλονται:

- στην καταπίεση του νοσηλευτικού προσωπικού από διάφορα στερεότυπα σχετικά με την ανωτερότητα του “ιατρικού” επαγγέλματος, το οποίο στην συνέχεια οδηγεί σε συγκρούσεις μεταξύ των επαγγελματιών υγείας
- στην κακομεταχείριση των νεοεισερχόμενων στο επάγγελμα από τους ιεραρχικά ανώτερους, οδηγώντας στην μελλοντική διαιώνιση της συμπεριφοράς αυτής, και
- στον σχηματισμό κλειστών ομάδων με κοινά χαρακτηριστικά, το οποίο φυσικά απειλεί τόσο την κοινωνικοποίηση των ίδιων των ατόμων, όσο και την επικοινωνία καθεαυτή

Στα μεγάλα νοσοκομεία όπου οι νοσηλευτές έρχονται σε επαφή με ιατρούς πολλών ειδικοτήτων, παρατηρούνται έντονες συγκρούσεις. Συγκεκριμένα, στον ιατρικό χώρο, η επικοινωνία μεταξύ των εργαζομένων γίνεται είτε προφορικά είτε μέσα από σημειώσεις και φύλλα νοσηλείας. Όπως είναι φυσικό, κατά την μεταφορά των πληροφοριών/οδηγιών πολλές φορές είτε δεν γίνονται κατανοητές από τους ίδιους τους εργαζόμενους, είτε μεταφέρονται λάθος. Σε κάθε περίπτωση, η σχέση μεταξύ του πομπού και του δέκτη επηρεάζει την ποιότητα των πληροφοριών αυτών. Αν για παράδειγμα ο νοσηλευτής φοβάται και έχει κακές προηγούμενες εμπειρίες, είναι πιθανό να μην δώσει πολλές πληροφορίες ή να μην ζητήσει και περαιτέρω διευκρινήσεις. Με αυτόν τον τρόπο, δημιουργούνται προβλήματα με τις ασαφείς και πολύπλοκες οδηγίες των ιατρών, περιορίζοντας αυτόματα την ισότιμη και ελεύθερη έκφραση.

Είναι προφανές πως η έλλειψη ορθών πληροφοριών μπορεί να οδηγήσει σε (ενδεχομένως) ανεπιθύμητα συμβάντα και επακόλουθη βλάβη του ασθενούς. Επίσης, η κακή επικοινωνία συχνά προκαλεί αρκετούς τύπους καθυστερήσεων, όπως η απάντηση στη διαβούλευση ή η αποδοχή μιας παραπομπής και της θεραπείας (Durbin et al. 2012). Ως συνέπεια, η ασφάλεια των ασθενών ενδέχεται να διακυβευτεί όταν οι σωστές πληροφορίες δεν είναι διαθέσιμες στο σωστό άτομο την κατάλληλη στιγμή (Kaelber & Bates, 2007). Για τους παρόχους υγειονομικής περίθαλψης, η κακή επικοινωνία οδηγεί σε πρόσθετο φόρτο εργασίας, καθώς μειώνει την εμπιστοσύνη στις αποφάσεις (Jiwa & Dhaliwal, 2012). Από την άλλη, οι ασθενείς μπορούν να

αντιμετωπίσουν την ανάγκη να υποβληθούν σε διπλές εξετάσεις, η και να καθυστερήσουν τις θεραπείες τους. Μια τέτοια κατάσταση ενδέχεται να οδηγήσει σε αυξημένο, περιττό και αποφευκτό κόστος, π.χ. λόγω περιττών επανειλημμένων ερευνών (Erstein, 1995).

Ένας άλλος παράγοντας που υπονομεύει την αποτελεσματική επικοινωνία είναι οι δύο ξεχωριστές επαγγελματικές κουλτούρες ιατρών-νοσηλευτών. Οι νοσηλευτές, περνώντας περισσότερο χρόνο με τον ασθενή επικεντρώνονται περισσότερο και στην φροντίδα του ασθενή, δίνοντας παράλληλα βάση στην διεξαγωγή μιας αποτελεσματικής επικοινωνίας με τον ιατρό (Schmidt & Svarstad, 2002). Από την άλλη, οι ιατροί δίνοντας μεγαλύτερη βάση στην θεραπεία του ασθενή και όχι στην φροντίδα, ενδιαφέρονται περισσότερο για την λήψη δομημένων πληροφοριών από τους νοσηλευτές.

Στον τομέα της υγειονομικής περίθαλψης, ο ρόλος του ιατρικού και νοσηλευτικού προσωπικού είναι περίπλοκη. Για αυτό εμφανίζονται ασάφειες στους ρόλους μεταξύ των συναδέλφων, δημιουργώντας εχθρότητα και έλλειψη συνεργασίας μεταξύ τους. Αυτές οι αρνητικές διαπροσωπικές σχέσεις/συγκρούσεις μπορεί να οδηγήσουν στην μείωση της εργασιακής ικανοποίησης, στην μη αποτελεσματική επικοινωνία, και στην μη αποδοτικότητα του οργανισμού.

Τέλος, ένας από τους συνηθέστερους λόγους που ευθύνεται για την προβληματική επικοινωνία μεταξύ των εργαζομένων είναι ο φόρτος εργασίας. Σημαντικό πρόβλημα αποτελεί και η έλλειψη χρόνου από πλευράς του ιατρικού και νοσηλευτικού προσωπικού, λόγω κυρίως του φόρτου εργασίας και της έλλειψης προσωπικού στα δημόσια νοσοκομεία (Μαλτσάκη, 2014). Ταυτόχρονα, το εργασιακό ωράριο είναι έντονο και κουραστικό με εικοσιτετράωρες εφημερίες κατά τις οποίες δεν είναι λίγες οι φορές που παραμένουν εντελώς άπυνοι εξαιτίας αυτού.

### **Εμπόδια στην επικοινωνία ιατρικού προσωπικού-ασθενή**

Όπως ήδη αναφέρθηκε πιο πάνω, στον χώρο της υγείας δημιουργούνται συχνά προστριβές και αντιπαραθέσεις μεταξύ των επαγγελματιών, επηρεάζοντας με αρνητικό τρόπο την μεταξύ τους επικοινωνία. Εντούτοις, η ελλιπής επικοινωνία δεν εντοπίζεται μόνο μεταξύ των επαγγελματιών υγείας, αλλά και ανάμεσα στην σχέση του ιατρού με τον ασθενή. Εκτιμάται ότι το 70–80% των περιπτώσεων παραπομπής ιατρών στα δικαστήρια αφορούν σε θέματα σχέσης ιατρού-ασθενούς, καθώς και σε προβλήματα επικοινωνίας και λιγότερο σε ζητήματα ιατρικών λαθών (Lussier & Richard, 2005).

Αναλυτικότερα, η επικοινωνία μεταξύ επαγγελματία υγείας και ασθενή περιλαμβάνει (Μπελλάλη, 2018): τη γνωριμία, τον εντοπισμό του προβλήματος υγείας, την εξέταση του προβλήματος, το συνεργατικό προγραμματισμό, την αξιολόγηση παροχής φροντίδας, τον προσδιορισμό των αναγκών, τη νοσηλεία, την αξιολόγηση σε συνεργασία με τον ασθενή και τη θεραπευτική ομάδα, το αποτέλεσμα της φροντίδας, κ.α.

Σύμφωνα με την μελέτη των Roter, Stewart, Putnam και Lipkin (1997), υπάρχουν πέντε διαφορετικά μοντέλα που καθορίζουν την σχέση ιατρού-ασθενή. Τα μοντέλα αυτά είναι:



- το αυστηρά βιοϊατρικό, στο οποίο περιλαμβάνονται ερωτήσεις κλειστού τύπου που στοχεύουν μονάχα σε ιατρικά θέματα
- το διευρυμένο βιοϊατρικό, στο οποίο οι ερωτήσεις του γιατρού θίγουν ψυχοκοινωνικά ζητήματα
- το βιοψυχοκοινωνικό, στο οποίο ο γιατρός, μέσα από την χρήση ανοιχτών ερωτήσεων, θίγει ιατρικά και ψυχοκοινωνικά ζητήματα
- το ψυχοκοινωνικό, στο οποίο ο γιατρός εστιάζοντας στους ψυχοκοινωνικούς παράγοντες, προσπαθεί να μελετήσει το πώς επηρεάζει την γενικότερη υγεία του ασθενή
- το καταναλωτικό, στο οποίο ο γιατρός έχει τον ρόλο του ειδικού που απαντά σε ερωτήσεις και ικανοποιεί τις προσδοκίες του ασθενή-καταναλωτή

Επί της ουσίας τα μοντέλα αυτά αντικατοπτρίζουν δύο αντιπαραθετικές ιδεολογίες για την άσκηση της ιατρικής: η μια που τοποθετεί το γιατρό σε απόσταση από τον ασθενή ώστε να παρατηρεί αντικειμενικά τα κλινικά σημεία και η άλλη που ενθαρρύνει το γιατρό να χρησιμοποιεί τα συναισθήματά του για να προσεγγίσει τα βιώματα του ασθενή (Philips, 1996).

Σήμερα, το κυρίαρχο μοντέλο που κυριαρχεί στα νοσοκομεία, είναι αυτό του βιοϊατρικού. Σε μια σειρά χωρών (ΗΠΑ, Αγγλία, Ελλάδα, κ.α.) έχουν επισημανθεί προβλήματα σχετικά με την ποιότητα της επικοινωνίας (Derick & Halligan, 2005). Συγκεκριμένα, η έλλειψη της επικοινωνίας οδηγεί τους γιατρούς σε μια μονόπλευρη ανάλυση ενός προβλήματος, εφόσον εστιάζοντας μόνο στο άμεσο σωματικό πρόβλημα, αποκλείουν αυτόματα ψυχοκοινωνικούς παράγοντες που συμβάλουν σε αυτό, και εν τέλει αυτό οδηγεί στο να αντιμετωπίζονται οι ασθενείς ως “αριθμοί” (Fuqing et al. 2015).

Κατά τις τελευταίες δεκαετίες, το ενδιαφέρον των επαγγελματιών υγείας στρέφεται ολοένα και περισσότερο στην ικανοποίηση των ασθενών από την παρεχόμενη φροντίδα υγείας, εφόσον αποτελεί έναν έγκυρο δείκτη της ποιοτικής φροντίδας. Αξιολογώντας και ικανοποιώντας τις προσδοκίες των ασθενών, επιτυγχάνεται μία βασική συνεργασία, η οποία αποτελεί προϋπόθεση για την παροχή υψηλής ποιότητας φροντίδας. Η μέτρηση της ικανοποίησης των ασθενών χρησιμοποιείται κυρίως στην αξιολόγηση της ποιότητας των προσφερόμενων υπηρεσιών. Οι ασθενείς είναι δυνατό να δώσουν πληροφορίες, οι οποίες αν αξιοποιηθούν σωστά μπορούν να συνεισφέρουν στην ποιοτική βελτίωση των υπηρεσιών (Κοτσαγιώργη & Γκέκα, 2010).

Η έρευνα της Μ. Καλογεροπούλου (2011), της οποίας σκοπός ήταν η μέτρηση της ικανοποίησης των ασθενών από τις παρεχόμενες υπηρεσίες υγείας 6 γενικών δημόσιων νοσοκομείων της Αθήνας (και συγκεκριμένα της Αττικής) και η εκτίμηση του χάσματος μεταξύ των προσδοκιών των ασθενών και της πραγματικής αποδοτικότητας των νοσοκομείων, προσφέρει ενδιαφέροντα ευρήματα. Για τη μέτρηση της ικανοποίησης των χρηστών των υπηρεσιών υγείας επιλέχθηκε δείγμα 300 ατόμων με τη μέθοδο της στρωματοποιημένης τυχαίας δειγματοληψίας, και το ποσοστό ανταπόκρισης των ερωτηθέντων διαμορφώθηκε στο 71%, δηλαδή σε 215 άτομα. Σύμφωνα με την έρευνα αυτή, συνολικά το 67% των ασθενών δεν έμεινε καθόλου ικανοποιημένο από

την ενημέρωση που τους παρείχε το νοσοκομείο σχετικά με το πρόβλημα υγείας, τη διάγνωση, τη θεραπεία και τις πιθανές δυνατότητες αντιμετώπισής του, καθώς ανέφεραν παραβίαση των δικαιωμάτων λήψης συγκατάθεσης για διαγνωστικές και θεραπευτικές πράξεις. Το 57,3% των ασθενών εμφανίστηκε απόλυτα ικανοποιημένο από τον χρόνο εισαγωγής στο νοσοκομείο και το 32,7% από την παροχή αποτελεσματικής φροντίδας, ενώ το 27,1% ανέφερε παραβιάσεις του ιατρικού απορρήτου. Ποσοστό 82,7% ανέφερε παράπονα σχετικά με τις συνθήκες καθαριότητας, διαμονής και την ποιότητα του φαγητού, ενώ το 74,4% των ασθενών δεν έμειναν καθόλου ικανοποιημένοι από τη συμπεριφορά του προσωπικού του νοσοκομείου. Η ελλιπής επικοινωνία και η μη ικανοποίηση του ασθενούς είναι παράμετροι που συνδέονται άρρηκτα με την πιθανότητα καταγγελίας ιατρικών λαθών (Βενιού & Ταντολούρης, 2013).

Το ζήτημα που έχει απασχολήσει έντονα την επιστημονική κοινότητα τα τελευταία χρόνια, είναι η αναζήτηση των παραγόντων που συμβάλλουν σε αυτήν την αντιμετώπιση των ασθενών από μέρος των ιατρών. Ένα από τα προβλήματα που έχουν επισημανθεί είναι η έλλειψη χρόνου από πλευράς του ιατρικού και νοσηλευτικού προσωπικού, λόγω κυρίως του φόρτου εργασίας και της έλλειψης προσωπικού στα δημόσια νοσοκομεία (Κοϊνης & Σαρίδη, 2014). Γενικότερα, το εργασιακό ωράριο είναι έντονο και κουραστικό με εικοσιτετράωρες εφημερίες κατά τις οποίες δεν είναι λίγες οι φορές που παραμένουν εντελώς άυπνοι. Ως αποτέλεσμα αυτού, οι γιατροί δεν λαμβάνουν την πρέπουσα προσοχή για το εάν οι ασθένειες τους έχουν καταλάβει τα όσα έχουν λεχθεί, μη δίνοντας ταυτόχρονα τον απαραίτητο χρόνο για ερωτήσεις (Χάρος κ.ά. 2017).

Αντίστοιχα, η επαγγελματική εξουθένωση είναι ένα φαινόμενο που συναντάται πιο έντονα με την πάροδο του χρόνου, και για αυτό συγκαταλέγεται ανάμεσα στα τέσσερα συχνότερα αναφερόμενα προβλήματα που σχετίζονται με την προσφορά εργασίας στην Ευρώπη (Σαλμάν & Πλατσίδου, 2002). Ιδιαίτερα, τα τμήματα που νοσηλεύουν ασθενείς με αυξημένες ανάγκες φροντίδας (όπως τα Ογκολογικά Νοσοκομεία), οι νοσηλευτές καλούνται να υποδείξουν και να υποστηρίξουν μία νέα «ποιότητα ζωής» στον άρρωστο, και μετά από μεγάλο διάστημα φροντίδας να αντιμετωπίσουν και την απώλεια της ζωής του (Grunfeld et al. 2000). Οι επαγγελματίες υγείας επιφορτίζονται συναισθηματικά και οδηγούνται σε εξάντληση όταν δεν είναι κατάλληλα προετοιμασμένοι ή δεν έχουν το χρόνο και τη δυνατότητα να βιώσουν και να επεξεργαστούν τις συχνές απώλειες (Τσαντήλα, 2010). Στον χώρο της εργασίας, αυτοί που έχουν δεχθεί επαγγελματική εξουθένωση έχουν αυξημένη πιθανότητα να μην απαντήσουν στις ερωτήσεις των ασθενών τους, να μην τους ενημερώσουν για τις θεραπευτικές επιλογές τους, άλλα ενδέχεται να κάνουν και ιατρικά λάθη (Τσαντήλα, 2020).

Επιπρόσθετα, έχει αναφερθεί πως οι γιατροί αποκτούν μια στάση αποφυγής απέναντι στους ασθενείς τους (Ναούμ, 2018). Πολλές φορές, λόγω του ότι θέλουν να αποφύγουν την συναισθηματική σύνδεση με τον ασθενή τους, και να μην φέρουν τους εαυτούς τους σε δύσκολη θέση, απομακρύνονται από αυτούς. Η κατάσταση αυτή επηρεάζει αρνητικά τους γιατρούς, συντελώντας στην αύξηση της ταλαιπωρίας των ασθενών (DiMatteo & Martin, 2011).

Η έλλειψη ενεργητικού τρόπου ακρόασης από τον ιατρό δημιουργεί επίσης σημαντικά προβλήματα. Υπολογίζεται ότι στην πλειοψηφία των συναντήσεων το 50% περίπου από τα προβλήματα που απασχολούν

τον ασθενή δεν αναφέρονται, ενώ κατά μέσο όρο οι ιατροί διακόπτουν τους ασθενείς σε λιγότερο από 20 δευτερόλεπτα από τη στιγμή που αρχίζουν να αναλύουν το σκοπό της επίσκεψής τους (Καραμανίδου, 2010). Η κατάσταση αυτή, όπως είναι φυσικό, προκαλεί δυσαρέσκεια στους ασθενείς (Gude et al. 2013).

Ακόμη, οι γιατροί που εργάζονται σε πολυπολιτισμικές κοινωνίες, αναλαμβάνουν συχνά ασθενείς από διαφορετικές εθνικές ομάδες. Οι πολιτισμικές διαφορές μεταξύ ιατρών και ασθενών προκαλούν την μη αποτελεσματικότητα στην επικοινωνία και στην ποιότητα της φροντίδας, λόγω προβλημάτων επικοινωνίας που οδηγούν σε χαμηλότερα επίπεδα αμοιβαία κατανόηση και λιγότερη ικανοποίηση (Μποστανίτης & Τσαλίδου, 2010). Οι διαπολιτισμικές επαφές γιατρού-ασθενούς είναι δυνητικές πηγές παρεξήγησης και επικοινωνίας χαμηλής ποιότητας, οι οποίες ενδέχεται να μειώσουν την ποιότητα της περίθαλψης. Μια πιθανή επίδραση στην ποιότητα της επικοινωνίας των ασθενών είναι ότι πολλοί γιατροί αισθάνονται ότι είναι ανίκανοι να επικοινωνούν και να σχετίζονται με ασθενείς διαφορετικού εθνικού πλαισίου λόγω έλλειψης επαρκών δεξιοτήτων, γλωσσικών εμποδίων ή γνώσης επικοινωνίας με αυτούς τους ασθενείς (Μποστανίτης & Τσαλίδου, 2010).

Κρίσιμη παράμετρο για την τελική θεραπευτική εκροή αποτελεί η προσαρμογή του ασθενούς στις ιατρικές οδηγίες. Τα δεδομένα δείχνουν (DiMatteo, 2004) ότι η πιστή τήρησή τους αυξάνει το θεραπευτικό αποτέλεσμα κατά 26%. Απαραίτητο στοιχείο προκειμένου ο ασθενής να ακολουθήσει τις συστάσεις της θεραπείας, αποτελεί η πλήρης κατανόηση της αξίας τους, το οποίο επιτυγχάνεται με την υποβολή ερωτήσεων γύρω από την θεραπευτική διαδικασία (Τσουνής & Σαράφης, 2014). Ωστόσο, αρκετές φορές οι ιατροί επαναπαύονται λόγω του γεγονότος ότι οι ασθενείς τις αποφεύγουν, θεωρώντας λανθασμένα ότι δεν έχουν συγκεκριμένες απορίες σχετικά με τις θεραπευτικές οδηγίες (Τσουνής & Σαράφης, 2014). Η έλλειψη επαρκών εξηγήσεων οδηγεί σε κακή κατανόηση-αφομοίωση της θεραπευτικής αγωγής από τους ασθενείς και σε έλλειψη συναίνεσης μεταξύ του γιατρού-ασθενή, με τελικό αποτέλεσμα τη θεραπευτική αποτυχία (Παναγοπούλου & Μπένος, 2004).

Επίσης, η διαφορά μορφωτικού επιπέδου είναι ένας ακόμη παράγοντας που οδηγεί στην αναποτελεσματική επικοινωνία. Μελέτες έχουν δείξει πως τα άτομα με ανώτερη εκπαίδευση έχουν, τις περισσότερες φορές, τη μέγιστη πληροφόρηση πριν από την επίσκεψη στον ιατρό τους, ενώ η χαμηλή κοινωνική τάξη και η μειονότητα συχνά δυσκολεύονται να κατανοήσουν τους ιατρικούς όρους, όπως δυσκολεύονται να εκθέσουν το πρόβλημά τους στον ιατρό (Παναγοπούλου & Μπένος, 2004).

Παρότι στις μέρες μας οι πολίτες είναι καλύτερα πληροφορημένοι σχετικά με υγειονομικά θέματα από διάφορες πηγές (όπως είναι το διαδίκτυο), εξακολουθεί να υπάρχει μια σημαντική ασυμμετρία γνώσης και πληροφόρησης ανάμεσα στον γιατρό και στον ασθενή (Cline, 2003). Στο διαδικτυακό χώρο μπορεί κανείς να βρει εύκολα και γρήγορα ιατρικές ιστοσελίδες δημιουργημένες από ιατρούς με πληροφορίες για κάθε ασθένεια και θεραπεία, καταλόγους εύρεσης ιατρών, εφημερευόντων νοσοκομείων και ιατρικών κλινικών κ.λπ (Ρουμελιωτάκη & Χρονάκη, 2009)<sup>46</sup>. Η λανθασμένη χρήση του διαδικτύου εγκυμονεί τον κίνδυνο της παραπληροφόρησης, καθώς ο αριθμός των δημοσιεύσεων για θέματα υγείας αυξάνεται δραματικά τα

τελευταία χρόνια (Ρουμелиωτάκη & Χρονάκη, 2009). Αυτό, ωστόσο, που προκαλεί ένα βαθμό ανησυχία είναι το γεγονός ότι αρκετοί ασθενείς συμβουλευόταν το διαδίκτυο για να διαγνώσουν οι ίδιοι το νόσημα από το οποίο πάσχουν χωρίς να καταφύγουν στη γνώμη ενός ειδικού.

### **Μέτρα για την αποτελεσματική επικοινωνία**

Είναι εμφανές πως στον χώρο ενός νοσοκομείου που διενεργούνται πολύπλοκες διαδικασίες, απαιτείται συνεχής βελτίωση των ικανοτήτων του ιατρονοσηλευτικού προσωπικού και την εφαρμογή μέτρων για την επίλυση των πραγματικών προβλημάτων που διέπουν τον χώρο. Προκειμένου να επιτευχθεί αυτό, θα πρέπει να εξασφαλιστεί η αποτελεσματική επικοινωνία, τόσο μεταξύ των επαγγελματιών υγείας, όσο και με τους ασθενείς. Από την μία είναι επιτακτική η ανάγκη της αποτελεσματικής επικοινωνίας με τους ασθενείς για την εκτίμηση της κατάστασης τους, την ακρίβεια της διάγνωσης και την επιλογή της κατάλληλης θεραπευτικής παρέμβασης, και από την άλλη είναι αναγκαία η αποτελεσματική επικοινωνία μεταξύ ιατρών-νοσηλευτών, προκειμένου να παρέχουν ολοένα και καλύτερες υπηρεσίες στους ασθενείς. Με την συνεργασία είναι δυνατό να αποφευχθούν τα ιατρικά λάθη, να εξασφαλιστεί η ασφάλεια των ασθενών, να ελαχιστοποιηθεί η σπατάλη των πόρων, και οι ασθενείς να κατανοήσουν πλήρως τις ιατρικές οδηγίες.

Αναλυτικότερα, όσον αφορά τη σχέση μεταξύ ιατρών-νοσηλευτών, η πραγματοποίηση ανά τακτά χρονικά διαστήματα προγραμματισμένων συναντήσεων, υπό την καθοδήγηση του διευθυντή του τμήματος/κλινικής, αναμένεται να καλλιεργήσει ένα θετικό κλίμα εμπιστοσύνης και αλληλοσεβασμού ανάμεσα στους ιατρούς και τους νοσηλευτές (Μαλτσάκη, 2014). Με αυτόν τον τρόπο μπορούν να ανοικοδομηθούν συναισθήματα και αξίες όπως είναι ο σεβασμός, η αρμονική συνεργασία, η αλληλοκατανόηση κ.λπ. Η καλή διεπαγγελματική συνεργασία και ο σωστός καταμερισμός εργασίας μεταξύ των εργαζομένων, αφενός δημιουργούν ένα ευχάριστο περιβάλλον κατά την διάρκεια της εργασίας, και αφετέρου ωφελούν σημαντικά την υγεία του ασθενή (Τσουνής & Σαράφης, 2014).

Η μάθηση και η επαγγελματική ανάπτυξη είναι καθοριστικής σημασίας για τη βελτίωση των συνολικών δεξιοτήτων επικοινωνίας. Τα επιμορφωτικά σεμινάρια έχουν ως στόχο την αποδοτικότερη επικοινωνία μεταξύ ιατρών και ασθενούς, επιφέροντας έτσι την αύξηση του επιπέδου υγείας του ασθενούς (Τσουνής & Σαράφης, 2014). Στόχοι των σεμιναρίων συνεχιζόμενης εκπαίδευσης, που πραγματοποιούνται πολύ συχνά στο εξωτερικό, είναι (Μπελλάλη, 2018): να τονίσουν τον σημαντικό ρόλο της επικοινωνίας στο χώρο της υγείας, να εκτιμήσουν τη σημασία της λεκτικής και μη λεκτικής επικοινωνίας, να εντοπίσουν τους φραγμούς επικοινωνίας, να αναπτύξουν αποτελεσματικές δεξιότητες ενεργητικής ακρόασης στην επικοινωνία με τους ασθενείς, κ.λπ. Τα παραπάνω σεμινάρια θα μπορούσαν να πραγματοποιηθούν, πέραν με τις κλασικές μεθόδους (π.χ. διαλέξεις), με μεθόδους ενεργητικής μάθησης και αλληλεπίδρασης (π.χ. εκπαιδευτικών βιντεοταινιών με πραγματικούς ή κατά «προσομοίωση» ασθενείς, τα κλινικά σεμινάρια, μέσα από παιχνίδια-ρόλους κ.λπ) (Βενιού & Ταντολούρης, 2013). Επιπρόσθετα, αυτού του είδους η συνεχιζόμενη εκπαίδευση θα μπορούσε να επικεντρωθεί στην εκμάθηση συγκεκριμένων πρωτόκολλων/κλινικών κατευθυντήριων οδηγιών στο πνεύμα της Τεκμηριωμένης Κλινικής Πρακτικής. Παραδείγματα αποτελούν:

- το CLASS (Context, Listening skills, Acknowledge, Strategy, Summary), που αφορά την διαδικασία λήψης του ιατρικού ιστορικού
- το CONES (Context, Opening Shot, Narrative, Emotions, Strategy & Summary), που έχει να κάνει με τον τρόπο προσέγγισης του ασθενή και της οικογένειας του στην περίπτωση ιατρικού λάθους
- το BALANCE (Beliefs & Values, Ambience, Language & Health Literacy, Affiliations, Network, Challenges, Economics), που αφορά τις διαπολιτισμικές διαφορές ασθενή-ιατρού
- το SPIKES (Setting, Perception, Invitation, Knowledge, Emotions, Support), που εστιάζει στον τρόπο ανακοίνωσης δυσάρεστων νέων σε ασθενείς με σοβαρή για τη ζωή νόσο

Επιπρόσθετα, ο τρόπος που μεταβιβάζεται μια πληροφορία από τον ιατρό στον ασθενή είναι τόσο σημαντικός όσο και η ίδια η πληροφορία (Kidd et al. 2005). Σημαντικό τμήμα της επικοινωνίας καταλαμβάνουν οι μη λεκτικές ενδείξεις. Στοιχεία όπως οι εκφράσεις του προσώπου, ο τόνος της φωνής, οι κινήσεις και οι στάσεις του σώματος, επηρεάζουν σημαντικά τη νοηματοδότηση και την ερμηνεία του μηνύματος. Η μη λεκτική πλευρά της αλληλεπίδρασης αποτελεί μια εξαιρετική πηγή πληροφοριών, τόσο για τον ιατρό όσο και για τον ασθενή (Hannawa, 2011). Συνεπώς, ο ιατρός πρέπει να δίνει ιδιαίτερη έμφαση στη μη λεκτική πλευρά των μηνυμάτων.

Τέλος, μια πολύ ενδιαφέρουσα μέθοδος που ολοένα και περισσότερο χρησιμοποιείται στον ιατρικό χώρο είναι το Teach-back-Method. Ανεξάρτητα από το επίπεδο γνώσης ενός ασθενούς σχετικά με θέματα υγείας, είναι σημαντικό το προσωπικό να διασφαλίζει ότι οι ασθενείς κατανοούν τις πληροφορίες που τους έχουν δοθεί. Η μέθοδος διδασκαλίας είναι ένας τρόπος για τον έλεγχο της κατανόησης ζητώντας από τους ασθενείς να δηλώσουν με δικά τους λόγια τι πρέπει να γνωρίζουν ή να κάνουν για την υγεία τους. Η σχετική μέθοδος απεικόνισης επιτρέπει στο προσωπικό να επιβεβαιώσει ότι οι ασθενείς είναι σε θέση να ακολουθήσουν συγκεκριμένες οδηγίες (π.χ. το ποιος τροφές θα πρέπει να αποφύγουν κατά την περίοδο λήψης ενός φαρμάκου, το πώς να χρησιμοποιούν μια συσκευή εισπνοής κ.λπ.) (Schillinger et al. 2003). Η σημασία της μεθόδου αυτής ενισχύεται μέσα από μελέτες<sup>50</sup> που δείχνουν πως το 40-80% των ιατρικών πληροφοριών των ασθενών που ενημερώνονται κατά τη διάρκεια της ιατρικής επίσκεψης, ένα μεγάλο κομμάτι των πληροφοριών που έχουν δοθεί λησμονούνται αμέσως, και σχεδόν οι μισές από τις πληροφορίες διατηρούνται είναι λανθασμένες.

### **Συμπεράσματα**

Η επικοινωνιακή δεξιότητα του επαγγελματία υγείας δεν πρέπει να θεωρείται ως κάτι αυτονόητο ή δευτερεύον. Οι δεξιότητες επικοινωνίας τόσο μεταξύ των εργαζομένων, όσο και μεταξύ του ιατρικού προσωπικού και του ασθενή, θεωρούνται μείζονος σημασίας για τους επαγγελματίες υγείας, αν και συχνά η αξία τους παραγνωρίζεται.

Τα οφέλη από την αποτελεσματική επικοινωνία μεταξύ του ιατρικού και μη ιατρικού προσωπικού είναι ποικίλα: πρόληψη των ασθενειών, βελτίωση των σχέσεων μεταξύ ιατρικού προσωπικού και ασθενών, ευκολότερη κίνηση δημόσιων και ατομικών πληροφοριών σχετικά με τον κίνδυνο για την υγεία, διαμόρφωση

μηνυμάτων δημόσιας υγείας, αλλαγή της συμπεριφοράς υγείας προς αυτό το μονοπάτι, παροχή εκπαίδευσης στον πληθυσμό σχετικά με τον τρόπο πρόσβασης στο σύστημα παροχής υγειονομικής περίθαλψης, προαγωγή της υγείας και της ποιότητας ζωής, βελτιώσει των κλινικών αποτελεσμάτων, αύξηση του βαθμού ικανοποίησης των ασθενών, συμβάλλει στη μείωση των δαπανών σε ανθρώπινους και υλικούς πόρους, μείωση των σοβαρών ιατρικών λαθών κ.λπ.

Παρόλα αυτά, το εγχείρημα αυτό συναντά συχνά δυσκολίες ως προς την υλοποίησή του. Η εύρυθμη συνεργασία μεταξύ των επαγγελματιών υγείας μπορεί να διαταραχθεί μέσα από τις συγκρούσεις. Συγκρούσεις δημιουργούνται σε περιπτώσεις όπου υπάρχει ασυμφωνία απόψεων, αξιών, ασυμβατότητα αναγκών και στόχων, μέσα από τις ανισότητες στην κατανομή της εξουσίας, την ασάφεια σχετικά με τους ρόλους και τις αρμοδιότητες τους, τον

σηματισμό κλειστών ομάδων με κοινά χαρακτηριστικά, τα στερεότυπα σχετικά με την ανωτερότητα του ιατρικού επαγγέλματος, κ.λπ. Αντίστοιχα, η σχέση των επαγγελματιών υγείας με τους ασθενείς τους μπορεί εξίσου να διαταραχθεί. Η χρήση του βιοιατρικού μοντέλου, που κυριαρχεί στα περισσότερα νοσοκομεία σε μια σειρά χωρών, δημιουργεί προβλήματα στην ποιότητα της επικοινωνίας, εφόσον προσφέρει μια μονόπλευρη ανάλυση ενός προβλήματος. Άλλοι λόγοι που οδηγούν σε τέτοιο μεγάλο χάσμα ως προς την επικοινωνία είναι η διαφορά μορφωτικού επιπέδου, η στάση αποφυγής των γιατρών απέναντι στους ασθενείς τους, η έλλειψη ενεργητικού τρόπου ακρόασης από τον ιατρό κ.λπ.

Η αποτελεσματική επικοινωνία μεταξύ των ατόμων εξαρτάται από μια σειρά παραγόντων, όπως είναι: από τις επιθυμίες που έχουν τα άτομα (που συχνά διαφέρουν), το πώς εκλαμβάνουν τα διάφορα μηνύματα (από τον πομπό προς τον δέκτη), από την θέληση που έχουν τα άτομα να ακούσουν τους άλλους, κλπ. Παρόλα αυτά, η έλλειψη εναρμόνισης ανάμεσα στις πεποιθήσεις ή τους στόχους που έχουν οι ασθενείς και το προσωπικό μπορεί να οδηγήσει σε σημαντικές δυσκολίες στην επικοινωνία.

Η επικοινωνία στον τομέα της υγείας έχει πολλά να προσφέρει. Το πεδίο αυτό ολοένα και αναγνωρίζεται από την επιστημονική κοινότητα εν μέρει λόγω της έμφασης που δίνει στο συνδυασμό της θεωρίας και της πρακτικής στην κατανόηση των διαδικασιών επικοινωνίας και στην αλλαγή της ανθρώπινης συμπεριφοράς. Συνδυάζοντας ερευνητές και επαγγελματίες από διάφορους κλάδους και υιοθετώντας θεωρητικές προσεγγίσεις πολλαπλών επιπέδων, οι υπεύθυνοι της υγείας έχουν μοναδική ευκαιρία να παράσχουν ουσιαστική συμβολή στη βελτίωση και τη διάσωση ζωών. Αναμφίβολα, τόσο οι εργαζόμενοι όσο και οι ασθενείς οφείλουν να υπερπηδήσουν τα εμπόδια που δημιουργούνται στην μεταξύ τους επικοινωνίας, με σκοπό την εύρυθμη λειτουργία του ίδιου του συστήματος.

## **Βιβλιογραφία**

- Βενιού, Α., & Ταντολούρης, Τ. (2013). Παράγοντες που επηρεάζουν την επικοινωνία ιατρού-ασθενούς. *Αρχαία Ελληνικής Ιατρικής*, 30: 613-618.
- Betancourt, J.R. (2006). Cultural competence and medical education: many names, many perspectives, one goal. *Academic medicine: journal of the Association of American Medical Colleges*, 499-501.

- Cline, J.I. (2003). Collaborative care of individuals. In: Molu, W. (Ed.), *Psychiatric mental health warning* (6<sup>th</sup> ed.). Philadelphia Lippincott, Williams & Wilkins, pp 171-188.
- Derick, T. W. & Halligan, P. W. (2005). Do Biomedical Models Of Illness Make For Good Healthcare Systems? *BMJ Publishing Group*. 329: 1398-1401.
- DiMatteo, M. R. (2004). Variations in patients' adherence to medical recommendations: *A quantitative review of 50 years of research*, 42: 200-209.
- DiMatteo, M. R. & Martin, L. R. (2011). *Εισαγωγή στην Ψυχολογία της Υγείας*. Αθήνα: Εκδόσεις Πεδίο.
- Durbin, J., Barnsley, J., Finlayson, B., Jaakkimainen, L., Lin, E., Berta, W., & McMurray, J. (2012). Quality of communication between primary health care and mental health care: an examination of referral and discharge letters. *The journal of behavioral health services & research*, 39: 445-61.
- Epstein, R. M. (1995). Communication between primary care physicians and consultants. *Archives of family medicine*, 4: 403-9.
- Essays, UK. (November 2018). *The Importance Of Health Communication*. Available at: <https://www.ukessays.com/essays/health-and-social-care/importance-of-health-communication-health-and-social-care-essay.php?vref=1>
- Farell, G. (2001). From tall poppies to squashed weeds: why won't nurses pull together more?. *Journal of advanced nursing*, 35: 26-33.
- Feng, H., Danfelter, M., Strömqvist, B. & Heinegård, D. (2006). Extracellular matrix in disc degeneration. *The Journal of Bone and Joint Surgery-American*, 88: 25-29.
- Φουντούκη, Α., Γκατζέλης, Θ., Πάντας, Δ., & Θεοφανίδης, Δ. (2009). Η διεπαγγελματική συνεργασία του νοσηλευτή στο εργασιακό περιβάλλον ενός επαρχιακού νοσοκομείου. *Το Βήμα του Ασκληπιού*, 4: 336-352.
- Fuqing, G., Yunpeng, D., Taowen, P., Min, L. & Hongliang, S. (2015). Evolution of human medical model and development course of medical humanistic spirit. *Biomedical Research*, 26 (3).
- Grunfeld, E. Whelan, T.J., Zitzelsberger, L. Willan, A.R., Montesanto, B. & Evans, W.K. (2000). Cancer care workers in Ontario: prevalence of burnout, job stress and job satisfaction. *Canadian Medical Association journal*, 3: 166-169.
- Gude, T., Vaglum, P., Anvik, T., Bærheim, A., & Grimstad, H. (2013). A few more minutes make a difference? The relationship between content and length of GP consultations. *Scandinavian journal of primary health care*, 31: 31-35.
- Hannawa, A. F. (2011). Shedding light on the dark side of doctor-patient interactions: Verbal and non-verbal messages physicians communicate during error disclosures. *Patient education and counseling*, 84: 344-35.
- Jiwa, M. & Dhaliwal, S. (2012). Referral writer: preliminary evidence for the value of comprehensive referral letters. *Quality in primary care*, 20: 39-45.
- Joint Commission Perspectives. (2012). Joint Commission Center for Transforming Healthcare Releases Targeted Solutions Tool for Hand-Off Communications. *Joint Commission on Accreditation of Healthcare Organizations*, 32: 8.
- Kaelber, D.C. & Bates, D.W. (2007). Health information exchange and patient safety. *Journal of biomedical informatics*, 40: 40-5.
- Καλογεροπούλου, Μ., & Μουρδουκούτας, Π. (2007). *Υπηρεσίες Υγείας*. Αθήνα: Εκδόσεις Κλειδάριθμος.
- Καραμανίδου, Χ. (2010). Επικοινωνία επαγγελματιών υγείας και ασθενών και το φαινόμενο της μη συμμόρφωσης: Προσανατολισμοί για την πολιτική υγείας. Στο: Κοντιάδης Ξ, Σουλιώτης Ν (Επιμ.) *Θεσμοί και πολιτικές υγείας*. Αθήνα: Εκδόσεις Παπαζήση.
- Kidd, J., Patel, V., Peile, E., & Carter, Y. (2005). Clinical and communication skills. *British Medical Association*, 330: 374-375.
- Κοΐνης, Α. & Σαρίδη, Μ. (2014). Εργασιακό στρες και η επίδρασή του στην επαγγελματική και προσωπική ζωή των Επαγγελματιών Υγείας. *Το Βήμα του Ασκληπιού*, 13, (4).
- Κοτσαγιώργη, Ι. & Γκέκα, Κ. (2010). Ικανοποίηση ασθενών από την παρεχόμενη φροντίδα υγείας. *Το Βήμα του Ασκληπιού*, 4: 399-408.
- Κρανάκη, Μ. Σ. (2016). *Διαχείριση συγκρούσεων στο εργασιακό χώρο-Conflict management in the workplace* (Πτυχιακή εργασία). Πειραιάς: Α.Ε.Ι Πειραιά Τ.Τ – Ανώτατο Εκπαιδευτικό Ίδρυμα Πειραιά Τεχνολογικού Τομέα.
- Lussier, M. T. & Richard, C. (2005). Doctor-patient communication: Complaints and legal actions. *Canadian family physician Médecin de famille canadien*, 51: 37-39.
- Μαλτσάκη, Ε. Μ. (2014). *Επαγγελματική Συνεργασία Επαγγελματιών Υγείας*. [Πτυχιακή Εργασία]. Διδυμότειχο: Ανώτατο Τεχνολογικό ίδρυμα Ανατολικής Μακεδονίας και Θράκης.
- Μανιαδάκης, Ν. (2005). Τα οικονομικά της Υγείας από την οπτική του μανάτζερ. Στο Ε. Γραμματικοπούλου (επιμ.), *Κοινωνία και υγεία IV*. Αθήνα: Εθνικό Ίδρυμα Ερευνών, Novartis, 89.

- Μπελλάλη, Θ. (2018). Η επικοινωνία με τον ασθενή, στις μέρες μας: Αναγκαία ή περιττή κλινική δεξιότητα/πράξη;. *Ελληνικό περιοδικό της Νοσηλευτικής Επιστήμης*, 11: 3-8.
- Μπιτσώρη, Ζ. (2013). Ο ρόλος της επικοινωνίας στον χώρο της υγείας. *Περιεχειρητική Νοσηλευτική*, 2: 66-71.
- Μποστανίτης, Ι. & Τσαλίδου, Μ. (2010). Προσδιοριστικοί παράγοντες της ικανοποίησης ασθενών: Οι σχέσεις ιατρών-ασθενών. *Επιθεώρηση Υγείας*, 21: 15-19.
- Ναούμ, Σ. (2018). Επικοινωνία γιατρού-ασθενούς: Οφέλη, προβλήματα και στρατηγικές βελτίωσης. *Επιστημονικά Χρονικά*, 23: 265-275.
- National Center for Health Statistics. (2012). *Healthy People 2010 Final Review*. MD: Hyattsville.
- Παναγοπούλου, Ε. & Μπένος, Α. (2004). Η επικοινωνία στην ιατρική εκπαίδευση. Ζήτημα ανάγκης ή άκαιρη πολυτέλεια;. *Αρχαία Ελληνικής Ιατρικής*, 21: 385-390.
- Paternotte, E., Dulmen, S.V., Bank, L., Seeleman, C., Scherpbier, A. & Scheel, F. (2017). Intercultural communication through the eyes of patients: experiences and preferences. *International Journal of Medical Education*, 8: 170-175.
- Philips, D. (1996). Medical professional dominance and client dissatisfactions. *Social Science and Medicine*, 42: 1419-1425.
- Rajiv, N. R. & Lapinski, M. K. (2009). Why health communication is important in public health. *Bulletin of the World Health Organization*, 4: 247-247.
- Ροβίθης, Μ. Ν. (2016). *Μέτρηση της οργανωσιακής κουλτούρας των ιατρών, νοσηλευτών και λοιπών επαγγελματιών υγείας; σε κέντρα υγείας και νοσοκομεία της Κρήτης* [Διδακτορική διατριβή]. Ηράκλειο: Πανεπιστήμιο Κρήτης.
- Robinson, T.N., Patrick, K., Eng, T. R. & Gustafson, D. (1998). An evidence-based approach to interactive health communication: a challenge to medicine in the information age. *Science Panel on Interactive Communication and Health*, 14: 1264-1269.
- Roter, D., Stewart, M., Putnam, S. M. & Lipkin, M. C. (1997). Communication Patterns of Primary Care Physicians. *The Journal of the American Medical Association*, 277: 350-6.
- Ρουμελιωτάκη, Θ. & Χρονάκη, Α.Ε. (2009). Χρήση του διαδικτύου για θέματα υγείας Θέσεις και απόψεις Ελλήνων 15-35 ετών. *Αρχαία Ελληνικής Ιατρικής*, 2: 246-256
- Σαλμάν, Α. & Πλατσίδου, Μ. (2002). Η επαγγελματική εξουθένωση και επαγγελματική ικανοποίηση των δικηγόρων Θεσσαλονίκης. *Το Βήμα των Κοινωνικών Επιστημών*, 1Ε (60).
- Schillinger D., Piette J., Grumbach K., Wang F., Wilson C., Daher C. & Bindman A. B. (2003). Closing the loop: Physician communication with diabetic patients who have low health literacy. *Archives of Internal Medicine*, 1: 83-90.
- Schmidt, I. K. & Svarstad, B. L. (2002) Nurse-physician communication and quality of drug use in Swedish nursing homes. *Social science & medicine*, 12: 1767-77.
- Σταθοπούλου, Χ. (2006). Επίλυση συγκρούσεων σε νοσοκομειακό περιβάλλον. *Νοσηλευτική*, 1: 50-58.
- Steinberg, L. (2007). Risk Taking in Adolescence: New Perspectives from Brain and Behavioral Science. *Sage Journals*, 16: 142-150.
- Τσαντήλα, Α. (2010). *Επαγγελματική εξουθένωση των επαγγελματιών υγείας που εργάζονται σε ογκολογικά νοσοκομεία του Νομού Αττικής* [Πτυχιακή Εργασία]. Ηράκλειο: Ανώτατο Τεχνολογικό Εκπαιδευτικό Ίδρυμα Κρήτης.
- Τσουνής, Α. & Σαράφης, Π. (2014). Η επικοινωνία ιατρού-ασθενούς ως παράμετρος καθορισμού της παρεχόμενης φροντίδας υγείας. *Αρχαία Ελληνικής Ιατρικής*, 31: 534-540.
- Watson, T. J. (2005). *Κοινωνιολογία, εργασία και βιομηχανία*. Αθήνα: Εκδόσεις Αλεξάνδρεια.
- Χάρος, Δ., Κολυπέρα, Β., Λαζαρίδου, Ε., Ανδριοπούλου, Μ., Βιβιλάκη, Β. & Λιβάνης, Ε. (2017). Ο αντίκτυπος του εργασιακού άγχους στους επαγγελματίες υγείας κατά τη διάρκεια της οικονομικής κρίσης. *Αρχαία Ελληνικής Ιατρικής*, 34: 467-475.



**TOPIC 13: GOVERNANCE AND POLITICS IN GREECE**

### 13.1. Organizational size and IT innovation adoption: A scrutiny of the relationship between size and e-Government maturity in Greek municipalities, through a citizen/service-oriented maturity model.

*Michail Tsafantakis*<sup>179</sup>

#### **Abstract**

This study shed light on the relationship between organizational size and e-Government maturity, through the scrutiny of Greek local governments' effort to deliver public value via IT innovation. Having taken into consideration the urgent need for e-Government maturity models which demonstrate an explicit focus, the stage model themes Lee (2010) identified, and the remark by Andersen and Henriksen (2006) about the major importance of the customer perspective in e-Government strategic thinking, we proposed an innovative maturity model with an explicit focus on the citizen/service theme. The proposed maturity model consists of 7 developmental phases (Web presence, Two-way communication, Service & financial transaction, Participation, Personalization, Collaboration, e-Governance). Through the aforementioned model, this study initially identified the e-Government maturity of all the Greek municipalities and subsequently, scrutinized its relationship with organizational size. Our findings revealed that higher number of permanent municipal employees is associated to higher possibility for the phases of Service & financial transaction, Participation, Personalization and Collaboration to be materialized. Furthermore, we concluded that an increase of 1 permanent municipal employee would increase the odds of materialization of Two-way communication, Service & financial transaction, Participation and Collaboration by 7.7%, 28%, 2.6% and 1.2% respectively.

**Keywords:** e-Government, organizational size, municipalities, IT innovation

#### **Introduction**

Over the past decades a technological outburst has greatly impacted people's everyday life (Dunleavy et al., 2006; Moon, 2002; West, 2004). The internet has become an integral part of our daily routine, and the use of information communication technology (ICT) has risen prominently (Arduini & Zanfei, 2014; West, 2004). This rapid development -World Wide Web initiated only in 1989- affected both the private and the public sector. As far as the public sector is concerned, the emergence of *digital or electronic government (e-Government)* was a natural development which stemmed from the numerous potentials ICT offers (Arduini & Zanfei, 2014; Moon, 2002; West, 2004).

A concise definition of *e-Government* is provided by Nam (2014), who proposed that it is —*the use by government of information and communication technologies (ICTs) to deliver information and services to citizens, businesses, and public agencies* (Nam, 2014: 211). E-Government is a continuous and evolutionary phenomenon, which demonstrates a dynamic nature, and therefore, it is treated accordingly both by academics and practitioners (Das et al., 2017; Layne & Lee, 2001; Veljković et al., 2014). In order to describe —the state of a given level in a continuous process, the concept of —maturity is often used (Andersen & Henriksen, 2006: 239).

---

<sup>179</sup> Leiden University, Faculty of Governance and Global Affairs, MSc. Public Administration, the Netherlands. Email: ts\_m@live.com

Based on the features that government websites demonstrate, the governmental online presence can be considered to have a certain degree of maturity, which operates as a depiction of the level up to which e-Government has evolved within a certain context. According to Das, Singh and Joseph, *e-Government maturity* can be defined as *the extent to which a government has established an online presence* (Das et al., 2017: 416). In order for the development or maturity of e-Government to be expressed, there are several maturity models which refer interchangeably to stages, phases or levels (Das et al., 2017; Layne & Lee, 2001; West, 2004).

However, the existing models are incongruent with each other (Lee, 2010: 220). The factor which inevitably leads to the aforementioned incongruence is the mixed foci of the vast majority of the existing models. More specifically, as Lee (2010) very successfully recognized in his qualitative meta-synthesis, two underlying themes characterize the development models; the *citizen/service* theme and the *operation/technology* one (Lee, 2010: 220). Based on this categorization, it could be postulated that the vast majority of maturity models demonstrate mixed foci not only to each other but even themselves, as their stages, phases or levels belong to different themes. This turbidity incommodes both scholars and practitioners, since they face difficulties both in the interpretation of research results and in planning future actions for e-Government (Lee, 2010).

Another topic of IT innovation adoption which has attracted significant attention is its relationship with organizational characteristics (Del Aguila-Obra & Padilla-Meléndez, 2006; Hameed et al., 2012; Li & Feeney, 2014; Moon, & Bretschneider, 2002; Walker, 2014). In particular, organizational size is an organizational feature which has been studied extensively as a determinant of IT innovation adoption (Camisón-Zornoza et al., 2004; Lee, & Xia, 2006; Yao et al., 2003). Nevertheless, despite the plethora of studies, the research on the relationship between organizational size and IT innovation adoption has generated contradictory findings (Camisón-Zornoza et al., 2004: 332; Lee, & Xia, 2006: 975). As Camisón-Zornoza et al. characteristically frame it in their meta-analysis: the most consistent result found in the organizational innovation literature is that its research results have been inconsistent (Camisón-Zornoza et al., 2004: 332).

Various factors contribute to this inconsistency. Lee and Xia distinguish the inconsistent operationalization of organizational size and the unsuccessful recognition of important contextual variables (Lee, & Xia, 2006: 975). De Vries, Bekkers and Tummers, in their literature review which included 181 articles and books, recognized a gap of major importance in the state of the art understanding of innovation processes across different cultural contexts (De Vries et al., 2016: 163). The majority of relevant studies concern the UK and USA, which limits our understanding and creates ardent urgency for studies on different contexts (De Vries et al., 2016). Moreover, De Vries et al. underlined the lack of cross-national studies, stressed the need for quantitative studies to be increased and suggested a wider range of research methods that would enhance our understanding (De Vries et al., 2016).

This study has been designed as a response to the previous literature gaps. It intends to shed light on the blurry relationship between organizational size and IT innovation adoption, through the scrutiny of a totally unexplored context on the research field of public sector innovation, namely the Greek municipalities. Greece was chosen because of its unique financial condition over the recent past. Greece suffered the longest recession of any advanced capitalist economy to date, during which a series of strict austerity measures were implemented (Oxenford & Chryssogelos, 2018). Hence, the investigation of its municipalities provides an exceptional opportunity to scrutinize e-Government development in organizations which have operated under critical fiscal circumstances over a long period of time.

However, perhaps the most important contribution of this study lies with the innovative framework which is suggested for the inference of e-Government's maturity. This framework is based on Lee's (2010) remark that two underlying themes characterize e-Government's maturity models; namely the citizen/service and the operation/technology one (Lee, 2010). More specifically, *based on the citizen/service theme*, we propose a *citizen/service-oriented e-Government maturity model*. In this way, the focus of our stage model is explicit, something which has important implications both for this study and the relevant literature.

Utilizing the aforementioned model, this study aims to provide an answer to the question:

—*What is the relationship between organizational size and e-Government maturity?*

In order for this to be accomplished, we will identify the e-Government maturity of the 325 Greek municipalities<sup>2</sup> through website content analyses and subsequently, the appropriate statistical analyses will be conducted for our research question to be addressed. The following section provides the theoretical basis of this study. Thereafter, its methodology is outlined. Then, our analyses are presented, followed by a discussion of our findings and their implications.

### **Theoretical framework**

Scholars have come up with a broad variety of maturity models that monitor the level up to which e-Government has been developed (Alhomod et al., 2012; Almazan & Gil-García, 2008; Andersen & Henriksen, 2006; Hiller & Bélanger, 2001; Howard, 2001; Kim & Grant, 2010; Layne & Lee, 2001; Lee & Kwak, 2012; Moon, 2002; Shahkooh et al., 2008; Siau & Long, 2005; West, 2004). However, an important implication about the existing models is the incongruence they demonstrate to each other (Fath-Allah et al., 2014; Lee, 2010). Taking into consideration the need for maturity models which demonstrate an explicit focus, the themes Lee (2010) identified, and the remark by Andersen and Henriksen (2006) about the major importance of the customer perspective in e-Government strategic thinking, this study proposes a *maturity model with an explicit focus on the citizen/service theme*.

---

<sup>2</sup> The number of Greek municipalities recently changed to 332. However, this study had already been completed.

### The proposed maturity model

The proposed citizen/service-oriented model is composed of 7 maturity stages (**Figure 1**). These stages are: i) **Web presence** (*One-way communication*), ii) **Two-way communication**, iii) **Service & financial transaction**, iv) **Personalization** (*Individual consideration*), v) **Participation**, vi) **Collaboration**, vii) **e-Governance**. Subsequently, these stages are outlined:

—**Web presence** refers to the existence of a website through which information are communicated to the public. The term —presence implies the —static nature of this stage, which is regarded as a state of inertia, since it involves no action apart from information dissemination. The alternative term “*One-way communication*” signifies the flow of information, which can be paralleled to a one-way road; from the organization to the public. It corresponds to the stage of publishing/cataloguing/presence that existing maturity models entail (Lee, 2010: 225).

The second stage, “**Two-way communication**”, concerns an interactive state between the government and the public, in which they both operate either as transmitter or as receiver of information. This stage has been named after the fact that information may flow to both directions. In other maturity models, someone may come across this stage named as —interaction (Lee, 2010: 225).

“**Service & financial transaction**” refers to the allowance of online services and financial transactions. During this stage, —web-based self-services replace civil servants in the duties they previously performed (Moon, 2002). The chosen term was consciously preferred over —transaction and —portal, which other stage models use for corresponding stages. —Transaction was avoided because, subconsciously, people primarily think of financial transactions. Furthermore, the metaphor of —portal was avoided because, as Lee (2010) notes, it may connote the integration of operations (Lee, 2010: 225). This corresponds to the operation/technology theme, which contradicts the citizen/service-oriented character of our model.

The next stage of our model, “**Personalization**”, concerns e-Government’s adjustment to the personal needs, abilities or preferences of the user. The explanatory term “*Individual consideration*” connotes that this stage, practically, turns the public from —users into —individuals. Considering the citizen-oriented character of our model, this stage is regarded as of fundamental importance. Surprisingly, despite the large number of maturity models which were reviewed, only the one by Deloitte and Touche (2000) included a stage of —portal personalization (Deloitte & Touche, 2000, cited in Fath-Allah et al., 2014: 75). However, this is a narrower concept in comparison to ours. To make it more comprehensible, Nam (2014) identified 5 types of e-Government’s use; service use, general info use, policy research, participation and co-production (Nam, 2014). The —portal personalization refers to the first two types of e-Government use, whereas our suggestion concerns all of them.

“**Participation**” refers to citizenry participation in web-based political and problem solving activities. More specifically, it concerns the utilization of public input for the enhancement of policy decisions and government services (Veljković et al., 2014). During this stage, the government maintains full decision-

making powers. A corresponding stage can be spotted in Hiller and Belanger (2001) and in other maturity models as —Political participation‖ or —Open participation‖ (Almazan & Gil- Garcia, 2008; Hiller & Belanger, 2001; Lee & Kwak, 2012; Moon, 2002).

The following stage, “**Collaboration**”, refers to cooperation between the government and the citizenry. In contrast to —participation‖, —collaboration‖ is aimed at more responsive decision-making based on the public input, as active involvement in government operations is enabled (Veljković et al., 2014). Moreover, it entails significant, if not equal, power sharing (partnering) (Linders & Wilson, 2011: 268). Apart from the political cooperation, the public may also participate as co-producer of public services -e.g. —Government as platform‖ (Linders, 2012). Despite the fact that some maturity models imply or include the notion of collaboration, the maturity model by Lee and Kwak (2012) was the only among those reviewed, to devote a stage to —open collaboration‖ (Lee & Kwak, 2012).

“**E-Governance**” is the final stage of our model. It refers to the realization of all the abilities e-Government may provide. At this point, the power sharing is clearly in favor of the public through web-based direct Democracy, and the government merely demonstrates a facilitative character -e.g. —Do it Yourself or Citizen to Citizen Government‖ (Linders, 2012). Consequently, the public is in charge of the decision-making process and is also actively involved in service provision, either through self- service or through forms of co-production, in which it is in charge of. The maturity models which were reviewed had remained chary toward e-Government’s final stage, by depicting what seemed feasible according to the present situation, instead of e- Government’s endpoint. For instance, West (2004) proposed —interactive democracy‖, Shahkooh, Saghafi and Abdollahi (2008) suggested —digital democracy‖ and Siau and Long (2005) proposed —e-democracy‖. However, they refer to personalization, online voting, public forums and opinion surveys, leaving little space for participation and citizen engagement (Shahkooh et al., 2008; Siau & Long, 2005; West, 2004).

**Figure 1. Proposed e-Government stage model (Initial)**

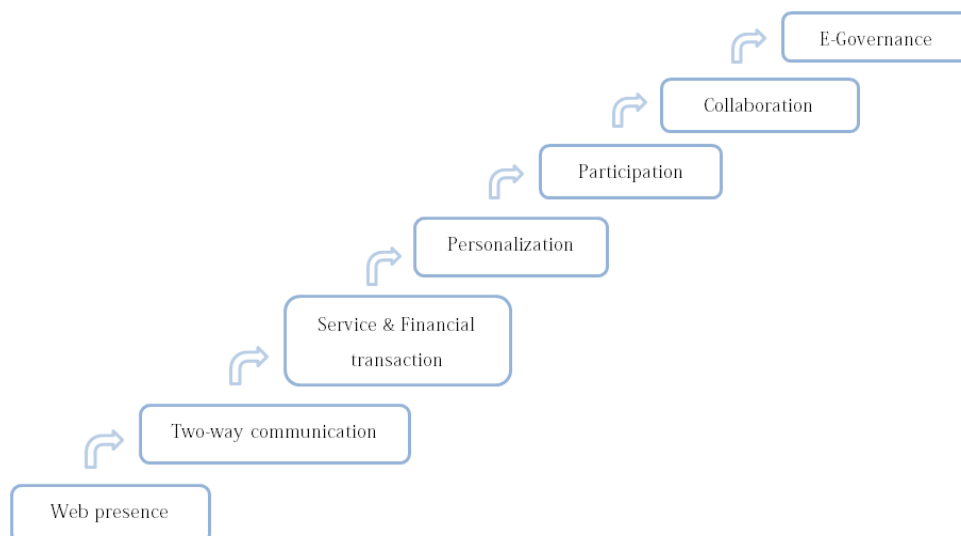

### Organizational size – innovation relationship

In general, organizational size has been found to demonstrate a positive effect on IT innovation adoption (Walker, 2014). Indeed, both the meta-analysis of Lee and Xia (2006) and the study by Yao, Liu, Xu and Lu (2003) confirmed this positive effect (Lee & Xia, 2006; Yao et al., 2003). Going one step further, according to Camisón-Zornoza et al. (2004) several studies argue that —organizational size is the best predictor of innovation (Aiken & Hage, 1971; Damanpour, 1992; Dewar & Dutton, 1986; Ettlie et al., 1983; Kimberly & Evanisko, 1981; Moch & Morse, 1977; Sullivan & Kang, 1999, cited in Camisón-Zornoza et al., 2004: 332).

In order for this positive relationship to be explained, quite a few arguments have been used. For instance, larger organizations possess more complex and diversified resources and capacities (Nord & Tucker, 1987, cited in Camisón-Zornoza et al., 2004: 339). Moreover, they have the ability to take on greater risks (Damanpour, 1992; Hitt et al., 1990, cited in Camisón-Zornoza et al., 2004: 339). This provides them both with the necessary —safe space and the ability to benefit from learning through failures. Furthermore, both communication and collaboration constitute platforms through which a variety of actors who possess different innovation assets can contribute to the innovation process (Bommert, 2010; Damanpour, 1991, cited in Hartley et al., 2013: 825). As a result, higher number of actors who interact would suggest better odds for innovation to take place.

Consequently, in line with the previous arguments, the first hypothesis of this study will be:

*H<sub>1</sub>: —The larger the size of a municipality is, the higher the degree of e-Government maturity it will demonstrate.*

On the other hand, someone may also come across scholars who suggest that the aforementioned relationship is a negative one (Aldrich & Auster, 1986; Hage, 1980; Wade, 1996, cited in Camisón-Zornoza et al., 2004: 332). They also provide a series of convincing arguments. Smaller organizations demonstrate higher degree of flexibility and adaptability (Lee & Xia, 2006: 976). For instance, the fewer the people who are involved, the fewer the potential objections at a debate about an innovative idea, and the easier it is to reach a decision, since the potential concessions are minimized. Hence, the smaller the organizational size, the faster the organization will adapt to new circumstances at its environment; which facilitates innovation. In addition, communication is considered to be more effective within smaller organizations. The fewer the times a message is transmitted, the more likely it is for the last receiver to receive it intact. As a result, members of smaller organizations are able to collaborate and be coordinated in a more efficient way, which accommodates innovation (Lee & Xia, 2006). Lastly, the inferior degree of formalization, which smaller organizations exhibit, may promote innovation (Lee & Xia, 2006). Formalization aims to ensure that organizational members act in a particular pre-determined way. Consequently, its absence may be beneficial for innovation.

As a result of these, an alternative hypothesis will be:

*H<sub>2</sub>: —The smaller the size of a municipality is, the higher the degree of e-Government maturity it will demonstrate.*

### **Methodology Research design**

This research demonstrates an observational and quantitative character. Specifically, a large-N design was chosen to test our hypotheses. We reached this decision due to its suitability for uncovering general relationships between variables, its effectiveness in providing answers to prospective causal questions and the supremacy of large-N research over comparative and single-case designs, in terms of identifying and estimating weak and heterogeneous causal relationships (Toshkov, 2016). Moreover, we aim to test assumptions that are based on existing theories, and large-N is deemed to be considerably good on this (Toshkov, 2016: 255). Finally, the particular research design will promote the state of the art in the research field of public sector innovation, due to the urgency for quantitative studies and theory testing (De Vries et al., 2016).

### **Case selection**

The Greek municipalities were chosen to serve as units of analysis due to several factors. Greece consists of 325 municipalities; a number which enables large-N research. Furthermore, this number is small enough to enable the scrutiny of their whole population, which would minimize randomness. In addition, their characteristics facilitate this study. Their homogeneity (identical sector, hierarchical level, mission, tasks) is valuable, since it enables the consideration of the whole population as target population. On the other hand, their heterogeneity in terms of size and e-Government maturity allows the necessary variability of our variables, which constitutes this study meaningful.

### **Data collection methods**

The data concerning our independent variable (organizational size), alongside with the data for most of our control variables (resource constraint, participation in political procedures, political support for decision-makers, size of IT department) will be acquired from the Hellenic Ministry of Interior (2019). The data concerning our last control variable (municipal population) will be acquired from the Hellenic Statistical Authority (2019). The aforementioned official authorities constitute the most reliable and transparent sources through which this type of data can be acquired.

In order to collect the data for the dependent variable (e-Government maturity), we will conduct a website content analysis for every Greek municipality. Firstly, the maturity stages of our model will be operationalized and indicators corresponding to their conceptualizations will be established. Afterwards,



the official websites<sup>3</sup> of the municipalities, catalogued by the Greek Ministry of Interior, will be inspected. Lastly, the municipal e-Government maturity (existence/non-existence of maturity stages) will be decided based on the established indicators.

### **Operationalization of variables**

#### *E-Government maturity*

The stages of our model operate as dummy variables for e-Government maturity and demonstrate a dichotomous character (existence, 1/non-existence, 0). It is unfeasible to outline all the potential indicators for each stage, since the development of e-Government is solely limited by its practitioners' creativity; hence, they are endless. Instead, a group of representative indicators will be provided for every stage, based on its conceptualization.

**Web Presence:** *Website existence.*

**Two-way communication:** *Existence of e-mail system, communication form or data transfer technology.*

**Service & financial transaction:** *Provision of online services (e.g. certificates) and execution of online transactions (e.g. municipal taxes). In order for a service to be valid for our categorization, it has to be fully carried out online. For instance, downloading a form and subsequently submitting it in person is not an indication of this stage.*

**Personalization:** *Website's ability to adjust to users' personal needs, abilities or preferences. This might come up in a variety of forms like adjustment of the website according to its users' disabilities (e.g. letters' size) or creation of a personal profile where personalized data lead to differentiated outcomes, or even reconfiguration of the website (e.g. individualized menus).*

**Participation:** *Public consultation initiatives, surveys and forums. The indicators of this stage facilitate the collection of opinions, ideas and solutions, which aim to affect policy decisions or services. However, they are by no means restrictive to the decision-making.*

**Collaboration:** *E-petitions, online voting (polls) and co-production of online services. Indicative examples are free online courses from citizens to citizens and e-health services, where citizens provide data which may result in action on behalf of the municipality (e.g. emergency button). This stage is characterized by power sharing.*

**E-Governance:** *Online voting whose outcome is binding for decision-making (e.g. for public constructions or municipal loans). This requires a unique personalized citizen identity, which secures through verification the integrity of the voting process. What differentiates online voting between the last two stages is the*

---

<sup>3</sup> In case that the official municipal website contains links leading to other municipal websites in order for municipal services/functions/transactions to take place (e.g. payment of water bills), these services/functions/transactions will also be taken into consideration.

notion of direct Democracy. In this stage, the power distribution is clearly in favor of the public. Moreover, *citizens are responsible for the service delivery* (e.g. control of co- production or self-service). Municipalities merely operate as facilitators or platforms which enable these actions to take place. Finally, another indicator of the e-Governance stage is the *continuous and unconstrained access to data* which may be useful for decision-making.

#### Organizational size

The type of size measure must be chosen wisely, since it may demonstrate a moderating impact on the size-IT innovation adoption relationship (Damanpour, 1992; Lee & Xia, 2006). In our case, size is regarded as an organizational factor, and thus, we will pick one from the respective measures, namely number of employees, size of assets, input and output volume or sales volume (Damanpour, 1992). Considering that input, output and transaction volumes fit mostly to the private sector, we ended up between the number of employees and the size of assets. The number of employees is better in terms of reliability and validity, as the calculation of assets in a public context can be complicated. In addition, municipalities provide data about their employees more often than they do for their assets. Finally, the operationalization of size as number of employees is of better fit to the proposed citizen/service-oriented maturity model, whereas size of assets would be more congruent to the operation/technology theme (Lee, 2010). Consequently, the number of full-time permanent office employees will be used as an indication of organizational size.

#### Control variables

In order for the validity of our study to be enhanced, we will control for variables which may affect IT innovation adoption. Firstly, the municipal population is an important criterion based on which the central Hellenic government allocates resources on a regular basis from the state budget to municipalities (Hellenic ministry of Interior, 2018). The potential impact that availability of financial resources might have on IT innovation has been outlined in various studies (Camisón-Zornoza et al., 2004; Damanpour, 1992; Hitt et. al., 1990). Consequently, we chose to regard “*population*” as a control variable. It will be considered as *the number of “legal” (registered) citizens of each municipality (De Jure population)*.

Based on the same reasoning, we will control for constraint resources as well. Financial resource poverty may lead to tight IT budgets, which could result in barriers to IT innovation adoption (Lee & Xia, 2006: 976). Resource constraint will be depicted by two variables; namely, loans and liabilities. As *loans* will be considered *the municipal loans (in €) acquired from credit institutions and organizations*, and as *liabilities* will be considered *the sum of municipal liabilities (in €) other than loans*.

Citizens who are committed to political processes may demonstrate greater interest in participation due to e-Government, which in turn could result in pressure to decision-makers for its further development. Thus, citizenry participation could operate as a catalyst for IT innovation adoption and we should consider it as a control variable. *The voter turnout in the Greek municipal elections of 2014* was chosen to operate

as the indicator of *participation in political procedures*.

Innovation adoption by definition requires alteration of the status quo. As it can easily be deduced, it is easier for governments who retain a higher degree of political support to innovate. Therefore, political support in favor of decision-makers is another variable which seems reasonable to control for. *The percentage of the winning party in the Greek municipal elections of 2014* will be used as an indicator of *political support*.

Finally, the IT department could be associated both with the organizational size and with the availability of IT-specific resources. In fact, Hameed et al. (2012) consider the IT department size of equal significance to organizational size as determinant of IT innovation adoption (Hameed et al., 2012). Therefore, its presence in our analysis is considered useful. *The number of full-time permanent IT office employees* will be used as an indication of *the municipal IT department size*.

### **Analysis strategy**

The statistical technique through which the relationship among our variables will be scrutinized is the regression analysis. In order to acquire a more reliable and valid impression, we chose to conduct a separate regression analysis for each of the 7 maturity stages. The alternative would be to consider e-Government as an interval variable. However, this would have weakened our analysis significantly, since e-Government's development is not linear (**Table 1**). Consequently, if we would attribute a particular value to it, this value would not be either reliable or valid.

Due to our choice, we will have to synthesize our final results in order to acquire a general impression regarding the relationship between organizational size and e-Government maturity. Consequently, organizational size may demonstrate differentiated relationships with the various stages. This is considered as an advantage of our choice, because otherwise we would be unable to acquire potentially differentiated, individualized information about each stage. The downside is that we might not formulate a straightforward answer to our research question, if the results for the various stages are contradictory. On the other hand, in case that the results are in congruence with each other, there will be an unambiguous answer to our research question.

### **Analyses and results**

This chapter will present and elaborate on the results which have been generated from our analyses, which took place in SPSS 20. Initially, the frequencies of the e-Government phases will be provided. Subsequently, a correlation matrix demonstrating the bivariate correlations between our variables will be presented. Finally, our hypotheses will be tested through binary logistic regression analyses.

**Note:** From now on, instead of the term stages, we will be using the term phases in order to refer to e-Government maturity. As it can be discerned at **Table 1**, the development of e-Government is not always linear. Hence, the term phases is more suitable than stages, which denotes a successive manner of development.

### Frequencies of e-Government phases

Once the 325 website content analyses were completed, we had acquired a detailed depiction of all the Greek municipalities' e-Government maturity (Table 1).

**Table 1: Depiction of e-Government maturity**

	A	B	C	D	E	F	G	H
	Municipality	Web presence	Two-way communication	Service & financial transaction	Personalization	Participation	Collaboration	e-Governance
1								
2	Abdera	1	1	1	1	1	0	0
3	Acharnes	1	1	1	1	1	1	0
4	Aegina	1	1	1	0	0	0	0
5	Agathonisi	1	1	0	1	0	0	0
6	Agia	1	1	1	0	1	1	0
7	Agia Paraskevi	1	1	0	1	1	1	0

and a document with elaborate argumentation concerning the phases that have been materialized (example).

#### Example of argumentation

- Acharnes - 3<sup>rd</sup>: Online transactions (e.g. payments of municipal taxes). Link for online acquirement of certificates through the website of KEP and consequently the national gate “Ermis”. 4<sup>th</sup>: Personal profile through which citizens can be informed about their municipal taxes. 5<sup>th</sup>: Ability to express complaints or demands online, and raise the interest of the municipality on them. 6<sup>th</sup>: Courses in pdf form, co-production with citizens/scientists (e.g. Unit of Environmental Science and Technology). Link for radiation measurement.

The following graph provides the frequency of occurrence for the e- Government maturity phases (Figure 2). In line with our proposal, the phase of —Web presence demonstrates the highest frequency of occurrence, followed by —Two-way communication.

**Figure 2: Frequency of occurrence**

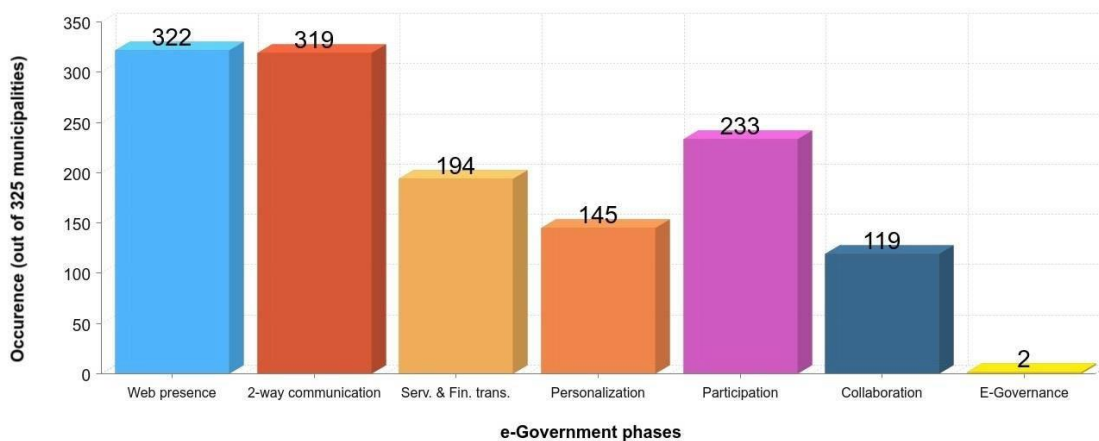

The subsequent findings could be characterized as surprising as Participation demonstrates higher frequency of occurrence (233) than both Service & Financial transaction (194) and Personalization (145). The qualitative characteristics of these findings could lead to reconsideration of the structure of the proposed model. Finally, the frequency of materialization of the last two e- Government phases is in line with our expectations. More specifically, Collaboration came up 119 times, whereas just 2 municipalities had developed e-Governance (Trikala and Ioannina)<sup>4</sup>.

### Bivariate correlations among the variables

The correlation matrix of Table 2 demonstrates the bivariate correlations between our variables. Its results will operate as preliminary answers to our hypotheses. Through the correlations, we will acquire an idea about whether there is a relationship between the e-Government phases and organizational size, and whether this relationship is a positive or a negative one. However, these results cannot be interpreted in isolation. The bivariate correlations among our independent and our control variables will contribute to the interpretation as well.

**Table 2. Bivariate correlation matrix**

Variables	1	2	3	4	5	6	7	8	9	10	11	12	13	14
1. Web Presence	1													
2. 2-way Com.	.704***	1												
3. Serv. & Fin.	.117*	.167***	1											
4. Personal.	.087	.123*	.271***	1										
5. Participation	.154**	.218***	.249***	.234***	1									
6. Collaboration	.073	.104	.169***	.179***	.364***	1								
7. E-Governance	.008	.011	.065	.088	.049	.104	1							
8. Perm. empl.	.048	.071	.193***	.106*	.197***	.223***	.092	1						
9. Perm. IT	.036	.054	.100	.082	.146***	.188***	.038	.891***	1					
10. Elect. turn.	.086	-.003	.111*	.016	.132*	.193***	.033	-.003	.013	1				
11. 1st party %	.048	.061	-.066	-.078	.002	.021	-.015	-.019	-.002	-.067	1			
12. Legal Pop.	.044	.069	.219***	.129*	.220***	.228***	.103	.948***	.806***	-.013	-.029	1		
13. Loans	.034	.040	.162***	.013	.077	.127*	.133*	.680***	.533***	.005	-.025	.654***	1	
14. Liabilities	.029	.033	.161***	.038	.086	.138*	.051	.580***	.462***	.044	-.017	.537***	.682***	1

\*= p < .055, \*\* = p < .05, \*\*\* = p < .01

Starting from the correlations between our independent variable and the 7 dummy variables (maturity phases), there are small positive statistically significant correlations between organizational size and the phases of “Service & Financial transaction”, “Participation” and “Collaboration”. Subsequently, the small positive correlation between organizational size and “Personalization” is statistically insignificant at the 0.05 significance level. However, in case that we do not settle on the primary result and we delve further into the particular correlation, we will notice that it is significant at the 0.055 significance level. Considering this is only a marginal difference, we accept the correlation as significant. A reasonable interpretation of the aforementioned results would be that: higher number of municipal employees is associated to higher possibility

<sup>4</sup> It should be noted that even at those municipalities “e-Governance” had been in a preliminary state, and a few other municipalities (Domokos, Edessa and Kavala) were close at achieving it as well.

for the phases of Service & financial transaction *Personalization, Participation and Collaboration to be materialized*. These results are in correspondence with our first hypothesis.

The statistically significant correlations between the control variables and the e-Government phases will be presented now. There are small positive correlations between: *IT department size* and Participation and Collaboration, *Elections Turnout* and Service & financial transaction, Participation and Collaboration, *Municipal Population* and Service & financial transaction, Personalization, Participation and Collaboration, *Municipal Loans* and Service & financial transaction, Collaboration and e-Governance and finally, *Municipal Liabilities* and Service & financial transaction and Collaboration. The previous correlations suggest that an increase at the aforementioned control variables is associated to higher possibility for materialization of the respective e-Government phases.

Subsequently, we come across the correlations between organizational size and some control variables, which may be an indication of multicollinearity, due to their magnitude. Multicollinearity exists in case of strong correlation between two predictor variables, something that makes it difficult to conclude which of them actually affects the outcome variable. In our occasion, strong positive correlations can be observed between organizational size and IT department size (.891), legal population (.948), loans (.680) and liabilities other than loans (.580). Consequently, we conducted a Variance Inflation Factor (VIF) test to check for multicollinearity existence (**Table 3**).

**Table 3. Collinearity Statistics**

Variables	VIF <sub>1</sub>	VIF <sub>2</sub>	VIF <sub>3</sub>
Permanent employees	20,792	7,010	1,954
Permanent IT employees	5,545	5,143	-
Elections turnout (%)	1,010	1,010	1,008
1st party (%)	1,007	1,006	1,005
Legal population	10,691	-	-
Loans (€)	2,498	2,496	2,424
Liabilities (€)	1,995	1,976	1,971

The most common cut off value of VIF is 5. The concerns which were generated due to the previous high correlations were proven reasonable. The results of VIF<sub>1</sub> indicate that the values of Permanent employees and Legal population are a lot higher than the threshold, which is an indication of multicollinearity. Consequently, appropriate action should be undertaken.

The most indicative actions are no-action, combination of the correlated variables or exclusion of the variable(s) responsible for the multicollinearity. Concerning Legal population, the no-action strategy does not constitute an option, since it would affect significantly our capability to measure the effect of organizational size on e-Government maturity. Moreover, the second strategy does not constitute a choice

either, due to the nature of the variables and to our intention to shape an opinion particularly about the effect of organizational size. In case the third strategy is followed, the values of the VIF test will drop, indicating the reduction of multicollinearity. However, this strategy may come at a cost; namely, omitted variable bias. Due to the reduction of our model's information, the depiction of the interaction between the variables might be less precise, in case that the omitted variable has an influence on the explanatory and the outcome ones. Nevertheless, this is a cost we have to undertake, due to the absence of a better alternative. Having removed the variable of —Legal population, we are led to VIF<sub>2</sub> at the second column of **Table 3**. As it can be noticed, there are once again prices higher than 5. However, this time our choice is easier. —Permanent IT employees already constitutes a part of —Permanent municipal employees and as a result, its exclusion does not lead to omitted variable bias. This is how we end up with VIF<sub>3</sub>, where there are no longer signs of multicollinearity.

### Binomial regression analyses

After taking care of multicollinearity, we have acquired our final set of variables. At this point, 7 binomial logistic regressions will be conducted, one for every maturity phase (**Table 4**). Through the binomial logistic regressions we aim to estimate the *probability that a municipality has developed each e-Government maturity phase based on the effect of organizational size* and the other independent variables. To conclude about our hypotheses, we will focus particularly on the effect of organizational size.

**Table 4. Binomial regression analyses**

Variables	B	Wald	Sig.	Exp(B)	Case Classification	Hosmer & Lemeshow test	Nagelkerke's R <sup>2</sup>	-2 log likelihood
<b>Web Presence</b>								
Permanent employees	.015	.141	.707	1.015	99.1%	.558 (Sig.= .990)	.384	21.412
Elections turnout	.069	1.945	.163	1.072				
First party	.208	.842	.359	1.231				
Loans	.000	1.009	.315	1.000				
Liabilities other than loans	.000	1.633	.201	1.000				
<b>2-way communication</b>								
Permanent employees	.075	3.893*	.048	1.077	98.2%	4.518 (Sig.= .808)	.216	47.794
Elections turnout	-.004	.014	.906	.996				
First party	-.158	1.176	.278	1.171				
Loans	.000	.000	.986	1.000				
Liabilities other than loans	.000	.420	.517	1.000				
<b>Service &amp; fin. transaction</b>								
Permanent employees	.247	22.651**	.000	1.280	70.2%	6.010 (Sig.= .646)	.183	390.911
Elections turnout	.017	1.865	.172	1.017				
First party	-.015	.855	.355	.985				
Loans	.000	.098	.754	1.000				
Liabilities other than loans	.000	.172	.678	1.000				
<b>Personalization</b>								
Permanent employees	.006	4.513*	.034	1.006	59.4%	17.123* (Sig.= .029)	.037	437.607
Elections turnout	.002	.027	.871	1.002				
First party	-.022	1.918	.166	.978				
Loans	.000	1.941	.164	1.000				
Liabilities other than loans	.000	.081	.776	1.000				
<b>Participation</b>								
Permanent employees	.026	25.864**	.000	1.026	73.2%	4.680 (Sig.= .791)	.194	340.207
Elections turnout	.024	3.391	.066	1.025				
First party	.006	.154	.694	1.006				
Loans	.000	10.281**	.001	1.000				
Liabilities other than loans	.000	.008	.927	1.000				
<b>Collaboration</b>								
Permanent employees	.011	14.800**	.000	1.012	68.6%	10.948 (Sig.= .205)	.150	389.218
Elections turnout	.049	11.478**	.001	1.050				
First party	.010	.417	.518	1.010				
Loans	.000	2.223	.136	1.000				
Liabilities other than loans	.000	.175	.675	1.000				
<b>E-Governance</b>								
Permanent employees	.006	.495	.482	1.006	99.4%	2.381 (Sig.= .967)	.125	21.415
Elections turnout	.096	.687	.407	1.100				
First party	-.033	.052	.820	.967				
Loans	.000	1.456	.228	1.000				
Liabilities other than loans	.000	.335	.563	1.000				

\* = p < .05, \*\* = p < .01

**Web Presence:** The relationship between Permanent employees and Web Presence is statistically insignificant (Sig.= .707).

**Two-way communication:** According to Hosmer and Lemeshow test, we have a good fitting logistic regression model, since the test was not statistically significant (Sig.= .808 > 0.05). The model explained 21.6% (Nagelkerke  $R^2$ ) of the variance in Two-way communication and correctly classified 98.2% of cases. Moreover, the relationship between Permanent employees and Two-way communication is statistically significant (Sig.= .048). As a result, organizational size is contributing to predicting the materialization of Two-way communication. Specifically, according to the Exp(B) column (odds ratios), an increase of organizational size in one unit (1 employee) would increase the odds of Two-way communication materialization by 1.077. This coefficient might seem small; however it is a notable one, considering that it concerns an increase of just 1 permanent employee. *This is in line with H<sub>1</sub>.*

**Service & financial transaction:** The linearity of the continuous variables with respect to the logit of the dependent variable was assessed via the Box-Tidwell (1962) procedure. A Bonferroni correction was applied, using all five terms in the model, resulting in statistical significance being accepted when  $p < .01$  ( $= \alpha/\text{number of independent variables} = .05/5 = .01$ ) (Tabachnick & Fidell, 2014). Based on this assessment, not all continuous independent variables were linearly related to the logit of the dependent variable (Permanent employees was not). Consequently, a transformation should be applied, in order for linearity to be achieved and the analysis to take place. Based on our data, the Natural log transformation was the appropriate to conduct (Laerd Statistics, 2015). Having applied the aforementioned transformation, linearity of the continuous variables with respect to the logit of the dependent variable was assessed again. This time, all continuous independent variables were found to be linearly related to the logit of the dependent variable.

The logistic regression model is a good fitting one (Sig.= .646 > 0.05). It explained 18.3% of the variance in Service & financial transaction and correctly classified 70.2% of cases. Moreover, the relationship between Permanent employees and —Service & financial transaction is statistically significant (Sig.=.000). As a result, organizational size is contributing to predicting the materialization of Service & financial transaction. More specifically, an increase of organizational size in one unit (1 employee) would increase the odds of materialization of Service & financial transaction by Exp(B)= 1.280, which is a remarkable coefficient. *This is in line with H<sub>1</sub>.*

**Personalization:** According to Hosmer & Lemeshow test, we have a poor fitting logistic regression model (Sig.= .029 < 0.05). The low amount of variance in —Personalization that the model is able to explain, corroborates that drawing further conclusions based on this particular model is of no additional utility (Nagelkerke  $R^2 = .037$ ).



**Participation:** The logistic regression model is a good fitting one (Sig.= .791 > 0.05). In addition, the model explained 19.4% of the variance in Participation and correctly classified 73.2% of cases. The relationship between Permanent employees and Participation is statistically significant (Sig.= .000). As a result, organizational size is contributing to predicting the materialization of Participation. Specifically, an increase of organizational size in one unit (1 employee) would increase the odds of materialization of Participation by  $\text{Exp}(B)= 1.026$ ; a small coefficient. *This is in line with H<sub>1</sub>.*

**Collaboration:** Like previously, we have a good fitting logistic regression model (Sig.= .205 > 0.05). It explained 15.0% of the variance in Collaboration and correctly classified 68.6% of cases. Out of the 5 predictor variables, 2 were statistically significant; —Elections turnout (Sig.= .001) and Permanent employees (Sig.= .000). Consequently, they are contributing to predicting the materialization of Collaboration. More specifically, increased elections turnout is associated with increased likelihood of Collaboration to be developed ( $\text{Exp}(B)= 1.050$ ). This finding is in agreement with our postulation in the theory that citizenry commitment to political processes may operate as a catalyst for IT innovation adoption.

Concerning organizational size, according to the  $\text{Exp}(B)$  column (odds ratios), its increase in one unit (1 employee) would increase the odds of materialization of Collaboration by 1.012, which is a small coefficient. *This is in line with H<sub>1</sub>.*

**E-Governance:** The relationship between Permanent employees and e- Governance is statistically insignificant (Sig.= .482).

## Discussion

### Theoretical implications

#### Organizational size – e-Government relationship

Our analyses depict a *positive relationship between organizational size and e- Government maturity*. Specifically, the bivariate correlations revealed that *higher number of permanent municipal employees is associated to higher possibility for the phases of “Service & financial transaction”, “Personalization”, “Participation” and “Collaboration” to be materialized*. It is noteworthy that there were indications of this positive relationship even for the remaining maturity phases (Web Presence, Two-way communication and e-Governance). However, these indications cannot be taken into consideration, due to the degradation this would suggest in terms of significance.

The positive relationship between organizational size and e-Government maturity was also depicted through the binomial regression analyses. In particular, we concluded that *an increase of 1 permanent municipal employee would increase the odds of materialization of “Two-way communication”, “Service & financial transaction”, “Participation” and “Collaboration” by 7.7%, 28%, 2.6% and 1.2% respectively*.

Considering that they refer to the increase of odds the increase by 1 employee would cause, these coefficients are remarkable; especially the one of Service & financial transaction. However, the magnitude of the particular coefficient must be treated with caution (details in the limitations).

Overall, based on our results we can safely reject H<sub>2</sub>, since at no point of this study a negative relationship between organizational size and the e-Government phases came up. On the other hand, our results support **H<sub>1</sub>**, stating that *the larger the size of a municipality is, the higher the degree of e-Government maturity it will demonstrate*.

These findings are in line with the majority of the studies in the respective research field that propose a positive relationship between organizational size and IT innovation adoption (Lee & Xia, 2006; Yao et al., 2003). Furthermore, they are in congruence with Walker (2014), stating that organizational size affects the adoption of process innovations in local governments in a positive manner (Walker, 2014: 31). Finally, if we broaden their spectrum, they are also in agreement with studies that revealed a positive relationship between organizational size and innovation (Camisón-Zornoza et al., 2004; Damanpour, 1992).

There are many plausible explanations about this positive relationship. Firstly, larger organizations often possess more complex and diversified resources and capacities (Lee & Xia, 2006; Nord & Tucker, 1987), and are able to take on greater risks (Damanpour, 1992; Hitt et al., 1990; Lee & Xia, 2006). Hence, they have the necessary safe space to think out of the box and also benefit from learning through failures. Theories concerning human interaction constitute also interesting explanations. Concepts like social innovation (Phills, Diegelmeier & Miller, 2008), co-creation (Prahalad & Ramaswamy, 2004), and open innovation (Chesbrough, 2003) refer to innovation generation through different types of interaction from a variety of actors (Hartley et al., 2013). In our case, the theories of collaborative innovation in the public sector are very relevant. For instance, network governance theories suggest that close collaboration in networks facilitates coming up with innovative solutions to problems which demonstrate a high degree of complexity (Hartley et al., 2013: 825). In general, there is growing evidence that collaboration is able to stimulate public innovation (Hartley et al., 2013: 825).

#### Proposed e-Government maturity model

One of the most important contributions of this study lies with the innovative e-Government maturity model it proposed. Its explicit focus on the citizen/service theme aims to enhance the overall understanding around maturity models, something which would facilitate the communication among scholars, reduce the fragmentation of the relevant literature and operate as a fundamental basis for further research.

However, some very interesting findings make us partially reconsider our initial suggestions, which reflected the most reasonable course of e-Government development, based on the relevant literature. More specifically, it became apparent that e-Government does not always follow a linear course of

development. Consequently, its maturity would be described more properly through the notion of phases. The particular term implies that there might be an overlap between the developmental levels, something which better depicts the reality in comparison to stages, which denotes a successive manner of development. Furthermore, our findings made us reconsider not only the character of the maturity levels but also their order of occurrence. Participation demonstrated higher frequency (233) than Service & Financial transaction (194) and Personalization (145). Concerning Service & Financial transaction, there were various cases of its existence which could not have been included, due to the chosen research design. For instance, some municipalities transact online, but they do not publicize it through their websites. Citizens may receive reference numbers alongside with their municipal taxes, and in this way perform online transactions. Nevertheless, this is a scenario outside the focus we chose to adopt. The reasoning behind our choice is that, in terms of e-Government, what is not on the web is considered as non-existent. Consequently, the 3<sup>rd</sup> phase our model will remain unchanged<sup>5</sup>.

However, this is not the case for the following two phases. Based on the qualitative characteristics of our findings, it became apparent that during the initiation of —Participation, citizens may participate without providing personal information. For instance, municipalities often asked for citizenry contribution, without requiring any personal details, as decision-makers often care about ideas or feedback and not about their providers' identity. This is undoubtedly a valuable finding of theoretical nature, which justifies adequately a reconfiguration of our maturity model. Consequently, *“Participation” and “Personalization” will become the 4<sup>th</sup> and the 5<sup>th</sup> phase of our model respectively (Figure 3).*

**Figure 3. Proposed e-Government phase model (Final).**

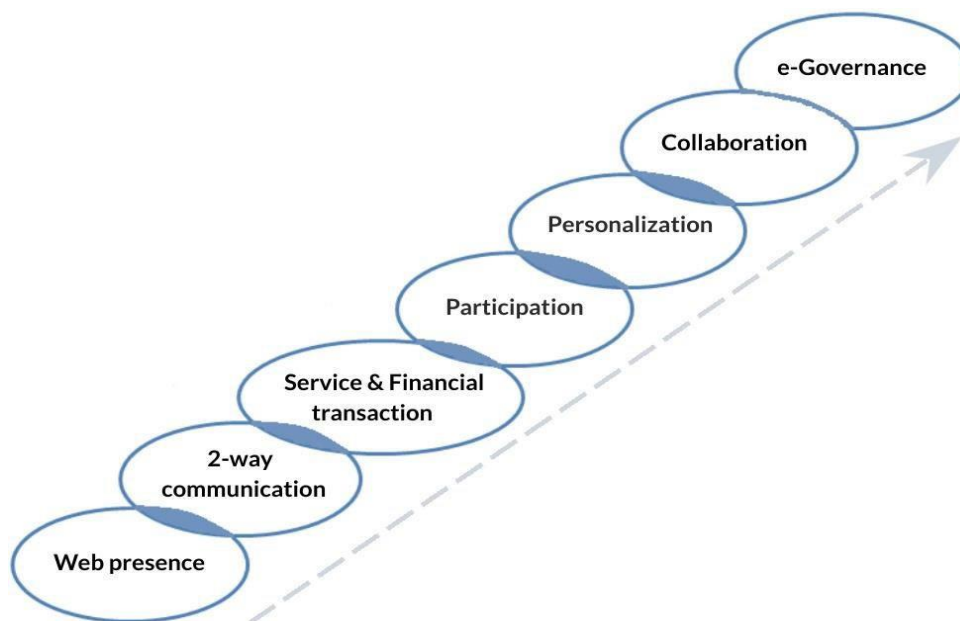

<sup>5</sup> Before we conclude, there was unofficial communication with a small number of municipalities, among which this proved to be common practice. Consequently, further research is needed.

Note: The blue areas could be characterized as creativity steps. They symbolize practitioners' ability to leapfrog maturity phases, as a result of their creativity. When policy-makers utilize a creativity step, they can transfer themselves in any phase possessing another creativity step. As it can be deduced from the graph, this does not apply to the e-Governance phase. E-Governance stands for the full realization of e-Government's potentials. As a result, practitioners must climb the whole e- Government maturity ladder in order to reach it.

### *Other implications*

The detailed depiction of e-Government development for all the 325 Greek municipalities was quite a challenge, due to the non-existence of relevant studies. Nevertheless, the value of exploring a previously unexplored context, with such exceptional characteristics of financial nature, compensated for this endeavor. This study shed light on the relationship between organizational size and e-Government maturity through the scrutiny of budget-strapped local governments' effort to deliver public value via IT innovation. It is noteworthy that the aforementioned relationship remains positive in such a context, which is in line with the relevant literature (Camisón-Zornoza et al., 2004; Damanpour, 1992; Lee & Xia, 2006; Walker, 2014; Yao et al., 2003). We expect this perspective to be proven valuable for the field of IT innovation.

### **Methodological implications**

Considering the urgency for quantitative studies and theory testing, our study may contribute towards a more comprehensive research body and promote the state of the art in the research field of public sector innovation (De Vries et al., 2016). Furthermore, the multi-method approach we deployed during the data collection is also in agreement with the abetment by De Vries et al. (2016) for wider range of research methods (De Vries et al., 2016).

### **Practical implications**

The proposed model and the operationalization of its phases have been constructed in a way that they constitute a framework which is easily applicable to various contexts. This aimed to facilitate cross-national studies and comparisons, which in turn may promote the deployment of cross-national policies (e.g. policy for digital convergence of the European municipalities).

In addition, there are important implications for public administration practitioners. Firstly, the positive relationship between organizational size and e-Government maturity could impact their choices. For instance, practitioners may modify the organizational size accordingly to create better potentials of e-Government upgrade for their organizations. Moreover, the conclusion that e-Government development takes place in the form of phases implies that practitioners could upgrade the maturity of their organizations through various phases simultaneously, instead of focusing their efforts on one phase at a time. In addition, the creativity steps facilitate practitioners understand that they can adjust the trajectory of e- Government's development to the needs of their organizations. Furthermore, the explicit focus on the

citizen/service theme of our model makes its comprehension much simpler. This will facilitate both the interpretation of the research and e- Government strategic planning.

Another important contribution lies with the depiction of Greek municipalities' e-Government maturity. It constitutes the only detailed overview of this kind, offering a thorough understanding to decision-makers (**Appendix**). Practically, municipalities may maximize their results through effective use of their resources, since they could achieve the desirable maturity upgrade by focusing at undeveloped phases. Furthermore, the central government could utilize the aforementioned detailed depiction to deploy data-driven policies aiming at digital convergence of the Greek municipalities, through e-Government enhancement.

### **Limitations**

In order to set the contribution of this study on a realistic basis, its limitations have to be outlined. This study cannot shed light neither on the causal mechanisms behind the scrutinized relationship nor on whether organizational size has a causal role on e-Government maturity. We can only express assumptions based on existing theories. A second limitation concerns the coefficient expressing the odds increase for the materialization of Service & Financial transaction due to an increase of 1 permanent municipal employee. In order for the binomial regression analysis to take place, we had to perform a transformation that may have had an impact on the magnitude of the aforementioned coefficient. Hence, the particular coefficient should be treated with caution. Another limitation is omitted variable bias. During the analysis, we had to remove legal population due to multicollinearity. Consequently, our model might be less precise, in case that the omitted variable has an influence on the explanatory and the outcome variables. A final limitation concerns this study's ability to depict e-Government maturity at a particular time point, which is in contrast to e-Government's continuous and evolutionary character (Das et al., 2017; Layne & Lee, 2001; Veljković et al., 2014).

### **Future research**

The aforementioned limitations logically lead to recommendations for further research. Valuable conclusions would arise from alterations of this study. For instance, a time series cross-sectional design (panel) would provide better blocking potentials (Toshkov, 2016). Moreover, multilevel (or hierarchical) large-N data provides more opportunities for blocking additional sources of confounding than the simple time series cross-sectional panel (Toshkov, 2016: 236). Consequently, valuable findings may come up if different administrative levels were scrutinized (e.g. the 13 Greek administrative regions). Finally, cross-national studies would also be valuable for the field of public sector innovation, as they would reveal to what extent our results are generalizable (De Vries et al., 2016).

Furthermore, some Greek municipalities which offered online transactions without advertising this option through their websites were not taken into consideration, since it opposed the focus of this study.

Nevertheless, it would be interesting for further research to investigate whether the omitted cases of Service & Financial transaction would have demonstrated a significant impact on our results.

Another recommendation stems from the citizen/service-oriented character of our maturity model. It would be considerably useful for future research to scrutinize the aforementioned relationship through a framework with an explicit focus on Lee's (2010) operation/technology theme, and investigate whether the positive relationship revealed by this study holds in that case as well.

The mechanisms behind the relationship of organizational size and e-Government maturity should also be investigated. Qualitative research is more powerful at exploring the underlying mechanisms e.g. through a single case study or a small combination of these (Toshkov, 2016). This would complement our results and enhance the understanding of the aforementioned relationship.

From a general point of view, we urge scholars to focus more on theory testing than on theory generation, due to the qualitative dominance in the field of public sector innovation (De Vries et al., 2016). Thus, we would end up with a better balance between qualitative and quantitative studies, which in turn would lead to a more comprehensive research body.

## Conclusions

This study aimed to shed light on the relationship between organizational size and IT innovation adoption. To this end, an innovative citizen/service-oriented e-Government maturity model was proposed, through which the e-Government maturity of the Greek municipalities was investigated and depicted for the first time. Finally, a positive relationship between organizational size and e-Government maturity was detected. Hopefully, this study will enhance the understanding of maturity models literature, facilitate e-Government strategic planning and serve as a basis for further research.

## References

- Aiken, M., & Hage, J. (1971). The organic organization and innovation. *Sociology*, 5(1): 63-82.
- Aldrich, H., & Auster, E. R. (1986). Even dwarfs started small: Liabilities of age and size and their strategic implications. *Research in organizational behavior*.
- Alhomod, S. M., Shafi, M. M., Kousarrizi, M. N., Seiti, F., Teshnehlab, M., Susanto, H., & Batawi, Y. A. (2012). Best practices in E government: A review of some Innovative models proposed in different countries. *International Journal of Electrical & Computer Sciences*, 12(1): 1-6.
- Almazan, R. S., & Gil-García, J. R. (2008). E-Government portals in Mexico. In *Electronic Government: Concepts, Methodologies, Tools, and Applications*. IGI Global, pp. 1726-1734.
- Andersen, K. V., & Henriksen, H. Z. (2006). E-government maturity models: Extension of the Layne and Lee model. *Government information quarterly*, 23(2): 236-248.
- Arduini, D., & Zanfei, A. (2014). An overview of scholarly research on public e- services? A meta-analysis of the literature. *Telecommunications Policy*, 38(5-6): 476-495.
- Bommert, B. (2010). Collaborative innovation in the public sector. *International public management review*, 11(1): 15-33.
- Box, G. E., & Tidwell, P. W. (1962). Transformation of the independent variables. *Technometrics*, 4(4): 531-550.

- Camisón-Zornoza, C., Lapiedra-Alcamí, R., Segarra-Ciprés, M., & Boronat-Navarro, M. (2004). A meta-analysis of innovation and organizational size. *Organization studies*, 25(3): 331-361.
- Chesbrough, H. W. (2003). *Open Innovation: The New Imperative for Creating and Profiting from Technology*. Boston: Harvard Business School Press.
- Damanpour, F. (1991). Organizational innovation: A meta-analysis of effects of determinants and moderators. *Academy of management journal*, 34(3): 555-590.
- Damanpour, F. (1992). Organizational size and innovation. *Organization studies*, 13(3): 375-402.
- Das, A., Singh, H., & Joseph, D. (2017). A longitudinal study of e-government maturity. *Information and Management*, 54(4): 415-426.
- De Vries, H., Bekkers, V., & Tummers, L. (2016). Innovation in the public sector: A systematic review and future research agenda. *Public administration*, 94(1): 146-166.
- Del Aguila-Obra, A. R., & Padilla-Meléndez, A. (2006). Organizational factors affecting Internet technology adoption. *Internet research*, 16(1): 94-110.
- Deloitte & Touche. (2000). *At the dawn of e-government: The citizen as customer*. New York: Deloitte Research. Available at: <http://www.egov.vic.gov.au/pdfs/e-government.pdf>
- Dewar, R. D., & Dutton, J. E. (1986). The adoption of radical and incremental innovations: An empirical analysis. *Management science*, 32(11): 1422-1433.
- Dunleavy, P., Margetts, H., Bastow, S., & Tinkler, J. (2006). New public management is dead—long live digital-era governance. *Journal of public administration research and theory*, 16(3): 467-494.
- Ettlie, J. E. (1983). Organizational policy and innovation among suppliers to the food processing sector. *Academy of Management journal*, 26(1): 27-44.
- Fath-Allah, A., Cheikhi, L., Al-Qutaish, R. E., & Idri, A. (2014). E-government maturity models: A comparative study. *International Journal of Software Engineering & Applications*, 5(3): 71.
- Hage, J. (1980). *Theories of organizations: Form, process, and transformation*. John Wiley & Sons.
- Hameed, M. A., Counsell, S., & Swift, S. (2012). A meta-analysis of relationships between organizational characteristics and IT innovation adoption in organizations. *Information & management*, 49(5): 218-232.
- Hartley, J., Sørensen, E., & Torfing, J. (2013). Collaborative innovation: A viable alternative to market competition and organizational entrepreneurship. *Public Administration Review*, 73(6): 821-830.
- Hellenic ministry of Interior. (2018). “Cleisthenes I” programme. Available at: <http://www.opengov.gr/types/?p=5963>.
- Hellenic ministry of Interior. (2019). *Human Resources Registry of the Hellenic Republic* (ref. number: 17576). Athens: Human Resources Administration of local governments.
- Hellenic Statistical Authority. (2019). *De Jure (registered) population 2011*. Available at: [http://www.statistics.gr/documents/20181/1210503/FEK\\_Nomimos\\_rev.pdf/9c385e3d-cd1c-4a9f-8caa-036bb1febe69](http://www.statistics.gr/documents/20181/1210503/FEK_Nomimos_rev.pdf/9c385e3d-cd1c-4a9f-8caa-036bb1febe69)
- Hiller, J. S., & Bélanger, F. (2001). Privacy strategies for electronic government. *E-government*, 200: 162-198.
- Hitt, M. A., Hoskisson, R. E., & Ireland, R. D. (1990). Mergers and acquisitions and managerial commitment to innovation in M-form firms. *Strategic Management Journal*: 29-47.
- Howard, M. (2001). E-government across the globe: how will e’change government. *e-Government*, 90, 80.
- Kim, D. Y., & Grant, G. (2010). E-government maturity model using the capability maturity model integration. *Journal of Systems and Information Technology*, 12(3): 230-244.
- Kimberly, J. R., & Evanisko, M. J. (1981). Organizational innovation: The influence of individual, organizational, and contextual factors on hospital adoption of technological and administrative innovations. *Academy of management journal*, 24(4): 689-713.
- Laerd Statistics (2015). Binomial logistic regression using SPSS Statistics. *Statistical tutorials and software guides*. Available at: <https://statistics.laerd.com/>
- Layne, K., & Lee, J. (2001). Developing fully functional E-government: A four stage model. *Government information quarterly*, 18(2): 122-136.
- Lee, G., & Kwak, Y. H. (2012). An open government maturity model for social media-based public engagement. *Government information quarterly*, 29(4): 492- 503.

- Lee, J. (2010). 10 year retrospect on stage models of e-Government: A qualitative meta-synthesis. *Government Information Quarterly*, 27(3): 220-230.
- Lee, G., & Xia, W. (2006). Organizational size and IT innovation adoption: A meta- analysis. *Information & Management*, 43(8): 975-985.
- Li, M. H., & Feeney, M. K. (2014). Adoption of electronic technologies in local US governments: Distinguishing between e-services and communication technologies. *The American Review of Public Administration*, 44(1): 75-91.
- Linders, D. (2012). From e-government to we-government: Defining a typology for citizen coproduction in the age of social media. *Government Information Quarterly*, 29(4): 446-454.
- Linders, D., & Wilson, S. C. (2011, June). What is open government?: one year after the directive. In *Proceedings of the 12th Annual International Digital Government Research Conference: Digital Government Innovation in Challenging Times*. ACM, pp. 262-271
- Moch, M. K., & Morse, E. V. (1977). Size, centralization and organizational adoption of innovations. *American sociological review*: 716-725.
- Moon, M. J. (2002). The evolution of e-government among municipalities: rhetoric or reality?. *Public administration review*, 62(4): 424-433.
- Moon, M. J., & Bretschneider, S. (2002). Does the perception of red tape constrain IT innovativeness in organizations? Unexpected results from a simultaneous equation model and implications. *Journal of Public Administration Research and Theory*, 12(2): 273-292.
- Nam, T. (2014). Determining the type of e-government use. *Government Information Quarterly*, 31(2): 211-220.
- Nord, W. R., & Tucker, S. (1987). *Implementing Routine and Radical Innovation*. Lexington, MA: Lexington Books.
- Oxenford, M., & Chryssogelos, A. (2018). Greek Bailout: IMF and Europeans Diverge on Lessons Learnt. Available at: [https://www.chathamhouse.org/expert/comment/greek-bailout-imf-and-europeans-diverge-lessonslearnt?fbclid=IwAR31RhbHqLkQbi2q41bNcNmBzu1KfYbn7QtLHp2A7YXt\\_qYX0-uASkCDh3Q](https://www.chathamhouse.org/expert/comment/greek-bailout-imf-and-europeans-diverge-lessonslearnt?fbclid=IwAR31RhbHqLkQbi2q41bNcNmBzu1KfYbn7QtLHp2A7YXt_qYX0-uASkCDh3Q)
- Phills, J. A., Deiglmeier, K., & Miller, D. T. (2008). Rediscovering social innovation. *Stanford Social Innovation Review*, 6(4): 34-43.
- Prahalad, C. K., & Ramaswamy, V. (2004). *The future of competition: Co-creating unique value with customers*. Boston: Harvard Business School Press.
- Shahkooh, K. A., Saghafi, F., & Abdollahi, A. (2008). A proposed model for e- Government maturity. In *Information and Communication Technologies: From Theory to Applications, 2008. ICTTA 2008. 3rd International Conference on*. IEEE, pp. 1-5.
- Siau, K., & Long, Y. (2005). Synthesizing e-government stage models—a meta- synthesis based on meta-ethnography approach. *Industrial Management & Data Systems*, 105(4): 443-458.
- Sullivan, P., & Kang, J. (1999). Quick response adoption in the apparel manufacturing industry: Competitive advantage of innovation. *Journal of Small Business Management*, 37(1): 1.
- Tabachnick, B. G., & Fidell, L. S. (2014). *Using multivariate statistics* (6th ed.), Essex, UK: Pearson.
- Toshkov, D. (2016). *Research design in political science*. New York: Palgrave Macmillan.
- Veljković, N., Bogdanović-Dinić, S., & Stoimenov, L. (2014). Benchmarking open government: An open data perspective. *Government Information Quarterly*, 31(2): 278-290.
- Wade, J. (1996). A community-level analysis of sources and rates of technological variation in the microprocessor market. *Academy of Management Journal*, 39(5): 1218-1244.
- Walker, R. M. (2014). Internal and External Antecedents of Process Innovation: A review and extension. *Public Management Review*, 16(1): 21-44.
- West, D. M. (2004). E-government and the transformation of service delivery and citizen attitudes. *Public administration review*, 64(1): 15-27.
- Yao, J. E., Xu, X., Liu, C., & Lu, J. (2003). Organizational size: a significant predictor of IT innovation adoption. *Journal of Computer Information Systems*, 43(2): 76-82.



## APPENDIX

Depiction of e-Government maturity (Greek municipalities)

Note: 1: Existence of e-Government phase, 0: Nonexistence of e-Government phase

	A	B	C	D	E	F	G	H	I	J	K	L	M	N	O
	Municipality	Web presence	Two-way communication	Service & financial transaction	Personalization	Participation	Collaboration	e-Governance	Elections turnout (%)	1st party (%)	Legal Population	Permanent employees	Permanent IT employees	Loans (€)	Liabilities (other than loans) (€)
1															
2	Abdera	1	1	1	1	1	0	0	54,48	60,97	23044	29	3	1175381	392873
3	Acharnes	1	1	1	1	1	1	0	63,66	54,05	74886	214	16	27712503	14934811
4	Aegina	1	1	1	0	0	0	0	64,38	50,34	12692	27	1	1688067	1899468
5	Agathonisi	1	1	0	1	0	0	0	71,63	58,21	316	2	0	0	0
6	Agia	1	1	1	0	1	1	0	62,87	53,14	14646	30	0	2092277	560562
7	Agia Paraskevi	1	1	0	1	1	1	0	69,05	50,82	40629	88	10	2974288	3566596
8	Agia Varvara	1	1	1	1	1	1	0	62,96	53,23	23188	46	3	6437133	1377254
9	Agioi Anargyroi-Kamatero	1	1	1	1	1	0	0	65,49	50,45	46642	108	4	8238666	1942232
10	Agios Dimitrios	1	1	1	0	1	1	0	67,2	57,29	49149	74	11	4453556	1504397
11	Agios Efstratios	1	1	0	0	0	0	0	26,85	58,7	616	3	0	0	73918
12	Agios Nikolaos	1	1	1	0	1	0	0	67,79	54	24636	64	1	3347028	1376230
13	Agios Vasileios	1	1	0	1	1	1	0	73,57	56,38	9488	19	0	218275	382669
14	Agistri	1	1	0	0	1	0	0	72,07	58,86	1116	2	0	0	324750
15	Agrafa	1	1	1	0	0	1	0	47,39	100	13529	17	0	0	738118
16	Agrinio	1	1	1	0	1	1	0	56,73	66,87	106056	168	8	10753132	2070260
17	Aigaleo	1	1	1	1	1	0	0	60,42	60,03	60504	171	33	9851294	3297967
18	Aigialeia	1	1	0	1	1	1	0	61,27	53,96	52954	100	2	6428969	2311128
19	Aktio-Vonitsa	1	1	1	1	1	1	0	62,34	52,01	20516	26	0	492420	436542
20	Alexandria	1	1	0	1	1	1	0	69,34	56,18	45417	57	1	3111789	1529519
21	Alexandroupoli	1	1	1	1	1	1	0	62,94	53,33	63920	121	1	9995201	3282672
22	Aliartos-Thespieae	1	1	1	0	1	1	0	67,31	78,74	11645	17	1	137279	1896941
23	Allimos	1	1	0	0	1	1	0	68,31	57,78	31602	70	5	9053190	1055933
24	Almopia	1	1	1	0	1	0	0	63,6	52,1	33042	55	1	1429365	1123713
25	Almyros	1	1	0	0	1	0	0	67,2	55,27	20616	41	1	1287472	179893
26	Alonnisos	1	1	0	1	0	0	0	69,26	56,32	1881	12	0	0	13920
27	Amari	1	1	0	0	0	0	0	73,39	52,77	6726	12	0	0	257750
28	Amfikleia-Elateia	1	1	1	1	1	0	0	66,54	54,14	11903	23	0	295682	355854
29	Amfilochia	1	1	1	1	0	0	0	49,92	50,78	25654	25	0	2136771	617398
30	Amfipoli	1	1	1	1	1	1	0	57,23	51,12	13800	24	0	11365	631435
31	Amorgos	1	1	0	0	0	1	0	61	51,3	2202	7	0	0	119684
32	Ampelokipi-Menemeni	1	1	1	1	1	0	0	62,99	53,18	40159	79	6	1762806	619979
33	Amyntaio	1	1	1	0	0	0	0	54,2	52,39	20051	45	0	976788	88266
34	Anafi	1	1	1	0	0	0	0	76,54	59,89	423	2	0	0	17710
35	Ancient Olympia	0	0	0	0	0	0	0	59,73	53,07	19534	24	1	12781	868746
36	Andravida-Killini	1	1	0	0	1	1	0	57,59	52,23	22079	36	1	309737	1471267
37	Andritsaina-Krestena	1	1	0	0	1	0	0	54,17	53,61	17976	31	1	633609	755203
38	Andros	1	1	0	1	1	0	0	52,29	59,89	11308	28	1	336278	737547
39	Anogeia	1	1	0	0	0	1	0	80,71	50,02	3105	7	1	0	213256
40	Antiparos	1	1	0	0	1	1	0	81,9	54,52	1280	2	0	0	105826

	A	B	C	D	E	F	G	H	I	J	K	L	M	N	O
41	Apokoronas	1	1	1	1	0	0	0	59,16	51,86	15290	36	1	771645	334164
42	Archanes-Asterousia	1	1	0	0	1	1	0	77,08	50,59	18652	31	1	1539784	1145705
43	Argithea	1	1	1	1	0	0	0	40,2	60,37	6707	5	0	1041846	355034
44	Argos Orestiko	1	1	0	1	1	0	0	59,18	63,35	12000	23	2	0	331796
45	Argos-Mykines	1	1	0	0	1	0	0	65,99	61,06	44458	85	3	1910874	704720
46	Aristoteli	1	1	1	0	0	0	0	74,88	51,13	21654	26	0	3584719	3679391
47	Arriana	1	1	0	1	0	0	0	61,84	54,96	18308	29	4	0	672758
48	Arta	1	1	0	0	1	0	0	63,81	57,21	48301	88	4	877821	1514885
49	Aspropyrgos	1	1	1	1	1	1	0	70,74	50,68	26717	183	5	22437515	495280
50	Astypalaia	1	1	0	0	0	0	0	70,37	54,65	1789	10	0	0	63208
51	Athens	1	1	1	0	1	1	0	52,17	51,42	467160	1157	79	98241241	34540763
52	Central Tzoumerka	1	1	1	1	0	0	0	48,25	52,47	12731	13	1	376699	446371
53	Chalandri	1	1	1	1	1	1	0	65,94	52,4	52606	152	26	5416905	1712010
54	Chalki	1	1	1	0	1	0	0	70,92	53,66	604	3	0	0	65343
55	Chalkida	1	1	1	1	1	1	0	65	51,28	86394	142	13	5477106	2398674
56	Chalkidona	1	1	0	0	1	0	0	70,25	51,46	34628	43	2	1789406	1436607
57	Chania	1	1	1	0	1	1	0	60,75	59,88	84527	187	16	3440079	2094691
58	Chios	1	1	1	1	1	1	0	48,24	60,65	51339	112	4	1005233	605666
59	Corfu	1	1	1	0	1	1	0	50,75	58,19	98754	210	2	19688108	19372830
60	Corinth	1	1	1	0	0	0	0	67,46	50,08	55480	117	10	837981	1841168
61	Dafni-Ymittos	1	1	1	0	1	1	0	55,28	50,68	27828	54	3	2272723	318913
62	Delfi	1	1	1	0	0	0	0	61,07	56,52	29633	81	3	4099093	4728491
63	Delta	1	1	1	1	0	0	0	67,42	54,9	40941	78	2	3088193	1442801
64	Deskati	1	1	1	0	1	0	0	60,04	53,03	7904	17	0	75906	682407
65	Didymoteicho	1	1	0	1	1	0	0	44,84	54,52	23308	44	3	1099952	270494
66	Dion-Olympos	1	1	0	0	1	0	0	64,71	52,34	27013	39	1	4551734	762409
67	Dionysos	1	1	1	1	1	1	0	76,2	51,94	28642	88	12	1721752	2236785
68	Dirfys-Messapia	1	1	0	1	0	0	0	71,58	56,73	20417	37	1	1431058	1353369
69	Distomo-Arachova-Antikyra	1	1	1	1	1	0	0	70,46	54,37	8101	20	0	268399	165179
70	Dodoni	1	1	1	0	1	0	0	51,66	51,68	16726	26	1	487810	381648
71	Domokos	1	1	1	1	1	1	0	69,38	50,73	15227	22	0	88970	2417599
72	Dorida	1	1	1	0	1	1	0	54,78	51,32	15330	32	2	497339	292204
73	Doxato	0	0	0	0	0	0	0	54,91	54,57	18426	24	0	29369	915323
74	Drama	1	1	1	1	1	0	0	58,03	50,82	54399	94	5	0	940142
75	Edessa	1	1	1	1	1	1	0	61,66	60,02	30158	62	1	1204825	1615343
76	Elafonisos	1	1	1	0	1	1	0	73,52	51,76	1169	4	0	0	14732
77	Elassona	1	1	1	1	1	0	0	61,07	51,06	40879	58	2	2080014	1175322
78	Elefsina	1	1	1	0	0	0	0	67,08	64,06	26207	88	6	1974911	502179
79	Elliniko-Argruopoli	1	1	1	0	1	1	0	69,9	53,5	39971	103	3	3891269	2382381
80	Emmanouil Pappa	1	1	1	1	1	1	0	53,7	50,42	18878	28	0	27411	353613
81	Eordaia	1	1	1	1	1	1	0	64	57,35	45713	78	5	108450	2397918
82	Epidavros	1	1	0	1	1	1	0	68,84	57,34	8664	15	0	0	553884

	A	B	C	D	E	F	G	H	I	J	K	L	M	N	O
83	Eretria	1	1	1	0	1	0	0	68,09	50,92	13423	23	1	704481	3167549
84	Ermionida	1	1	1	1	1	0	0	69,43	50,55	12446	20	0	260142	284845
85	Erymanthos	1	1	1	0	1	0	0	77,78	58,5	13594	20	2	818302	725612
86	East Mani	1	1	0	0	1	0	0	42,95	93,21	16756	36	0	76742	594558
87	Eurotas	1	1	0	1	0	0	0	52,06	55,36	17755	32	0	14541	390399
88	Farkadona	1	1	0	1	1	0	0	51,8	56,4	16238	19	2	324155	728751
89	Farsala	1	1	1	1	1	0	0	66,08	51,09	22139	37	1	129064	1450199
90	Festos	1	1	1	0	1	1	0	70,67	52,05	24520	41	1	3976738	626714
91	Filadelfeia-Chalkidona	1	1	1	1	1	1	0	64,2	52,74	34859	84	7	3251560	1826166
92	Filiates	1	1	0	1	1	0	0	50,19	50,98	11390	22	0	714305	1094914
93	Filothoi-Psychiko	1	1	1	1	1	1	0	64,37	60,72	25827	67	1	1469495	1073158
94	Florina	1	1	1	1	1	0	0	35,61	50,42	33748	59	0	213933	1282831
95	Folegandros	1	1	0	0	0	0	0	71,97	50,17	819	2	0	0	14456
96	Foumoi Korseon	1	1	0	0	0	0	0	60,82	56,6	1894	5	0	0	98556
97	Fyli	1	1	1	0	1	0	0	68,69	54,7	39587	215	10	59289970	8901284
98	Galatsi	1	1	1	1	1	0	0	71,2	56,84	41676	107	4	1929400	964461
99	Gavdos	1	1	0	0	0	0	0	74,33	51,82	180	0	0	0	113589
100	Georgios Karaiskakis	1	1	1	1	1	0	0	60,01	58,21	10434	15	0	0	134246
101	Glyfada	1	1	0	1	1	1	0	66,79	62,93	64424	118	10	346832	3145637
102	Gortyn	1	1	1	1	1	0	0	66,2	50,15	19148	32	0	4187609	3339184
103	Gortynia	1	1	1	0	0	0	0	39,57	55,48	20598	37	0	211086	1235480
104	Grevena	1	1	0	0	0	0	0	60,21	50,45	33392	85	11	250546	474000
105	Haidari	1	1	1	0	1	0	0	70,06	68,56	36541	91	4	4979534	1362264
106	Hersonisos	1	1	1	0	1	1	0	76,47	51,6	21135	72	6	105132	2022930
107	Iasmos	1	1	0	1	0	0	0	53,22	51,24	15562	25	0	345673	423943
108	Ierapetra	1	1	1	0	1	0	0	63	58,56	25013	59	4	4636218	1093798
109	Igoumenitsa	1	1	0	1	1	0	0	51,7	57,07	25979	75	2	1725892	2406580
110	Ikaria	1	1	1	0	0	0	0	55,35	50,84	10385	26	0	0	172355
111	Ilida	1	1	1	1	1	1	0	56,88	55,51	36442	55	3	1085194	4160304
112	Ilion	1	1	1	1	1	1	0	65,34	69,3	58919	115	6	1388046	704993
113	Ilioupolis	1	1	0	1	1	1	0	67,68	51,09	64211	99	8	1133888	1005422
114	Ioannina	1	1	1	1	1	1	1	66,97	57,39	83904	164	9	20362893	6333264
115	Ios	1	1	0	0	1	0	0	57,25	63,71	2050	7	0	0	254514
116	Iraklia	1	1	0	0	0	0	0	55,64	55,13	25931	38	3	4711316	677021
117	Iraklio (Athens)	1	1	1	0	1	0	0	70,73	51,9	36910	106	5	6742931	1745721
118	Iraklio (Crete)	1	1	1	1	1	1	0	67,49	59,24	146750	270	11	26722761	2804109
119	Istiaia-Aidipsos	1	0	0	0	0	0	0	61,89	55,65	24209	35	0	3824649	2662533
120	Ithaca	1	1	0	0	0	0	0	36,35	51,81	3602	13	0	121635	68082
121	Kaisariani	1	1	1	0	0	0	0	57,58	61,55	22112	66	5	3241199	661121
122	Kalamaria	1	1	1	0	1	1	0	65,07	61,84	58773	129	9	724167	8925531
123	Kalamata	1	1	1	1	1	1	0	56,99	54,05	66363	150	7	8097894	2691050
124	Kalavrita	1	1	0	1	1	0	0	60,15	52,99	17376	29	0	1740189	444097

	A	B	C	D	E	F	G	H	I	J	K	L	M	N	O
125	Kalitheia	1	1	0	0	1	0	0	57,64	60,92	74153	142	33	2138907	1162732
126	Kalymnos	1	1	1	1	1	0	0	44,57	51,59	18621	42	1	1371041	485040
127	Kantanos-Selino	1	1	1	1	1	0	0	57,48	54,68	7089	17	0	252517	201805
128	Karditsa	1	1	1	1	1	1	0	61,92	55,37	61935	118	4	19639817	8105148
129	Karpathos	1	1	0	0	0	0	0	49,81	53,68	6794	30	3	409943	1100797
130	Karpenisi	1	1	0	0	1	1	0	47,65	60,54	17261	51	2	1749476	364714
131	Karystos	1	1	1	0	0	0	0	62,11	51,39	14643	35	1	706509	2863617
132	Kasos	1	1	0	0	1	0	0	47,09	54	1485	1	0	0	223105
133	Kassandra	1	1	1	1	0	0	0	67,54	53,41	15457	56	0	4283735	3654597
134	Kastoria	1	1	1	1	1	1	0	53,93	60,33	34653	99	2	508995	1380211
135	Katerini	1	1	1	1	1	0	0	61,87	50,5	84280	134	4	10340758	9213997
136	Kato Neokopoi	1	1	0	0	0	0	0	55,79	50,87	10682	21	1	0	375054
137	Kavala	1	1	1	1	1	0	0	55,15	57,55	67455	135	4	1725679	1943528
138	Kea	1	1	0	0	1	0	0	62,77	51,6	2379	10	1	0	173115
139	Kefalonia	1	1	1	0	0	0	0	41,36	51,59	37767	89	1	7696720	2335162
140	Keratsini-Drapetsona	1	1	1	1	1	1	0	58,92	62,36	74790	178	14	8502678	2946106
141	Kifissia	1	1	1	1	1	1	0	67,86	51,57	55291	157	9	5699477	2009852
142	Kileler	1	1	1	1	1	0	0	72,85	55,03	26018	43	1	1851220	741816
143	Kilkis	1	1	0	1	1	0	0	55,56	50,77	64232	99	1	4086591	1450168
144	Kimi-Aliveri	1	1	1	0	0	1	0	67,12	51,88	34284	50	4	562380	2665150
145	Kimolos	1	1	0	0	1	1	0	57,36	58,02	1378	2	0	0	0
146	Kissamos	1	1	1	0	1	0	0	66,78	50,91	12572	18	0	559739	283067
147	Komotini	1	1	1	1	1	0	0	59,42	56,11	55813	99	4	1979636	1509273
148	Konitsa	1	1	1	0	1	1	0	40,49	58,84	10514	20	1	540637	1487121
149	Kordelio-Evosmos	1	1	1	1	1	0	0	64,44	57,15	62863	160	9	5877664	4533909
150	Koropi	1	1	0	0	1	0	0	69,97	75,92	19475	42	0	1986225	888371
151	Korydallos	1	1	1	1	1	1	0	63,32	58,72	51653	111	10	11619060	11941257
152	Kos	1	1	1	0	1	0	0	59,94	66,18	25280	97	2	693664	2495543
153	Kozani	1	1	1	0	1	0	0	63,2	57,38	69976	120	11	10003093	2142990
154	Kythira	1	1	1	0	1	0	0	36,71	57,26	4579	12	0	0	73349
155	Kythnos	1	1	0	0	0	0	0	59,73	51,86	2712	4	0	0	222053
156	Lagadas	1	1	0	0	1	0	0	68,06	53,03	57049	55	4	4227586	1780916
157	Lamia	1	1	1	1	1	1	0	66,34	53,35	71007	109	7	2323461	1460676
158	Larissa	1	1	1	1	1	1	0	64,89	54,47	129533	206	17	9772177	6962580
159	Lasithi Plateau	1	0	0	0	0	0	0	72,78	52,07	3498	4	0	0	804584
160	Lavreotiki	1	1	1	0	0	0	0	75,02	57,08	21600	50	2	2062023	2663648
161	Lefkada	1	1	1	1	1	0	0	50,15	54,05	25229	74	11	6902455	3460801
162	Lemnos	1	1	1	0	1	0	0	37,31	51,66	15766	43	1	474762	488617
163	Leros	1	1	0	1	1	0	0	55,49	51,18	7755	26	2	223441	461056
164	Lesbos	1	1	1	1	1	0	0	45	57,27	85412	169	4	1716667	3820385
165	Lipsi	1	1	0	0	0	0	0	43,49	100	783	5	0	0	145073
166	Livadeia	1	1	1	1	1	1	0	65,3	56,24	33432	82	2	4710254	835407

	A	B	C	D	E	F	G	H	I	J	K	L	M	N	O
167	Lokroi	1	1	0	0	0	1	0	67,37	53,58	20817	36	0	0	1286955
168	Loutraki-Perachora-Agioi	1	1	1	0	1	1	0	71,64	60,91	18349	52	7	422546	1853311
169	Lykovysi-Pefki	1	1	0	0	1	1	0	72,18	54,3	23392	50	3	8315405	755583
170	Makrakomi	1	1	1	1	1	0	0	60,1	51,2	19213	28	0	317578	586047
171	Malevizi	1	1	1	1	1	0	0	79,05	80,08	22373	58	4	3776727	1100571
172	Mandra-Eidyllia	1	1	0	0	0	0	0	69,79	51,88	17722	37	2	0	762052
173	Mantoudi-Limni-Agia Anna	1	1	1	1	1	0	0	61,24	57,35	14141	36	1	3510065	947799
174	Marathon	1	1	1	0	1	0	0	76,15	53,55	24438	77	5	3149710	9972166
175	Markopoulo Mesogaia	1	1	0	0	1	0	0	73,75	50,46	13134	59	3	1301737	4170177
176	Maroneia-Sapes	1	1	0	0	0	0	0	54,07	67,33	18873	26	1	359753	558412
177	Marousi	1	1	1	1	1	1	0	66,06	57,89	56071	209	11	66993890	61614502
178	Megalopolis	1	1	0	0	0	0	0	50,47	50,09	13981	34	1	1875319	616098
179	Meganisi	1	1	1	0	0	0	0	65,79	54,6	1567	4	0	0	54676
180	Megara	1	1	1	1	1	1	0	70,99	53,78	30822	72	2	2949694	3197153
181	Megisti	1	1	0	0	0	0	0	30,1	55,07	566	2	0	0	5456
182	Mesolonghi	1	1	0	0	0	0	0	59,28	51,14	40501	72	4	425834	1904696
183	Messini	1	1	1	1	0	0	0	51,28	50	33086	63	1	2177499	680057
184	Metamorfosi	1	1	1	1	1	1	0	70,41	55,1	21233	65	5	4640799	497546
185	Meteora	1	1	1	1	1	0	0	54,64	53,57	33079	72	12	5784796	1294531
186	Metsovo	1	1	0	0	0	0	0	59,39	52,83	9865	15	0	0	347951
187	Milos	1	1	0	0	1	0	0	56,65	56,19	5129	13	1	0	365740
188	Minoa Pediada	1	1	1	0	1	0	0	76,45	52,43	20988	43	2	552949	619711
189	Molos-Agios Konstantinos	1	1	1	1	1	1	0	66,61	58,42	13048	20	1	2714900	831165
190	Monemvasia	1	1	1	1	1	0	0	45,36	73,86	22241	48	1	42335	454981
191	Moschato-Tewros	1	1	1	0	1	0	0	55,87	57,68	32573	73	2	5552983	808747
192	Mouzaki	1	1	0	0	1	0	0	58,87	55,33	20415	22	1	461056	465385
193	Myki	1	1	0	0	0	0	0	65,22	58,05	20573	22	0	624639	310244
194	Mykonos	1	1	0	0	0	0	0	72,56	52,51	7866	28	2	0	1763766
195	Mylopotamos	1	1	0	0	1	0	0	70,06	92,18	15886	27	1	1358019	529001
196	Nafpaktos	1	1	1	0	1	0	0	52,85	59,78	31594	66	4	615988	1494915
197	Nafplio	1	1	1	1	1	0	0	70,69	52,13	29993	73	5	2122095	1660898
198	Naoussa	1	1	0	0	1	1	0	67,8	60,36	34211	49	1	1165069	1079510
199	Naxos-Lesser Cyclades	1	1	1	1	1	1	0	59,98	55,93	22271	58	3	340658	1520013
200	Nea Ionia	1	1	1	1	1	1	0	64,13	56,49	49352	95	4	2255305	811126
201	Nea Proponitida	1	1	0	0	0	0	0	67,77	50,23	33507	78	4	5290908	4396334
202	Nea Smyrni	1	1	1	1	1	1	0	62,9	56,49	53665	115	17	3267618	1599917
203	Nea Zichni	1	1	1	0	0	0	0	59,59	53,8	17259	27	1	123333	277849
204	Neapoli-Sykies	1	1	1	1	1	0	0	60,78	63,48	69182	95	5	193704	1025010
205	Nemea	1	1	1	0	1	0	0	67,27	52,37	7398	20	0	174716	194132
206	Nestorio	1	1	0	0	1	0	0	37,53	50,5	4829	12	0	0	76533
207	Nestos	1	1	0	0	1	0	0	62,03	54,85	24004	34	4	0	637143
208	Nikaia-Agios Ioannis Rentis	1	1	0	0	1	1	0	53,59	62,25	89515	265	12	37669999	3656709

	A	B	C	D	E	F	G	H	I	J	K	L	M	N	O
209	Nikolaos Skoufas	1	1	0	1	1	1	0	64,13	55,28	14955	26	1	92336	1481439
210	Nisyros	1	1	1	0	0	0	0	43,88	59,96	1210	8	0	0	349748
211	North Kynouria	1	1	1	0	1	0	0	58,7	52,87	12922	29	0	642847	346426
212	North Tzoumerka	1	1	0	1	0	0	0	57,9	87,7	11064	11	0	652804	450153
213	Oichalia	1	1	0	0	1	1	0	44,62	53,25	15592	35	0	1108387	730093
214	Oinousses	1	1	0	1	0	0	0	47,19	55,26	1109	3	0	0	51205
215	Oraiokastro	1	1	1	1	1	1	0	71,15	51,88	32412	65	4	1894683	930032
216	Orchomenos	1	1	1	0	0	0	0	64,64	53,48	13107	22	0	1288538	1299949
217	Orestiada	1	1	0	0	1	1	0	49,18	58,39	37654	69	3	2635539	807769
218	Oropos	1	1	1	1	0	1	0	76,31	55,07	27151	54	2	502158	3969162
219	Paggalo	1	1	1	1	1	0	0	62,7	50,17	33951	53	1	1842556	1802649
220	Paiania	1	1	0	1	1	0	0	74,71	56,77	19108	55	1	90370	1195923
221	Paionia	1	1	0	0	1	1	0	56,72	54,43	34676	47	1	4123751	842170
222	Palaio Falliro	1	1	1	0	1	1	0	59,9	65,84	48666	129	7	0	1100028
223	Palamas	1	1	1	0	0	0	0	65,42	52,83	19467	29	0	2186545	1952047
224	Pallini	1	1	1	0	1	1	0	73,9	63,66	33475	94	9	0	940929
225	Papagos-Cholargos	1	1	1	1	1	1	0	69,7	62,02	38474	88	3	5521017	1337083
226	Paranesti	1	1	0	0	1	1	0	52,47	54,96	6913	10	0	6799	187054
227	Parga	1	1	1	0	0	0	0	56,23	64,48	13995	25	0	53238	413734
228	Paros	1	1	0	0	0	1	0	61,24	64,9	15278	45	2	174910	304443
229	Patmos	1	1	0	0	1	0	0	66,04	60,25	3118	16	0	0	251984
230	Patra	1	1	1	0	1	0	0	64,17	63,53	177252	307	30	14460282	6457085
231	Pavlos Melas	1	1	1	1	1	0	0	62,71	67,65	65175	140	5	2791835	1346099
232	Paxi	1	1	1	0	0	0	0	62,98	50,91	2359	5	0	1967	226238
233	Pellia	1	1	0	1	1	0	0	62,5	50,39	67055	111	2	6052505	6341517
234	Penteli	1	1	1	0	1	1	0	74,63	54,66	26024	55	3	2901988	1160474
235	Perama	1	1	1	0	0	0	0	58,69	57,77	23234	56	4	12084034	23287142
236	Peristeri	1	1	1	1	1	1	0	61,94	62,09	118893	187	14	26399669	4381375
237	Petroupoli	1	1	1	1	1	0	0	69,1	53,09	42282	84	1	6471715	1146105
238	Pilea-Hortiatis	1	1	1	1	1	1	0	70,4	64,27	48178	113	6	4692747	2308640
239	Pineios	1	1	1	1	1	0	0	63,86	61,04	20944	28	1	351813	173614
240	Piraeus	1	1	1	0	0	0	0	55,69	55,23	155278	351	40	129372504	17284650
241	Plastiras Lake	1	1	1	1	1	0	0	64,95	58,09	8913	7	0	0	560035
242	Platanias	1	1	1	0	1	1	0	65,56	62,07	19891	36	1	1091825	806247
243	Pogoni	1	1	1	0	1	0	0	44,63	53,63	12950	29	0	915603	399915
244	Polygyros	1	1	0	1	1	1	0	70,42	66,43	25004	58	1	3996866	1183656
245	Poros	1	1	0	0	0	0	0	67,27	56,02	4259	19	0	453577	374873
246	Prespes	1	1	0	1	0	0	0	28,46	50,52	2577	4	0	0	254935
247	Preveza	1	1	1	0	1	1	0	59,17	54,74	34045	72	1	2133635	1193533
248	Prosotsani	1	1	1	0	1	0	0	51,21	56,32	18159	29	0	0	934740
249	Psara	1	1	1	0	1	1	0	69,35	51,29	562	4	0	0	18292
250	Pydna-Kolindros	1	1	0	0	1	0	0	62,13	55,91	18707	26	0	291933	1365361

	A	B	C	D	E	F	G	H	I	J	K	L	M	N	O
251	Pyli	1	1	0	0	1	1	0	63,94	52,54	24478	37	8	6161234	294912
252	Pylos-Nestor	1	1	1	1	1	1	0	47,55	51,63	24538	50	0	1911225	1130640
253	Pyrgos	1	1	1	1	0	0	0	54,01	50,65	53712	68	3	2438921	1602360
254	Rafina-Pikermi	1	1	0	1	1	1	0	76,29	57,58	13600	41	5	1181403	837327
255	Rethymno	1	1	1	1	1	1	0	65,52	50,41	44573	107	4	7246425	1227940
256	Rhodes	1	1	1	0	1	0	0	58,38	53,21	95117	340	14	38010565	6459560
257	Rigas Feraios	1	1	1	0	1	1	0	74,7	51,02	13799	23	1	53249	521681
258	Salamina	1	1	0	0	1	0	0	71,29	54,63	33491	83	8	10374346	13151903
259	Samos	1	1	1	1	1	0	0	43,3	55,45	30102	63	1	1535397	1676094
260	Samothace	1	1	0	0	1	1	0	54,67	52,15	3308	11	0	1254233	720186
261	Saronikos	1	1	1	0	1	1	0	71,77	52,28	23383	54	2	4346151	1935985
262	Serifos	0	0	0	0	0	0	0	43,56	50,61	1847	3	0	0	43351
263	Serres	1	1	1	1	1	1	0	56,85	50,02	80172	121	18	3727178	1360491
264	Servia - Velvento	1	1	0	0	0	0	0	52,55	54,55	20256	34	1	1527862	3180545
265	Sfakia	1	1	0	0	0	0	0	57,66	100	2923	6	0	23522	153329
266	Sifnos	1	1	0	0	0	0	0	71,27	54,07	3220	12	0	0	268087
267	Sikinos	1	0	0	0	0	0	0	75,88	53,28	423	2	0	0	744
268	Sikyona	1	1	1	1	1	1	0	61,35	53,51	22865	39	5	2344784	180125
269	Sintiki	1	1	0	0	0	0	0	43,72	60,35	30605	36	3	1471391	1210153
270	Sithonia	1	1	0	0	1	0	0	69,36	80,86	13101	28	0	5795177	4418750
271	Sitia	1	1	1	0	1	1	0	65,73	65,16	19051	53	3	2012934	899838
272	Skiathos	1	1	1	1	0	0	0	70,34	53,97	4992	23	1	1143886	1180588
273	Skopelos	1	1	0	1	1	0	0	55,6	53,37	5131	15	0	460560	365667
274	Skydra	1	1	1	0	1	0	0	68,23	52,23	21498	36	2	1408202	483686
275	Skyros	1	1	0	1	1	0	0	62,43	52,88	3449	10	1	554686	171800
276	Sofades	1	1	0	0	1	0	0	62,17	52	24764	34	1	1779053	631445
277	Soufli	1	1	1	1	1	0	0	55,04	53,68	18188	35	4	1633208	1381166
278	Souli	1	1	1	1	1	0	0	54,41	51,05	13789	28	1	44817	414036
279	South Kynouria	1	1	0	0	1	0	0	55,1	50,51	9686	21	0	1009168	324563
280	South Pilio	1	1	0	0	1	0	0	61,36	53,37	11316	30	1	994473	754488
281	Sparta	1	1	0	1	1	1	0	38,72	59,13	35546	73	6	1052037	403086
282	Sparta-Artemida	1	1	1	1	1	1	0	69,12	60,52	23503	88	8	3939541	2373449
283	Spetses	1	1	0	1	0	0	0	68,06	66,01	4273	11	1	0	582848
284	Styrida	1	1	1	1	0	0	0	73,6	67,73	13851	31	1	3073710	889563
285	Symi	1	1	0	0	0	0	0	43,28	55,85	2998	15	0	1514784	72641
286	Syros-Ermoupoli	1	1	0	0	0	0	0	61,58	62,96	20475	79	9	314518	1002651
287	Tanagra	1	1	1	0	1	1	0	73,08	68,49	15088	44	1	1039560	1564482
288	Tempi	1	1	1	0	1	0	0	65,3	52,89	18105	30	1	1077986	894943
289	Thassos	1	1	1	0	1	0	0	61,82	57,22	13810	25	0	163027	1597699
290	Thermaikos	1	1	1	0	1	1	0	69,26	63,35	34728	69	8	3102760	3830391
291	Thermi	1	1	1	0	1	0	0	74,61	66,89	39105	92	7	3510055	2166530
292	Thermo	1	1	0	0	0	0	0	53,8	68,25	10521	12	1	0	0

	A	B	C	D	E	F	G	H	I	J	K	L	M	N	O
293	Thessaloniki	1	1	0	1	1	1	0	57,72	58,11	269177	964	126	20873761	17308368
294	Thira	1	1	1	1	1	0	0	69,81	50,57	13018	48	5	480849	683382
295	Thiva	1	1	1	1	0	1	0	57,87	61,53	34401	74	2	2720830	1873360
296	Tilos	1	1	0	0	1	0	0	44,81	100	716	6	0	3072327	53995
297	Tinos	1	1	0	0	1	1	0	67,43	56,04	10069	28	1	716875	237382
298	Tirnavos	1	1	0	0	1	1	0	65,91	56,5	24601	22	0	493193	1585196
299	Topeiros	1	1	0	1	1	1	0	64,83	59,72	14797	18	0	458803	645981
300	Trifylia	1	1	0	0	0	0	0	46,36	53,56	28520	61	1	2837096	1699308
301	Trikala	1	1	1	1	1	1	1	63,55	53,02	77143	194	8	25226411	3786958
302	Tripoli	1	1	0	0	0	0	0	46,15	50,28	48267	117	6	1979313	942043
303	Troizinia-Methana	1	1	1	0	1	1	0	60,86	62,26	7811	12	2	1732790	734715
304	Vari-Voula-Vouliagmeni	1	1	1	1	1	1	0	68,67	50,03	36194	109	5	2828417	1327978
305	Velo-Vocha	1	1	0	0	0	0	0	65,28	50,76	17195	44	1	3819788	463038
306	Veria	1	1	1	0	1	0	0	62,45	54,1	64867	94	9	3277844	2808172
307	Viannos	1	1	1	1	1	0	0	66,78	61,52	6272	14	0	1468621	177875
308	Visaltia	1	1	0	0	1	0	0	55,66	52,37	27736	36	1	1281357	242747
309	Voio	1	1	0	0	1	0	0	52,71	56,36	24382	46	1	3138009	1988343
310	Volos	1	1	1	0	1	0	0	63,41	53,13	124659	247	17	6740089	5729524
311	Volvi	1	1	1	1	0	0	0	64,73	52,94	26005	34	0	1608264	1471436
312	Vrillissia	1	1	0	1	0	0	0	72,72	51,49	21419	44	0	4870083	1128982
313	Vyronas	1	1	1	1	1	1	0	62	59,87	43680	111	14	13765435	897773
314	West Achaia	1	1	1	0	1	0	0	66,5	50,14	30293	42	1	3232928	1260280
315	West Mani	1	1	0	0	1	0	0	53,82	53,23	7495	20	0	609686	335021
316	Xanthi	1	1	1	1	1	0	0	50,98	51,14	52473	91	3	4970378	695426
317	Xiromero	1	1	1	1	1	0	0	58,89	54,5	17174	22	1	1090155	832992
318	Xylokastro-Evrostina	1	1	1	1	1	1	0	60,12	55,85	19433	45	4	2851337	413695
319	Ydra	1	1	0	0	1	1	0	66,46	50,57	2848	6	0	0	546856
320	Zacharo	1	1	0	0	1	0	0	60,64	50,47	11776	19	0	755870	202512
321	Zagora-Mouresi	1	1	1	1	1	0	0	60,78	55,71	7267	24	0	1092813	315184
322	Zagori	1	1	0	0	0	0	0	55,02	52,83	7647	14	0	0	397653
323	Zakynthos	1	1	1	1	1	1	0	57,15	55,9	38642	94	7	1911153	2730664
324	Ziros	1	1	1	1	1	1	0	57,83	57,46	17830	36	0	992359	1714536
325	Zitsa	1	1	1	1	1	1	0	58,76	54,17	18645	39	3	135986	738992
326	Zografou	1	1	1	0	1	0	0	64,44	59,82	49523	145	8	3731171	13885476

Source of I,J,L,M,N,O: *Hellenic Ministry of Interior (2019); Hellenic Statistical Authority (2019).*



### 13.2. The Greek party system in crisis: From the ideological context to the pro-memorandum vs antimemorandum discourse

*Konstantina Kotsiopoulos*

#### Abstract

The present paper aims to present the changes noticed in the pre-election programs of the parties from 1974 to 2015, a period characterized by radical changes in the political life of Greece. For many years, the party system was based on the traditional separation of the ideological axis "Left / Right". In the pre-election programs parties were gradually showing a clear ideological position and, respectively, the voters identified with a specific party. This ideological vote prevailed for several years, until the first timid shifts of the parties in the axis, but replaced much later - at the beginning of the economic crisis in Greece - by the punitive vote. During the turbulent period starting from 2009, the party system changes radically, new parties appear in the parliamentary scene, economic stability is the main priority, key areas are set aside and the voters show strong tendencies of disapproval towards the new structured party system.

This paper attempts to make a comparative analysis of the parties' announcements in relation to the respective requirements of the memoranda. In this context, key conclusions are expected to be drawn on how the parties, from shaping their programs based on the ideology they advocated, were now forced to structure their program based on the Memorandum-Anti-Memorandum dipole.

**Keywords:** Party System, Pre-Election Programs, Memorandum-Anti-Memorandum

#### Το κομματικό σύστημα σε κρίση: Από το ιδεολογικό πλαίσιο στον μνημονιακό/αντιμνημονιακό λόγο.

*Κωνσταντίνα Κωτσιοπούλου<sup>1</sup>*

#### Εισαγωγή

Η μεταπολίτευση<sup>2</sup> αποτέλεσε αναμφίβολα τομή για το πολιτικό σύστημα της χώρας. Η μετάβαση στη δημοκρατική ομαλότητα μετατρέπεται σε πρωτεύον ζήτημα της περιόδου. Έτσι, τα πολιτικά κόμματα που δημιουργούνται, αναλαμβάνουν κομβικό ρόλο στη διαδικασία αυτής της μετάβασης και της αντίστοιχης εκκρεμούς ένταξης των μαζών στο πολιτικό σύστημα. Στο νέο αυτό πλαίσιο, τα κόμματα δομούν τα πολιτικά τους προγράμματα προκειμένου να δηλώσουν την κύρια ιδεολογία που πρεσβεύουν και τις προτάσεις/θέσεις τους σχετικά με νευραλγικούς τομείς όπως η οικονομία, η κοινωνία, η δημόσια διοίκηση και το κράτος εν συνόλω. Έτσι, οι νέοι κομματικοί σχηματισμοί που δημιουργούνται, διατηρούν σαφείς ιδεολογικές αποστάσεις από το προδικτατορικό κομματικό σύστημα και αναδεικνύονται σε πρωταγωνιστές της διαδικασίας της ομαλούς μετάβασης στη δημοκρατία, διαμορφώνοντας τα νέα δεδομένα του πολιτικού

<sup>1</sup> Υποψήφια Διδάκτωρ του Τμήματος Πολιτικής Επιστήμης και Δημόσιας Διοίκησης, Εθνικό και Καποδιστριακό Πανεπιστήμιο Αθηνών, Email: konstandina\_k@yahoo.gr

<sup>2</sup> Στα ελληνικά, χρησιμοποιείται ο όρος μεταπολίτευση για να υποδηλωθεί και να χαρακτηριστεί το πολιτικό σύστημα που προέκυψε μετά το στρατιωτικό καθεστώς της περιόδου 1967-1974.

συστήματος. Η ιδιαίτερη αυτή συμβολή τους κατά την αρχή της μεταπολιτευτικής περιόδου είναι ο λόγος που συχνά γίνεται αναφορά για μια «δημοκρατία των κομμάτων, μια κομματική δημοκρατία».

### **Ιδεολογικός άξονας Αριστερά/Δεξιά**

Κατά τις ιδρυτικές διακηρύξεις των κομμάτων αλλά και μετέπειτα στα προεκλογικά τους προγράμματα, τα κόμματα της μεταπολίτευσης τοποθετήθηκαν στον ιδεολογικό άξονα βάσει της συγκεκριμένης ιδεολογίας που πρεσβεύουν. Αν και στην ελληνική περίπτωση, η τοποθέτηση αυτή φέρει στοιχεία των προηγούμενων ιστορικών εμπειριών των κομμάτων, όσο κι αν τα νέα κόμματα ήθελαν να απαλλαγούν από τα στοιχεία που τα συνέδεαν με τους λόγους της βίαιης εγκαθίδρυσης της δικτατορίας. Έτσι, η Αριστερά και η Δεξιά θεωρούνταν πάντοτε οι κύριες διαχωριστικές γραμμές στην ελληνική πολιτική. Το νόημα αυτών των όρων ή «άδειων κουτιών» (Σαρτόρι) ποικίλλει και έχει υποστεί σημαντικές αλλαγές. Η κλίμακα αυτή αποτελεί ένα «αποτελεσματικό εύρημα για την κατανόηση και οργάνωση των πολιτικών δεδομένων». Κατά αυτό τον τρόπο, οι θέσεις των κομμάτων κατηγοριοποιούνται και εμφανίζονται αντίστοιχες αντιθέσεις και διαχωρισμοί μεταξύ τους. Έχοντας ως βασικό σκοπό την προσέλκυση της ψήφου των εκλογέων, ο άξονας εξυπηρετεί τον προσανατολισμό των ψηφοφόρων και της επικοινωνίας με το πολιτικό σύστημα καθότι μειώνει την πολυπλοκότητα της πολιτικής. Βάσει της συγκεκριμένης τοποθέτησης στον ιδεολογικό άξονα, διαπιστώνεται ότι όσο πιο κοντά αυτοτοποθετούνται τα κόμματα στην Αριστερά, παρουσιάζονται τα εξής χαρακτηριστικά: κρατική κεντρική σχεδίαση οικονομίας, κρατικός παρεμβατισμός, κοινωνική / κοινοτική ιδιοκτησία μέσω παραγωγής, μεγάλο κράτος, μεγάλη αναδιανομή εισοδήματος, προσφορά ανάλογα με δυνατότητες, λήψη σύμφωνα με τις ανάγκες, προστασία αδύναμων κοινωνικών ομάδων και μειονοτήτων, προστασία εργασιακών δικαιωμάτων, ελαστικότητα σε κάποιες μορφές παραβατικότητας, κοινωνική ισότητα και αλληλεγγύη και υποστήριξη κοινωνικών δικαιωμάτων. Αντίθετα, η τοποθέτηση στα Δεξιά παρουσιάζει τα εξής χαρακτηριστικά: ελεύθερη αγορά ως ρυθμιστής της οικονομίας, ελαχιστοποίηση κρατικού παρεμβατισμού, ατομική ιδιοκτησία μέσω παραγωγής, χαμηλή φορολογία και κρατικές δαπάνες, μικρό κράτος, μικρή αναδιανομή εισοδήματος, στήριξη μόνο των πολύ αδύναμων κοινωνικών ομάδων, απελευθέρωση αγοράς εργασίας, πατριωτισμός, εθνική ασφάλεια, νόμος και τάξη και υποστήριξη ατομικών δικαιωμάτων.

Κατά τη διάρκεια της μεταπολιτευτικής περιόδου, βλέπουμε τα κόμματα να αποσύρονται από τα άκρα του άξονα και να μετακινούνται προς το κέντρο. Ο χώρος του κέντρου μονοπώλησε αρκετά τα κόμματα τα τελευταία χρόνια καθώς είναι ο χώρος ο οποίος αποτελεί τη «μέση οδό» ανάμεσα σε ακραίες θέσεις. Κατά τον Βερναδάκη, ο «μεσαίος χώρος» αποτελεί έναν υπαρκτό και ορθολογικά δομημένο χώρο στον οποίο τα κόμματα δεν αυτοτοποθετούνται τυχαία καθώς ουσιαστικά εξυπηρετούνται από τη λειτουργία των «μεσαίων-ενδιάμεσων θέσεων» αλλά και σε «μη θέσεις» σε κρίσιμα ζητήματα της εποχής. Η αλλαγή αυτή είχε ως αποτέλεσμα τη σύγκλιση των κομματικών ή παραταξιακών ταυτίσεων, κατά την προσπάθεια αυτών να διευρύνουν την εκλογική τους επιρροή. Έτσι, όπως αναλύεται και στη συνέχεια, τα κόμματα παρουσιάζουν παλίνδρομες κινήσεις προς το κέντρο και πίσω. Επίσης, παρατηρείται η εμφάνιση νέων κομμάτων με πιο

ασαφείς διαχωριστικές γραμμές, θνησιγενή κόμματα που εν πολλοίς αποσπώνται από τη μήτρα μεγαλύτερων κομμάτων προκειμένου να δηλώσουν την αντίθεση τους με την κομματική γραμμή και να υποστηρίξουν τη δική τους θέση για το εκάστοτε διακύβευμα της εποχής.

Η περαιτέρω λειτουργία του άξονα -πέραν του ίδιου του αυτοχαρακτηρισμού των κομμάτων- είναι η προσφορά του ως δείκτη για την ταξινόμηση και την περιγραφή του κομματικού συστήματος. Κατά το μεγαλύτερο μέρος της μεταπολιτευτικής περιόδου είναι εύκολο να παρατηρήσουμε τρεις συνασπισμούς με τα δύο παραδοσιακά μεγάλα κόμματα να ανταγωνίζονται για την εξουσία, ενώ ο τρίτος να αποτελείται από τα δύο κόμματα της αριστεράς που δεν διεκδικούσαν -μέχρι πρότινος- την εξουσία με αξιώσεις. Έτσι, μέχρι και λίγα χρόνια πριν, το κομματικό σύστημα χαρακτηριζόταν «δικομματικό» αφού τα δύο μεγάλα κόμματα, Νέα Δημοκρατία και ΠΑΣΟΚ, τα οποία διεκδικούσαν την κυβερνητική εξουσία, προσέλκυαν πάνω από το 80% των ψήφων (Παππάς, 2001).

### **Από την ιδεολογική ψήφο στην ψήφο διαμαρτυρίας**

Τα νέα δεδομένα, η οικονομική κρίση και η είσοδος της χώρας στο μηχανισμό στήριξης άλλαξε άρδην το πολιτικό σκηνικό. Σταδιακά τα ποσοστά των δύο μεγάλων κομμάτων δεν συγκέντρωναν αθροιστικά το 80% και νέα κόμματα αναδεικνύονταν στο κομματικό σύστημα. Η ιδεολογική ψήφος υπό τα νέα δεδομένα παρουσιάζει στοιχεία ψήφου αντίδρασης στο εδραιωμένο κομματικό σύστημα και στα δυσμενή γεγονότα που διαδραματίζονται από το 2009 και έπειτα. Πιο συγκεκριμένα, τα αίτια γένεσης και καλλιέργειας της ψήφου αντίδρασης, είναι κυρίως οι πολιτικοοικονομικές εξελίξεις οι οποίες δημιουργούν δυσαρέσκεια στους πολίτες για το πολιτικό σύστημα εν γένει και τους οδηγούν στην πολιτική αντίδραση. Μια μεγάλη κρίση στην κοινωνία (πολιτική/οικονομική) ή κρίση αξιών οδηγεί σε πολιτική αποξένωση και σε ψήφο αντίδρασης και τιμωρίας.

Στην ελληνική πολιτική σκηνή, τα χρόνια του δικομματισμού χαρακτηρίστηκαν από κοινωνική νηνεμία και ισορροπία η οποία ευνοούσε στο να στρέφονται οι εκλογείς υπέρ του ενός από τα δύο μεγάλα κόμματα. Τα δεδομένα που διαμορφώθηκαν το 2009 και έπειτα, οδήγησαν τους απογοητευμένους εν πολλοίς εκλογείς στην τιμωρητική ψήφο, οδηγώντας το ΠΑΣΟΚ σε πρωτοφανή χαμηλά ποσοστά, στην άνοδο του ΣΥΡΙΖΑ αλλά και της Χρυσής Αυγής. Το νέο πλαίσιο ρητορείας «μνημόνιο- αντιμνημόνιο» συνέβαλε στην αύξηση των ποσοστών ψήφου διαμαρτυρίας και η κλιμάκωση αυτών ήρθε με την παραδειγματική τιμωρία της κυβέρνησης της Νέας Δημοκρατίας τον Ιανουάριο του 2015, αναδεικνύοντας στην κυβέρνηση ένα κατεξοχήν κόμμα της Αριστεράς και τοποθετημένο -αρχικά- στο αντιμνημονιακό μπλόκ. Κατά την ίδια περίοδο βλέπουμε τη δημιουργία νέων κομμάτων που εμφανίζονται ως απάντηση στην απογοήτευση των πολιτών στο παλαιοκομματικό σύστημα και στο διακύβευμα «μνημόνιο-αντιμνημόνιο».

### **Οι ιδεολογικές μετατοπίσεις στα προεκλογικά προγράμματα**

Σύμφωνα με τον Downs ο βασικότερος στόχος των κομμάτων είναι η όσο το δυνατόν μεγαλύτερη διεύρυνση της εκλογικής επιρροής, γεγονός που τα αναγκάζει να προσαρμόζουν τα προεκλογικά τους προγράμματα στα αιτήματα της κοινωνίας. Οι αλλαγές που δύνανται να προκύψουν στην κοινωνία και κατ'επέκταση στις

ανάγκες των πολιτών, τα υποχρεώνει να αναπροσαρμόζουν τα προγράμματά τους προκειμένου να απαντήσουν σε αυτές. Το εκλογικό όφελος λοιπόν λειτουργεί ως κίνητρο προκειμένου τα κόμματα να μεταβάλουν το ιδεολογικό τους προφίλ. Περαιτέρω λόγοι για τους οποίους τα κόμματα οδηγούνται στη μεταβολή των θέσεων τους είναι η αλλαγή ηγεσίας του κόμματος -εφόσον ο αρχηγός του κόμματος υποστηρίζει ένα συγκεκριμένο ιδεολογικό προσανατολισμό- η αλλαγή του ιδεολογικού προφίλ των συγγενών κομμάτων διεθνώς και η προσαρμογή στα διακυβεύματα της εκάστοτε εποχής λόγω οικονομικών ή άλλων συγκυριών.

Τα προεκλογικά προγράμματα ως δημοσιευμένα κομματικά κείμενα , προσφέρονται για την ανάλυση του περιεχομένου τους καθώς παρέχουν τη δυνατότητα της συγκριτικής τους ανάλυσης διαχρονικά αλλά και μεταξύ τους, βάσει προκαθορισμένων κριτηρίων. Επιπλέον, το προεκλογικό πρόγραμμα αποτελεί προϊόν πολιτικής ζύμωσης από τα μέλη του κόμματος, παρέχοντας τη δυνατότητα πιο ασφαλούς συμπεράσματος για το ιδεολογικό του προφίλ εν συνόλω. Προκειμένου να μελετηθεί το περιεχόμενο των προεκλογικών προγραμμάτων επιλέχθηκαν τα 3 μεγαλύτερα και επιβιώσαντα κόμματα σε όλη τη διάρκεια της μεταπολιτευτικής περιόδου , ήτοι Νέα Δημοκρατία, Πανελλήνιο Σοσιαλιστικό Κίνημα και Κομμουνιστικό Κόμμα Ελλάδος, με την προσθήκη του Συνασπισμού Ριζοσπαστικής Αριστεράς λόγω της ανάδειξης του σε κυβέρνηση το 2015.

#### ➤ *Νέα Δημοκρατία*

Οι μεταβολές που παρουσιάζονται στα προγράμματα της Νέας Δημοκρατίας οφείλονται κατά κύριο λόγο στις συχνές αλλαγές της ηγεσίας της και τις παλίνδρομες κινήσεις της προς το κέντρο του άξονα και πίσω δεξιά, σύμφωνα με το ιδεολογικό προφίλ του εκάστοτε ηγέτη της. Πιο συγκεκριμένα, η Νέα Δημοκρατία αρχικά επιλέγει να εμφανιστεί ως ένα πολυσυλλεκτικό κόμμα<sup>3</sup> αποφεύγοντας τις σαφείς ιδεολογικές αναφορές, προσπαθώντας να ακολουθήσει μια «μέση οδό» την οποία θα εντάξει τελικά στον προγραμματικό της λόγο ώστε να διευρύνει όσο το δυνατόν περισσότερο την εκλογική της επιρροή. Όπως αποδείχτηκε στις εκλογές του 1974, αυτό φάνηκε να ευνοεί τη Νέα Δημοκρατία που παρότι ήταν το μοναδικό αστικό κόμμα εξουσίας εκείνη την περίοδο, έπρεπε να απευθυνθεί, πέραν των παραδοσιακών ψηφοφόρων της δεξιάς και σε ένα πιο ριζοσπαστικό κοινό το οποίο προσέβλεπε στο δημοκρατικό μετασχηματισμό και το τέλος του μετεμφυλιακού συστήματος εξουσίας. Έτσι, η Νέα Δημοκρατία αναγκάζεται να μετατοπιστεί προς το κέντρο του άξονα «Αριστερά/Δεξιά» ώστε να καταφέρει να απαντήσει στα αιτήματα ευρύτερου φάσματος πολιτών αλλά και να καλύψει το κενό που θα μπορούσε να αξιοποιηθεί από κάποιο άλλο κόμμα.

Η ιδρυτική διακήρυξη του 1974<sup>4</sup> θέτει τις βασικές αρχές της Νέας Δημοκρατίας ως βασικού μοχλού μετάβασης στη δημοκρατική ομαλότητα. Νευραλγικοί τομείς παραμερίζονται καθώς κύριο πρόταγμα της εποχής είναι ο εκδημοκρατισμός. Κατά την περίοδο αυτή, υπό τον Κωνσταντίνο Καραμανλή, η ΝΔ

---

<sup>3</sup> Το οποίο διατυπώνεται στην ιδρυτική διακήρυξη στις 4 Οκτωβρίου 1974 «...Ότι θα υπηρετεί πάντα και μόνο τα αληθινά συμφέροντα του έθνους, που βρίσκονται πέρα και πάνω από τις παραπλανητικές ετικέτες της Δεξιάς, του Κέντρου και της Αριστεράς».

<sup>4</sup> Ιδρυτική Διακήρυξη Νέας Δημοκρατίας 4 Οκτωβρίου 1974

εμφανίζεται ιδιαίτερα μετριοπαθής και συναινετική, δίνοντας ιδιαίτερη έμφαση σε θέματα εξωτερικής πολιτικής και άμυνας. Αξίζει να σημειωθεί πως η ΝΔ συμπεριλαμβάνει στις προτεραιότητές της θέματα αριστερού χαρακτήρα όπως ο αντιμπεριαλισμός και η ενίσχυση του ρόλου του κράτους, όπου ο Κ. Καραμανλής τάσσεται υπέρ του κρατικού παρεμβατισμού.<sup>5</sup>

Επιπλέον, όσον αφορά το πολιτειακό ζήτημα η Νέα Δημοκρατία υποστήριξε την ψήφιση ενός Νέου Συντάγματος. Τα ανωτέρω προκύπτουν από τα εξής αποσπάσματα της διακήρυξης: «*Η χώρα αντιμετωπίζει αυτήν την στιγμήν πολλά και δύσκολα προβλήματα, με την επίλυση των οποίων θα επιφορτισθεί η μετεκλογική Κυβέρνηση. Πρέπει να ανασυνταχθεί και να δραστηριοποιηθεί το κράτος το οποίον αποσυνετέθη κατά την διάρκεια της επταετίας.*», «*... ένα Σύνταγμα κοινοβουλευτικής δημοκρατίας που θα ενισχύει την εκτελεστική εξουσία χωρίς όμως να περιορίζει και την ευθύνη της έναντι της Βουλής.*».<sup>6</sup>

Το 1977<sup>7</sup> η Νέα Δημοκρατία φαίνεται να εστιάζει την ατζέντα της ιδιαίτερα στην εξωτερική πολιτική, στη σχέση της με την Τουρκία και την υλοποίηση του βασικότερου σχεδίου του Κ. Καραμανλή, την ένταξη στην Ευρωπαϊκή Κοινότητα. Όσον αφορά το κράτος εν γένει, μια αναφορά εντοπίζεται στο λόγο του Κ. Καραμανλή κατά την οποία γίνεται λόγος για «αποσυντεθειμένο κράτος» ως απότοκο της επταετίας, χωρίς να προβαίνει σε συγκεκριμένες προτάσεις για την εξάλειψη αυτού.<sup>8</sup> Η αποφυγή συγκεκριμένων τοποθετήσεων του Καραμανλή για την «κάθαρση» του κρατικού μηχανισμού αποτελεί στοιχείο του αριστοτεχνικού τρόπου που διαχειρίστηκε τη διαδικασία της μετάβασης στη δημοκρατία έτσι ώστε να αποφύγει οποιαδήποτε απόπειρα εκτροπής αλλά και στο γενικότερο πλαίσιο που απαιτούσε η Νέα Δημοκρατία να διατηρήσει μια πιο ουδέτερη στάση στην πρόσληψη ιδεολογικών χρωματισμών στη ρητορική της. Ωστόσο, ο σαφής διαχωρισμός της από την περίοδο της επταετίας προκύπτει από το αντίστοιχο φυλλάδιο που η ίδια κυκλοφόρησε «Παρέλαβε χάος-έφτιαξε κράτος» αναφερόμενη στον ίδιο τον Καραμανλή. Η πρωθυπουργοκεντρική αυτή προσέγγιση οδήγησε στις εξελίξεις που έλαβαν χώρα στο πρώτο συνέδριο της ΝΔ το 1979 όπου ο ριζοσπαστικός φιλελευθερισμός υιοθετείται ως ιδεολογία του κόμματος<sup>9</sup>. Παράλληλα, εκδηλώνεται αμφισβήτηση στο πρόσωπο του Καραμανλή με αίτημα η Νέα Δημοκρατία να μετατραπεί από αρχηγικό κόμμα σε κόμμα αρχών (κίνηση της Βόλβης). Έτσι, η Νέα Δημοκρατία προχωρά στην αλλαγή σήματος, την απόκτηση μελών και

<sup>5</sup> Κατά την περίοδο αυτή, ο Κ. Καραμανλής «κατηγορήθηκε» για σοσιαλμανία. Ωστόσο αυτό δεν αποτελεί στροφή προς τα αριστερά αλλά υποδηλώνει την *πραγματική πολιτική στρατηγική του Καραμανλή όπου πρέπει πρώτα να εκσυγχρονίσει τον ίδιο τον κρατικό μηχανισμό ώστε σε δεύτερο χρόνο να τον χρησιμοποιήσει ως εργαλείο τόσο για την οργάνωση και αναπαραγωγή της ιδεολογίας όσο και για την αναβάθμιση και εγγύηση της καπιταλιστικής κερδοφορίας*. Αντίστοιχο απόσπασμα στην ιδρυτική διακήρυξη της ΝΔ αναφέρει : «...ότι η ελεύθερη οικονομία στην οποία πιστεύει η Νέα Δημοκρατία δεν μπορεί να αποκλείσει την διεύρυνση του οικονομικού τομέως τον οποίο ελέγχει το κράτος. Και η ιδιωτική πρωτοβουλία δεν μπορεί να βρει την δικαίωσή της χωρίς παράλληλη συμμετοχή των ευρύτερων λαϊκών τάξεων στην κατανομή του εθνικού προϊόντος».

<sup>6</sup> Ομιλία Κ. Καραμανλή σε συγκέντρωση στην Αθήνα 15/11/1974.

<sup>7</sup> «Οι ιδεολογικές αρχές της Νέας Δημοκρατίας» Ιούλιος 1975 και φυλλάδιο «Παρέλαβε χάος-έφτιαξε κράτος» 1977.

<sup>8</sup> Ομιλία Κ. Καραμανλή σε συγκέντρωση στην Αθήνα 18-11-1977.

<sup>9</sup> Ομιλία Κ. Καραμανλή στο Α' συνέδριο της Νέας Δημοκρατίας 1979 , Απόσπασμα : «*Η Νέα Δημοκρατία θα μπορούσε να χαρακτηριστεί ως ριζοσπαστικός φιλελευθερισμός που εβρίσκεται μεταξύ του παραδοσιακού φιλελευθερισμού και του δημοκρατικού σοσιαλισμού*»

οργάνων με ουσιαστικές αρμοδιότητες, την μετονομασία του αρχηγού σε προέδρου και από παράταξη σε κόμμα.

Έπειτα από την ανάληψη της Προεδρίας της Δημοκρατίας από τον Καραμανλή, την ηγεσία του κόμματος αναλαμβάνει ο Γ. Ράλλης ο οποίος ακολούθησε εν πολλοίς την πολιτική γραμμή του Καραμανλή με μόνη διαφορά την κατεύθυνση του προς τις νεοφιλελεύθερες ιδέες. Στην ομιλία του στο Σύνταγμα ο Γ. Ράλλης<sup>10</sup> αναφέρεται στον περιορισμό του κρατικού παρεμβατισμού και την ανάδειξη της σημαντικότητας της ιδιωτικής πρωτοβουλίας. Το 1981 η οικονομία της Ελλάδας δεν εμφανίζεται ως βέλτιστη οπότε υποχρεώνει το πρόγραμμα της ΝΔ<sup>11</sup> να επικεντρωθεί κυρίως στην ανάγκη για ανόρθωση της οικονομίας. Ωστόσο, την ίδια χρονιά χάνει τις εκλογές από το ΠΑΣΟΚ που ήρθε να καλύψει το κενό του κεντρώου χώρου, ζητώντας την «αλλαγή». Το γεγονός αυτό σε συνδυασμό με την εκλογή Αβέρωφ στην ηγεσία του κόμματος υποχρεώνει την ΝΔ σε μια δεξιά στροφή προκειμένου να συγκρατήσει το παραδοσιακό της δεξιό ακροατήριο. Δίχως να έχει σαφές επιχείρημα ενάντιο στο αίτημα της αλλαγής, επιλέγει την επιστροφή σε αναφορές στην εμφυλιοπολεμική περίοδο και στο δόγμα της εθνικοφροσύνης ως ιδεολογικής αναφοράς σε μια απόπειρα οργανωτικής συσπείρωσης. Η έντονη δυσaréσκεια των μελών του κόμματος για την ακροδεξιά αυτή στροφή οδηγεί στην αναζήτηση νέας ιδεολογικής προσέγγισης και ο φιλελευθερισμός και ο νεοφιλελευθερισμός αρχίζουν να μπαίνουν στη συζήτηση με θεωρητικούς όρους. Η εκλογή Μητσοτάκη στην αρχηγία της ΝΔ δημιούργησε στο κόμμα την πεποίθηση της ανάκτησης των χαμένων ψηφοφόρων του κέντρου καθώς ήταν ένας πολιτικός που δεν προερχόταν από τον χώρο της ιστορικής δεξιάς αλλά του κέντρου. Έτσι, ο Μητσοτάκης φαίνεται να αλλάζει την πολιτική φυσιογνωμία της ΝΔ μετατοπίζοντας την σε μια ξεκάθαρα φιλελεύθερη πορεία, απορρίπτοντας τον «συντηρητικό» χαρακτήρα που διατηρούσε μέχρι τότε.

Το 1985 το προεκλογικό πρόγραμμα της ΝΔ εστιάζει στον περιορισμό του κρατικού παρεμβατισμού, την ανάγκη ιδιωτικής πρωτοβουλίας και αποκρατικοποιήσεων. Παράλληλα, η οικονομική ευημερία είναι και πάλι στην προεκλογική της ατζέντα. Την περίοδο αυτή διαφαίνεται η έντονη επιρροή του Κ. Μητσοτάκη στις θέσεις του κόμματος οι οποίες δομούνται βάσει της ιδεολογίας του φιλελευθερισμού. Οι δύο βασικές ιδεολογικές αρχές του νεοφιλελευθερισμού που προκύπτουν από το πρόγραμμα είναι η ελευθερία της αγοράς και ο περιορισμός του κράτους και του δημόσιου τομέα από τα ακόλουθα αποσπάσματα :

- «Η ελεύθερη οικονομία και η ατομική ιδιοκτησία είναι το έδαφος όπου η σπορά της πολιτικής ελευθερίας ριζώνει».
- «...για να καταπολεμηθούν τα προβλήματα του τόπου [...] χρειάζεται περισσότερη, όχι λιγότερη οικονομική ελευθερία»

<sup>10</sup> Ομιλία Γ. Ράλλη στο Σύνταγμα στις 16-10-1981

<sup>11</sup> Προεκλογικό πρόγραμμα «Το πρόγραμμα της Νέας Δημοκρατίας θέτει τα θεμέλια μιας νέας εποχής» 1981

- «...θέλει ένα κράτος αποτελεσματικό, μικρότερο σε έκταση και ελεγχόμενο από τη δημοκρατική νομιμότητα [...] θέλει τον περιορισμό της κρατικής επεκτάσεως ιδιαίτερα στην οικονομία».

Η απομάκρυνση από τον Καραμανλικό κρατικό παρεμβατισμό σε συνδυασμό με την ήττα στις εκλογές αποτέλεσαν τους λόγους αμφισβήτησης της νεοφιλελεύθερης στροφής του κόμματος. Το τελικό ιδεολογικό αποτέλεσμα ύστερα από αυτές τις αντιδράσεις ήταν μια φιλελεύθερη έκδοση του ριζοσπαστικού φιλελευθερισμού. Ωστόσο, είναι εμφανές ότι η Νέα Δημοκρατία αφήνει στο παρελθόν τις παλιές της ιδεολογικές τοποθετήσεις περί εθνικοφροσύνης και κινείται πλέον προς τα φιλελεύθερα και νεοφιλελεύθερα ρεύματα της εποχής.

Η διετία 1989-1990 που χαρακτηρίστηκε από πολιτική αστάθεια, με τη δημιουργία κυβέρνησης συνεργασίας και τις συνεχείς εκλογικές αναμετρήσεις, είχε καθαρά πολιτικό χαρακτήρα, αναδεικνύοντας στοιχεία όπως η πάταξη της διαφθοράς και της πελατειοκρατίας σε κύριους στόχους στα προεκλογικά προγράμματα<sup>12</sup> των κομμάτων. Σε επίπεδο κρατικού παρεμβατισμού, η Νέα Δημοκρατία αναφέρεται στον περιορισμό αυτού<sup>13</sup> και τάσσεται υπέρ των αποκρατικοποιήσεων και ιδιωτικοποιήσεων που πρέπει να προωθηθούν προς χάριν της οικονομικής ευημερίας και της ανάπτυξης, στοιχεία τα οποία προστάζει η νεοφιλελεύθερη ιδεολογία που πρεσβεύει. Επιπλέον, υπάρχουν και αρκετές αναφορές σε «κάθαρση», «οι ένοχοι θα τιμωρηθούν» οι οποίες αποτέλεσαν κύρια στοιχεία που υιοθέτησε η Νέα Δημοκρατία στο λόγο της λόγω των σκανδάλων εις βάρος του ΠΑΣΟΚ, που απασχόλησαν την κοινή γνώμη εκείνη την ταραχώδη και πολιτικά ασταθή περίοδο.

Τα προγράμματα των 1990 και 1993 δεν φαίνεται να παρουσιάζουν μεγάλες διαφοροποιήσεις. Το ιδεολογικό υπόβαθρο παραμένει το ίδιο και φαίνεται να υπάρχει εμπλουτισμός με θέσεις που αφορούν θέματα κοινωνικών παροχών και νέων τεχνολογιών υπό τη γενικότερη ανάγκη εκσυγχρονισμού που απαιτεί η συγκεκριμένη χρονική περίοδος. Επιπλέον, το πολωμένο κλίμα φαίνεται να διατηρείται και εδώ με αναφορές «Παπανδρέου=λιτότητα, Παπανδρέου=λάθος», «κράτος σπατάλης ΠΑΣΟΚ». Το προεκλογικό πρόγραμμα του 1993<sup>14</sup> εν συνόλω φαίνεται να διαμορφώνεται ως ένας απολογισμός πεπραγμένων σε αρκετούς τομείς. Πιο συγκεκριμένα, οι θέσεις διαμορφώνονται υπό την προϋπόθεση της εύρυθμης λειτουργίας της κορυφής της πυραμίδας, ήτοι της οικονομίας.

Όταν το ΠΑΣΟΚ επανήλθε στην εξουσία το 1993, η ΝΔ εισήλθε σε περίοδο αναζήτησης πολιτικής ταυτότητας. Υπό την ηγεσία του Έβερτ η πολιτική γραμμή που ακολουθεί το κόμμα είναι η λαϊκή δεξιά, συμβάλλοντας στην παλίνδρομη κίνηση στον άξονα και δημιουργώντας βαθύ ρήγμα στα μέλη της ΝΔ μεταξύ της νεοφιλελεύθερης και λαϊκής δεξιάς πλευράς. Ο διχασμός αυτός θα οδηγήσει στην ήττα της στις εκλογές του 1996.

<sup>12</sup> «Το πρόγραμμα της Νέας Δημοκρατίας, Μαζί και εσύ για μια καλύτερη Ελλάδα» και Φυλλάδιο «Ετοιμοί με Νέες Ιδέες- 3+1 Λόγοι για να Ψηφίσετε Νέα Δημοκρατία» 1990.

<sup>13</sup> Φυλλάδιο Νέας Δημοκρατίας «Οικονομία: Ξανά στο δρόμο της ανάπτυξης» 1990.

<sup>14</sup> Προεκλογικό πρόγραμμα Νέας Δημοκρατίας «Πορεία Μπροστά» 1993.

Το προεκλογικό πρόγραμμα του 1996 περιλαμβάνει θέματα τα οποία δεν συμπεριλαμβάνονταν σε εξέχουσα θέση στα προηγούμενα προγράμματα της. Έτσι, γίνονται αναφορές στους τομείς της παιδείας, του περιβάλλοντος και του πολιτισμού και σε ζητήματα οικονομικής διαχείρισης. Όσον αφορά την κρατική λειτουργία επισημαίνει και πάλι την ανάγκη ιδιωτικών επενδύσεων στο γενικότερο πυλώνα που θέτει ως αναγκαίο για αναπτυξιακές πολιτικές και εκσυγχρονισμό. Ως αντιπολίτευση επιστρατεύει στο προεκλογικό της πρόγραμμα<sup>15</sup> στοιχεία που αναφέρονται στη διαφάνεια, την πάταξη της αναξιοκρατίας, της διαφθοράς και τη μείωση των κρατικών δαπανών όπως προκύπτει χαρακτηριστικά από το πρόγραμμα της: *«Περιστολή κρατικής σπατάλης, απεγκλωβισμός κράτους από αντιπαραγωγικές δραστηριότητες και η θεσμική κατοχύρωση του πολίτη από την κρατική αυθαιρεσία είναι οι άξονες της πολιτικής μας».*

Προς το τέλος της δεκαετίας του 1990 ήταν φανερό ότι οι νεοφιλελεύθερες ιδέες δεν ήταν πλέον ελκυστικές και το κόμμα επιχείρησε να συνδυάσει τον φιλελευθερισμό σε συνδυασμό με ένα κοινωνικό προφίλ. Υπό την ηγεσία του Κώστα Καραμανλή, επιχειρείται η υπέρβαση του διχασμού που προέκυψε από την ήττα του νεοφιλελευθερισμού και την πολιτική που ακολούθησε ο προκάτοχός του. Το προεκλογικό πρόγραμμα της Νέας Δημοκρατίας του 2000<sup>16</sup> «Νέο ξεκίνημα» παρουσιάζει τις βασικές θέσεις/μέτρα του κόμματος το οποίο καλείται να προσαρμοστεί στο νέο πολιτικό πλαίσιο του 21<sup>ου</sup> αιώνα. Έτσι επικεντρώνονται και εδώ σε ιδεολογικά μη φορτισμένα θέματα.

Στις εκλογές του 2004 θέτει σαν προτεραιότητα την επανίδρυση του κράτους και τη νέα μορφή διακυβέρνησης, κινούμενη στο ίδιο πλαίσιο μη ιδεολογικά χρωματισμένου ύφους. Το 2004 το μανιφέστο για την επανίδρυση του κράτους<sup>17</sup> δίνει τις κατευθυντήριες γραμμές για την αναδιάρθρωση της Δημόσιας Διοίκησης και την ενίσχυση της Τοπικής Αυτοδιοίκησης. Πρόκειται για έναν εκτενή «χάρτη» αναδιάρθρωσης και ανασύστασης του κράτους και της δημόσιας διοίκησης εν συνόλω ο οποίος περιλαμβάνει όλους τους τομείς που σχετίζονται με αυτή. Όσον αφορά τη θέση του κόμματος για τον κρατικό παρεμβατισμό συναντάμε και πάλι την ανάγκη για τον περιορισμό του και την προαγωγή των ιδιωτικοποιήσεων.

Το 2007 το πρόγραμμα της Νέας Δημοκρατίας βασίστηκε κυρίως στον απολογισμό πεπραγμένων από το 2004 έως το 2007, συμπεριλαμβάνοντας την κατάσταση που παρέλαβε και στη συνέχεια τη διατύπωση των πολιτικών που προχώρησε. *«Στα τριάμισι χρόνια που πέρασαν, έγιναν πολλά. Έχουμε, όμως, να κάνουμε πολλά περισσότερα. Ιδίως, μάλιστα, για την πλήρη εξυγίανση των δημόσιων οικονομικών και την εδραίωση της δυναμικής ανάπτυξης που πετύχαμε. Αλλά και, προπάντων, για να δώσουμε νέα δυναμική, νέα ταχύτητα, στη μετάβαση σ' ένα Κράτος πραγματικά αποτελεσματικό. Κράτος ουσιαστικά κοινωνικό, που να βρίσκεται δίπλα σ' όσους έχουν μεγαλύτερη ανάγκη.»*<sup>18</sup> Παράλληλα, αναφέρεται στους άξονες προτεραιότητας της και οι οποίοι

<sup>15</sup> Προεκλογικό πρόγραμμα Νέας Δημοκρατίας «Δέσμευση για την Ελλάδα» 1996.

<sup>16</sup> Προεκλογικό πρόγραμμα Νέας Δημοκρατίας «Υπάρχει καλύτερη Ελλάδα και τη θέλουμε» 2000, «Νέο ξεκίνημα-2000».

<sup>17</sup> «Το κυβερνητικό μας πρόγραμμα για τη Δημόσια Διοίκηση και την Τοπική Αυτοδιοίκηση» 2004.

<sup>18</sup> Φυλλάδιο Νέας Δημοκρατίας «Μαζί πάμε την Ελλάδα μπροστά» 2004.



αφορούν κυρίως κοινωνικούς τομείς (αγρότες, κοινωνική ασφάλιση, μεγάλα έργα υποδομών, νέοι, περιβάλλον, παιδεία, μικρομεσαίες επιχειρήσεις, υγεία, γυναίκα, απασχόληση, νέες τεχνολογίες, οικονομία).

Το 2009 οι εκλογές πραγματοποιήθηκαν υπό ένα αρκετά πολωμένο κλίμα. Η Νέα Δημοκρατία θέτει ως προτεραιότητα την αντιμετώπιση της διεθνούς οικονομικής κρίσης μέσω της υιοθέτησης υπεύθυνης δημοσιονομικής πολιτικής, το νοικοκύρεμα του κράτους, τις αλλαγές που πρέπει να λάβουν χώρα ως προς το πάγωμα των μισθών, των συντάξεων και των προσλήψεων. Έτσι, αλλάζει άρδην τον πολιτικό της λόγο ο οποίος γίνεται καθαρά διαχειριστικός και το προεκλογικό της πρόγραμμα<sup>19</sup> περιλαμβάνει τα αναγκαία μέτρα που πρέπει να υιοθετήσει.

Η αλλαγή της ηγεσίας του κόμματος κατά το 2009 και η ανάληψη της αρχηγίας από τον Αντ. Σαμαρά μετατοπίζει την πολιτική γραμμή του κόμματος στη λαϊκή δεξιά, όπου βασίζεται στις μεταρρυθμίσεις και τις προσπάθειες σταθεροποίησης. Τα πολιτικά προγράμματα που παρουσίασε ο Αντ. Σαμαράς κατά τις συγκεντρώσεις στο Ζάππειο, αποτελούν τις θέσεις του κόμματος κατά τα πρώτα χρόνια εισόδου της χώρας στο μηχανισμό στήριξης. Η ρητορική του μνημονιακού-αντιμνημονιακού πλαισίου έχει ως σημείο αφετηρίας το 2010, όπου η ΝΔ τάχθηκε αρχικά κατά της ψήφισης ενώ στη συνέχεια ψήφισε το δεύτερο μνημόνιο «προς αποφυγή δυσμενέστερων γεγονότων». Κατά το έτος 2012, το πρόγραμμα της ΝΔ περιλαμβάνει ως κύριο το θέμα την οικονομική σταθεροποίηση και την «έξοδο της χώρας από την κρίση».

Πριν τις πρώτες εκλογές του 2015, η ΝΔ παρουσιάζει το αναπτυξιακό σχέδιο Ελλάδα 2021<sup>20</sup> και δίνει έμφαση στη φορολογική πολιτική. Παράλληλα προβαίνει στον απολογισμό της δράσης της και επισημαίνει τη δραστική μείωση της απασχόλησης στο δημόσιο τομέα, την εισαγωγή αξιολόγησης και λογοδοσίας και το ηλεκτρονικό κράτος (ηλεκτρονική εφορία). Στους στόχους της συμπεριλαμβάνει την καταπολέμηση της διαφθοράς και την ενίσχυση της αξιοπιστίας και της διαφάνειας. Ως προς την κρατική λειτουργία, επισημαίνεται η ανάγκη για επενδύσεις, αξιοποίηση της δημόσιας περιουσίας και πρόωθηση αποκρατικοποιήσεων.

Στις δεύτερες εκλογές του 2015, η Νέα Δημοκρατία με το σύνθημα «όλοι μαζί πάμε την Ελλάδα μπροστά» θέτει ως προτεραιότητα τη σύσταση εθνικής ομάδας διαπραγμάτευσης και εθνικό σχέδιο ανασυγκρότησης της χώρας. Στο πλαίσιο της αναδιοργάνωσης του κράτους ώστε αυτό να είναι αποτελεσματικότερο, προτείνει το «νέο εθνικό πρόγραμμα μεγάλων αλλαγών».

### ➤ ΠΑΣΟΚ

Το ΠΑΣΟΚ της πρώτης περιόδου της μεταπολίτευσης φαίνεται να συμμορφώνεται στις επιταγές της κοινωνικής συγκυρίας και να θέτει κι αυτό ως βασικότερο στόχο τον εκδημοκρατισμό, στοιχείο που διατηρεί ως πρωτεύον ζήτημα στα προεκλογικά του προγράμματα ως το 1989.

<sup>19</sup> Προεκλογικό πρόγραμμα Νέας Δημοκρατίας «Απόφαση Ευθύνης» 2009.

<sup>20</sup> «Το αναπτυξιακό πρόγραμμα της Νέας Δημοκρατίας-Ελλάδα 2021» 2015.

Το 1974, με την ιδρυτική διακήρυξη που παραχωρεί φαίνεται να θέτει τις βασικές κατευθυντήριες γραμμές του κόμματος, να καθορίζει την ιδεολογία του και να περιλαμβάνει τα βασικά προβλήματα που χρήζουν αντιμετώπισης, σε δευτερεύον -ωστόσο- στάδιο, καθώς ο εκδημοκρατισμός είναι το μόνο και κύριο διακύβευμα της περιόδου. Γι' αυτό το λόγο συμπεριλαμβάνει στο πρόγραμμά του αναφορές «λαϊκής κυριαρχίας», «εξυγίανσης» και «αποκατάστασης της δημοκρατικής λειτουργίας» του κρατικού μηχανισμού από τα κατάλοιπα της επταετίας. Ως 4 βασικούς στόχους θέτει : 1) την εθνική ανεξαρτησία, 2) λαϊκή κυριαρχία 3) κοινωνική απελευθέρωση και 4) τη δημοκρατική διαδικασία.

Με το προεκλογικό πρόγραμμα του 1977<sup>21</sup> και το γενικότερο πρόταγμα της «αλλαγής» το ΠΑΣΟΚ εμφανίζεται ως ένα ιδιαίτερα ριζοσπαστικό κόμμα, επικεντρώνοντας το ενδιαφέρον του σε ζητήματα όπως η δημοκρατία, η κοινωνική δικαιοσύνη και ο αντιιμπεριαλισμός. Ωστόσο, παρατηρούνται και αρκετά στοιχεία ενός πιο σύγχρονου και λιγότερου ριζοσπαστικού λόγου, χαρακτηριστικά παραδείγματα αποτελούν η χρήση νέων τεχνολογιών και η αποκέντρωση η οποία αποτυπώθηκε και στην πρόσληψη της σχέσης «περιφέρειας-μητρόπολης» με στόχο την ενδυνάμωση της περιφέρειας, ως στοιχείο της ρητορικής της «ελληνοποίησης» όσον αφορά τις διεργασίες μετασχηματισμού του κράτους (Κοτζιάς, 1986).

Λίγο πριν την έναρξη της κυβερνητικής του θητείας, το 1981,<sup>22</sup> το ΠΑΣΟΚ, διανέμει το «Συμβόλαιο με το Λαό», εγκαινιάζοντας μια περίοδο όπου βασικές αναφορές γίνονται στη «λαϊκή κυριαρχία» και τη δημοκρατία, έννοιες οι οποίες συνδέθηκαν με τον δημοκρατικό προγραμματισμό και την αποκέντρωση, μέσω της μεταφοράς εξουσιών από την κεντρική στην τοπική αυτοδιοίκηση. Ο δημοκρατικός προγραμματισμός σύμφωνα με το ΠΑΣΟΚ αποτελεί κομβικό σημείο για το σχεδιασμό, την υλοποίηση και τον έλεγχο της αναπτυξιακής πολιτικής σε συνδυασμό με τη λειτουργία του ως συνδετικού κρίκου ανάμεσα στην κεντρική κυβέρνηση και την τοπική αυτοδιοίκηση (Σπανού, 1998).

Κατά το πέρας της κυβερνητικής του θητείας και συγκεκριμένα το 1985, το προεκλογικό πρόγραμμα του ΠΑΣΟΚ<sup>23</sup>, διατηρεί τις ίδιες θέσεις για τη συνέχιση της αποκέντρωσης και του δημοκρατικού προγραμματισμού ενώ παράλληλα δομείται βάσει του απολογισμού των δράσεων του κατά την τετραετία της διακυβέρνησής του («δημιουργικό έργο της τετραετίας της «αλλαγής»). Το ΠΑΣΟΚ εστιάζει σταδιακά σε θέματα τα οποία δεν ήταν ιδεολογικά χρωματισμένα, όπως η εισαγωγή νέων τεχνολογιών, η αναβάθμιση της παιδείας και η προώθηση του πολιτισμού. Παράλληλα, εισάγει το θέμα της αύξησης των κοινωνικών παροχών το οποίο εξελίσσεται σε ζήτημα υψηλής προτεραιότητας. Μοναδικό κοινό σημείο των προγραμμάτων αυτής της περιόδου με εκείνα της πρώτης είναι η έμφαση στην ανάγκη περιφρούρησης της δημοκρατίας, καθώς κανένα από τα υπόλοιπα προβαλλόμενα θέματα δεν είχε τονιστεί ιδιαίτερα την περίοδο 1974-1981. Η ανάγκη

<sup>21</sup> Διακήρυξη του Προέδρου του ΠΑΣΟΚ Α. Παπανδρέου προς τον ελληνικό λαό 1977 και «Κατευθυντήριες Γραμμές κυβερνητικής πολιτικής» 1977.

<sup>22</sup> Διακήρυξης Κυβερνητικής Πολιτικής ΠΑΣΟΚ «Συμβόλαιο με το Λαό» 1981.

<sup>23</sup> Προεκλογικό Πρόγραμμα ΠΑΣΟΚ «Μαζί για τη νέα νίκη και τώρα πάλι ΠΑΣΟΚ για ακόμη καλύτερες μέρες-Απολογισμός στο λαό-διάλογος με τον πολίτη» 1985 και Φυλλάδιο ΠΑΣΟΚ «40 χρόνια Δεξιά-4 χρόνια αλλαγή».

να ανταποκριθεί στα αιτήματα της κοινωνίας αναγκάζει το ΠΑΣΟΚ να υιοθετήσει ένα διαφορετικό προφίλ σε σχέση με την προηγούμενη περίοδο.

Υπό το πολωμένο κλίμα του 1989-90, το ΠΑΣΟΚ έχοντας ήδη κάνει στροφή προς ένα πιο διαχειριστικό τρόπο διακυβέρνησης στο δεύτερο μισό της θητείας του, συμπεριλαμβάνει στα προγράμματά του<sup>24</sup> παρόμοιες θέσεις οι οποίες αφορούν στην ενίσχυση της Τοπικής Αυτοδιοίκησης<sup>25</sup> μέσω της ανεξαρτησίας και της οικονομικής αυτοτέλειας. Για την λειτουργία της κρατικής παρέμβασης τάσσεται πλέον υπέρ της ιδιωτικής πρωτοβουλίας. Επίσης, είναι η τελευταία φορά που εμφανίζεται στα προγράμματα του η ανάγκη εκδημοκρατισμού καθότι έπειτα εγκαινιάζεται η περίοδος του εκσυγχρονισμού ως κύριου ζητήματος της επικείμενης εποχής.

Κατά το έτος 1993 το κύριο πρόταγμα του ΠΑΣΟΚ είναι η «Αναγέννηση» και βάσει αυτού δομείται το τρίπτυχο που ακολουθεί α) αποκέντρωση, β) δημοκρατικός προγραμματισμός και γ) τοπική αυτοδιοίκηση. Επιπλέον, το κόμμα στρέφεται προς ένα ιδεολογικά μη φορτισμένο και διαχειριστικό λόγο προβάλλοντας ζητήματα όπως η παιδεία, ο πολιτισμός, το περιβάλλον, η παραγωγικότητα και η αποτελεσματική διακυβέρνηση. Από το 1993 έως και το 2000 το ΠΑΣΟΚ συμμορφώνεται όπως και η ΝΔ στο αίτημα της εποχής το οποίο ήταν αυτό του εκσυγχρονισμού, δομώντας το προεκλογικό του πρόγραμμα βάσει αυτού του πλαισίου.

Πριν την επάνοδο στην εξουσία το 1996 απαλλαγμένος από ιδεολογικούς χρωματισμούς και πιο πολύ τεχνοκρατικά δομημένος ο λόγος του ΠΑΣΟΚ επικεντρώνεται σε 3 βασικούς στόχους : α) εκσυγχρονισμός και ανάπτυξη οικονομίας β) οικοδόμηση σύγχρονου κράτους και γ) θέση πρωταγωνιστή στο νέο γεωπολιτικό περιβάλλον Βαλκάνια-Μεσόγειο με ισότιμη και δυναμική συμμετοχή στην εξέλιξη της ΕΕ. Η «σοσιαλδημοκρατική ρητορική» δίνει πλέον τη θέση της σε αναφορές στην «κεντροαριστερά» και την «ευρωαριστερά» (Βερναρδάκης, 2004) στο πλαίσιο της μετάβασης από το κύριο διακύβευμα της προηγούμενης εποχής, ήτοι του εκσυγχρονισμού σε αυτό της νέας εποχής που διανύεται, του εξευρωπαϊσμού (Lyrizis, 2005).

Το κυβερνητικό πρόγραμμα του ΠΑΣΟΚ για την τετραετία 2000-2004<sup>26</sup> δε διαφοροποιείται ουσιαστικά, καθώς συμπεριλαμβάνει αρκετές θέσεις που είχε υιοθετήσει και στο προηγούμενο. Το ΠΑΣΟΚ συμπεριλαμβάνει στον απολογισμό του της κομβικής σημασίας μεταρρυθμίσεις: ίδρυση ανεξάρτητων αρχών, αποκέντρωση διοίκησης και εφαρμογή σχεδίου «Καποδίστρια». Κατά το προεκλογικό πρόγραμμα του 2004<sup>27</sup>, η ρητορική του ΠΑΣΟΚ αλλάζει από το προηγούμενο «εκσυγχρονιστικό» πλαίσιο, δεδομένης της αλλαγής της ηγεσίας και του προτάγματος «αλλαγής εποχής» η οποία εστιάζει στην καθημερινότητα του πολίτη,

<sup>24</sup> ΠΑΣΟΚ «Το πρόγραμμα της τρίτης τετραετίας» 1989.

<sup>25</sup> ΠΑΣΟΚ «Τοπική Αυτοδιοίκηση- Οι θέσεις μας- Αυτή είναι η αλήθεια, Αυτή είναι η πραγματικότητα, Αυτή είναι η προοπτική» 1989.

<sup>26</sup> Προεκλογικό Πρόγραμμα ΠΑΣΟΚ «2000-2004 Οι δεσμεύσεις μας για τη νέα τετραετία» 2000.

<sup>27</sup> «2004 – 2008 Το Κυβερνητικό Πρόγραμμα του ΠΑΣΟΚ. Το σχέδιο για τη χώρα .Η αντίληψή μας.Οι προτάσεις μας» 2004.

συμμετοχική δημοκρατία, την πράσινη ανάπτυξη, την ηλεκτρονική διακυβέρνηση και την μακροοικονομική σταθερότητα.

Με το προεκλογικό πρόγραμμα του 2007 το ΠΑΣΟΚ<sup>28</sup> πολώνει το πολιτικό σκηνικό διανέμοντας τη «βίβλο αναξιοπιστίας, 3 χρόνια κυβέρνηση ΝΔ-3 χρόνια εξαπάτησης του πολίτη» συνδυαστικά με την προβολή των σποτ για τα ομόλογα. Το ΠΑΣΟΚ καυτηριάζει την πολιτική της Νέας Δημοκρατίας αναφερόμενο σε κομματική άλωση, διόγκωση της γραφειοκρατίας και των υπουργείων και κρατική σπατάλη. Η ρητορική του επικεντρώνεται στην ενίσχυση της πολιτικής αντιπαράθεσης.

Το 2009 το προεκλογικό πρόγραμμα<sup>29</sup> του βασίζεται σε 6 μεγάλους εθνικούς στόχους ως απάντηση στην πολύπλευρη πολιτική, οικονομική και κοινωνική κρίση οι οποίοι είναι: ανάταξη οικονομίας, πράσινη ανάπτυξη, κοινωνικό κράτος, παιδεία-πολιτισμός, πολιτικό σύστημα και κράτος στην υπηρεσία του πολίτη. Η προεκλογική καμπάνια βασίζεται στο σλόγκαν «Πρώτα ο πολίτης» και στο «'Η αλλάζουμε ή βουλιάζουμε». Είναι η περίοδος που το ΠΑΣΟΚ κατηγορήθηκε για τον έντονο λαϊκισμό που υιοθέτησε στους λόγους του.

Όπως είναι αναμενόμενο από το 2012 τα νέα δεδομένα που διαμορφώθηκαν στην Ελλάδα (οικουμενική κυβέρνηση, ένταξη στο μηχανισμό στήριξης, πολυκομματική βουλή) το προεκλογικό πρόγραμμα του ΠΑΣΟΚ μονοπωλείται από το εθνικό σχέδιο ανασυγκρότησης και ανόρθωσης της πατρίδας, υιοθετώντας έναν αρκετά μινιμαλιστικό και διαχειριστικό λόγο που καταδεικνύει την ανάγκη για συμμόρφωση με τις ευρωπαϊκές επιταγές. Ήταν και εκείνες οι εκλογές που το ΠΑΣΟΚ φάνηκε να βιώνει αισθητά τη δυσαρέσκεια των πολιτών και για πρώτη φορά στην κοινοβουλευτική του πορεία σημείωσε τόσο χαμηλά ποσοστά. Οι εκλογές αυτές αποτελούν και την έναρξη ενός νέου πολιτικού σκηνικού και την πτώση του γνωστού μέχρι τότε δικομματισμού.

Στο ίδιο πλαίσιο συμμόρφωσης με τις ευρωπαϊκές επιταγές κινούνται τα προγράμματα του 2012<sup>30</sup> και 2015<sup>31</sup> του ΠΑΣΟΚ, περιλαμβάνοντας θέσεις με τις οποίες δίνεται έμφαση στην προοδευτική Ελλάδα που πλέον χρήζει διαρθρωτικών αλλαγών. Ως Δημοκρατική Συμπαράταξη στις δεύτερες εκλογές του 2015 επισημαίνει την ανάγκη αναδιάρθρωσης του ελληνικού χρέους.

### ➤ *Κομμουνιστικό Κόμμα Ελλάδας*

Κατά την ανάλυση των θέσεων του ΚΚΕ διαχρονικά προκύπτει η απουσία ουσιαστικών αλλαγών στους προεκλογικούς του λόγους. Το περιεχόμενο δεν παρουσιάζει διαφορές αλλά εμπλουτίζεται μονάχα κατά την περίοδο της συνεργασίας του με τον Συνασπισμό. Κατά την πρώτη δεκαετία 1974-1985 το ΚΚΕ συμπεριλαμβάνει στις διακηρύξεις του τα βασικά αιτήματα της πρώτης μεταπολιτευτικής περιόδου, ήτοι εκδημοκρατισμός, λαϊκή κυριαρχία, ελευθερία, αντιιμπεριαλισμός. Στο συλλογικό εκλογικό πρόγραμμα της

<sup>28</sup> Προεκλογικό πρόγραμμα ΠΑΣΟΚ «Για μια δίκαιη κοινωνία, για μια δυνατή Ελλάδα» και «Βίβλος αναξιοπιστίας: 3 χρόνια κυβέρνηση ΝΔ-3 χρόνια εξαπάτησης του Πολίτη» 2007.

<sup>29</sup> Πλαίσιο κυβερνητικού προγράμματος ΠΑΣΟΚ «Πρώτα ο πολίτης» 2009.

<sup>30</sup> ΠΑΣΟΚ «12+1 Σημεία για την Εθνική Ανασυγκρότηση» 2012.

<sup>31</sup> ΠΑΣΟΚ «Θέσεις για την Ελλάδα του Αύριο- Τώρα μαζί μπορούμε, Αλλαγή Σελίδας με Σταθερότητα και Ασφάλεια» 2015.

Ενωμένης Αριστεράς<sup>32</sup> του 1974 παρουσιάζονται τα άμεσα μεγάλα εθνικά θέματα τα οποία είναι α) ο εκδημοκρατισμός β) η οικονομική και εθνική ανεξαρτησία και γ) τα μέτρα για την οικονομική πολιτική. Στο πλαίσιο του πολιτειακού ζητήματος η Ενωμένη Αριστερά τάσσεται υπέρ της ψήφισης Νέου Συντάγματος και της Αβασίλευτης Δημοκρατίας.

Στο προεκλογικό πρόγραμμα<sup>33</sup> του 1977 το ΚΚΕ όσον αφορά «τον εκδημοκρατισμό της δημόσιας ζωής» και την «δημοκρατική πορεία της χώρας» το ΚΚΕ υπόσχεται να συνεχίσει τον αγώνα ώστε α) *Να καταργηθούν τα αντιλαϊκά και αντιδημοκρατικά νομικά μέτρα του αυταρχικού καθεστώτος που παραβιάζουν τα δικαιώματα και τις ελευθερίες του λαού.* β) *Να εκδημοκρατιστεί το συνδικαλιστικό κίνημα. Να αποκρουστεί κάθε προσπάθεια επιβολής κρατικού συνδικαλισμού και να σταματήσει κάθε κρατική επέμβασης στις συνδικαλιστικές οργανώσεις. Να κατοχυρωθεί ανεξαρτησία και από τους απέναντι στο κράτος και την εργοδοσία.* γ) *Να σταματήσει ο παρεμβατισμός του κράτους στους αγροτικούς συνεταιρισμούς, στους συλλόγους και στις άλλες οργανώσεις του λαού.* δ) *Να εκκαθαριστούν από τις θέσεις κλειδιά του κρατικού μηχανισμού τα χουντικά και φασιστικά στοιχεία, ιδιαίτερα από το στρατό τα σώματα ασφαλείας και την δικαιοσύνη.* ε) *Να αναθεωρηθεί το Σύνταγμα με κατεύθυνση την κατάργηση των αντιδημοκρατικών διατάξεων. Να ενισχυθούν οι εξουσίες του κοινοβουλίου και των άλλων δημοκρατικών θεσμών. Να καθιερωθεί η απλή αναλογική σαν μόνιμο εκλογικό σύστημα.*

Το προεκλογικό πρόγραμμα του ΚΚΕ<sup>34</sup> για το 1981 περιλαμβάνει αντίστοιχες θέσεις με το προηγούμενο συμπεριλαμβάνοντας την ανάγκη να σταματήσει ο παρεμβατισμός του κράτους στις συνδικαλιστικές οργανώσεις των εργατοϋπαλλήλων, στους αγροτικούς συνεταιρισμούς και συλλόγους, και στις άλλες οργανώσεις του λαού. Επιπλέον, προτείνει την αναθεώρηση του Συντάγματος προκειμένου να καταργηθούν όλες οι αντιδημοκρατικές διατάξεις υπερεξουσίες του προέδρου καθώς και οι διατάξεις που παραχωρούν αποικιακά προνόμια στα ξένα και ντόπια μονοπώλια.

Η περίοδος 1985-1991 αποτελεί εκείνη που το ΚΚΕ επιχειρεί μια στροφή προς τη «διακυβέρνηση» και ένα άνοιγμα προς πολιτικές και κοινωνικές δυνάμεις. Η περίοδος αυτή θα σημαδευτεί από την προσπάθεια μιας νέας ενωτικής προσπάθειας στο χώρο της Αριστεράς και στη δημιουργία του Συνασπισμού, αλλά και από τη στροφή του κόμματος σε θέσεις περισσότερο «συστημικές». Την περίοδο 1989-1990 εισέρχεται στην εκλογική μάχη σε συνεργασία με την ΕΑΡ και άλλες δυνάμεις της ευρύτερης Αριστεράς, έχοντας συγκροτήσει τον Συνασπισμό της Αριστεράς και της Προόδου. Όπως ήταν αναμενόμενο, ο πολιτικός λόγος διαφοροποιείται παρότι διατηρείται εν μέρει το ίδιο μοτίβο αριστερού λόγου και τα προγράμματα εμπλουτίζονται με θέματα της ανανεωτικής πτέρυγας. Το 1991 το ΚΚΕ θα αποχωρήσει από τον Συνασπισμό βιώνοντας τη δεύτερη μεγάλη διάσπαση μετά το 1968 με την αποχώρηση σχεδόν του μισού στελεχιακού του δυναμικού το οποίο παραμένει στο Συνασπισμό ως συνιστώσα. Το ΚΚΕ θα λάβει στις εκλογές του 1993 4.5%, το χαμηλότερο

<sup>32</sup> Εκλογικό Πρόγραμμα Ενωμένη Αριστερά 1974.

<sup>33</sup> Εκλογικό Πρόγραμμα ΚΚΕ 1977.

<sup>34</sup> Εκλογικό Πρόγραμμα ΚΚΕ «για να φύγει, η δεξιά, για την αλλαγή» 1981

εκλογικό του ποσοστό από την εποχή του μεσοπολέμου. Συνοπτικά, τα κύρια θέματα που περιλάμβαναν τα προεκλογικά του προγράμματα ήταν :

- το 1993<sup>35</sup> θέσεις κατά του ιμπεριαλισμού και της αναγκαιότητας σοσιαλισμού, καθώς «ο καπιταλισμός αδυνατεί να αντιμετωπίσει τα σύγχρονα προβλήματα»
- το 1996<sup>36</sup> δομείται βάσει της εξωτερικής πολιτικής που προτείνει το ΚΚΕ ως αντιιμπεριαλιστικό, αντιμονοπωλιακό μέτωπο
- το 2000<sup>37</sup> επικεντρώνεται σε θέσεις κατά της παγκοσμιοποίησης
- το 2004<sup>38</sup> εξάρει τη μαρξιστική - λενινιστική ιδεολογία, στις αρχές και τις αξίες του κινήματος
- το 2007 : κατά του “πιο μικρού και αποτελεσματικού κράτους” που εξυπηρετεί την καπιταλιστική δομή
- το 2009 : αντι-ιμπεριαλισμός, πολιτική κυριαρχία
- το 2012 : αντιλαϊκά μέτρα
- το 2015: ισχυροποίηση αντιευρωπαϊκής θέσης, αντιμνημονιακός λόγος.

➤ **Συνασπισμός -ΣΥΡΙΖΑ**

Ως χρόνο εκκίνησης της ανάλυσης των προεκλογικών προγραμμάτων του Συνασπισμού και αργότερα ΣΥΡΙΖΑ λαμβάνουμε το 1996.

- Το προεκλογικό πρόγραμμα του 1996 έχει ως βασική προτεραιότητα τον προοδευτικό εκσυγχρονισμό θέτοντας τα θεμέλια της ανανεωτικής πτέρυγας της Αριστεράς.
- Το 2000 θέτει ως βασικούς πυλώνες την αντιμετώπιση της ανεργίας, την προάσπιση των εισοδημάτων των αδύναμων στρωμάτων, την ανακατανομή των εξουσιών και την ανασυγκρότηση του παραγωγικού ιστού.
- Το 2004 το πρόγραμμα<sup>39</sup> φαίνεται να επικεντρώνεται σε οικονομικά και αναπτυξιακά θέματα όπως οι μεγάλες δημόσιες επενδύσεις, οι ιδιωτικοποιήσεις και η συνεπαγόμενη εκποίηση του δημόσιου πλούτου, η προστασία και η αναβάθμιση του δημόσιου τομέα. Επιπλέον, εμπλουτίζεται με αναφορές στην υγεία, την παιδεία, και την κοινωνία.
- Το 2007<sup>40</sup> υιοθετεί τη ρητορική της κατάδειξης των εσφαλμένων πολιτικών των κυβερνώντων κομμάτων, κυρίως σε ότι αφορά τις ιδιωτικοποιήσεις και τις εργασιακές σχέσεις.

<sup>35</sup> Εκλογική Διακήρυξη «η αριστερή απάντηση» 1993.

<sup>36</sup> Σχέδιο Προγράμματος της Κεντρικής Επιτροπής του Κομμουνιστικού Κόμματος Ελλάδος 1996 και Εκλογική Διακήρυξη ΚΚΕ «Αντεπίθεση λαέ με ισχυρό ΚΚΕ» 1996.

<sup>37</sup> Διακήρυξη της ΚΕ του ΚΚΕ προς τον ελληνικό λαό 2000 και Θέσεις της ΚΕ του ΚΚΕ για το 16ο Συνέδριο του Κόμματος 2000.

<sup>38</sup> Θέσεις της Κεντρικής Επιτροπής του ΚΚΕ στο 17ο Συνέδριο 2004.

<sup>39</sup> Εκλογική Διακήρυξη ΣΥΡΙΖΑ 2004 «Το νέο γεννιέται στα κινήματα, το μέλλον είναι αριστερά».

<sup>40</sup> «Ενωτικά και αριστερά κάνουμε τα αδύνατα δυνατά» ΣΥΡΙΖΑ 2007.

- Το 2009<sup>41</sup>, ο ΣΥΡΙΖΑ αναφέρεται στην οικονομική κρίση και καταδεικνύει τα κυβερνώντα κόμματα ως υπεύθυνα λόγω των πολιτικών που ακολούθησαν στο παρελθόν. Επιπλέον, αναφέρεται στα αντιλαϊκά μέτρα τα οποία δεν διατίθεται να ψηφίσει, προκειμένου να προστατεύσει τους κοινωνικά αδύναμους.
- Στο ίδιο πλαίσιο με τα υπόλοιπα κόμματα το 2009 αναφερόμενο στην οικονομική κρίση προτείνει λύσεις εξόδου από αυτήν, υιοθετώντας σταδιακά έναν πολιτικό λόγο που έχει έντονα στοιχεία λαϊκισμού.
- Κατά το έτος 2012<sup>42</sup>, ο ΣΥΡΙΖΑ ενισχύει το κλίμα πόλωσης με το σλόγκαν Μνημόνιο ή ΣΥΡΙΖΑ. Υπόσχεται την κοινωνικά δίκαιη δημοσιονομική εξυγίανση και την έξοδο της χώρας από την κρίση.
- Στο ίδιο πλαίσιο πόλωσης, το 2015<sup>43</sup> ως προτεραιότητα θέτει τη διαγραφή του χρέους, τη ρήτρα ανάπτυξης στην αποπληρωμή του υπόλοιπου χρέους και την ποσοτική χαλάρωση με απευθείας αγορά κρατικών ομολόγων από την ΕΚΤ. Το σλόγκαν της εποχής είναι «θα σκίσουμε τα μνημόνια».

Αν και αρχικά κόμμα του αντιμνημονιακού μπλοκ, μετά τις δυσμενείς συνθήκες διαπραγμάτευσης αλλάζει άρδην τον προεκλογικό του λόγο και στο προεκλογικό πρόγραμμα των δευτέρων εκλογών του 2015 θέτει ως προτεραιότητες το δημόσιο χρέος, τις εργασιακές σχέσεις, το ασφαλιστικό σύστημα, τις συντάξεις, την αξιοποίηση της δημόσιας περιουσίας και το φορολογικό σύστημα. Έτσι φαίνεται να συμμορφώνει το προεκλογικό του πρόγραμμα σύμφωνα με τις ευρωπαϊκές πλέον επιταγές. Ειδικότερο ενδιαφέρον παρουσιάζει η σχέση του ΣΥΡΙΖΑ με την ψήφο αντίδρασης. Σύμφωνα με τον Μαραντζίδη στις αρχές της κρίσης, *η ψήφος το 2012 προς αυτόν, με τη ριζοσπαστική ρητορική του, ήταν μια ψήφος αντίδρασης, που σταδιακά μετετράπη σε ένα πρόταγμα διακυβέρνησης.*

### **Αντί επιλόγου**

Τα κόμματα της πρώτης περιόδου φαίνεται να δομούν τον προεκλογικό λόγο τους βάσει της τοποθέτησης τους στον άξονα Αριστερά/Δεξιά. Έτσι, θέτουν τα θεμέλια της ιδεολογίας που αυτά εκπροσωπούν και στοχεύουν σε αντίστοιχη μερίδα εκλογέων. Την ίδια περίοδο τα κόμματα παρουσιάζουν σύγκλιση στις θέσεις τους καθώς κύριο διακύβευμα αποτελεί ο εκδημοκρατισμός μέχρι και το 1990. Αντίστοιχα απαντούν και στο αίτημα του εκσυγχρονισμού-εξευρωπαϊσμού από το 1993 μέχρι και το 2009. Φτάνοντας στο νέο πλαίσιο μνημόνιο-αντιμνημόνιο βλέπουμε πως πέραν του ΚΚΕ τα υπόλοιπα τελικά προχώρησαν στη διαμόρφωση των θέσεων τους βάσει αυτού του διπόλου.

Από τη σκοπιά της σύγκρισης των κομμάτων μεμονωμένα, το ΠΑΣΟΚ φαίνεται να μετεξελίσσεται εγκαίρως, κυρίως μετά το 1985 προκειμένου να απαντήσει στις κοινωνικές επιταγές κινούμενο πλέον προς το κέντρο. Ο λόγος του αλλάζει συχνά, συμπεριλαμβάνοντας νέα θέματα που ανταποκρίνονται στην εκάστοτε εποχή.

<sup>41</sup> Εκλογική διακήρυξη ΣΥΡΙΖΑ 2009 «ΣΥΡΙΖΑ ισχυρός στη Βουλή και στους αγώνες».

<sup>42</sup> Προεκλογικό πρόγραμμα ΣΥΡΙΖΑ 2012 «Κάνουμε τα μνημόνια παρελθόν, ανοίγουμε δρόμο στην ελπίδα»

<sup>43</sup> Προεκλογικό Πρόγραμμα «Η Ελπίδα έρχεται» Κυβερνητικό πλαίσιο και κυβερνητικό πρόγραμμα (2015)

Αντίστοιχα, η ΝΔ φαίνεται να κινείται παλινδρομικά καθόλη τη διάρκεια της πορείας της προς το κέντρο και Δεξιά. Αυτό μπορεί να δικαιολογηθεί πέραν των εκλογικών κινήτρων και από τη φυσιογνωμία των ηγετών της. Το ΚΚΕ διατηρεί τις ίδιες θέσεις καθόλη τη διάρκεια της πολιτικής του παρουσίας, τις οποίες ενισχύει ανάλογα με το διακύβευμα της εποχής. Ο ΣΥΡΙΖΑ φαίνεται να αλλάζει άρδην το πολιτικό του προφίλ από το 2015 και έπειτα, αναγκασμένος να προσαρμοστεί στα νέα δεδομένα που έχουν διαμορφωθεί. Το ίδιο φυσικά συνέβη και στα υπόλοιπα κόμματα που έπρεπε πλέον να δομήσουν το προεκλογικό τους πρόγραμμα βάσει του νέου αυτού πλαισίου.

Έτσι, παρατηρούμε πως ενώ τα κόμματα από τη συγκρότησή τους, τοποθετούνται στον άξονα προκειμένου να επικοινωνήσουν τις θέσεις τους και να προσελκύσουν την αντίστοιχη ιδεολογική ψήφο των εκλογέων, σταδιακά παρατηρείται πως οι εκλογείς ,σε κρίσιμες φάσεις της πολιτικής ιστορίας(όπως πχ. εκλογές 1989 και 2012), απομακρύνονται από την ψήφο βάσει ιδεολογικών κριτηρίων και υιοθετούν την τιμωρητική ψήφο ή ψήφο δυσαρέσκειας. Έτσι, είτε ψηφίζουν το αντιπολιτευόμενο κόμμα, ή κόμματα που εμφανίζονται ως απάντηση στο υπάρχον διακύβευμα της περιόδου (πχ. Πολιτική Άνοιξη, Ανεξάρτητοι Έλληνες κ.ά) και άλλα κόμματα, τα οποία ωστόσο αποτελούν θνησιγενή κόμματα που δημιουργούνται από τη μήτρα μεγαλύτερων κομμάτων όταν διαχωρίζονται οι θέσεις τους. Σε κάθε περίπτωση, αξίζει να σημειωθεί η προσαρμοστικότητα των κομμάτων στις επιταγές κάθε εποχής. Για παράδειγμα το ΠΑΣΟΚ , υπό τα νέα δεδομένα του 2012 και έπειτα, παρατηρούμε ότι παρότι συρρίκνωσε δραματικά τα ποσοστά του, διατήρησε ωστόσο την παρουσία του στο κοινοβούλιο. Αντίστοιχα, οι παλινδρομες κινήσεις της ΝΔ στον άξονα, τόσο λόγω συμμόρφωσης στις κοινωνικές ανάγκες όσο και λόγω προσωπικών επιλογών του εκάστοτε ηγέτη της υποδηλώνουν την επίσης έντονη προσαρμοστικότητά της. Η πτώση του δικομματισμού όπως ήταν γνωστός μέχρι λίγα χρόνια πριν και η ανάδειξη ενός νέου κόμματος ως δεύτερου πόλου πλέον, φαίνεται να δημιουργεί νέα δεδομένα στο πολιτικό σύστημα της Ελλάδας. Είναι προφανές ότι διανύουμε μια περίοδο διαμόρφωσης νέων πολιτικών συσχετίσεων και σίγουρα ανοίγει μια περίοδος που οφείλει να αναλυθεί σε σχέση με τις επερχόμενες, εφόσον αυτή όντως αποτελέσει τη μετά μνημόνιο εποχή.

## Βιβλιογραφία

- Βερναδάκης, Χρ. (2004). Η ίδρυση, η εξέλιξη και η μετεξέλιξη του ΠΑΣΟΚ: από το «κόμμα μαζών» στο «κόμμα του κράτους». Στο: Γ. Κοντογιώργης κ.α. (επιμ.), *Τριάντα χρόνια Δημοκρατίας: Το πολιτικό Σύστημα της Ελληνικής Δημοκρατίας, 1974-2004*. Αθήνα: Κριτική.
- Κοτζιάς, Ν., (1986). *Ο Τρίτος Δρόμος του ΠΑΣΟΚ, Κριτική με βάση τη Μαρξιστική-Λενινιστική Ανάλυση της ελληνικής πραγματικότητας* (ε' έκδ.), Αθήνα: Σύγχρονη Εποχή.
- Lyritzis, Chr. (2005). The changing party system: Stable democracy, contested. *West European Politics*, 28 (2): 242-259.
- Σπανού, Κ. (1998). ΠΑΣΟΚ και δημόσια διοίκηση: Η δύσκολη μαθητεία. Στο: Μ. Σπουρδαλάκης (επιμ.), *ΠΑΣΟΚ: Κόμμα-Κράτος-Κοινωνία*, Αθήνα: Πατάκης.
- Παππάς, Τ. (2001). Κομματικό σύστημα και πολιτικός Ανταγωνισμός στην Ελλάδα, 1981-2001, *Ελληνική Επιθεώρηση Πολιτικής Επιστήμης*, 17: 72-102.



### 13.3. Public governance and the management of wicked public problems

*Maria Rammata<sup>1</sup>*

#### Abstract

Wicked problems are increasing in Intensity and frequency attracting more and more the interest of national and international public governance, causing embarrassment or even impasse to Governments. This paper presents a detailed overview of the dimensions of “wicked” problems, their position in modern governance and the possible scenarios of managing them. The following practices are proposed so as to tame wicked problems : a) The authoritarian, competitive and collaborative process, b) The small wins (Incrementalism), c) the three phases of approach: Recognition, Development, Selection, and 4) Collaborative and Network Governance. The above mentioned practices attempt to develop the ability to manage these problems smoothly so as not to harm the political-administrative system.

**Key words:** governance, wicked problems, small wins – incrementalism, collaborative governance, stakeholders

#### Δημόσια διακυβέρνηση και διαχείριση των «νοσηρών» (wicked) προβλημάτων

*Μαρία Ραμματά*

#### Περίληψη

Τα νοσηρά (wicked) προβλήματα αυξάνονται σε ένταση και σε συχνότητα εμφάνισης απασχολώντας όλο και περισσότερο την εθνική και διεθνή δημόσια διακυβέρνηση, προκαλώντας αμηχανία ή και αδιέξοδα στις Κυβερνήσεις. Στο παρόν κείμενο γίνεται αναλυτική παρουσίαση των διαστάσεων των νοσηρών προβλημάτων, της θέσης που κατέχουν στο πλαίσιο της σύγχρονης διακυβέρνησης και των πιθανών σεναρίων αντιμετώπισής τους. Αναλυτικά επεξηγούνται ως μέσα διαχείρισής τους : α) Η αυταρχική, ανταγωνιστική και συνεργατική διαδικασία, β) οι Μικρές Νίκες – Σταδιακή προσέγγιση (Incrementalism), γ) Οι τρεις φάσεις προσέγγισης : Αναγνώριση, Ανάπτυξη, Επιλογή, και 4) η Συνεργατική - Δικτυακή διακυβέρνηση. Με τις παραπάνω αναλυόμενες πρακτικές επιχειρείται να δοθεί μία ανάπτυξη της δυνατότητας ομαλής διαχείρισης των προβλημάτων αυτών ώστε να μην πλήττεται η ευμάρεια του πολιτικοδιοικητικού συστήματος.

**Λέξεις κλειδιά:** διακυβέρνηση, νοσηρά προβλήματα, μικρές νίκες, συνεργατική διακυβέρνηση, ενδιαφερόμενα μέρη

#### Εισαγωγή

Στην παγκόσμια βιβλιογραφία έχει εισαχθεί ο όρος «wicked problems» - «νοσηρά» προβλήματα το 1973 από τους Rittel και Webber<sup>2</sup> όταν υπογραμμίστηκε η ανάγκη για ενασχόληση της δημόσιας διοίκησης με τόσο πολυσύνθετα προβλήματα ώστε να μπορούμε να μιλούμε μόνο για καλύτερη διαχείρισή τους, παρά για οριστική «δάμασή» τους (Wildavsky, 1979). Λέγεται μάλιστα ότι πολλές κυβερνήσεις που υποσχέθηκαν στην

<sup>1</sup> Phd in Administrative Sciences, University of Sorbonne Paris I, Lecturer University of Macedonia, Hellenic Open University. Email: m.rammata@gmail.com

<sup>2</sup> Αλλά και από το 1967 σε ένα άρθρο-editorial ο Churchman αναφέρθηκε στον Rittel και στα «αδάμαστα» προβλήματα τα οποία ο ίδιος είχε ήδη εισάγει στο δημόσιο διάλογο σε ένα σεμινάριο.

κοινωνία την επίλυση των «νοσηρών» προβλημάτων απλά μείωσαν την εμπιστοσύνη των πολιτών τους σε αυτές! Δηλωτική της ασάφειας και της πολυπλοκότητας των «νοσηρών» προβλημάτων είναι και η άποψη ότι είναι πιο απλό να εκτοξεύσει η NASA στο διάστημα έναν πύραυλο παρά να επιλυθεί ένα «νοσηρό» πρόβλημα όπως το μεταναστευτικό ή η παγκόσμια κλιματική αλλαγή!

Αλλά τι είναι πραγματικά ένα «wicked problem» και ποιες είναι οι προϋποθέσεις που πρέπει να πληροί για να το ορίσουμε ως τέτοιο; Οι Rittel and Webber (1973) πολεοδομικοί-αστικοί σχεδιαστές ανέπτυξαν αυτή την έννοια για να περιγράψουν εκείνα τα προβλήματα που εντάσσονται στις κοινωνικές επιστήμες των οποίων η επίλυση είναι ένα δύσκολο εγχείρημα, σε αντιδιαστολή με αυτά που κατατάσσονται στον τομέα φυσικών επιστημών και μπορούν να έχουν μία πιο άμεσα ορατή, προβλέψιμη και υπολογίσιμη λύση. Τα «νοσηρά» προβλήματα δεν μπορούν να προσδιοριστούν απόλυτα, ούτε να γίνουν κατανοητά υπό μία γραμμική συσχέτιση αιτίας-συμπτώματος-επίδρασης στις σχέσεις, εμπεριέχουν την ασάφεια και τη μη προβλεψιμότητα στην εξέλιξή τους, ενώ επισύρουν διαμάχες μεταξύ των ενδιαφερομένων μερών ως προς τις αξίες τις οποίες υπηρετούν το καθένα (value conflict). Αρχικά, η ανάλυσή των Rittel and Webber επικεντρωνόταν στα προβλήματα της φτώχειας, της πολεοδομικής ανασυγκρότησης, του ελέγχου του εγκλήματος και της φτώχης παιδείας. Όμως, μερικές δεκαετίες αργότερα, η μόλυνση του περιβάλλοντος και άλλα προβλήματα όπως, η αντεγκληματική πολιτική, η παραβατική συμπεριφορά των ανηλίκων, η υγεία, η διαχείριση της γης, η γεωργία, τα τρόφιμα, το νερό, τα ναρκωτικά, τα δάση και το κλίμα, διεύρυναν τον κύκλο των «νοσηρών» προβλημάτων για να συμπεριλάβουν και τα «περιβαλλοντικά», «οικολογικά» και «τεχνολογικής» φύσης προβλήματα (Conklin, 2006).

Τα περισσότερα «νοσηρά» προβλήματα είναι χρόνια και δηλωτικά της αποτυχίας των αντίστοιχων δημόσιων πολιτικών να υλοποιήσουν τον σχεδιασμένο στόχο τους. Συχνές πρώιμες λύσεις των προβλημάτων αυτών καταλήγουν να είναι αυτές οι ίδιες τα μελλοντικά «νοσηρά» προβλήματα. Όπως για παράδειγμα, τόσο η άναρχη διεύρυνση της Γ΄ βάθμιας εκπαίδευσης στο σύνολό της, σε μη τεκμηριωμένα επαρκώς Τμήματα των ΑΕΙ ή μαθήματα Τμημάτων των ΑΕΙ, όσο και η περαιτέρω χωρική διασπορά τους σε Τμήματα-Παραρτήματα των ΤΕΙ ανά την χώρα κατήργησε την απαιτούμενη από τον Ν. 1404/1983 συμπληρωματικότητα Πανεπιστημίων και ΤΕΙ που με τη σειρά της οδήγησε σε αλληλοεπικάλυψη των γνωστικών αντικειμένων και σε σύγχυση μεταξύ των αποφοίτων σχετικά με τα επαγγελματικά τους δικαιώματα (Αιτιολογική έκθεση του Ν. 4589, ΦΕΚ 13 Α΄ 29/01/2019, «Συνέργειες Εθνικού και Καποδιστριακού Πανεπιστημίου Αθηνών, Γεωπονικού Πανεπιστημίου Αθηνών, Πανεπιστημίου Θεσσαλίας με τα Τ.Ε.Ι. Θεσσαλίας και Στερεάς Ελλάδας, Παλλημνιακό Ταμείο και άλλες διατάξεις», σελ. 1-2, και Χρυσομαλλίδης, 2017). Η παραπάνω κατάσταση οδήγησε στη σημερινή απορρόφηση των ΤΕΙ από τα συναφή ΑΕΙ, κληροδοτώντας έτσι, νέα «νοσηρά» προβλήματα στην σημερινή ηγεσία του Υπ. Παιδείας και Θρησκευμάτων και στην Πανεπιστημιακή Κοινότητα, όσο και στην τοπική οικονομική ανάπτυξη της επαρχίας που είχε συνδυαστεί με την παρουσία συγκεκριμένων Τεχνολογικών Ιδρυμάτων. Όμως, η διαχείριση της Τριτοβάθμιας εκπαίδευσης είναι πολύ πιο σύνθετη, βαθιά και απαιτητική από την απλή μαθηματική λογική της εξοικονόμησης πόρων και της μεταφοράς

των κονδυλίων από τα ΤΕΙ στα ΑΕΙ με τα οποία και συγχωνεύονται με τεράστιες επιπτώσεις στις ανάγκες για αποφοίτους από αμιγώς τεχνολογικές Σχολές, αλλά και στα συναφή επαγγελματικά δικαιώματα. Αντίστοιχη μετακύλιση ενός «νοσηρού» προβλήματος στις επόμενες γενεές, ιδιαίτερα μετά τη δεκαετία του 1950, αποτελεί και η άναρχη ανοικοδόμηση του κέντρου της Αθήνας που δόθηκε ως απάντηση στο επείγον ζήτημα της απίσχανσης της επαρχίας και της αστυφιλίας, η οποία όμως αλλοίωσε την πολιτιστική φυσιογνωμία της πρωτεύουσας και κληροδότησε νέα χωροταξικά προβλήματα στην σύγχρονη πόλη. Το παραπάνω φαινόμενο, σε συνδυασμό με τον εγκιβωτισμό άνω των 500 χλμ. χειμάρρων και ρυακίων από τον 19<sup>ο</sup> αιώνα και έπειτα, όξυνε ακόμη περισσότερο την υποβάθμιση του φυσικού περιβάλλοντος και του κάλλους του κέντρου της πρωτεύουσας, οδήγησε σε αύξηση της θερμοκρασίας περιβάλλοντος και στη διαμόρφωση μίας μη φιλικής πόλεως για τους κατοίκους και τους επισκέπτες της.

Ένα επιπλέον χαρακτηριστικό των σύγχρονων αυτών προβλημάτων είναι ότι εντάσσονται στην ευρύτερη έννοια της διαχείρισης των συστημικών προβλημάτων, όπου οι επιρροές είναι πολλαπλές, τόσο εντός του συστήματος, όσο και έξω από αυτό και για τα οποία μία μεθοδολογική κεντρική προσέγγιση δεν μπορεί να επιφέρει τις προσδοκώμενες λύσεις. Την αρμοδιότητα για την επίλυση των προβλημάτων αυτών μοιράζονται συνήθως πολλές δημόσιες υπηρεσίες, ενώ οι επιπτώσεις των προβλημάτων είναι συχνά απρόβλεπτες και μη επιθυμητές (Cortrell & Peterson, 2001) διότι συστημικές αλλαγές μεταξύ των αλληλοσυνδεόμενων παραγόντων σε διάφορους τομείς (περιβάλλον, κουλτούρα, τεχνολογία, κ.ά.), καθώς και σε υποτομείς, έχουν πολυσύνθετες επιπτώσεις σε άλλα μέρη του συστήματος. Για παράδειγμα, μία αλλαγή στο σύστημα διατροφής και στον αγροτικό υποτομέα μπορεί να έχει δραματικές αλλαγές σε άλλους υποτομείς, όπως στην ενέργεια, την υγεία, την οικονομία, αλλά και την εκπαίδευση.

Στην πλειοψηφία τους τα «νοσηρά» προβλήματα συνδέονται με την ανθρώπινη συμπεριφορά και προκαλούν παράπλευρες συνέπειες (στην οικονομία, στις πολιτικές, στην παραγωγικότητα, στην κοινωνία), όπως για παράδειγμα, η δημόσια υγεία ή η διαχείριση των χρόνιων παθήσεων, όπως ο διαβήτης και η παχυσαρκία, όπου οποιαδήποτε άσκηση ρυθμιστικής πολιτικής θα επιφέρει επιπτώσεις στην οικονομία, στην έρευνα, στην παιδεία και στην κοινωνία. Επίσης, άλλα «νοσηρά» προβλήματα μπορεί να αποτελέσουν την αφορμή για το συντονισμό της δράσης των δημοσίων διοικήσεων σε περιφερειακό ή σε διεθνές επίπεδο (Χρυσανθάκης, 2015), όπως η κλιματική αλλαγή, έναν τομέα στον οποίο αποδείχθηκε ότι η επιτυχία των πολιτικών (όπως η μείωση του θείου) που σχεδιάζονται για την μείωση της ατμοσφαιρικής ρύπανσης στην Αμερική και στη Δυτική Ευρώπη είναι, μερικώς, υπεύθυνες για την αύξηση της παγκόσμιας υπερθέρμανσης λόγω της μείωσης των σωματιδίων του θείου στην ατμόσφαιρα που, υπό κανονικές συνθήκες, σχηματίζουν σύννεφα και παγιδεύουν την θερμότητα στην ατμόσφαιρα (Swedish Environmental Protection Agency).

### **Επίλυση και διαχείριση των κακότροπων προβλημάτων**

Ορισμένες πρακτικές για την καλύτερη διοίκηση των προβλημάτων αυτών που έχουν αναδειχθεί και κατά τη διεθνή βιβλιογραφική επισκόπηση αλλά και από εμπειρικές μελέτες είναι :

1) Αυταρχική, ανταγωνιστική και συνεργατική διαδικασία.

- 2) Μικρές Νίκες – Σταδιακή προσέγγιση (Incrementalism).
- 3) Τρεις φάσεις προσέγγισης : Αναγνώριση, Ανάπτυξη, Επιλογή.
- 4) Συνεργατική - Δικτυακή διακυβέρνηση.

### 1) **Αυταρχική, ανταγωνιστική και συνεργατική διαδικασία**

Με βάση την ταξινόμηση των πιθανών διαχειριστικών μεθόδων για τα «νοσηρά» προβλήματα του Καθηγητή Roberts (2000) αυτές είναι τρεις : αυταρχική, ανταγωνιστική και συνεργατική. Κατά την **πρώτη διαδικασία**, η ευθύνη για την επίλυση των προβλημάτων εναποτίθεται σε μία ομάδα ή σε έναν ηγέτη που λόγω της γνώσης και της εξειδίκευσης που αναγνωρισμένα κατέχουν ή της πολιτικής ευθύνης που αναλαμβάνουν μπορεί να αποφασίσουν αρμοδίως για την έκβαση του προβλήματος. Για παράδειγμα, μπορεί να είναι ένα ανώτατο Δικαστήριο ή μία κεντρική Τράπεζα για θέματα επιτοκίων ή ένας ανώτατος αξιωματούχος. Στα θετικά αυτής της διαδικασίας συγκαταλέγεται η αμεσότητα και η αποτελεσματικότητα, ενώ στα αρνητικά η αποξένωση της διαδικασίας από την κοινότητα των πολιτών.

Με βάση την **δεύτερη** προτεινόμενη **διαδικασία** επίλυσης των «νοσηρών» προβλημάτων, κεφαλαιώδους σημασίας αναδεικνύεται η αποκάλυψη *όλων* των ανταγωνιστικών δυνάμεων διά μέσου των - άμεσα και έμμεσα - ενδιαφερομένων μερών και ειδικότερα, η αναζήτηση του μεριδίου της εξουσίας, της επιρροής και της αγοράς που θα επικρατήσει σε κάθε περίπτωση και, άρα, η αναγνώριση της ύπαρξης *νικητών* και *ηττημένων* για το επίμαχο προς επίλυση θέμα. Στα θετικά αυτής της διαδικασίας συγκαταλέγεται η ανάδειξη *όλων* των πλευρών του ζητήματος, ενώ στα αρνητικά, η πιθανότατη διένεξη μεταξύ των ενδιαφερομένων που μπορεί να φτάσει και σε αδιέξοδο.

Με βάση την **τρίτη διαδικασία** η οποία προτείνεται για την διαχείριση των «νοσηρών» προβλημάτων, προτάσσεται η συνεργατική προσέγγιση κατά την οποία εισακούονται όλες οι φωνές, σε μία προοπτική κερδίζω-κερδίζεις (win-win). Εδώ, είναι λιγότερο πιθανή η κατάληξη σε αδιέξοδο ενώ οι συμπράξεις, οι κοινοπραξίες και η ολιστική προσέγγιση μέσα ακόμη και από διεθνείς συμφωνίες μπορεί να καταλήξουν σε διαχείριση και τελικά σε έλεγχο του θέματος.

### 2) **Μικρές νίκες - Σταδιακή προσέγγιση (Incrementalism)**

Ένας από τους κύριους κινδύνους κατά τη διαχείριση των κακότεροπων προβλημάτων είναι η αναζήτηση απαντήσεων μέσω της «υπερανάλυσης» που μπορεί να οδηγήσει σε «παράλυση» ή στην υπερεκτίμηση των δυνατοτήτων ενός φορέα ο οποίος μπορεί να μη διαθέτει και την ικανότητα ολοκλήρωσης της διαδικασίας επίλυσης του προβλήματος (έως την υλοποίηση, την αξιολόγηση και την ανατροφοδότηση). Η παράλυση εμφανίζεται όταν τα «νοσηρά» προβλήματα ορίζονται τόσο υπερβολικά ώστε τελικά να αποθαρρύνονται οι ειδικοί από την ουσιαστική επίλυσή τους και να οδηγούνται σε πλήρη αδράνεια (Levin et al. 2012, Roberts, 2000). Για την αποφυγή της αδράνειας έρχεται στο προσκήνιο η πρόταση της εκλογίκευσης και της σταδιακής προσέγγισης μερών του προβλήματος (sensemaking) που προτείνει ο τομέας των Κοινωνικών επιστημών (Weick, 1995), καθώς και η μελέτη για τη συνεχή αλλαγή που πρεσβεύει η οργανωσιακή επιστήμη και τη

σταδιακή προσέγγιση (incrementalism) κατά τις πολιτικές επιστήμες (Lindblom, 1959, 1979, Μακροδημήτρης & Πραβίτα, 2012). Επί παραδείγματι, για τη διαχείριση των αστέγων η διανομή πρωινού φαγητού αποτελεί μία «μικρή νίκη» αλλά δεν είναι μία οριστική επίλυση του ζητήματος ή ακόμη, για το εγχείρημα της μετεγκατάστασης των φυλακών Κορυδαλλού εκτός του αστικού ιστού, η μετεγκατάσταση μέρους των φυλακών (γυναικείες φυλακές) αποτελεί ένα μικρό βήμα προς την κατεύθυνση της επίλυσης του ζητήματος που δίδει χρόνο στους ιθύνοντες ώστε να σχεδιάσουν τις αμέσως επόμενες κινήσεις.

Οι «μικρές νίκες» ως μία από τις προτεινόμενες προσεγγίσεις επίλυσης έχουν τα παρακάτω θετικά στοιχεία (Termeer & Dewulf, 2019) :

- Αποκαλύπτουν άμεσα δείγματα αποτελεσμάτων των όσων μέχρι πρότινος είχαν την φήμη των θεωρητικών κατασκευασμάτων δίδοντας έτσι στο εκλεκτορικό Σώμα επιχειρήματα υπέρ της ρεαλιστικής διακυβέρνησης που δεν υπόσχεται μόνο, αλλά και πράττει.
- Δίδουν αισιοδοξία στους ειδικούς ότι μικρές πρόοδοι μπορεί να καταλήξουν σε βάθος χρόνου στην οριστική επίλυση του ζητήματος. Έως τότε, προετοιμάζουν το έδαφος για τις αμέσως επόμενες «μικρές νίκες».
- Τα άμεσα ορατά αποτελέσματα των «μικρών νικών» δίδουν την ευκαιρία για γνώση μέσα από την πράξη (learning by doing) εφόσον παρέχουν απευθείας ανατροφοδότηση ως προς την αποτελεσματικότητα της εφαρμοσμένης μεθόδου η οποία θα επαναχρησιμοποιηθεί εφ'όσον κριθεί επιτυχής ή θα βελτιωθεί.
- Οι μικρές παρεμβάσεις εκμηδενίζουν σχεδόν τις αντιδράσεις που θα προκαλούσε ένα μακροπρόθεσμο και μεγαλεπήβολο σχέδιο αλλαγής.
- Οι αλληπάλληλες, μικρής διάρκειας κυβερνητικές θητείες ευνοούν την αποσπασματική και μερική επίλυση των μεγάλων θεμάτων που σχετίζονται με τα δημόσια «νοσηρά» προβλήματα.
- Είναι περισσότερο άμεσα συνυφασμένες με την ευμεταβλητότητα και τον εφήμερο χαρακτήρα των εκάστοτε δεδομένων.

### 3) Τρεις φάσεις προσέγγισης : Αναγνώριση, Ανάπτυξη, Επιλογή.

Οι τρεις κυρίαρχες φάσεις του προβλήματος που αναπτύχθηκαν από τους Mintzberg, Raisinghani & Theoret (1976) είναι οι παρακάτω : αναγνώριση του προβλήματος, ανάπτυξη εναλλακτικών επιλογής διαχείρισής του, επιλογή βέλτιστης προτεινόμενης λύσης.

#### Αναγνώριση

Ένα από τα πιο κρίσιμα στάδια κατά την διαμόρφωση των δημόσιων πολιτικών που αποσκοπούν στο να απαντήσουν στα αιτήματα της κοινωνίας, αποτελεί η πλήρης και αντικειμενική οριοθέτηση του εκάστοτε προβλήματος λαμβάνοντας υπόψη όλες τις παραμέτρους που υπεισέρχονται κατά τον προσδιορισμό του. Ατελής ορισμός ενός προβλήματος μπορεί να οδηγήσει σε επίλυση του λάθος προβλήματος. Τα «νοσηρά»

προβλήματα λόγω της δυσκολίας επίτευξης συμφωνίας ως προς τον προσδιορισμό τους και λόγω των διαφορετικών εκφάνσεων και επιρροών που μπορεί να έχουν οι διαφορετικές όψεις τους, καταλήγουν να προβάλουν την επίλυση άλλων πτυχών του προβλήματος από αυτήν που κυρίαρχα μπορεί να επιθυμεί να επιλύσει η εκάστοτε Κυβέρνηση. Συνέπεια αυτού είναι να απογυμνώνουν την πολιτική ηγεσία από κάθε πολιτική ιδεολογία και να αποσπών, αναπόδραστα, μέρος της κυριαρχικής εξουσίας του Κράτους ενισχύοντας την άποψη για το αποκενωμένο (hollow out) κράτος (Milward, 1996, Milward & Provan, 2000, Ραμματά κ.ά., 2019).

### **Ανάπτυξη**

Σε ένα επόμενο στάδιο και εφόσον επέλθει η συλλογή των απαιτούμενων πληροφοριών σχετικά με το πρόβλημα και εκκινήσουν οι απαραίτητες διαβουλεύσεις με τα ενδιαφερόμενα μέρη αναδεικνύονται οι «αρχές και τα κριτήρια» (principles and criterias) με βάση τα οποία επιλέγεται το βέλτιστο σενάριο δράσης. Τα εναλλακτικά σενάρια δράσης αναπτύσσονται με ελευθερία σκέψης και κατά τη διαχείριση των προβλημάτων επιτρέπεται η εμπλοκή του μέγιστου αριθμού των ενδιαφερομένων μερών ώστε να εκφράζονται οι απόψεις τους για το επίμαχο θέμα.

### **Επιλογή**

Εκτιμάται η προτεινόμενη λύση και η οργάνωση δεσμεύεται σχετικά με την υλοποίησή της. Η διαδικασία αυτή σπάνια υλοποιείται ομαλά. Είναι ασταθής και έχει συχνές διακοπές. Ακόμη και όταν λαμβάνεται μία απόφαση μία νέα επιλογή μπορεί να αναφανεί και να οδηγήσει όλη τη διαδικασία από την αρχή.

#### **4) Συνεργατική – Δικτυακή διακυβέρνηση**

Στη μετάβαση από την γραφειοκρατική γραμμική οργάνωση του κράτους σε μία πιο «μαλακή» (soft) εκδοχή της γραφειοκρατίας (bureaucracy) (Speed, 2011), (Spanou & Sotiropoulos, 2011), τα «νοσηρά» προβλήματα επαναπροσδιορίζουν τη δημόσια δράση και αντιπροσωπεύουν το πέρασμα από μία στενή και κάθετη προοπτική, προς μία ευρεία, διευρυμένη και οριζόντια διαχείριση της απόδοσης των δημοσίων πολιτικών (Μακρυδημήτρης, 2013).

Πράγματι για την αντιμετώπιση των «νοσηρών» προβλημάτων, προτάσσεται η οριζόντια-συνεργατική διακυβέρνηση διότι :

- Τα στάδια επίλυσης του προβλήματος δεν είναι διακριτά, αλλά συνυφαίνονται συνήθως μεταξύ τους : ο καθορισμός του προβλήματος, για παράδειγμα, αναπτύσσεται ταυτόχρονα με τις πιθανές λύσεις ή τα εναλλακτικά σενάρια επίλυσής του ή ακόμη ο σχεδιασμός δεν διαφοροποιείται αισθητά από την εκτέλεση-αξιολόγηση-ανατροφοδότηση.

- Η διαδικασία διοίκησης των «νοσηρών» προβλημάτων εμπλέκει όλο και περισσότερους ενδιαφερόμενους φορείς οι οποίοι εφόσον απομονωθούν διαιωνίζουν το πρόβλημα.

- Τα διακυβεύματα είναι δυναμικά, έτσι μπορεί στην αρχική agenda να υπήρχε μία όψη του προβλήματος, αλλά στην πορεία με την συμμετοχή και περισσότερων ενδιαφερομένων μερών να προστίθενται και άλλες.

- Παρατηρείται απουσία διαπιστωμένης και αναγνωρισμένης ισχύος ενός μέρους ακόμη και του εκπροσώπου της δημόσιας διοίκησης που μπορεί να χάνει την εξουσιαστική του δύναμη του ενώπιον της βιομηχανίας ή των ισχυρών ενδιαφερομένων μερών (hollow out of the State).

- Οι Νέες Τεχνολογίες, Πληροφοριών και Επικοινωνίας (ΤΠΕ) ευνοούν την προώθηση λύσεων και την βέλτιστη ανταλλαγή απόψεων επί των «νοσηρών» θεμάτων.

Η διαχείριση των πολύπλοκων «νοσηρών» προβλημάτων απαιτεί την σύμπραξη κρατικών αξιωματούχων, αιρετών, Μη Κυβερνητικών Οργανώσεων (ΜΚΟ), εκπροσώπων του ιδιωτικού τομέα και της βιομηχανίας, καθώς και εκπροσώπων οργανώσεων των πολιτών, υπό μία συναινετική προοπτική που θα αποσκοπεί στην αναζήτηση της κοινής συνισταμένης. Στην προσπάθεια αντιμετώπισης των «νοσηρών» προβλημάτων η λογική διαφεύγει από την κάθετη και γραμμική προσέγγιση των ζητημάτων που ήταν μία αποτελεσματική μεθοδολογία διαμόρφωσης των δημόσιων πολιτικών κατά το ορθολογικό μοντέλο, λαμβάνει απόσταση από αυτά καθ'εαυτά τα συμφέροντα της εκάστοτε υπηρεσίας και επικεντρώνεται στις ανάγκες των χρηστών τις οποίες αναμοχλεύει μέσα από σειρά πολυμερών διαπραγματεύσεων που εστιάζουν στην πειθώ και τους αμοιβαίους συμβιβασμούς. Γιατί πράγματι, στη σύγχρονη διακυβέρνηση απαιτείται η διαβούλευση, η διαπραγμάτευση, η πειθώ και η ανταλλαγή απόψεων μέσα από δίκαιες και ανοικτές συνομιλίες με τα άμεσα και έμμεσα ενδιαφερόμενα μέρη (Majone, 1989). Και ενώ, η κεντρική άσκηση της εξουσίας και η ρυθμιστική διακυβέρνηση παραμένουν καίρια εργαλεία, γίνεται πλέον σαφές ότι, η σύνταξη ενός νομοθετήματος από ειδικούς εμπειρογνώμονες και τεχνικούς-νομικούς συμβούλους δεν αποτελεί πανάκεια για την επίλυση οποιουδήποτε δημόσιου προβλήματος.

Ένα ενδεικτικό παράδειγμα της ανάγκης για οριζόντια διαχείριση και συντονισμό των πολιτικών αποτελεί η διαχείριση των υδάτινων πόρων που σκοπεύει, τόσο στο να προμηθεύσει νερό επαρκούς ποσότητας και ποιότητας για την, κατά το δυνατόν, ικανοποίηση των οικιακών, αγροτικών, βιομηχανικών, ενεργειακών και άλλων αναγκών, για το παρόν και το μέλλον, όσο και να προστατεύσει τους υδατικούς πόρους από τη ρύπανση, να προσφέρει ασφάλεια για τους κατοίκους σε περιπτώσεις ακραίων υδρολογικών φαινομένων (πλημμύρες- ξηρασίες), να συντονιστεί με μία σειρά άλλους φορείς για την καλύτερη εφαρμογή των παραπάνω (Περιφέρεια, Δήμοι, Υπ. Αγροτικής Ανάπτυξης). Επιπλέον, η καλύτερη απόδοση στην θεματική περιοχή των υδάτων απαιτεί την σύμπραξη πολλών ειδικοτήτων όπως: υδρολόγοι, υδρογεωλόγοι, μηχανικοί, οικονομολόγοι, μετεωρολόγοι, κοινωνιολόγοι, αναπτυξιολόγοι, και των πολιτικών που πολλές φορές υπηρετούν υπερβολικά φιλόδοξα σχέδια. Για παράδειγμα, εάν οι πληροφορίες που σχετίζονται με ανάγκες σε νερό για υδρευτικούς σκοπούς τουριστικών εγκαταστάσεων δεν είναι έγκυρες ενδέχεται να πληγεί για ένα συγκεκριμένο χρονικό διάστημα μία τουριστική περιοχή. Ή ακόμη, ένα αναπτυξιακό σχέδιο σε σχέση με τις ανάγκες σε νερό για τη λειτουργία αρδευτικών έργων (εκτάσεις, είδη καλλιεργειών, είδη και λειτουργικά

στοιχεία αρδευτικών δικτύων) εφόσον δεν συντονιστεί σωστά με τις αντίστοιχες υπηρεσίες ενδέχεται, είτε να καθυστερήσει, είτε να αναδειχθούν αρνητικές επιπτώσεις κατά την εξέλιξή του.

Στο πέρασμα από την «Κυβέρνηση» στη «συνεργατική Διακυβέρνηση», από την απευθείας παροχή των δημόσιων υπηρεσιών στην εξ'αποστάσεως διακυβέρνηση και στη διαχείριση σύνθετων προβλημάτων, η Κυβέρνηση, τελικά, γίνεται ένας συντονιστής των πολυμερών διαπραγματεύσεων, της οποίας η αυθεντική εξουσία δεν πηγάζει από την κραταιά άποψη για το Κράτος και την εξουσία, αλλά από την ικανότητα διεξαγωγής δίκαιων διαπραγματεύσεων και άσκησης επιρροής προς την ικανοποίηση του βέλτιστου δημόσιου συμφέροντος μέσα από την πολυδιάστατη και πολυεπίπεδη διακυβέρνηση. Στο διαμορφωθέν αυτό πλαίσιο όπου η κρατική εξουσία αναλαμβάνει το ρόλο του διευκολυντή, ενισχύεται η εμπλοκή των ενδιαφερομένων μερών στην άσκηση εξουσίας (stakeholders), εκείνων δηλ. των ατόμων, ομάδων ή των οργανισμών που έχουν το συμφέρον και τη δυνατότητα να επηρεάσουν τις δράσεις και τους στόχους ενός έργου, μιας οργάνωσης ή της κατεύθυνσης μίας πολιτικής (Mason and Mitroff, 1981) οι οποίοι οργανώνονται σε συσπειρωμένες ομάδες διαμορφώνοντας συνενώσεις ενδιαφερομένων μερών (multi-stakeholders partnerships, MSPs). Ως τέτοιοι αναγνωρίζονται ο ιδιωτικός τομέας, οι ΜΚΟ, οι Ακαδημαϊκοί, οι πολιτικοί και άλλες ενώσεις. Το ενδιαφερόμενο μέρος (stakeholder) είναι δηλαδή μια οντότητα με δεδηλωμένο η αντιληπτό ενδιαφέρον για ένα ζήτημα πολιτικής (Bryson et al., 2011). Ένα μεγάλο εύρος προσεγγίσεων και εργαλείων χρησιμοποιούνται προκειμένου για: α) την αναγνώριση των stakeholders, β) τη διαφοροποίηση και την κατηγοριοποίησή τους, γ) τη διερεύνηση των σχέσεων μεταξύ των stakeholders (Reed, 2008). Η ουσιώδης συνεργασία της κεντρικής εξουσίας ή του συντονιστικού κέντρου με τους εμπλεκόμενους stakeholders πρέπει να επιδιώκεται και να λαμβάνει χώρα σε κάθε στάδιο της διαδικασίας διαμόρφωσης και εφαρμογής ενός έργου ή μιας απόφασης στο πλαίσιο μιας πολιτικής. Από την επικράτηση των εκάστοτε ενδιαφερομένων μερών θα εξαρτηθεί και η πρωταρχική αξία η οποία θα προωθηθεί και θα ανταγωνιστεί τις λοιπές αξίες των συμμετεχόντων.

Τελικά, η ολιστική διακυβέρνηση διά μέσω των δικτύων που αναπτύσσει και του κύριου ρόλου των ενδιαφερομένων φορέων αποστασιοποιείται από κάθε μορφή πολιτικής ιδεολογίας και ενδέχεται, στην πορεία της διαχείρισης των «νοσηρών» προβλημάτων, τα ενδιαφερόμενα μέρη ή οι μεγάλες βιομηχανίες να είναι αυτά/ές που θα καθοδηγούν τα στάδια επίλυσης του προβλήματος ή θα προσπαθούν να επηρεάζουν τους ενδιάμεσους παίκτες, επιτυγχάνοντας, τόσο τη μείωση του δημοκρατικού ελλείματος, όσο και την διασφάλιση ότι οι τελικές αποφάσεις θα υλοποιηθούν.

### **Μελέτη περίπτωσης : Η διαχείριση ενός διεθνούς «νοσηρού» προβλήματος - η παραγωγή του φοινικέλαιου**

Από το 2000 η έντονη διεθνής ζήτηση για το φοινικέλαιο αποτέλεσε την αφορμή για την έναρξη ενός παγκόσμιου διαλόγου σχετικά με την επέκταση της καλλιέργειας των φοινικόδεντρων κυρίως στη Νοτιοανατολική Ασία (Μαλαισία, Ινδονησία, Κουάλα Λουμπόρ) σε συνέχεια και της έντονης δημόσιας κατακραυγής, ειδικά στην Ευρώπη, σχετικά με την απουσία ρυθμιστικού πλαισίου γι'αυτά τα είδη καλλιέργειας. Τα ΜΜΕ και οι περιβαλλοντικές ΜΚΟ ξεκίνησαν έναν αγώνα κατά των πολυεθνικών και των



βιομηχανιών που εκμεταλλεύονται το φοινικέλαιο ως το πιο αποτελεσματικό έλαιο με κριτήριο τη μέγιστη δυνατότητα παραγωγής ανά εκτάριο γης. Το 2002 σε απάντηση στο ζήτημα αυτό η World Wildlife Fund (WWF) και η πολυεθνική Uniliver ξεκίνησαν ένα διάλογο υπό τη μορφή «στρογγυλών τραπεζιών για τη βιώσιμη καλλιέργεια του Φοινικέλαιου» («Roundtable on Sustainable Palm Oil» - RSPO) στο πλαίσιο των οποίων λάμβαναν χώρα επίσημες συζητήσεις με ενδιαφερόμενα μέρη για το θέμα αυτό. Μεταξύ των κύριων σημείων του διαλόγου εντοπίζεται και η διασύνδεση της αποψίλωσης των δασών με την αλματώδη επέκταση της καλλιέργειας φοινικόδεντρων (Dentoni et al., 2018). Στη δημόσια συζήτηση ενεπλάκησαν ακόμη, εταιρείες συμβούλων επιχειρήσεων και συγκεκριμένα η περιβαλλοντική συμβουλευτική εταιρεία «ProForest» η οποία επίσης υπέβαλε τεχνική έκθεση για να διερευνήσει περαιτέρω το ζήτημα. Αυτή η τεχνική έκθεση αποτέλεσε το αντικείμενο συζήτησης κατά τον πρώτο γύρο των διαπραγματεύσεων. Το έτος 2004 διαμορφώθηκε μία ομάδα εργασίας με τίτλο «Criteria Working Group» (CWG) με στόχο να αναλύσει και να αποφασίσει (μέχρι το έτος 2005) ως προς τις αρχές και τα κριτήρια που θα έπρεπε να διέπουν την βιώσιμη καλλιέργεια του φοινικέλαιου. Η ομάδα εργασίας CWG θα δούλευε συναινετικά και καμία απόφαση δεν θα λαμβάνονταν εάν ερχόταν σε σύγκρουση με την άποψη μίας ενδιαφερόμενης ομάδας. Διάφορες ΜΚΟ που ενεπλάκησαν εφοδίασαν τον διάλογο με ενημερωμένες έρευνες ως προς την καλλιέργεια του φοινικέλαιου διευρύνοντας ακόμη περισσότερο το εύρος των επιλογών και ενισχύοντας την τεχνική διάσταση των διαπραγματεύσεων. Η όλη διαδικασία υπέστη σφοδρή κριτική κυρίως λόγω της έλλειψης επαρκούς αντιπροσώπευσης των σχετικών φορέων πίεσης, ενώ κατά τη γνώμη των συμμετεχόντων, ορισμένοι, σκοπίμως είχαν αποκλεισθεί. Ως προς την υιοθέτηση των πρώτων πρακτικών στα οποία κατέληξε η ομάδα, αυτά παρουσιάστηκαν το έτος 2007 (με 2 έτη καθυστέρηση), ενώ παράλληλα στις συζητήσεις εμπλέκονταν και άλλοι συμμετέχοντες. Οι ενδιαφερόμενοι φορείς αφορούσαν : ΜΚΟ όπως Greenpeace, WWF, Oxfam, Οργανώσεις αυτόχθονων πληθυσμών, Ακαδημαϊκούς, πολυεθνικές εταιρείες π.χ. Uniliver, εκπρόσωποι Ολλανδικών βιομηχανιών, εταιρείες συμβούλων Proforest Consultancy Group, Αγροτικές και συνεταιριστικές Ενώσεις παραγωγών, εταιρείες πιστοποίησης της παραγωγής φοινικέλαιου, κ.ά..

Το χρονικό διάστημα μεταξύ 2006 έως 2009 η εφαρμοστέα μέθοδος των στρογγυλών τραπεζιών που προαναφέρθηκε (RSPO) στόχο είχε :

- 1) την ανάδειξη της βέλτιστης διαδικασίας πιστοποίησης της καλλιέργειας φοινικέλαιου ως ένα κριτήριο βιωσιμότητας και σεβασμού της βιοποικιλότητας και των απαιτήσεων των ντόπιων πληθυσμών.
- 2) την επιβεβαίωση των νέων τεχνολογιών κατά την διαδικασία υποστήριξης της πιστοποίησης.
- 3) την συμμετοχή οργανώσεων, όπως οι παραγωγοί και οι αγρότες οι οποίοι θα έπρεπε να αποδεχθούν την προτεινόμενη διαδικασία πιστοποίησης.
- 4) την ενημέρωση των καταναλωτών για τα τελευταία δεδομένα σχετικά με την καλλιέργεια του φοινικέλαιου και την ασφάλειά του.

Το έτος 2008 υιοθετήθηκε ένα σύστημα πιστοποίησης παρότι στην όλη διαδικασία συζητήσεων εντάχθηκαν και άλλα θέματα, όπως η διασύνδεση της καλλιέργειας του φοινικέλαιου με την καταπάτηση των ανθρωπίνων δικαιωμάτων και την εκμετάλλευση του ντόπιου πληθυσμού είτε κατά την αγορά γης (αγορά γης σε υπερβολικά χαμηλές τιμές) είτε κατά τις συνθήκες καλλιέργειας της γης, γεγονότα που ενίσχυαν την φτώχεια των περιοχών.

Μετά το 2010 στην ατζέντα εισήλθε ως κύριο θέμα η μείωση των εκπομπών των ρύπων του θερμοκηπίου (GHG-Greenhouse Gas emissions) από την παραγωγή του φοινικέλαιου θεματική την οποία εισήγαγε η Greenpeace μετά την έκδοση της έκθεσης “Cooking the Climate” που συνέδεε την εκπομπή ρύπων CO<sub>2</sub> με την αποψύλωση δασών και εκτάσεων γης στην Ινδονησία. Μερικές ΜΚΟ παρέμειναν ως προωθητές ιδεών και γνώσης για τις εταιρίες, ενώ ο ενημερωτικός ρόλος των καλλιεργητών, των συνεταιρισμών, και των Ακαδημαϊκών παρέμεινε περιορισμένος. Ο τρόπος με τον οποίο προσέγγισαν οι διαπραγματεύσεις την μείωση των GHG καταδεικνύει την υπέρτατη εξουσία που κατέχει η βιομηχανία κατά την όλη διοίκηση του προβλήματος σε σχέση με τους υπόλοιπους ενδιαφερόμενους φορείς.

Εν κατακλείδι, με βάση τα συμπεράσματα που συνάγονται από την μελέτη που δημοσιεύθηκε στο περιοδικό *Journal of Business Ethics* (Dentoni et al., 2018), καθίσταται σαφές ότι τα «νοσηρά» προβλήματα, όπως είναι η βιώσιμη καλλιέργεια του φοινικέλαιου, εμπεριέχουν πλειάδα από ακανθώδη θέματα, όπως είναι, η προστασία της βιοποικιλότητας, η επιδείνωση της φτώχειας, η προστασία της μικρής περιουσίας των τοπικών κοινοτήτων, η καταπάτηση ανθρωπίνων δικαιωμάτων, η εκπομπή ρύπων στην ατμόσφαιρα, κ.ά., για την προσέγγιση των οποίων η μέθοδος διαβούλευσης διά μέσου των στρογγυλών τραπεζιών αναδεικνύεται σε ένα πρόσφορο εργαλείο. Η εξέλιξη των θεμάτων αυτών ενεργοποιούσε κάθε φορά και άλλους ενδιαφερόμενους φορείς οι οποίοι πρόσβεναν διαφορετικές αξίες ο καθένας, ενώ η ασάφεια και η έλλειψη ολοκληρωμένης γνώσης πάνω στα επιμέρους θέματα αποτέλεσε έναν επιπλέον παράγοντα ενίσχυσης των συγκρούσεων και ενδεχομένως και των αδιεξόδων ως προς τους προτεινόμενους χειρισμούς. Σαφέστατα η διαπραγματευτική δύναμη των ενδιαφερομένων μερών που συμμετείχαν διαδραμάτισε εξαιρετικό ρόλο στην επίτευξη ή μη της οργανωσιακής αλλαγής, έτσι ενώ οι εταιρίες και οι ΜΚΟ που υπερασπίζονταν τα ανθρώπινα δικαιώματα επηρέασαν τις αποφάσεις και οδηγούσαν σε αλλαγές, οι εκπρόσωποι των τοπικών κοινοτήτων και των Ινδονησιών παραγωγών για παράδειγμα που επιζητούσαν το μοίρασμα του κόστους πιστοποίησης της παραγωγής φοινικέλαιου στα διάφορα στάδια της εφοδιαστικής αλυσίδας δεν κατάφεραν να οδηγήσουν σε σημαντικές οργανωσιακές ευνοϊκές γι' αυτούς αποφάσεις. Στην εμπειρική αυτή μελέτη επαληθεύθηκε η άποψη κατά την οποία οι θέσεις των ενδιαφερομένων μερών μπορούν να επηρεάσουν την κατεύθυνση των δημόσιων «νοσηρών» προβλημάτων εφόσον πληρούνται οι τρεις παρακάτω προϋποθέσεις : 1) τα ενδιαφερόμενα μέρη διαθέτουν ισχυρή διαπραγματευτική δύναμη, 2) τα ενδιαφερόμενα μέρη έχουν νόμιμα τεκμηριωμένες απαιτήσεις, 3) τα αιτήματα των ενδιαφερομένων μερών συνοδεύονται από την παράμετρο της χρονικής πίεσης (Dentoni et al. 2018).

## Βιβλιογραφικές Αναφορές

- Bevir, M., & Rhodes, W. (2010). *The State as Cultural Practice*. Oxford: Oxford University Press.
- Boltanski, L. & Chiapello, E. (2005). *The New Spirit of Capitalism*. London: Verso. Catrien.
- Bryson, M., Patton, Q., & Bowman, A. (2011). Working with evaluation stakeholders: A rationale, step-wise approach and toolkit. *Evaluation and Program Planning*, 34(1): 1–12.
- Churchman, W. (1967). Guest editorial: Wicked problems», *Management Science*, 14(4): B141–B142.
- Conklin, J. (2006). *Dialogue mapping: Building shared understanding of wicked problems*. Chichester: John Wiley.
- Cortrell, P., & Peterson, S. (2001). Limiting the unintended consequences of institutional change. *Comparative Political Studies*, 34: 768-799.
- Dentoni, D., Bitzer, V., Schouten, G. (2018). Harnessing wicked problems in Multi-stakeholder Partnerships. *Journal of Business Ethics*, 150: 333–356.
- Head, W., & Alford, J. (2015). Wicked problems: Implications for public policy and Management. *Administration and Society*, 47(6): 711–739.
- Klijin, H., & Koppenjan, J. (2015). *Governance networks in the public sector*. London: Routledge.
- Levin, K., Cashore, B., Bernstein, S., & Auld, G. (2012). Overcoming the tragedy of super wicked problems: Constraining our future selves to ameliorate global climate change», *Policy Science*, 45: 123–152.
- Lindblom, C. (1959). The science of muddling through. *Public Administration Review*, 19(2): 79–88.
- Lindblom, C. (1979). Still muddling, not yet through. *Public Administration Review*, 39(6): 517–526.
- Μακροδημήτρης, Α. (2013). *Προσεγγίσεις στη θεωρία των Οργανώσεων- Διοικητική Επιστήμη II*. Αθήνα: Εκδ. Σάκκουλα Α.Ε..
- Μακροδημήτρης, Α., & Πραβίτα, Μ.-Η. (2012). *Διοικητική Επιστήμη I: Δημόσια Διοίκηση - Στοιχεία διοικητικής οργάνωσης*. Αθήνα: Ε΄ Έκδοση, Εκδ. Σάκκουλα Α.Ε..
- Majone, G. (1989). *Evidence, argument and persuasion in the policy process*. New Haven: Yale University Press.
- Mason, R., & Mitroff, I. (1981). *Challenging strategic planning assumptions: Theory, cases and techniques*. New York, NY: Wiley.
- Milward, B. (1996). Symposium on the Hollow State: Capacity, Control, and Performance in Interorganizational Settings. *Journal of Public Administration Research and Theory*, 6(2): 193-196.
- Milward, B. & Provan, G. (2000). Governing the Hollow State. *Journal of Public Administration Research and Theory*, 10 (2): 359-380.
- Mintzberg, H., Raisinghani, D., & Theoret, A. (1976). The structure of unstructure decision processes. *Administrative Science Quarterly*, 21 (2): 246-275.
- Newman, J. (2001). *Modernizing Governance*. London: Sage.
- Peters, G. (2017). What is so wicked about wicked problems? A conceptual analysis and a research program. *Policy and Society*, 36 (3): 385-396.
- Ραμματά, Μ., Δρένος, Δ., Ζαχαράκη Κ., Θεοδοσοπούλου, Α., Κουλούσιου, Δ., (2019). Όψεις του σύγχρονου «Αποκενωμένου» Κράτους στην Ελληνική Δημόσια Διοίκηση: προβληματισμοί και προοπτικές. *Επιθεώρησης Δημοσίου Δικαίου και Διοικητικού Δικαίου*, 63 (4): 15.
- Ραμματά Μ. (2018). Μεταρρυθμιστικές απόπειρες στην ελληνική δημόσια διοίκηση. *Θεωρία και Πράξη Διοικητικού Δικαίου*, 8-9: 708-721.
- Reed, S. (2008). Stakeholder participation for environmental management: A literature review. *Biological Conservation*, 141(10): 2417–2431.
- Rhodes, W. (1997). From Marketisation to Diplomacy: It's the Mix that Matters. *Australian Journal of Public Administration*, 56 (2): 40–53.
- Rittel, H., & Webber, M. (1973). Dilemmas in a general theory of planning. *Policy Sciences*, 4 (2): 155–169.
- Roberts, N. (2000). Wicked problems and network approaches to resolution. *International Public Management Review*, 1: 1–16.
- Schön, D., & Rein, M. (1994). *Frame reflection: Toward the resolution of intractable policy controversies*. New York: Basic Books.
- Spanou, C., & Sotiropoulos, (2011). The odyssey of administrative reforms in Greece, 1981–2009: A tale of two reform paths. *Public Administration*, 89 (3): 723–737.
- Speed, E. (2011). *Applying Soft Bureaucracy to Rhetorics of Choice: The UK NHS, 1983–2007*. In: Clegg, S., Harris, M., and Hopfl, H. (eds.), *Managing Modernity: Beyond Bureaucracy?* Oxford: Oxford University Press, pp. 81–104.
- Sullivan, H., & Skelcher, C. (eds) (2002). *Working across Boundaries: Collaboration in Public Services*. Basingstoke: Palgrave Macmillan.

- Termeer C., & Dewulf A. (2019). A small wins framework to overcome the evaluation paradox of governing wicked problem. *Policy and Society*, 38(2): 298–314.
- Χρυσανθάκης, Χ., (2015). *Εισηγήσεις διοικητικού δικαίου*, 2<sup>η</sup> έκδοση. Αθήνα: Εκδ. Νομική Βιβλιοθήκη.
- Χρυσομαλλίδης, Χ. (2017). Θεσμοί και μεταρρυθμίσεις στην Ελλάδα: η περίπτωση του χώρου ανώτατης εκπαίδευσης και έρευνας. *Ελληνική Επιθεώρηση Πολιτικής Επιστήμης*, 40: 45-69.
- Weick, E. (1995). *Sensemaking in organizations*. London, UK: Sage.
- Weick, E., & Quinn, R. (1999). Organizational change and development. *Annual Review of Psychology*, 50: 361–386.
- Wildavsky, B. (1979). *Speaking truth to power: The art and craft of policy analysis*. Boston: Little, Brown & Co.

### 13.4. Digital Barometer for Public Org's and Agencies

*Dimitrios I. Panopoulos*

#### **Abstract**

International academic, public and private research organizations recognize a gradually increasing exponential process of digitization and automation of many forms, and functions of states and the labor market. Digital transformation is one of the four global trends along with globalization, demographic aging, and migration flows / free and global human resource mobility. A key sector, drastically changing along with the advent of digital and exponential technologies is the labor market. Its basic dimensions (labor force, business ecosystem, Social Insurance Organizations,, government agencies, third social sector, professional branches and professions, vocational training systems, imbalances between labor supply and demand, mismatches) of various types, etc, are rapidly reshaping and becoming increasingly complex and intercorrelated and thus pose enormous challenges for all developed and underdeveloped countries. Digitization has a huge impact on every job, as almost all of them have internal actions and stages that can be automated.

Scientific criteria for measuring the feasibility of automating a job include: proportion of repetitive actions within working time, degree of importance, complexity of a job, mental effort or the use of logical connections, etc. International research showcase differentiations in the degree of job loss (due to the different focus and weight of influence given to quantitative and qualitative terms of the effect of automation / digitization on jobs), however scientific views converge on the type of digital skills-professions required -branches-environments of the future.

While there is a series of surveys that study the phenomenon at international / European level, or at the micro-sample level of EU MS, with a different methodology each time, Greece does not have a structured, extensive, organized, quantitative and qualitative, time-consistent research methodology or tool that studies in depth the above effects of the digital transformation on the Public Organizations and Services of the country here is a lack of a scientific, research, digital tool that processes data from various sources and metadata, to lead in a reliable way to draw conclusions, strategic directions, realistic forecasts and proposals to the relevant entities. There is no permanent university, administrative / national database that will consolidate the above, data and metadata, from already existing Information Systems of the greek State such as the Diagnostic Mechanism of the Ministry of Labor, I.S ERGNI, I.S. ELSTAT, I.S. G.E.M.I., Market etc. Intelligence (LMI) and other data from commercial Chambers. The new reality, especially within pandemics, imposes "functional plasticity" of Public Organizations, a constant alternative of continous transformation and lifelong learning and change.

The Digital Adaptability / Digital Performance Barometer of Public Organizations and Bodies aims to cover all the shortcomings, the infamous integrated methodological environment of primary research (with the creation of a corresponding I.S. afterwards) and the creation of a common space for comparison / processing of all available administrative and scientific data.

**Keywords:** Digital Transformation, Digital Barometer, Adaptation / Digital Performance of Public Organizations.

## Βαρόμετρο Ψηφιακής Προσαρμοστικότητας Δημοσίων Οργανισμών και Φορέων και Ψηφιακό Μάνατζμεντ

Δημήτριος Ι. Πανόπουλος<sup>1</sup>

### Περίληψη

Το ψηφιακό βαρόμετρο (Βαρόμετρο Ψηφιακής Προσαρμοστικότητας Δημοσίων Οργανισμών και Φορέων της Κεντρικής Κυβέρνησης) με μια ματιά αποσκοπεί στην μέτρηση της ψηφιακής απόδοσης και των φορέων που ασκούν ψηφιακή διακυβέρνηση στη χώρα μας. Οι συνολικοί δείκτες της ψηφιακής απόδοσης και προσαρμοστικότητας θα προέλθουν από την ανάλυση, μελέτη και ακριβή μέτρηση των επιπτώσεων του Ψηφιακού Μετασχηματισμού στην Αγορά Εργασίας, στα επαγγέλματα, τους κλάδους, τις νέες δεξιότητες, στα τυπικά και άτυπα συστήματα επαγγελματικής κατάρτισης, προβλέψεις για τις «μετατοπίσεις» και μεταβολές των επαγγελμάτων και κλάδων της οικονομίας. Το ψηφιακό βαρόμετρο ευελπιστεί να αναδείξει και τη σημαντικότητα τη στρατηγικής διαχείρισης νέων, υπό ανασχηματισμό οργανωσιακών μοντέλων δημοσίων οργανισμών και τη στρατηγική μετάβασης στα νέα ψηφιακά Επιχειρησιακά Μοντέλα του Δημοσίου Τομέα (digital public governance agile/change management).

**Λέξεις Κλειδιά:** Ψηφιακός Μετασχηματισμός, Ψηφιακό Βαρόμετρο, Υιοθέτηση/Ψηφιακή Απόδοση σε Δημόσιους Οργανισμούς.

**A. Εισαγωγή: Σκοπιμότητα της εισήγησης: τι προσφέρει ως ψηφιακό εργαλείο αξιολόγησης της προσαρμοστικότητας και της απόδοσης των οργανισμών και των φορέων της Κεντρικής Κυβέρνησης στην ελληνική δημόσια διοίκηση και την ακαδημαϊκή κοινότητα. Πως μπορεί να συνδυαστεί και με ευρωπαϊκά ψηφιακά εργαλεία αξιολόγησης, διασφαλίζοντας συγκρισιμότητα.**

Σύμφωνα με όλους τους ακαδημαϊκούς, διεθνείς ερευνητικούς και διακρατικούς οργανισμούς είναι σε εξέλιξη μια σταδιακά αυξανόμενη εκθετική διαδικασία ψηφιοποίησης και αυτοματοποίησης πολλών μορφών, εκφάνσεων και λειτουργιών των διαφόρων κρατών. Η ψηφιοποίηση ή ψηφιακός μετασχηματισμός είναι πλέον μία από τις τέσσερις παγκόσμιες τάσεις μαζί με τη παγκοσμιοποίηση, τη δημογραφική γήρανση, και τις μεταναστευτικές ροές/ελεύθερη και παγκόσμια κινητικότητα του ανθρώπινου δυναμικού. Ένας από τους κύριους τομείς που έχουν μεταβληθεί δραστικά από την έλευση των ψηφιακών και εκθετικών τεχνολογιών **είναι η αγορά εργασίας**. Οι βασικές διαστάσεις της (εργατικό δυναμικό, επιχειρηματικό οικοσύστημα, φορείς κοινωνικών εταίρων, κρατικοί οργανισμοί, τρίτος κοινωνικός τομέας, επαγγελματικοί κλάδοι, επαγγέλματα, συστήματα επαγγελματικής εκπαίδευσης, ανισοροπίες μεταξύ προσφοράς και ζήτησης εργασίας, (mismatches) διαφόρων τύπων κλπ) αναδιαμορφώνονται ταχύτατα, γίνονται διαρκώς πιο σύνθετες και πολύπλοκες και μέρα με τη μέρα εγείρουν τεράστιες προκλήσεις για όλα τα κράτη ανεπτυγμένα και μη.

Θεωρείται βέβαιο ότι οι παγκόσμιες διαδικασίες της αυτοματοποίησης και της ψηφιοποίησης έχουν μεγάλο μέγεθος επιρροή σε κάθε θέση εργασίας, καθώς σχεδόν όλες έχουν εσωτερικές ενέργειες και στάδια που μπορούν να αυτοματοποιηθούν. Οι παρακάτω διεθνείς έρευνες προβλέπουν:

<sup>1</sup> Οικονομολόγος, αναλυτής δεδομένων Μηχανισμού Διάγνωσης της Αγοράς Εργασίας, Υπουργείο Εργασίας, Τεχνικός Εμπειρογνώμονας ΕΕ

α) Osborne & Frey's (2013/ ακραία πρόβλεψη): 47% θέσεων εργασίας στις ΗΠΑ θα χαθούν τα επόμενα χρόνια.

β) World Economic Forum 2016: απώλεια πάνω από 5 εκατ. θέσεων στις 15 πιο ανεπτυγμένες χώρες μέχρι το 2020.

γ) McKinsey Global Institute (πιο συγκρατημένη 2015): Οι ψηφιακές τεχνολογίες θα υποκαταστήσουν περίπου 140 εκατ. θέσεις πλήρους απασχόλησης και υψηλής εξειδίκευσης εργατών.

δ) I.L.O: απώλεια περίπου 140 εκατομμυρίων θέσεων εργασίας, αλλά μόνο στην Ασία.

ε) Research Agency Forrester (2016): οι ψηφιακές τεχνολογίες θα καλύψουν 16% του συνόλου των εργατών στις ΗΠΑ μέχρι το 2025. Νέοι τύποι θέσεων εργασίας μπορούν να δημιουργήσουν μέχρι 9% επί του συνόλου καινούργιες θέσεις και τελικά η απώλεια θα είναι 7%.

στ) The World Bank (2016): 57% απώλεια θέσεων εργασίας στις χώρες του ΟΟΣΑ τα επόμενα χρόνια.

ζ) ΟΟΣΑ 2018: Απώλεια περίπου 17% των συνολικών θέσεων εργασίας τα επόμενα 15- 20 χρόνια στις χώρες που εξετάζει.

Έχουν θεσπιστεί επιστημονικά κριτήρια μέτρησης της δυνατότητας αυτοματοποίησης μιας θέσης εργασίας. Πχ: η αναλογία επαναλαμβανόμενων ενεργειών στο πλαίσιο χρόνου εργασίας, ο βαθμός σημαντικότητάς των, η πολυπλοκότητα μιας εργασίας, η καταβολή πνευματικής προσπάθειας ή η χρήση λογικών συνδέσεων, ο βαθμός εμπλοκής κριτικής σκέψης και απόφασης, ο βαθμός εμπλοκής συναισθηματικών παραμέτρων στην ολοκλήρωση του έργου και στις ποσοτικές και ποιοτικές διαστάσεις του κλπ.

Παρά τη σχετική απόκλιση των διεθνών ερευνών στην επιστημονική βιβλιογραφία, ως προς τον ακριβή βαθμό του μεγέθους απώλειας των θέσεων εργασίας (λόγω της διαφορετικής εστίασης και βάρους επιρροής που δίνεται σε ποσοτικούς και ποιοτικούς όρους επίδρασης της αυτοματοποίησης/ψηφιοποίησης στις θέσεις εργασίας), **οι επιστημονικές απόψεις συγκλίνουν στον τύπο των ζητούμενων ψηφιακών δεξιοτήτων-επαγγελματιών-κλάδων-περιβαλλόντων του μέλλοντος.** Όσον αφορά την ανάπτυξη ψηφιακών δεξιοτήτων, προτείνονται διάφορες μεθοδολογίες.

Ενδεικτικά ο Van Deursen (2016) αναλύει 5 τύπους (βλέπε Van Deursen & Helsper, & Eynon, 2016): 1. Operational skills (being able to operate a computer), 2. Mobile skills (being able to use a mobile device), 3. Information navigation skills (being able to find and interpret relevant information), 4. Social skills (sharing information and curating friendships), 5. Creative skills (creating online content).

Ενώ υπάρχει σειρά ερευνών που μελετούν το φαινόμενο σε διεθνές ή ευρωπαϊκό επίπεδο, ή σε επίπεδο μικρό-δείγματος των Κ-Μ της ΕΕ, με διαφορετική βέβαια κάθε φορά μεθοδολογία, **απουσιάζει από την χώρα μας δομημένη, εκτενής, οργανωμένη, ποσοτική και ποιοτική, χρονοσυνεχής έρευνα που να μελετά σε βάθος τις ανωτέρω επιπτώσεις του ψηφιακού μετασχηματισμού στους Δημόσιους Οργανισμούς και Υπηρεσίες της χώρας.** Δεν υπάρχει την ίδια στιγμή διεθνώς κατοχυρωμένο σύστημα δεικτών μέτρησης και απόδοσης των

δημοσίων οργανισμών και φορέων των χωρών, στο πεδίο της ψηφιακής προσαρμοστικότητας και των ψηφιακών δεξιοτήτων, επαγγελματών, εκπαιδευτικών μεθόδων, μετρήσεων ψηφιακής ικανοποίησης του πολίτη κλπ. **Ακολουθώς δεν υπάρχει ένα επιστημονικό, ερευνητικό, μεθοδολογικό ψηφιακό εργαλείο που να ενέχει πολύπλευρη επεξεργασία των δεδομένων διαφόρων πηγών και εισερχόμενων μεταδεδομένων, αλλά κυρίως να οδηγεί με ασφαλή και αξιόπιστο τρόπο στην εξαγωγή συμπερασμάτων και στρατηγικών κατευθύνσεων και ρεαλιστικών προβλέψεων και προτάσεων προς τους φορείς άσκησης πολιτικής.**

Επιπλέον απουσιάζει και κάποια διαρκής/μόνιμη, πανεπιστημιακή, διοικητική ή εθνική βάση δεδομένων ή Πληροφοριακό Σύστημα που θα συναξιοποιεί τα ανωτέρω, καθώς και σωρεία δεδομένων και στοιχείων, προερχόμενων από ήδη υπάρχοντα Πληροφοριακά Συστήματα της πολιτείας όπως ο Μηχανισμός Διάγνωσης Υπουργείου Εργασίας, ΠΣ ΕΡΓΑΝΗ, ΠΣ ΕΛΣΤΑΤ, ΠΣ ΓΕΜΗ, ΠΣ ΕΦΚΑ κλπ. Όλες αυτές οι πληροφορίες μαζί με τις θεματικές αλλά αποσπασματικές έρευνες του ιδιωτικού τομέα συγκροτούν το επονομαζόμενο Labour Market Intelligence (LMI) ή BI της αγοράς εργασίας.

Σε μακροοικονομικό επίπεδο, απουσιάζει ένα ενοποιημένο σχέδιο στρατηγικής διαχείρισης της ψηφιακής μετάβασης του Δημόσιου Τομέα στα νέα αποκεντρωμένα ψηφιακά επιχειρησιακά μοντέλα οριζόντιας συνεργασίας υπό το πνεύμα του one governance guidance που τόσο έντονα προτάσσει η ΕΕ μέσω των θεσμικών της οργάνων, στο πλαίσιο της εκθετικά αναπτυσσόμενης ψηφιακής οικονομίας.

Οι ελλείψεις αυτές επιφέρουν ανισοροπίες και δυσκαμψίες στη λειτουργία της αγοράς εργασίας, στην ελκυστικότητά της, στις προοπτικές υγιούς ανάπτυξής της, με ποικίλες αρνητικές επιπτώσεις. Αυτές οι επιπτώσεις απλώνονται στο ανθρώπινο δυναμικό, στη μη δυνατότητα δημιουργίας προηγμένου επιπέδου ψηφιακής εξπληρέτησης του πολίτη, στην ανικανότητα μείωσης του διοικητικού χρόνου εκτέλεσης συναλλαγών, την αδυναμία εστίασης στις ιδιαίτερες ηλεκτρονικές ανάγκες του κάθε ιδιώτη, στην αποστέρηση αλλαγής επιχειρησιακού μοντέλου λειτουργίας των Δημόσιων Οργανισμών και Φορέων, και κυρίως και σωρευτικά στην ελάχιστη μέχρι στιγμής ικανότητα εξαγωγής τεκμηριωμένων, data driven προτάσεων πολιτικής για την καρποφόρα εκμετάλλευση των τεράστιων ευκαιριών του φαινομένου του Ψηφιακού Μετασχηματισμού.

Ως εκ τούτου, έχει καταστεί επιτακτική η **εισαγωγή της ψηφιακής μέτρησης της προσαρμογής και απόδοσης των Δημοσίων Οργανισμών και Φορέων της Κεντρικής Κυβέρνησης (Ψηφιακή Διακυβέρνηση) στο ψηφιακό περιβάλλον**, η μόνιμη παρακολούθηση ενός ευρέως φάσματος πληροφοριών και στοιχείων, της σύγκρισης και επεξεργασίας των, της μόνιμης καταχώρισής αυτών σε ένα ενιαίο Πληροφοριακό Σύστημα που θα διαλειτουργεί με τα υπόλοιπα σχετικά εθνικά ΠΣ και που ως τελική εκροή για την πολιτεία θα παρέχει δομημένες, data driven προτάσεις πολιτικής, υλοποιήσιμες εντός εξαμήνου.

Θεμελιώδεις διαστάσεις αυτής της νέας πραγματικότητας είναι η «**λειτουργική πλαστικότητα**» των Δημόσιων οργανισμών, η δυνατότητα δηλαδή διαρκούς μετασχηματισμού και διαρκούς μάθησης και αλλαγής, (learning to learn, learning to change), η καλλιέργεια κουλτούρας συνεργασίας με φορείς κοινωνικών εταίρων, η



ανάπτυξη ψηφιακών συμπράξεων με επιχειρήσεις του Ιδιωτικού Τομέα, με εκπροσώπους της καινοτομίας και της δημιουργικότητας, του τρίτου κοινωνικού τομέα κλπ.

**Κυρίαρχος δομικός κοινός συντελεστής όλων των ανωτέρω και βάση εκκίνησης της ανάπτυξης του πλαισίου ψηφιακής παρακολούθησης και αξιολόγησης είναι οι ψηφιακές δεξιότητες, το πιο περιζήτητο γνωστικό πεδίο των επόμενων δεκαετιών.**

Η τεράστια τεχνολογική ανάπτυξη, σε συνδυασμό με το νέο παγκοσμιοποιημένο οικονομικό μοντέλο, δεν έχει έως τώρα θετικά αποτελέσματα, ως προς την αύξηση της απασχόλησης και της κοινωνικής συνοχής, καθώς δεν έχει εξασφαλισθεί η παράλληλη ανάπτυξη του ανθρώπινου δυναμικού. Στην τρέχουσα συγκυρία των άμεσων οικονομικών και τεχνολογικών αλλαγών, οι άνθρωποι μπορούν να ζήσουν πολλές μεταβατικές καταστάσεις στην προσωπική και ακαδημαϊκή τους ζωή, να αλλάξουν χώρα, να εναλλάξουν ή να συνδυάσουν δουλειά, μόρφωση, επιμόρφωση και εθελοντισμό. Για ανταποκριθούν στις συνεχείς μεταβολές, όλο και περισσότεροι άνθρωποι μαθαίνουν να αποκτούν νέες δεξιότητες και ικανότητες όχι μόνο στο παραδοσιακό πλαίσιο της σχολικής αίθουσας αλλά όλο και συχνότερα εκτός αυτής, ο καθένας δε με τον δικό του ρυθμό. Σήμερα οι ευκαιρίες μάθησης είναι απεριόριστες, δεν γνωρίζουν σύνορα και μπορούν να αξιοποιηθούν σε οποιοδήποτε χρόνο.

Η ευρωπαϊκή επιτροπή εντοπίζοντας το πρόβλημα διακήρυξε εγκαίρως, ότι απαιτείται άμεση προώθηση των δεξιοτήτων σε όλο το στελεχιακό δυναμικό «Προς μια ανάκαμψη με υψηλή απασχόληση» COM (2012). Στο πλαίσιο μάλιστα του στρατηγικού πλαισίου ευρωπαϊκής συνεργασίας στην εκπαίδευση και την κατάρτιση (ET 2020), η Επιτροπή τόνισε πόσο σημαντικό είναι να μπορούν οι εκπαιδευόμενοι να μαθαίνουν μέσω ανοικτών διαδικασιών, σε τυπικό ή μη τυπικό και άτυπο περιβάλλον μάθησης και να αξιοποιούν τις δεξιότητες και τα προσόντα, τα οποία απέκτησαν για τη βελτίωση της απασχόλησης και του επιπέδου ζωής τους (COM, 2012).

Η ανάπτυξη πρέπει να στοχεύει σε περαιτέρω βελτιώσεις όσον αφορά τόσο την παραγωγικότητα όσο και την απασχόληση, συμβάλλοντας σε μια αναβάθμιση και κατανομή των ανθρώπινων πόρων που να αντιστοιχεί στις οικονομικές και κοινωνικές ανάγκες, όπως τονίζεται στη στρατηγική «Ευρώπη 2020». Οι δυναμικές και χωρίς αποκλεισμούς αγορές εργασίας, στις οποίες τα άτομα διαθέτουν τα κατάλληλα προσόντα, έχουν πολύ μεγάλη σημασία για να ενισχυθεί η ανάπτυξη και ανταγωνιστικότητα της ευρωπαϊκής οικονομίας.

Η ανάπτυξη αντίστοιχα του δημόσιου τομέα και ο ψηφιακός μετασχηματισμός του προϋποθέτουν παράλληλη ανάπτυξη του ανθρώπινου δυναμικού του και ενίσχυση των ψηφιακών δεξιοτήτων του. Καθώς οι ΤΠΕ αναπτύσσονται ταχύτατα, οι ψηφιακές δεξιότητες στη διοίκηση καθίστανται όλο και πιο σημαντικές, απαραίτητες και απαιτούν συνεχή ενημέρωση και διαρκή βελτίωση. Επιπλέον, η ανάγκη ανάπτυξης και παροχής ηλεκτρονικών υπηρεσιών, προς τους πολίτες και τις επιχειρήσεις, αυξάνει την απαίτηση για στελέχη με δημιουργικότητα, καινοτομία και δεξιότητες υψηλότερου επιπέδου.

## Ορισμός Ψηφιακών Δεξιοτήτων

Οι ψηφιακές δεξιότητες αποτελούν ένα σύνολο γνώσεων (knowledge), δεξιοτήτων (skills) και στάσεων (behavior) που προσδίδουν στο χρήστη ψηφιακή ικανότητα (digital competence) με συγκεκριμένα αποτελέσματα.

Υπάρχει διαφοροποίηση στον τρόπο που ορίζεται η *ικανότητα* (competence) και η *δεξιότητα* (skill). Η έννοια της ικανότητας εμπεριέχει εκείνη της δεξιότητας, διότι όπως επιτρέπει στο άτομο να μπορεί να εφαρμόζει τις δεξιότητες και γνώσεις και σε πραγματικές συνθήκες, δηλαδή να έχει αποτελέσματα (Elkin, 1990).

Η ψηφιακή ικανότητα έχει ως στόχο την αποτελεσματική και κριτική χρήση των τεχνολογιών της Πληροφορίας/Πληροφορικής και της Επικοινωνίας, στη μάθηση, την εργασία, τη συμμετοχή στην κοινωνική ζωή, την ψυχαγωγία και την καθημερινή επικοινωνία περιλαμβάνοντας τα βασικά προσόντα που απαιτούνται για την υιοθέτηση των σχετικών τεχνολογιών. Υποστηρίζεται από τις βασικές δεξιότητες ΤΠΕ: χρήση Η/Υ για την ανάκτηση, την αξιολόγηση, την αποθήκευση, την παραγωγή, την παρουσίαση και την ανταλλαγή πληροφοριών καθώς και τις δεξιότητες επικοινωνίας και συμμετοχής σε δίκτυα συνεργασίας μέσω του Διαδικτύου. Περιλαμβάνουν επίσης την διαχείριση περιεχομένου και πληροφοριών καθώς και την επίλυση προβλημάτων στην καθημερινή ζωή. Οι ψηφιακές δεξιότητες είναι απαραίτητες γιατί παρέχουν τη δυνατότητα διαχείρισης μεγάλων ροών πληροφοριών και βοηθούν στην αντιμετώπιση πολυσύνθετων προβλημάτων.

Η ΕΕ στο εννοιολογικό μοντέλο αναφοράς για τις ψηφιακές δεξιότητες (DigComp 2.1-2017) αναλύει τις ψηφιακές δεξιότητες και ικανότητες με βάση δύο διαστάσεις: τη θεματική και το επίπεδο γνώσης. Στη θεματική διάσταση προσδιορίζονται **πέντε θεματικοί τομείς με 21 ικανότητες** και στο **επίπεδο γνώσης** προσδιορίζονται **τρία επίπεδα** χρηστών: **Βασικού, Έμπειρου και Ανεξάρτητου Χρήστη**.

## Θεματικοί Τομείς Ψηφιακών Δεξιοτήτων

- Πληροφοριών και Δεδομένων
- Επικοινωνίας και συνεργασίας
- Μέσων Εμνημέρωσης και ψηφιακού περιεχομένου
- Ασφάλεια και Θέματα Πνευματικών Δικαιωμάτων
- Κριτική σκέψη και επίλυση προβλημάτων

## Επίπεδα χρηστών Ψηφιακών Δεξιοτήτων

- Βασικός Χρήστης
- Ανεξάρτητος χρήστης
- Έμπειρος χρήστης

Σύμφωνα με την UNESCO οι ψηφιακές δεξιότητες ορίζονται ως "ένα εύρος δυνατοτήτων χρήσης ψηφιακών συσκευών, εφαρμογών επικοινωνίας και δικτύων για την πρόσβαση και τη διαχείριση πληροφοριών". Οι ψηφιακές δεξιότητες επομένως στόχο έχουν να επιτρέπουν στους ανθρώπους να αναζητούν πληροφορίες και δεδομένα, να δημιουργούν και μοιράζονται ψηφιακό περιεχόμενο, να επικοινωνούν και να συνεργάζονται στο ψηφιακό περιβάλλον και να λύνουν προβλήματα για αποτελεσματική και δημιουργική αυτοπεποίθηση στη ζωή, τη μάθηση, την εργασία και τις κοινωνικές δραστηριότητες γενικότερα. Οι ψηφιακές δεξιότητες, στοχεύουν επομένως στην αντιμετώπιση των ελλείψεων, των κενών και των αναντιστοιχιών όσον αφορά κυρίως τις δεξιότητες στον τομέα των ΤΠΕ, καθώς και την κάλυψη του συνεχιζόμενου ψηφιακού χάσματος με συνεχή ανάπτυξη νέων προηγμένων και καινοτόμων δεξιοτήτων για την εφαρμογή εργαλείων ΤΠΕ υψηλής ειδίκευσης (UNESCO, 2017).

Οι ψηφιακές δεξιότητες απαιτείται επίσης να διακριθούν (UNESCO, 2017) σε "Βασικές Ψηφιακές Δεξιότητες", "Προηγμένες Ψηφιακές Δεξιότητες" και "Καινοτόμες Ψηφιακές Δεξιότητες" οι οποίες προσδιορίζονται:

### **Βασικές Ψηφιακές Δεξιότητες**

Οι βασικές ψηφιακές δεξιότητες, δηλαδή οι λειτουργικές δεξιότητες που απαιτούνται για τη βασική χρήση των ψηφιακών συσκευών και των ηλεκτρονικών εφαρμογών, θεωρούνται κρίσιμη συνιστώσα, ενός νέου συνόλου δεξιοτήτων στην ψηφιακή εποχή, παράλληλα με τις παραδοσιακές δεξιότητες ανάγνωσης, γραφής και αριθμητικής. Οι βασικές ψηφιακές δεξιότητες έχουν μετακινηθεί από το «προαιρετικό» στο «κρίσιμο» επίπεδο και περιλαμβάνουν οριζόντιες «μαλακές δεξιότητες» όπως η ικανότητα αποτελεσματικής επικοινωνίας τόσο σε σύγχρονη σύνδεση όσο και σε ασύγχρονη σύνδεση σε ψηφιακά μέσα, η ικανότητα επίλυσης προβλημάτων εντός του ψηφιακού κόσμου και αναφέρονται ως «ψηφιακός αλφαριθμητισμός».

Σε πολιτικό επίπεδο η ΕΕ προωθεί τις ψηφιακές δεξιότητες μέσω πολλών δράσεων. Η Συμμαχία για τις ψηφιακές δεξιότητες είναι μια πρωτοβουλία της Ευρωπαϊκής Επιτροπής (2020) για την αντιμετώπιση του ψηφιακού αναλφαριθμητισμού και την αναβάθμιση των ψηφιακών δεξιοτήτων των Ευρωπαίων πολιτών, μέσα από συγκεκριμένες δράσεις.

Η Συμμαχία δεν περιορίζεται μόνο στα μέλη της, αλλά προωθεί τη σύμπραξη με φορείς του δημόσιου και του ιδιωτικού τομέα, εταιρείες του τομέα της πληροφορικής, ακαδημαϊκά και ερευνητικά ιδρύματα και κάθε άλλο ενδιαφερόμενο. Η δέσμευση των εταίρων στους στόχους της Συμμαχίας γίνεται μέσα από τις πρωτοβουλίες (pledges), οι οποίες αφορούν στη δέσμευση για την υλοποίηση δράσεων κατάρτισης, εκπαίδευσης και, γενικά, διάχυσης της γνώσης με αποδέκτες ένα ευρύ φάσμα ομάδων πολιτών, από εξειδικευμένους επαγγελματίες των ΤΠΕ μέχρι και βασικούς χρήστες.

Καθώς οι ψηφιακές δεξιότητες συνιστούν βασικό ζητούμενο της αγοράς εργασίας, η εξοικείωση με αυτές θα συμβάλλει σημαντικά στη μείωση της ανεργίας, στην ενίσχυση της ανταγωνιστικότητας και στην τόνωση της οικονομίας.

### **Διαστάσεις Βασικών Ψηφιακών Δεξιοτήτων**

Σύμφωνα με το Πλαίσιο Ψηφιακών Ικανοτήτων για τους πολίτες της ΕΕ (DigComp 2.0), στο εννοιολογικό μοντέλο αναφοράς προσδιορίζονται πέντε τομείς, ως βασικές διαστάσεις της ψηφιακής ικανότητας, οι οποίοι μπορούν να συνοψιστούν ως εξής:

#### **1) Αλφαριθμητικός πληροφόρησης και δεδομένων:**

- 1.1. Περιήγηση, αναζήτηση, φιλτράρισμα δεδομένων, πληροφοριών και ψηφιακού περιεχομένου.
- 1.2. Αξιολόγηση δεδομένων, πληροφοριών και ψηφιακού περιεχομένου. Δυνατότητα κρίσης της συνέπειας και αξιοπιστίας της πηγής και του περιεχομένου της.
- 1.3. Διαχείριση δεδομένων, πληροφοριών και ψηφιακού περιεχομένου. Οργάνωση, διαχείριση και αποθήκευση ψηφιακών δεδομένων, πληροφοριών και περιεχομένου.

#### **2) Επικοινωνία και συνεργασία:**

##### 2.1 Αλληλεπίδραση μέσω ψηφιακών τεχνολογιών

Αλληλεπίδραση μέσω ποικιλίας ψηφιακών τεχνολογιών και κατανόηση των κατάλληλων ψηφιακών μέσων επικοινωνίας σε συγκεκριμένο πλαίσιο

##### 2.2 Κοινή χρήση και διαμοιρασμός δεδομένων, πληροφοριών και ψηφιακού περιεχομένου μέσω ψηφιακών τεχνολογιών. Πρακτικές αναφοράς και απόδοσης δικαιωμάτων κατά την επαναχρησιμοποίηση.

##### 2.3 Συμμετοχή στην κοινωνία των πολιτών μέσω ψηφιακών τεχνολογιών

και χρήσης δημόσιων και ιδιωτικών ψηφιακών υπηρεσιών. Αναζητήσει

ευκαιριών για ενδυνάμωση και συμμετοχή στα κοινωνικά και δημόσια δίκτυα μέσω κατάλληλων ψηφιακών τεχνολογιών.

##### 2.4 Συνεργασία μέσω ψηφιακών τεχνολογιών για συνεργατικές διαδικασίες συν-κατασκευής και συν-δημιουργίας πόρων και γνώσεων.

##### 2.5 Κώδικας δεοντολογικής συμπεριφοράς στο διαδίκτυο

Τεχνογνωσία και πρότυπα συμπεριφοράς κατά τη χρήση ψηφιακών τεχνολογιών και αλληλεπίδραση σε ψηφιακά περιβάλλοντα. Προσαρμογή των στρατηγικών επικοινωνίας στο

συγκεκριμένο ακροατήριο και επίγνωση της πολιτιστικής και γενετικής πολυμορφίας σε ψηφιακά περιβάλλοντα.

### 2.6 Διαχείριση ψηφιακής ταυτότητας

Δημιουργία και διαχείριση μίας ή περισσότερων ψηφιακών ταυτοτήτων, προστασία της ταυτότητας και φήμης, και των προσωπικών δεδομένων κατά την παραγωγή δεδομένων μέσω διαφόρων ψηφιακών εργαλείων, περιβαλλόντων και υπηρεσιών.

## 3) Δημιουργία ψηφιακού περιεχομένου:

### 3.1 Ανάπτυξη ψηφιακού περιεχομένου

Δημιουργία και επεξεργασία ψηφιακού περιεχομένου.

### 3.2 Ολοκλήρωση και εκπόνηση ψηφιακού περιεχομένου

Βελτίωση και ενσωμάτωση πληροφοριών και περιεχομένου σε ένα υπάρχον σώμα γνώσεων

### 3.3 Πνευματικά δικαιώματα και άδειες

Άδειες χρήσης σε δεδομένα, πληροφορίες και ψηφιακό περιεχόμενο

### 3.4 Προγραμματισμός

Σχεδιασμός και ανάπτυξη κατανοητών οδηγιών για την επίλυση ενός δεδομένου προβλήματος ή εκτέλεση μιας συγκεκριμένης εργασίας από ένα υπολογιστικό σύστημα

## 4) Ασφάλεια:

Προστασία συσκευών, περιεχομένου, προσωπικών δεδομένων και ιδιωτικότητας σε ψηφιακά περιβάλλοντα. Προστασία της σωματικής και ψυχικής υγείας και συνειδητοποίηση των ψηφιακών τεχνολογιών για την κοινωνική ευημερία και την κοινωνική ένταξη. Επίγνωση περιβαλλοντικών επιπτώσεων από τη χρήση των ψηφιακών τεχνολογιών.

## 5) Επίλυση προβλημάτων:

### 5.1 Επίλυση τεχνικών προβλημάτων

Εντοπισμός τεχνικών προβλημάτων κατά τη λειτουργία συσκευών και τη χρήση ψηφιακών περιβαλλόντων, και δυνατότητα επίλυση τους

5.2 Αναγνώριση προσωπικών αναγκών, εντοπισμό και επιλογή τεχνολογικών λύσεων και προσαρμογή ψηφιακών περιβαλλόντων σε προσωπικές ανάγκες (π.χ. προσβασιμότητα).

5.3 Δημιουργική χρήση ψηφιακών τεχνολογιών

Χρήση ψηφιακών εργαλείων και τεχνολογιών για τη δημιουργία γνώσεων και καινοτόμων διαδικασιών και τεχνολογικών προϊόντων σε ψηφιακά περιβάλλοντα.

#### 5.4 Αναγνώριση κενών ψηφιακής επάρκειας των ατόμων

Κατανόηση και εντοπισμός ψηφιακών ικανοτήτων και τρόπων βελτίωσης ψηφιακής ικανότητάς καθώς και υποστήριξη άλλων για την ανάπτυξη των ψηφιακών ικανοτήτων τους. Αναζήτηση ευκαιριών αυτο-ανάπτυξης και ενημέρωση ως προς την ψηφιακή εξέλιξη.

### **Προηγμένες και Καινοτόμες Ψηφιακές Δεξιότητες και Ικανότητες**

Πέραν των βασικών δεξιοτήτων έχει αναγνωρισθεί επίσης η ανάγκη ανάπτυξης **Προηγμένων** ψηφιακών δεξιοτήτων και **Καινοτόμων** Δεξιοτήτων (UNESCO, 2017).

Προηγμένες Ψηφιακές Δεξιότητες (οριζόντιες). Στο προηγμένο φάσμα των ψηφιακών δεξιοτήτων είναι οι δυνατότητες υψηλού επιπέδου χρήσης της τεχνολογίας που επιτρέπει στους χρήστες και όλους τους επαγγελματίες να χρησιμοποιούν τις ψηφιακές τεχνολογίες με ισχυρούς και μετασχηματιστικούς τρόπους όπως οι επαγγελματίες ΤΠΕ. Σημαντικοί ψηφιακοί μετασχηματισμοί, όπως η Τεχνητή Νοημοσύνη (AI), η μηχανική μάθηση, η ανάλυση μεγάλων δεδομένων, αλλάζουν τις απαιτήσεις των ψηφιακών δεξιοτήτων που με τη σειρά τους, έχουν αντίκτυπο στην ανάπτυξη ικανοτήτων και ανάπτυξη δεξιοτήτων για την ψηφιακή οικονομία του 21ου αιώνα.

Παραδείγματα που απαιτούν Προηγμένες Ψηφιακές Δεξιότητες:

- ❖ Ανάπτυξη Διαδικτυακών Υπηρεσιών
- ❖ Ανάλυση Δεδομένων μεγάλου Όγκου
- ❖ Διαχείριση Συστημάτων Υγείας
- ❖ Υποστήριξη και διαχείριση Δικτύων
- ❖ Ανασχεδιασμός Ηλεκτρονικών Υπηρεσιών
- ❖ Ανάπτυξη Ηλεκτρονικών Προμηθειών

Προηγμένες Ψηφιακές Δεξιότητες (τομεακές). Με τον καιρό, και την κατάκτηση μεγαλύτερη ψηφιακής ωριμότητας, μπορεί να εξειδικεύονται οι ψηφιακές ικανότητες και να συνδυάζονται με ένα ευρύ φάσμα ειδικών ρόλων κάτω από την ίδια ομπρέλα. Σε επόμενο στάδιο κάθε οριζόντια προηγμένη δεξιότητα θα εξειδικεύεται περαιτέρω για κάθε επαγγελματικό προφίλ και θα δημιουργεί κάθετες πιο συγκεκριμένες δεξιότητες συγκεκριμένων κλάδων:

Καινοτομικές δεξιότητες για μια ψηφιακή διοίκηση και οικονομία. Για να υλοποιήσουν τις ευκαιρίες που παρουσιάζει η ψηφιοποίηση, οι κυβερνήσεις πρέπει να κατανοήσουν τον τρόπο με τον οποίο αλλάζουν οι θέσεις εργασίας και τα προσόντα που απαιτούνται από αυτές τις θέσεις εργασίας. Παραδείγματα:

- ο Ευφυείς Υπηρεσίες
- ο Υπηρεσίες μέσω κινητών
- ο Ηλεκτρονική Επιχειρηματικότητα
- ο Λοιπές παράμετροι Ψηφιακού Μετασχηματισμού

Οι συνεχείς τεχνολογικές εξελίξεις αναδύουν νέες απαιτήσεις σε δεξιότητες και ικανότητες οι οποίες απαιτούν συνεχείς προσαρμογές, διερευνώντας νέες τροχιές μάθησης στην πορεία εξέλιξης του ατόμου. Ως εκ τούτου απαιτείται σύνδεση της εξελικτικής μαθησιακής πορείας ανάπτυξης των δεξιοτήτων και ικανοτήτων με τους τυπικούς, μη τυπικούς και άτυπους τρόπους συνεχιζόμενης μάθησης. Η «πλήρωση» ενός συγκεκριμένου κενού δεξιοτήτων πρέπει να συνδέεται με τις υπάρχουσες δεξιότητες, τις δυνατότητες μάθησης που ακολουθούν αλλά και πιθανές συμπληρωματικές δεξιότητες για την ολοκλήρωσή τους. Στη πλέον ψηφιακά συνδεδεμένη οικονομία και κοινωνία για να ευδοκιμήσουν οι ψηφιακές δεξιότητες πρέπει αν λειτουργήσουν μαζί με άλλες ικανότητες όπως ισχυρές δεξιότητες ενγραμματισμού και αριθμητικής, κριτική και δημιουργική σκέψη, σύνθετη επίλυση προβλημάτων, ικανότητα συνεργασίας και κοινωνικοσυναισθηματικές δεξιότητες.

Η CEN δημοσίευσε τη δεύτερη έκδοση των ευρωπαϊκών προφίλ επαγγελματικών ρόλων στον τομέα των ΤΠΕ. Σύμφωνα με αυτή τα τριάντα (30) προφίλ επαγγελματικών ρόλων των ΤΠΕ παρέχουν ένα γενικό σύνολο τυπικών ρόλων που εκτελούνται από επαγγελματίες ΤΠΕ σε κάθε οργανισμό, καλύπτοντας τις πλήρεις επιχειρηματικές διαδικασίες ΤΠΕ χρησιμοποιώντας το ευρωπαϊκό πλαίσιο ηλεκτρονικής επάρκειας (e-CF) ως βάση για τον εντοπισμό των ικανοτήτων · ώστε να φωτίζει και να διαρθρώνει κάθε επαγγελματικό προφίλ ΤΠΕ με διάφορα στοιχεία, συμπεριλαμβανομένων των αποτελεσμάτων εργασίας ή των «επιτευγμάτων».

### **Τρέχουσα κατάσταση στην εκπαίδευση ψηφιακών δεξιοτήτων στη Δημόσια Διοίκηση**

Β. Θεματικές κατηγορίες που περιλαμβάνονται και προωθούνται από το ΙΝΕΠ.

Στο Θεματικό Κύκλο της Πληροφορικής και Ψηφιακών Υπηρεσιών η συντριπτική πλειοψηφία των επιμορφωτικών προγραμμάτων, σε ποσοστό 93%, επικεντρώνεται στην ανάπτυξη της ψηφιακής ικανότητας. Τα επιμορφωτικά προγράμματα του Θεματικού Κύκλου **για τις ψηφιακές δεξιότητες, στο οποίο συμβάλλουν και όλοι σχεδόν οι κύκλοι του ΙΝΕΠ**, δίνουν τη δυνατότητα ολοκληρωμένης επιμόρφωσης σε θέματα:

**Βασικών ψηφιακών δεξιοτήτων και ικανοτήτων** όπως ενδεικτικά ψηφιακή περιήγηση, διερεύνηση, επεξεργασία κειμένου, ανάλυση δεδομένων με λογιστικά φύλλα (Excel), εργαλεία σύνθεσης παρουσιάσεων (Power point), εισαγωγικά θέματα στη χρήση ηλεκτρονικών υπολογιστών, ηλεκτρονική συνεργασία, ηλεκτρονική διαχείριση εγγράφων, ψηφιακές υπογραφές, GDPR, ανοικτά δεδομένα, ανοικτή διακυβέρνηση κλπ.

**Προηγμένων Ψηφιακών Δεξιοτήτων:** Ανάπτυξη διαδικτυακών εφαρμογών και Πληροφοριακών Συστημάτων ηλεκτρονικής διακυβέρνησης (π.χ. ηλεκτρονικό πρωτόκολλο, ηλεκτρονικές συμβάσεις κλπ.),

Βάσεις Δεδομένων Βασικά Μητρώα και Διαχείριση Μητρώων (Oracle, Access κλπ. Μητρώο Πολιτών, Μητρώο Επιχειρήσεων κλπ.), Εξειδικευμένες γλώσσες προγραμματισμού (Java, Python κλπ.)

**Λειτουργικά Συστήματα, Δίκτυα και Ψηφιακές Υποδομές** (Windows server, Cisco, Linux, cloud computing κλπ. )

**Στατιστική Ανάλυση Δεδομένων**, σε ποσοστό 5% εμφανίζονται επιμορφωτικά προγράμματα που δίνουν έμφαση στην **μαθηματική ικανότητα** και ανάλυση (π.χ. Ανάλυση Δεδομένων , Στατιστική συμπερασματολογία ανάλυση εμπειρικών δεδομένων (SPSS.Minitab κλπ.).

Ασφάλεια Πληροφοριακών Συστημάτων

Συστήματα Ανάπτυξης Περιεχομένου

Ειδικά Πληροφοριακά Συστήματα (Προμηθειών, Φορολογίας κλπ.)

Καινοτόμων Ψηφιακών Δεξιοτήτων

Μοντελοποίηση και Ανασχεδιασμός Ψηφιακών Υπηρεσιών

Αξιολόγηση Διαλειτουργικότητας Παρεχόμενων Υπηρεσιών

Στατιστικός Ποιοτικός έλεγχος

Στις ψηφιακές δεξιότητες συμβάλλουν επίσης και όλοι σχεδόν οι κύκλοι του ΙΝΕΠ προσφέροντας πιο soft δράσεις όπως γενικά θέματα επικοινωνίας, συνεργασίας,

Ενδεικτικά αναφέρεται ότι τα τελευταία 5 χρόνια οι δράσεις του ΙΝΕΠ μέσω όλων των κύκλων του ΙΝΕΠ, αφορούν πρωτίστως την προώθηση των ψηφιακών ικανοτήτων στη διοίκηση, όπως φαίνεται από τα αποτελέσματα σχετικής έρευνας (Τερζή κ.ά. 2017):

Αυτή είναι και η στρατηγική χρησιμότητα του **Βαρόμετρου Ψηφιακής Προσαρμοστικότητας των Δημόσιων Οργανισμών και Φορέων της Κεντρικής Κυβέρνησης**. Έρχεται με φιλόδοξη διάθεση να καλύψει όλες αυτές τις ελλείψεις, να συστήσει αυτό το περιβόητο ολοκληρωμένο μεθοδολογικό περιβάλλον πρωτογενούς έρευνας (με δημιουργία αντίστοιχου ΠΣ στη συνέχεια) των ως άνω πεδίων και επίσης να φέρει σε κοινό χώρο σύγκρισης και επεξεργασίας όλα τα διαθέσιμα διοικητικά και επιστημονικά στοιχεία υπολοίπων εγχώριων , υπερεθνικών και διεθνών μελετών και βάσεων δεδομένων.

Στρατηγική επιδίωξη αποτελεί αυτή η **σταθερή μόνιμη, χρονοσυνεχής έρευνα/μελέτη με αντικείμενο το ψηφιακό μετασχηματισμό της αγοράς εργασίας (Digital Transformation of Labor Market), της μόνιμης μέτρησης του βαθμού ψηφιακής προσαρμογής του Δημοσίου Τομέα και των Δημόσιων Οργανισμών και Φορέων καθώς και η υλοποίηση της έννοιας New Digital Public Governance Strategy**.

Στρατηγικό πλεονέκτημα και μοανδικά ευνοϊκή χρονική συγκυρία αποτελούν αφενός η **ίδρυση του Ελληνικού Κέντρου Συλλογικής Τεχνογνωσίας για ευφείς δράσεις ενεργητικών πολιτικών εργασίας στη σύγχρονη ψηφιακή εποχή του Υπουργείου Εργασίας**, αφετέρου το γεγονός ότι ο γράφων εμπλέκεται σε μια



σειρά από αρμοδιότητες ( Συντονιστής της διεπιστημονικής πρωτοβουλίας ReBrain Greece για το Brain Drain και τον Τεχνολογικό Μετασχηματισμό της Αγοράς Εργασίας, Εθνικός Συντονιστής του Μηχανισμού Διάγνωσης των Αναγκών της Αγοράς Εργασίας του Υπουργείου Εργασίας, μέλος των High Level Expert Group on Labour Market Digital

Transformation της DG Connect της ΕΕ και DSM Group, ιδρυτικό μέλος της Εθνικής Συμμαχίας Ψηφιακών Δεξιοτήτων της Ελλάδας, και μέλος της τεχνικής κοινωνικής και οικονομικής επιτροπής της DG EMPL. της ΕΕ).

Εικόνα 1: Μετάβαση Κράτους από το αναλογικό στο ψηφιακό

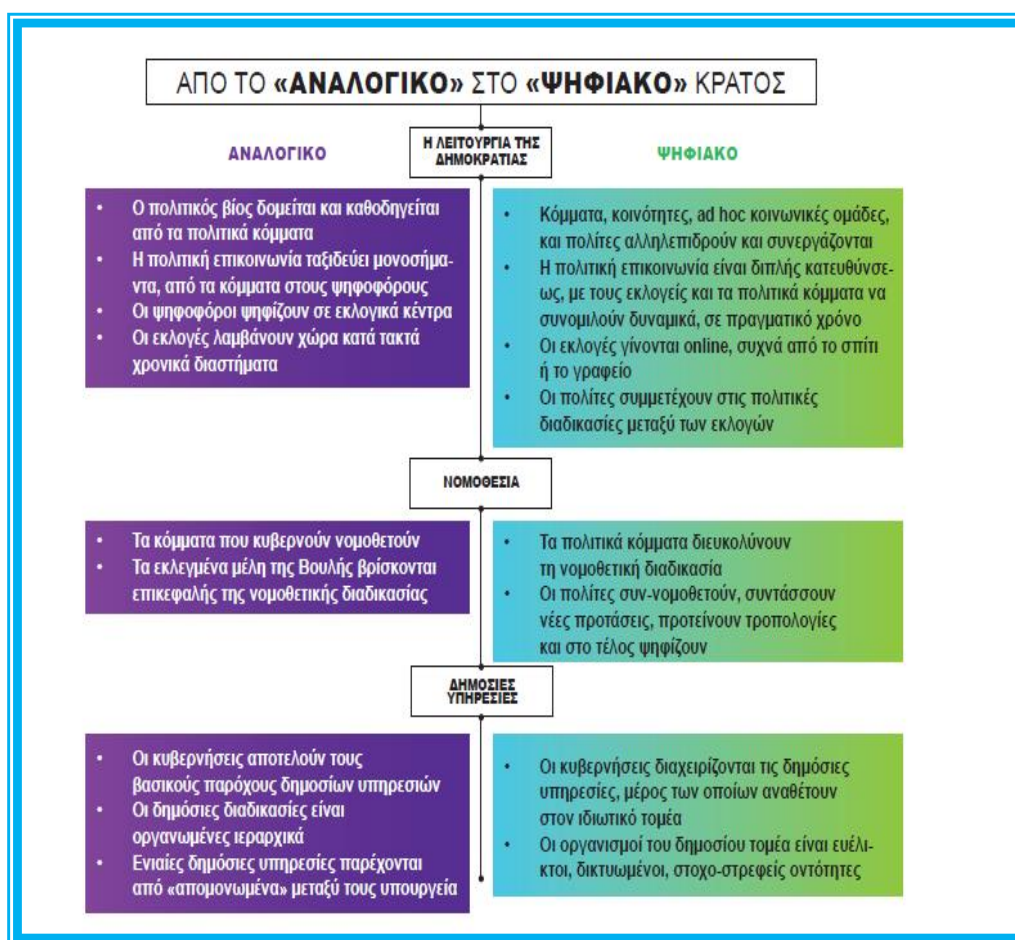

Πηγή: ΣΕΒ (2017).

Στο πλαίσιο αυτό και ως ερευνητικός κορμός της διδακτορικής μου διατριβής, προτείνεται να αναπτυχθεί το ερευνητικό και ριζικά σύγχρονο μεθοδολογικό εργαλείο του **Ψηφιακού Βαρόμετρου Προσαρμοστικότητας/Απόδοσης των Δημοσίων Οργανισμών και Φορέων**, που ευελπιστώ να εξελιχθεί και σε μόνιμο πληροφοριακό σύστημα του διαμορφούμενου «επαναστατικά τεχνοκρατικού», νέου Οργανισμού/Φορέα του Υπουργείου Εργασίας και Κοινωνικών Υποθέσεων για την παροχή evidence based στρατηγικών προτάσεων πολιτικής για σειρά Δημοσίων Φορέων και Οργανισμών της Κεντρικής Κυβέρνησης σε πρώτη φάση, στις περιφέρειες και τον ευρύτερο δημόσιο τομέα σε δεύτερο επίπεδο και στην επικράτεια σε γ' φάση.

**B. Growth Mindset on action: Παρουσίαση μιας νέας μεθοδολογικής καινοτομίας: «Ψηφιακό Βαρόμετρο Προσαρμοστικότητας των Δημοσίων Οργανισμών και Υπηρεσιών».**

Το πρωτοποριακό αυτό εργαλείο που προτείνεται να σχηματοποιηθεί ιδανικά, εντός του υπό θεσμοθέτηση νέου θεσμικού οργανισμού του Υπουργείου Εργασίας για την παραγωγή ευφών δράσεων ενεργητικών πολιτικών απασχόλησης, έρχεται να καλύψει ένα σημαντικό μελετητικό κενό της Ελληνικής Δημόσιας Διοίκησης. Αποτελεί τον ερευνητικό πυλώνα του τεχνοκρατικού και επαναστατικά τεχνοκρατικού οργανισμού του Υπουργείου και φέρει έξι (6) σημαντικές καινοτομίες:

**α)** Καλύπτει ερευνητικά πεδία που μέχρι τώρα μόνο σποραδικά, περιστασιακά, ή «φωτογραφικά» έχουν μελετηθεί, χωρίς συγκρισιμότητα.

**β)** εισάγει τη διάσταση της μόνιμης εισροής στοιχείων, τη χρονοσυνέχεια και τη μονιμότητα πληροφοριών και μεταδεδομένων, και την επεξεργασία τους σε βάθος,

**γ)** συνδυάζει την προσέγγιση της πολυκριτηριακής ανάλυσης με πολλές πηγές και επίπεδα/στρώματα πληροφοριών: στατιστικές –απεικονιστικές έρευνες, διοικητικές βάσεις δεδομένων, μόνιμες μικρές στοχευμένες έρευνες, στοιχεία μελετών ιδιωτικών ερευνών και χρήσιμα δεδομένα Εθνικών Πληροφοριακών Συστημάτων με αντίστοιχη διαδικασία «ουδετεροποίησης». Έτσι επιτυγχάνεται όχι μόνο η «φωτογραφική» κάλυψη ενός δείγματος με αναγωγή στο γενικό σύνολο (μια φορά το χρόνο), αλλά και η δυναμική διάσταση των στοιχείων με την καταγραφή και επεξεργασία συνεχών ροών, κάνοντας πραγματικότητα τη χρήση LMI προσεγγίσεων.

**δ)** Στοχεύει στη δημιουργία ενός μοντέλου πρόβλεψης των επόμενων ψηφιακών ή υψηλών δεξιοτήτων, επαγγελματών, κλάδων, μορφών εργασίας, νέων ψηφιακών εργασιακών, κενών, παροχή υψηλής αξίας mentoring σε μια σειρά από ωφελούμενος κλπ.

**ε)** Εμπλέκει και αξιοποιεί την τεχνογνωσία του γράφοντος από τη συμμετοχή του σε τεχνικές ομάδες εργασίας ψηφιακής οικονομίας της ΕΕ, δίνοντας πχ συγκρισιμότητα στο όλο εγχείρημα με άλλες ευρωπαϊκές αντίστοιχες προσπάθειες.

**στ)** Επιχειρεί σε επόμενη φάση να δημιουργήσει εντός του Πανεπιστημίου Πειραιά ΟΠΣ με προοπτική διαλειτουργικότητας με όλα τα σχετικά με το θέμα Εθνικά ΟΠΣ.

Το ψηφιακό βαρόμετρο μετρά την ψηφιακή ωριμότητα των Ελληνικών Δημοσίων Οργανισμών ενώ στοχεύει παράλληλα στην εγγυή αποτύπωση της μεταβολής της Ελληνικής Αγοράς Εργασίας στα επαγγέλματα, τους κλάδους, τις νέες δεξιότητες, στα τυπικά και άτυπα συστήματα επαγγελματικής κατάρτισης, προβλέψεις για τις «μετατοπίσεις» και μεταβολές των επαγγελμάτων και κλάδων της οικονομίας. (σε συνεργασία με το Μηχανισμό Διάγνωσης της Αγοράς Εργασίας του Υπουργείου Εργασίας)

Εξετάζει την διαδικασία διαχείρισης της ψηφιακής μετάβασης των Δημοσίων Οργανισμών στον κόσμο των Εκθετικών Ψηφιακών Οικοσυστημάτων ( Digital Transition Management of Public Organizations) Τέλος, αποσκοπεί στο να προτείνει τρόπους επωφελούς αξιοποίησης των Νέων Ψηφιακών Επιχειρησιακών Μοντέλων του Δημοσίου Τομέα. (New Public Organizations' business model structures).

Μεθοδολογικά, το ερευνητικό μέρος του Βαρόμετρου εδράζεται σε ένα σχήμα 2 πυλώνων, ποιοτικού και ποσοτικού, 3X3 διαστάσεων.

**Ο ποιοτικός περιλαμβάνει τις διαστάσεις:**

**A) Legitimacy Dimension** με τρεις δείκτες: i) Public Confidence (πόσο σας εκπέμπουν ψηφιακή αξιοπιστία και εμπιστοσύνη), ii) Stakeholder engagement (Πόσο μετέχουν ψηφιακά τα στελέχη του φορέα στις τελικές υπηρεσίες ή άλλοι συνεργαζόμενοι φορείς), iii) Political Commitment (ο βαθμός έντασης της πολιτικής αφοσίωσης στη ψηφιακή μετάβαση).

**B) Policy Dimension** με τρεις δείκτες: i) Objectives \_s.m.a.r.t. (πόσο τίθενται πολιτικοί στόχοι ψηφιακοί ή/και ψηφιακής μετάβασης, πόσο εκπέμπουν ψηφιακή αξιοπιστία και εμπιστοσύνη). ii) Evidence based digital targets/objectives (Πόσο τεκμηριωμένοι είναι οι ψηφιακοί στόχοι βάσει στοιχείων και δεδομένων), iii) Feasibility (ο βαθμός έντασης της πολιτικής αφοσίωσης στη ψηφιακή μετάβαση).

**Γ) Action Dimension** με τρεις δείκτες: i) Digital Management notion (ποιος είναι ο βαθμός εδραίωσης διαδικασιών ηλεκτρονικής διακυβέρνησης πόσο έχουν εγκατασταθεί ψηφιακές λειτουργίες στους δημόσιους φορείς ii) Measurement framework\_digital KPI's (Πόσο έχουν εγκατασταθεί και χρησιμοποιούνται συστήματα α) ψηφιακής αποδοτικότητας των δημοσίων οργανισμών και β) πόσο υπάρχουν συστήματα ψηφιακής μέτρησης των εσωτερικών διαδικασιών iii) Alignment (α)πόσο έχει ευθυγραμμιστεί ο δημόσιος οργανισμός ή έχει δημιουργήσει διαδικασίες ευθυγράμμισης και σύγκρισης με τις ψηφιακές απαιτήσεις των πολιτών και των επιχειρήσεων ή της αγοράς, β) πόσο έχουν ενσωματώσει οι δημόσιοι οργανισμοί κοινές ψηφιακές διαδικασίες

**Εικόνα 2: Ποιοτικός Πυλώνας: 3X3 διαστάσεων με ποιοτική και ποσοτική αξιολόγηση**



**Ο ποσοτικός πυλώνας περιλαμβάνει τις εξής διαστάσεις και δείκτες μέτρησης:**

**A) Digital capabilities dimension** (ψηφιακές δυνατότητες/ικανότητες) με τους εξής δείκτες μέτρησης: i) Individual-Προς τον πολίτη/πελάτη ιδιώτη (πόσο παρέχουν οι δημόσιοι οργανισμοί/φορείς ψηφιακές παροχές, ψηφιακά προϊόντα, διαδικασίες κλπ), ii) enterprises-προς τις επιχειρήσεις (πόσο παρέχουν οι δημόσιοι οργανισμοί/φορείς ψηφιακές παροχές, ψηφιακά προϊόντα, διαδικασίες κλπ), iii) customers-προς «εσωτερικούς χρήστες» (ο βαθμός έντασης της πολιτικής αφοσίωσης στη ψηφιακή μετάβαση).

**B) Digital enablers dimension** (ψηφιακοί υποκινητές/διευκολυντές) με δείκτες: i) REACH INDEX: Ισομερής, σχετική, διαδραστική (αμφίδρομη) ψηφιακή πρόσβαση του % προσωπικού επί του συνόλου στον οργανισμό, ii) Structure (Ψηφιακή Οργανωσιακή Δομή): Ύπαρξη virtual λειτουργικών μονάδων, όπως διαδικτυακές κοινότητες και δίκτυα και φόρα, που υποστηρίζουν και λειτουργούν παράλληλα με τις ιεραρχικές δομές, iii) Process: ενεργοποίηση νέων απλούστερων διαδικασιών λειτουργίας που αναπαριστούν οριζόντια και συνεργατικά δίκτυα λειτουργίας εντός του οργανισμού.

**Γ) Mindset dimension** (κουλτούρα και νοητική προσέγγιση) με δείκτες: i) Culture: (συμπεριφορές, στάσεις, αντιλήψεις και προσδοκίες των εργαζόμενων του οργανισμού σχετικά με το μέγεθος, την έκταση και την ένταση του ψηφιακού μετασχηματισμού και των συνεπειών του, ii) Leadership: η επιρροή από κάθε επίπεδο management σε όλο τον οργανισμό που συντελεί, iii) Asset: α) Η ένταξη ψηφιακού ή cloud χώρου εργασίας του οργανισμού στην επίσημη έννοια της δομής του οργανισμού β) ο βαθμός επιρροής των ψηφιακών δομών του οργανισμού στις τελικές υπηρεσίες του οργανισμού.

Σε όλους τους δείκτες και τις διαστάσεις και των 2 πυλώνων θα χρησιμοποιηθεί η τεχνική της διπλής συγχρονισμένης αξιολόγησης με ποιοτική αξιολόγηση με Lacking, weak, fair, good, strong, solid και με ποσοτική με βαθμό 1-10. Ο λόγος που ο πρώτος καλείται ποιοτικός και ο δεύτερος ποσοτικός προκύπτει από το γεγονός ότι ο πρώτος έχει μεγαλύτερης έντασης/πρωτεύουσας σημασίας ποιοτικούς αξιολογικούς

προσδιορισμούς, ενώ ο δεύτερος αντίστοιχα αξιολογεί πρώτα ποσοτικά το βαθμό πλήρωσης των ζητούμενων δεικτών, συμπληρούμενος από το ποιοτικό επίπεδο.

Εικόνα 3: Ποσοτικός άξονας 3X3 διαστάσεων με ταυτόχρονη ποσοτική και ποιοτική αξιολόγηση

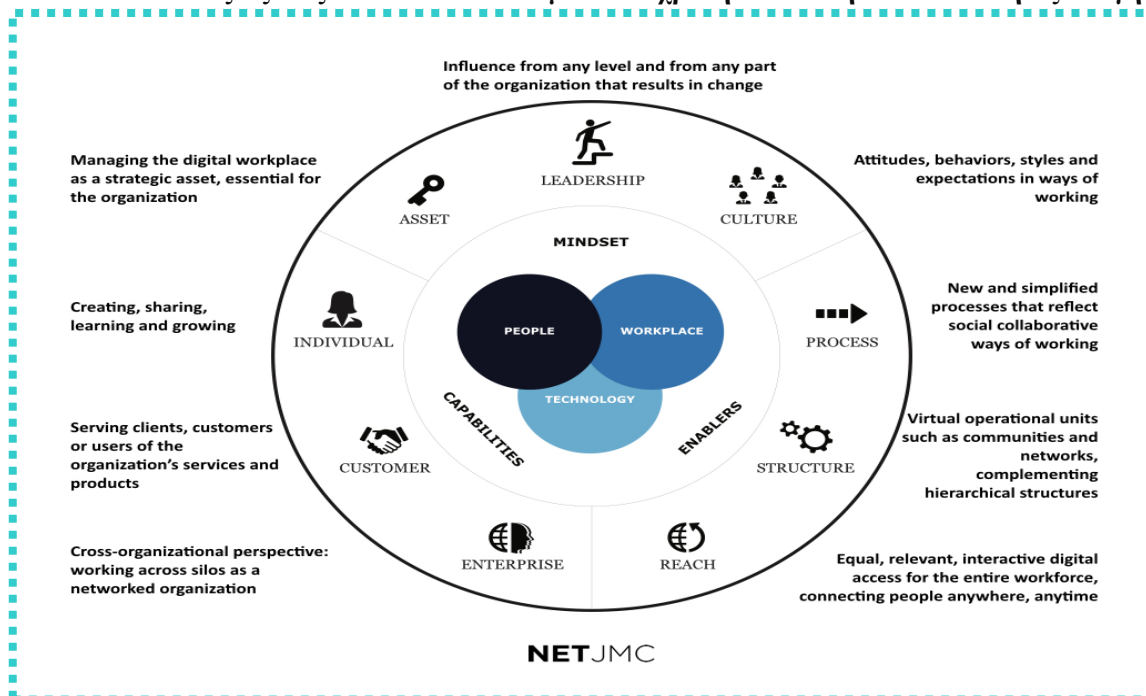

Πηγή: NETJMC (2017)

## Βιβλιογραφικές Αναφορές

- Council & European Parliament (2006). Recommendation of the European Parliament and the Council of 18 December 2006 on key competences for lifelong learning, 2006/962/EC, OJ L 394 Council of the EU (2017). Council Conclusions on the Future of Work: Making it e-Easy. Available at: <http://data.consilium.europa.eu/doc/document/ST-15506-2017-INIT/en/pdf>
- DigComp (2013). A Framework for Developing and Understanding Digital Competence in Europe. JRC.
- Elkin, G. (1990). Competency – based human resource development. *Industrial & Commercial Training*, 22 (4): 20-25.
- Eurofound (2018a). *New forms of employment*. Eurofound.
- Eurofound (2018b). *Working Conditions. Overview of new forms of employment*. Eurofound.
- Grunke et al. (2018). Which skills in the digital era: returns to skills analysis. *OECD STI Working Paper*. Paris: OECD.
- ILO (2014). Annual Official Paper on Labour Market Digital Transformation. ILO
- McKinsey Global Institute (2014). Annual Forecast Research.
- NETJMC (2017). Foundational Frameworks for the Digital Age. Available at: <https://www.netjmc.com/9-dimensions-of-the-organization-in-the-digital-age/>
- OECD (2016). Skills for a Digital World. Background report on the ministerial meeting on the digital economy. Paris: OECD.
- OECD (2017a). STI Scoreboard 2017. The digital transformation. Paris: OECD.
- OECD (2017b). Business models for sustainable research data repositories. Available at: [https://www.oecd-ilibrary.org/science-and-technology/business-models-for-sustainable-research-data-repositories\\_302b12bb-en](https://www.oecd-ilibrary.org/science-and-technology/business-models-for-sustainable-research-data-repositories_302b12bb-en).
- OECD (2017c). Co-ordination and support of international research data networks. Available at: [https://www.oecd-ilibrary.org/science-and-technology/co-ordination-and-support-of-international-research-data-networks\\_e92fa89e-en](https://www.oecd-ilibrary.org/science-and-technology/co-ordination-and-support-of-international-research-data-networks_e92fa89e-en)
- OECD (2017d). Highlights from the OECD Science, Technology and Industry Scoreboard 2017 - The Digital Transformation: Greece. Available at: <https://www.oecd.org/greece/sti-scoreboard-2017-greece.pdf>

- Osborne & Frey's (2013). Two-year research: "the changing nature of labour framework". JRC Publications Repository.
- ΣΕΒ (2017). Η Ψηφιακή Ελλάδα. Ο Δρόμος προς την Ανάπτυξη. Διαθέσιμο στο: [https://www.sev.org.gr/uploads/Documents/Digital\\_Greece\\_060517\\_full\\_hi\\_res.pdf](https://www.sev.org.gr/uploads/Documents/Digital_Greece_060517_full_hi_res.pdf)
- The World Bank (2016). Elaboration Research on Digital Transformation. The World Bank.
- Van Deursen, Helsper & Eynon (2016). Development and validation of the Internet Skills Scale. LSE.

### 13.5. Social Security, Social Welfare in Greece and Europe in the Crisis Period, 2009-2019

*Konstantinos Memos*

#### **Abstract**

In the sphere of modern developments of the last 10 years, the political phenomenon is shifting to face the global challenges in the economy and therefore in the society.

The intense manipulation of stock markets, of global economy and of even some countries since 2010-2011 has had a negative impact on the ideology and policies of individual governments with negative effects on local societies and especially on citizens' welfare, welfare state, work, social life, insurance and health in particular those where financial adjustment programs have been and are being implemented.

The Social Security System in Greece was in crisis long before the 2009 crisis. In 1980, the first deficits appeared in many funds. A system with the highest insurance contributions at European level which faces serious sustainability problems. Legislative developments during the crisis have made the Insurance System worse, and in order to ensure its viability, the policies in place have focused on increasing revenue and reducing costs, therefore highlighting unfairness among the currently insured and those of future generations. In Europe supplementary insurance (occupational funds) works in addition to Social Security and has ensured higher levels of benefits and social efficiency.

The implemented economic policy in Greece, as in other European countries, has led to a reduction in the public deficit through the reduction of wage pensions, social spending and, in general, the decline of the social state. Social spending is seen as consuming and the welfare state is further shrinking.

**Keywords:** Social Security, Social Welfare, Financial Crisis

### **Κοινωνική Ασφάλιση, Κοινωνική Πρόνοια στην Ελλάδα και στην Ευρώπη την Περίοδο της Κρίσης, 2009-2019**

*Κωνσταντίνος Μέμος<sup>2</sup>*

#### **Περίληψη**

Η κεντρική επιδίωξη της έρευνας επικεντρώνεται στις επιπτώσεις της 10 ετούς οικονομικής κρίσης, που έπληξε την Ευρώπη και την Ελλάδα ειδικότερα, στην Κοινωνική Ασφάλιση και στην Κοινωνική Πρόνοια. Πιο συγκεκριμένα μελετώνται οι Κοινωνικές επιπτώσεις της οικονομικής κρίσης στα Συστήματα Κοινωνικής Ασφάλισης και Πρόνοιας καθώς επίσης και οι επιπτώσεις από τις εφαρμοζόμενες πολιτικές ανάσχεσης της κρίσης. Ακολουθείται μια ποσοτική και βιβλιογραφική διερεύνηση με βάση διαθέσιμα στατιστικά στοιχεία από επίσημους οργανισμούς, εκθέσεις Τραπεζών και Ινστιτούτων.

**Λέξεις κλειδιά:** Κοινωνική Ασφάλιση, Κοινωνική Πρόνοια, Οικονομική Κρίση

<sup>2</sup> Διδάσκων (ΕΔΙΠ) Τμήματος Κοινωνικής Πολιτικής, Γνωστικό Αντικείμενο: Κοινωνική Ασφάλιση και Διαχείριση Αποθεματικών, Πάντειο Πανεπιστήμιο Κοινωνικών και Πολιτικών Επιστημών.

## **Εισαγωγή**

Στη σφαίρα των σύγχρονων εξελίξεων των τελευταίων 10 ετών μεταλλάσσεται το πολιτικό φαινόμενο για να αντιμετωπίσει τις παγκόσμιες προκλήσεις στην οικονομία και κατ' επέκταση στην κοινωνία.

Η έντονη χειραγώγηση από το 2010-2011 χρηματιστηρίων, της παγκόσμιας οικονομίας ακόμη και κρατών είχε αρνητικές συνέπειες στην ιδεολογία και στις εφαρμοζόμενες πολιτικές των εκάστων κυβερνήσεων με αρνητικές συνέπειες στις τοπικές κοινωνίες και ιδιαίτερα στη διαβίωση των πολιτών, στο κράτος πρόνοιας, στην εργασία, στην κοινωνική ασφάλιση και στην υγεία ιδιαίτερα σε όσες εφαρμόστηκαν και εφαρμόζονται προγράμματα δημοσιονομικής προσαρμογής. Το Σύστημα Κοινωνικής Ασφάλισης στην Ελλάδα βρέθηκε σε κρίση πολύ πριν την κρίση του 2009. Το 1980 εμφανίστηκαν τα πρώτα ελλείμματα σε πολλά ταμεία. Ένα σύστημα με τις υψηλότερες ασφαλιστικές εισφορές σε επίπεδο Ευρώπης και αντιμετωπίζει σοβαρά προβλήματα βιωσιμότητας. Οι νομοθετικές εξελίξεις κατά την περίοδο της κρίσης οδήγησαν σε δυσμενέστερη κατάσταση το Ασφαλιστικό Σύστημα, και για να διασφαλιστεί η βιωσιμότητα του, οι εφαρμοζόμενες πολιτικές προσανατολίστηκαν στην αύξηση των εσόδων και μείωση των δαπανών και ανέδειξαν την αδικία μεταξύ των συμβεβλημένων και την αλληλεγγύη των επόμενων γενεών. Στην Ευρώπη η συμπληρωματική ασφάλιση (επαγγελματικά ταμεία) λειτουργεί επιπρόσθετα με την Κοινωνική Ασφάλιση και διασφάλισε υψηλότερα επίπεδα παροχών και κοινωνικής αποτελεσματικότητας

Η εφαρμοσμένη οικονομική πολιτική στην Ελλάδα, όπως και σε άλλες ευρωπαϊκές χώρες οδήγησε στη μείωση του δημοσίου ελλείμματος διαμέσου της μείωσης των συντάξεων των μισθών, των κοινωνικών δαπανών και γενικότερα της συρρίκνωσης του κοινωνικού κράτους. Οι κοινωνικές δαπάνες, αντιμετωπίζονται ως καταναλωτικές και συρρικνώνεται επιπρόσθετα το κοινωνικό κράτος.

### **1. Κοινωνική Ασφάλιση**

Η **κοινωνική ασφάλιση** είναι η δημόσια υποχρεωτική ασφάλιση που χρηματοδοτείται είτε από τις εισφορές εργοδότη και εργαζόμενου και σε κάποιες περιπτώσεις και του κράτους από τον κρατικό προϋπολογισμό μέσω της φορολογίας, για να εξασφαλίσει την κάλυψη των αναγκών που προκαλούνται στους εργαζόμενους από την απώλεια εισοδήματος λόγω ασθένειας, ανεργίας, αναπηρίας, γήρατος ή θανάτου. Η λειτουργία της κοινωνικής ασφάλισης είναι συλλογική και βασίζεται στις αρχές της συνεισφοράς, της ανταποδοτικότητας αλλά και της κοινωνικής αλληλεγγύης (Beveridge, 2942).

Η κοινωνική ασφάλεια σύμφωνα με τη Διεθνή Οργάνωση Εργασίας ορίζεται ως εξής: Η κοινωνική ασφάλεια είναι το σύνολο των θεσμών, των μέτρων, των δικαιωμάτων και των υποχρεώσεων των οποίων πρωταρχικός στόχος είναι να παρέχουν ή στοχεύουν να παρέχουν, σύμφωνα με συγκεκριμένους κανόνες, ασφάλεια εισοδήματος και ιατροφαρμακευτική περίθαλψη σε όλα τα μέλη της κοινωνίας (Θεοδωρουλάκης, 2008).

Η κοινωνική ασφάλιση αποβλέπει στην προστασία ορισμένων ομάδων του πληθυσμού από συγκεκριμένους κινδύνους. Πρόκειται για ένα είδος συμβολαίου μεταξύ εργαζομένων και μη εργαζομένων, που λειτουργεί ως σύστημα διαχρονικής κατανομής του εισοδήματος μεταξύ των διαφόρων γενεών, μέσω της πολιτικής



διαδικασίας από το μηχανισμό της αγοράς Μεταξύ της ατομική πρόνοιας και της κρατικής παρέμβασης για την αντιμετώπιση των κοινωνικών αναγκών παρεμβάλλεται και η συλλογική ιδιωτική πρωτοβουλία, η οποία στηρίζεται στην ιδιωτική πρωτοβουλία και έχει ομαδικό χαρακτήρα.

Τα ασφαλιστικά μοντέλα που έχουν αναπτυχθεί στις χώρες της Ευρωπαϊκής Ένωσης είναι: το διανεμητικό σύστημα (αλληλεγγύη των γενεών), το κεφαλαιοποιητικό σύστημα (αξιοποίηση της περιουσίας των ταμείων και της επένδυσης των εσόδων, ώστε να υπάρξει απόδοση και ο ιδιωτικός τομέας ασφάλισης, ο οποίος τοποθετείται εντός του κοινωνικο-ασφαλιστικού συστήματος.

Το ελληνικό ασφαλιστικό σύστημα, όπως άλλωστε και τα αντίστοιχα της Ευρώπης είναι δημόσιο και αναδιανεμητικό. Το σύστημα ως αναδιανεμητικό επιβάλλει και αναδεικνύει την αλληλεγγύη των γενεών. Κάθε γενιά αναλαμβάνει να καταβάλει τις συντάξεις της προηγούμενης. Το ασφαλιστικό σύστημα κατοχυρώνει την κοινωνική συνοχή και την καταπολέμηση του αποκλεισμού, μέσω της συμμετοχής στην ανάπτυξη της οικονομίας. Με αυτή την έννοια η μακροχρόνια ισορροπία του ασφαλιστικού συστήματος είναι βασική συνισταμένη της ανάπτυξης. Αντίθετα απειλές στην ισορροπία αυτή υποσκάπτουν μεσοπρόθεσμα την ανάπτυξη (Ρομπόλης κ.ά 1993).

Η Κοινωνική Ασφάλιση κατά τη διάρκεια των τελευταίων ετών βρίσκεται στο επίκεντρο σοβαρών αμφισβητήσεων, εξαιτίας των οικονομικών προβλημάτων που διακρίνουν από πρώτη άποψη τη λειτουργία της. Τα προβλήματα αυτά εντοπίζονται κατά κύριο λόγο στην ύπαρξη των χρηματοοικονομικών ελλειμμάτων και συνακόλουθα στην παρεμπόδιση της ανάπτυξης του συγκεκριμένου θεσμού με τη βελτίωση κυρίως, του επιπέδου των παροχών του και του επιπέδου εξυπηρέτησης των ασφαλισμένων και των συνταξιούχων.

Η δημοσιονομική πολιτική που ασκήθηκε στην Ευρώπη δεν άφησε ανεπηρέαστο και το Σύστημα κοινωνικής ασφάλισης. Για την κάλυψη του ελλείμματος του κοινωνικού προϋπολογισμού θεσπίστηκαν μέτρα όπως η αύξηση των ορίων ηλικίας συνταξιοδότησης, η αλλαγή του τρόπου υπολογισμού των συντάξεων και η διάρκεια του εργασιμου βίου των ασφαλισμένων.

Το Σύστημα Κοινωνικής Ασφάλισης στην Ελλάδα βρέθηκε σε κρίση πολύ πριν την κρίση του 2009. Το 1980 εμφανίστηκαν τα πρώτα ελλείμματα σε πολλά ταμεία. Ένα σύστημα με τις υψηλότερες ασφαλιστικές εισφορές σε επίπεδο Ευρώπης και αντιμετωπίζει σοβαρά προβλήματα βιωσιμότητας.

Όσον αφορά τη διάρθρωση του συστήματος, το ελληνικό μοντέλο διαρθρώνεται σε τρεις κύριους πυλώνες: ο πρώτος πυλώνας επικεντρώνεται στα υποσυστήματα της κύριας και της επικουρικής υποχρεωτικής ασφάλισης, ο δεύτερος πυλώνας περιλαμβάνει τα υποσυστήματα της συμπληρωματικής ασφάλισης και των επαγγελματικών ταμείων που πρόσφατα θεσμοθετήθηκαν (Ν.3029/2002) στη χώρα μας, ενώ ο τρίτος πυλώνας, κατά την άποψη της Παγκόσμιας Τράπεζας και του Διεθνούς Νομισματικού Ταμείου, αφορά τα προγράμματα ιδιωτικής ασφαλιστικής κάλυψης (ΓΓΚΑ, 2019).

Οι εφαρμοζόμενες πολιτικές λιτότητας με τους περιοριστικούς προϋπολογισμούς των κρατών-μελών αυξάνουν τους φόρους και την ανεργία, μειώνουν την ανάπτυξη και τα εισοδήματα, διευρύνουν το δημόσιο

χρέος τους και τροφοδοτούν την ευρωπαϊκή λαϊκή δυσaréσκεια η οποία εκδηλώνεται με διαφορετικούς τρόπους κινητοποιήσεων και αντιδράσεων των ευρωπαίων πολιτών.

Η αύξηση των ορίων ηλικίας συνταξιοδότησης επιδεινώνει το επίπεδο παραγωγικότητας των επιχειρήσεων και δρα σε βάρος της ανταγωνιστικότητας, της ανάπτυξης και του παραγόμενου ΑΕΠ. Έτσι, η αύξηση της ανεργίας, η γήρανση του πληθυσμού, η αύξηση του προσδόκιμου ορίου ζωής, η μείωση της ανάπτυξης, η αύξηση των επιπέδων του δημόσιου ελλείμματος και του δημόσιου χρέους και η μείωση της απασχόλησης έκαναν δυσχερέστερη την κατάσταση βιωσιμότητας των συνταξιοδοτικών συστημάτων στα κράτη-μέλη της Ευρωπαϊκής Ένωσης.

Ο προϋπολογισμός της Ε.Ε. χρηματοδοτεί μια πλειονότητα δράσεων και πολιτικών, οι οποίες αποφασίζονται από τα αρμόδια όργανα της Ένωσης σε συνεργασία με τα κράτη μέλη. Υπάρχουν πολιτικές για τις οποίες τα κράτη μέλη έχουν αποφασίσει να μη δρουν σε επίπεδο Ε.Ε. Χαρακτηριστικό παράδειγμα αποτελούν η Εθνική Κοινωνική Ασφάλιση, οι συντάξεις, το Σύστημα Υγείας, η Εκπαίδευση, αποτελούν πολιτικές οι οποίες χρηματοδοτούνται από τις εθνικές κυβερνήσεις.

Οι πολιτικές που εφαρμόζονται στην Ευρωπαϊκή Ένωση στοχεύουν στη σταθεροποίηση της ευρωπαϊκής οικονομίας με τη μείωση των μισθών, των εισοδημάτων, με την απορύθμιση των εργασιακών σχέσεων και του Συστήματος Κοινωνικής Ασφάλισης. Ανεπιτυχείς πολιτικές που όχι μόνο δεν επέλυσαν το πρόβλημα αλλά οδήγησαν σε αδιέξοδο πολλά κράτη μέλη.

Βασικό πρόβλημα σχετικά με την ασφάλιση στην Ευρώπη είναι η διατήρηση της διαφορετικότητας των εθνικών κοινωνικών πολιτικών. Παρά την τροποποίηση που πραγματοποιήθηκε στο άρθρο 117 της Συνθήκης της Ρώμης, η οποία αναφέρει ότι η κοινότητα και τα κράτη μέλη έχουν ως στόχο την προώθηση της απασχόλησης, τη βελτίωση των συνθηκών ζωής και εργασίας, την πλήρη κοινωνική προστασία, τον κοινωνικό διάλογο, την ανάπτυξη των ανθρώπινων πόρων επιτρέποντας έτσι ένα υψηλό και διαρκές επίπεδο απασχόλησης καθώς και τον περιορισμό των οποιοδήποτε αποκλίσεων. Με την τροποποίηση αυτή εκφράζεται η απομάκρυνση των προθέσεων για σύγκλιση των συστημάτων κοινωνικής προστασίας, με τη διατήρηση της διαφορετικότητας των εθνικών κοινωνικών πολιτικών.

Πέρα από τις αναγκαίες παρεμβάσεις για να διορθωθεί το μωσαϊκό των ρυθμίσεων και το χάος των ανισοτήτων έγινε προσπάθεια να διασφαλιστεί ότι οι οικονομικές διαχειριστικές παρεμβάσεις, δεν θα πλήξουν το δημόσιο και κοινωνικό χαρακτήρα της κοινωνικής ασφάλισης.

Το ελληνικό Σύστημα Κοινωνικής Ασφάλισης (ΣΚΑ) παρουσιάζει όλα τα χαρακτηριστικά ενός ιδιαίτερου τύπου κοινωνικού κράτους, όπως αυτό των χωρών της Νότιας Ευρώπης που χαρακτηρίζεται από την καθυστέρηση στη θεσμοθέτηση και επέκταση κοινωνικών προγραμμάτων και από την ύπαρξη σημαντικών κενών στην κοινωνική προστασία. Το ΣΚΑ βρισκόνταν σε κρίση και πριν την έλευση της οικονομικής κρίσης, με μειωμένα αποθεματικά κεφάλαια και μεγάλο ποσοστό εισφοροδιαφυγής. Το 1980 εμφανίστηκαν τα πρώτα ελλείμματα σε πολλά ταμεία.

Η οικονομική κρίση επιδείνωσε την κατάσταση που είχαν περιέλθει τα ασφαλιστικά ταμεία, με την αύξηση της ανεργίας, τη μείωση μισθών και τις ευέλικτες μορφές απασχόλησης. Τα έσοδα μειώθηκαν και η οικονομική κατάσταση των ταμείων επιδεινώθηκε ακόμη περισσότερο.

Η πολιτική των μνημονίων έχει καταλύσει δύο βασικές αρχές της κοινωνικής ασφάλισης. Την αρχή της αλληλεγγύης των γενεών και την αρχή της αναλογικότητας (αποδοτικότητα εισφορών παροχών). Οι ασκούμενες πολιτικές των μνημονίων στην Ελλάδα έχουν οδηγήσει, μεταξύ άλλων το επίπεδο των συντάξεων, σε ολοένα και μεγαλύτερο αριθμό στα όρια της φτώχειας.

Η μείωση 45% των κύριων, επικουρικών συντάξεων και του εφάπαξ κατά την περίοδο 2010-2014, επιδείνωσε το βιοτικό επίπεδο των συνταξιούχων και ταυτόχρονα συρρικνώθηκε σημαντικά το αποθεματικό κεφάλαιο της κοινωνικής ασφάλισης (4,5 δισ. ευρώ το 2013, 2,5 δισ. το 2015).

Κατά τη χρονική περίοδο 2010-2014 το Σύστημα Κοινωνικής Ασφάλισης υπέστη:

- **μείωση των δαπανών για συντάξεις** κατά 32% (33 δισ ευρώ το 2010 και 22 δισ ευρώ το 2014)
- **μείωση εισφορών από τη μείωση μισθών** κατά 33% (11,5 δισ ευρώ το 2010 και 7,5 δισ ευρώ το 2014)
- **μείωση αποθεματικού κεφαλαίου** (12,5 δισ ευρώ από το PSI, 27 δισ ευρώ το 2010 και το 2015 μόλις 2,5 δισ ευρώ)
- **μείωση της κρατικής επιχορήγησης** (18,9 δισ ευρώ το 2010 και 8,6 δισ ευρώ το 2014)
- **μείωση εσόδων λόγω ανεργίας** 4 δισ ευρώ ( 2,5 δισ ευρώ το 2010 και 6,5 δισ ευρώ το 2014)
- **μείωση εσόδων από εισφοροδιαφυγή** 15 δισ ευρώ το 2014 και **μείωση εσόδων από οφειλές** 17,4 δισ ευρώ το 2014.

Σύμφωνα με ακριβείς υπολογισμούς της ΕΝΥΠΕΚΚ (2019), οι πραγματικές απώλειες των Ασφαλιστικών Ταμείων από την εφαρμογή των μνημονιακών νόμων κατά την περίοδο 2010-2016 ανέρχονται σε τουλάχιστον 80 δισ ευρώ.

- Οι συνταξιούχοι της χώρας μας, την ίδια χρονική περίοδο απώλεσαν 50 και πλέον δισ ευρώ από τις συντάξεις τους.
- Περικοπές ύψους πάνω από 24 δισ ευρώ θα υποστούν οι συνταξιούχοι μας κατά την περίοδο 2016-2022. Ειδικότερα, θα υποστούν απώλειες: 8,2 δισ ευρώ από την εφαρμογή των διατάξεων του (4387/2016), 8 δισ ευρώ (2 δισ ευρώ επί 4 χρόνια) από τις εισφορές των συνταξιούχων υπέρ **ΕΟΠΥΥ** και 7,8 δισ ευρώ από τις περικοπές για τα έτη 2019-2022 από το συμπληρωματικό Μνημόνιο (Ν. 4472/2017) και τους εφαρμοστικούς του νόμους (Ν. 4475/2017 και 4488/2017).

Οι δανειστές παραγνωρίζοντας τα διαρθρωτικά και τα θεσμικά προβλήματα του συστήματος κοινωνικής ασφάλισης (ΣΚΑ) στην Ελλάδα καθώς και τις ιστορικές παθογένειες του, επέβαλαν από το 2010 μέχρι και το 2019 με το πρόσχημα της μη βιωσιμότητας του, στα πλαίσια των πολιτικών της εσωτερικής υποτίμησης και

της λιτότητας (Μνημόνια 1, 2, και 3), μέτρα περικοπών των συντάξεων, απορρύθμισης του χαρακτήρα και του θεσμικού πλαισίου οργάνωσης και λειτουργίας καθώς και χρηματοδότησης του ΣΚΑ.

Στην κατεύθυνση αυτή επέβαλαν, μεταξύ των άλλων, τη σύσταση του Ενιαίου Φορέα Κοινωνικής Ασφάλισης (ΕΦΚΑ), την οργάνωση της κύριας σύνταξης σε εθνική (υπό όρους και προϋποθέσεις) και την αναλογική σύνταξη, την σταδιακή μείωση της κρατικής χρηματοδότησης, τις περικοπές των συντάξεων (κύριες, επικουρικές, μερίσματα), που κατά την περίοδο 2010-2019 εκτιμώνται ότι θα είναι τουλάχιστον της τάξης των 50 δις ευρώ και την εφαρμογή της ρήτρας βιωσιμότητας (μηδενικού ελλείμματος) για το εφάπαξ και τις επικουρικές συντάξεις.

Με τις νομοθετικές εξελίξεις στην Κοινωνική Ασφάλιση προωθείται σταδιακά η εφαρμογή της ρήτρας του μηδενικού ελλείμματος και στις κύριες συντάξεις εκτός από την εφαρμογή της στις επικουρικές. Στην ασφαλιστική μεταρρύθμιση(4387/2016) διαπιστώνεται η επανάληψη των κοινωνικο-ασφαλιστικών παρεμβάσεων εισπρακτικού χαρακτήρα, η μεταβίβασης σημαντικών βαρών στις νέες γενιές των ασφαλισμένων και της επιδείνωσης του βιοτικού επιπέδου των ασφαλισμένων και των συνταξιούχων.

Προωθούνται δημοσιονομικά και εισπρακτικά μέτρα απ ότι μέτρα ασφαλιστικού χαρακτήρα τα οποία θα έπρεπε να ήταν προσανατολισμένα σε μια θετική πορεία και προοπτική του ασφαλιστικού συστήματος στη χώρα μας. Επιπρόσθετα με το νόμο 4387/2016 τα χαμηλά ποσοστά αναπλήρωσης οδηγούν στην περεταίρω μείωση των συντάξεων και την προώθηση της ιδιωτικής ασφάλισης, για τη διασφάλιση ενός ικανοποιητικού βιοτικού επιπέδου των συνταξιούχων στη χώρα μας.

Οι περιοριστικές δημοσιονομικές πολιτικές που ξεκίνησαν το 2010 από ένα μικρό αριθμό ευρωπαϊκών χωρών και βαθμιαία επεκτάθηκαν σε όλα σχεδόν τα κράτη μέλη της Ε.Ε. επιφέρουν μειώσεις κοινωνικών δαπανών και μικρές ή μεγαλύτερες αλλαγές στα συστήματα κοινωνικής προστασίας, που συρρικνώνουν τα κοινωνικά δικαιώματα των εργαζομένων και των πολιτών. Τα συνταξιοδοτικά συστήματα και τα επιδόματα ανεργίας υφίστανται στις μεγαλύτερες πιέσεις.

Κατά την σύνοδο κορυφής τον Μάρτιο του 2011 στις Βρυξέλλες, για το κοινό Σύμφωνο για το Ευρώ, καθορίζεται σαν σύστημα αξιολόγησης της βιωσιμότητας των συνταξιοδοτικών συστημάτων, ο διαρκής έλεγχος του δημογραφικού παράγοντα και του προσδόκιμου ζωής. Αυτό σημαίνει ότι εάν ένα συνταξιοδοτικό σύστημα στην Ευρωπαϊκή Ένωση δεν είναι οικονομικά βιώσιμο τότε θα πρέπει να εφαρμοστούν μέτρα όπως:

- η μείωση των συντάξεων
- η αύξηση του ορίου ηλικίας συνταξιοδότησης ή κάποιο μείγμα τους

Ήδη οι αποφάσεις αυτές, έχουν ενσωματωθεί στην νομοθεσία των κρατών-μελών, όπως και στην Ελλάδα, με χαρακτηριστική την διάταξη που ορίζει ότι οι δαπάνες συντάξεων συνολικά, δεν θα πρέπει να υπερβούν τις 2,5 ποσοστιαίες μονάδες του ΑΕΠ κατά την χρονική περίοδο 2009-2060. Αυτό θα συμβεί ακόμα και αν ο αριθμός των συνταξιούχων στην χώρα μας θα αυξηθεί κατά 70%.

## 2. Κοινωνική Πρόνοια

Ο όρος **Κράτος Πρόνοιας**, έχει επικρατήσει διεθνώς στη μεταπολεμική περίοδο, και αντιστοιχούσε στη διεύρυνση της κοινωνικής λειτουργίας του κράτους στις ανεπτυγμένες καπιταλιστικές κοινωνίες. Αποτελεί συγχρόνως αναφορά σε συγκεκριμένη ιστορική περίοδο της εξέλιξης του αστικού κράτους και ιδεολόγημα φορτισμένο με ιδέες και αξίες κοινωνικής δικαιοσύνης και αλληλεγγύης (Στασινοπούλου, 1992).

Το κράτος πρόνοιας παρέχει οικονομική ασφάλεια και κοινωνικές υπηρεσίες καθολικά, φροντίζει έμπρακτα για την αναδιανομή ενός σημαντικού τμήματος του εισοδήματος, στο οποίο έχουν κατοχυρωθεί νομικά τα κοινωνικά και εργασιακά δικαιώματα, του οποίου στόχος είναι η εξασφάλιση συνθηκών βεβαιότητας και ισότητας για το σύνολο του πληθυσμού, το οποίο θεωρείται υπεύθυνο για την εξασφάλιση των στοιχειωδών προϋποθέσεων του «ευ ζην» των πολιτών του (Ρομπόλης & Χλέτσος, 1995).

Τα συστήματα κοινωνικής πρόνοιας αποτελούν αναπόσπαστα τμήματα των «καθεστώτων ευημερίας» κάθε χώρας και ως εκ τούτου δεν μπορούν να εξεταστούν ανεξάρτητα από αυτά. Ο ρόλος και η σημασία τους εξαρτάται από την δομή, τα χαρακτηριστικά και την αποτελεσματικότητα της οικονομίας, των κρατικών πολιτικών, της αγοράς εργασίας, της οικογένειας και της κοινωνίας των πολιτών μέσα στο πλαίσιο κάθε συγκεκριμένης πολιτικής οικονομίας. Στο πλαίσιο αυτό λειτουργούν ως συστήματα «ύστατης καταφυγής», παρέχοντας προστασία στις περιπτώσεις που άτομα ή/και κοινωνικές ομάδες δεν έχουν πρόσβαση σε άλλες χρηματικές παροχές ή υπηρεσίες (κυρίως ασφαλιστικού τύπου) ή όταν οι παροχές που λαμβάνουν δεν τους επιτρέπουν μια αξιοπρεπή διαβίωση σύμφωνα με τις επικρατούσες αντιλήψεις της κοινωνίας που ζουν (Barberis, Sabatinelli, Bieri, 2010).

Η κοινωνική πρόνοια στην Ελλάδα, σε συνδυασμό με τις επιβεβλημένες διορθωτικές ενέργειες στον ευρύτερο Δημόσιο Τομέα (αξιολογήσεις, αποκρατικοποιήσεις, κλπ ) και με έναν εξωστρεφή και μη κρατικοδίαιτο ιδιωτικό τομέα, αλλά και με την δημιουργία ενός φιλικού για τις ξένες επενδύσεις πολιτικού και κοινωνικού περιβάλλοντος, φαίνεται ότι μπορεί να αποτελέσει τον τρίτο πυλώνα μίας Ελλάδας αξιόπιστης εντός της Ε.Ε. και ανταγωνιστικής στην Παγκόσμια Οικονομία.

Σύμφωνα με νέα στοιχεία του ΟΟΣΑ, οι κοινωνικές δαπάνες (συντάξεις, δαπάνες υγείας και προνοιακές μεταβιβάσεις) αυξήθηκαν από την αρχή της κρίσης στα περισσότερα κράτη-μέλη του, στην προσπάθεια των κυβερνήσεων να προστατεύσουν τους πιο αδύναμους από τις επιπτώσεις της κρίσης. Όπως παραδέχεται ο ίδιος ο ΟΟΣΑ, η Ελλάδα αποτέλεσε εξαίρεση, αφού οι κοινωνικές δαπάνες από 23,9% του ΑΕΠ το 2009 μειώθηκαν σε 22% του ΑΕΠ το 2013. Η στατιστική, όμως, δεν αποκαλύπτει το πραγματικό μέγεθος της μείωσης. Τουλάχιστον όχι με την πρώτη ματιά.

Από την αρχή της κρίσης το 2007-2008, οι κοινωνικές δαπάνες αυξήθηκαν στις χώρες-μέλη του ΟΟΣΑ, παρά το γεγονός ότι το ΑΕΠ των χωρών μειωνόταν, καθώς έμπαιναν σε περίοδο ύφεσης. Το αποτέλεσμα ήταν να αυξηθεί η αναλογία των κοινωνικών δαπανών ως ποσοστό του ΑΕΠ στο σύνολο του ΟΟΣΑ, από 19% το

2007, στο 22,1% το 2009 και στο 21,9% το 2013. Ωστόσο, στην Ελλάδα παρατηρήθηκε η μεγαλύτερη μείωση των κοινωνικών δαπανών, ως ποσοστό του ΑΕΠ, από το 23,9% το 2009 στο 22% του ΑΕΠ το 2013.

Υπάρχουν ευρωπαϊκές χώρες που επλήγησαν πολύ περισσότερο από την κρίση και οι οποίες δεν κατάφεραν να αυξήσουν τις κοινωνικές δαπάνες, για να μετριάσουν τις συνέπειες της κρίσης. Πρόκειται για την Ουγγαρία, την Ισλανδία, την Ιταλία και την Πορτογαλία. Καμία όμως δεν έφτασε το ποσοστό της μείωσης της Ελλάδας. Μπορεί κανείς να παρατηρήσει ότι στις χώρες όπου υπήρξε μεγάλη μείωση των κοινωνικών δαπανών εφαρμόστηκαν σε μεγαλύτερη ένταση οι πολιτικές λιτότητας που επέβαλαν από κοινού η Ευρωζώνη και το Διεθνές Νομισματικό Ταμείο.

Οι σφοδρές ανακατατάξεις που βιώνουν τα τελευταία χρόνια οι κοινωνίες των κρατών του Ευρωπαϊκού Νότου και η επέκταση των αποτελεσμάτων της οικονομικής κρίσης σε κάθε συνιστώσα της καθημερινότητας των πολιτών, έχουν επιφέρει ρήξη στη διαλεκτική σχέση μεταξύ κράτους και κοινωνίας.

Το κράτος πρόνοιας στην Ελλάδα συνέβαλε σε κάποιο βαθμό στην οικονομική κρίση μέσω δύο βασικών του συστημάτων: του ασφαλιστικού συστήματος και του συστήματος υγείας. Η πιο σημαντική επίπτωση που επήλθε από το ξέσπασμα της οικονομικής κρίσης στο κράτος πρόνοιας στην Ελλάδα ήταν οι μισθοί. Με μεγάλες περικοπές και με την αποδιάρθρωση των συλλογικών συμβάσεων εργασίας. Η πιο σημαντική επίπτωση που επήλθε από το ξέσπασμα της οικονομικής κρίσης στο κράτος πρόνοιας στην Ελλάδα ήταν οι μισθοί. Αρχικά, οι μεγάλες περικοπές και συρρικνώσεις που επήλθαν οφείλονται κυρίως στις υψηλές περικοπές στις αποδοχές στο δημόσιο τομέα αλλά ταυτόχρονα και στη μείωση των μισθών στον ιδιωτικό τομέα, το οποίο συσχετίζεται με την αποδιάρθρωση των συλλογικών συμβάσεων, στην εξατομίκευση των χρηματικών απολαβών, στη μετατροπή από τις εργασίες πλήρους απασχόλησης σε ευέλικτη και αντίστοιχα αδήλωτη εργασία αλλά και στη διόγκωση της φορολογίας των εισοδημάτων (INE-ΓΣΕΕ, 2010).

Σύμφωνα με τη βάση δεδομένων Ameco της Ευρωπαϊκής Επιτροπής, η μείωση των μέσω ονομαστικών αποδοχών ανά μισθωτό κατά το διάστημα 2010-2013 ανέρχεται στο -16%. Φυσικά, σε αυτή την περίπτωση πρέπει να ληφθούν υπόψιν οι μεταβολές που επήλθαν στις τιμές των καταναλωτικών ειδών που η σωρευτική αύξηση του δείκτη τιμών καταναλωτή ανήλθε για την συγκεκριμένη περίοδο στο 7%, το οποίο είχε ως συνέπεια τη σωρευτική μείωση της αγοραστικής δύναμης των μέσων αποδοχών να ανέρχεται στο 22% (INE-ΓΣΕΕ, 2013).

Ως δεύτερη και πολύ σημαντική που επήλθε στο κράτος πρόνοιας από την οικονομική κρίση είναι η πολύ υψηλή άνοδος του επιπέδου της ανεργίας. Από το Δεκέμβριο του 2008 από το 8% έφτασε στο 27% τον Δεκέμβριο του 2013 (μ.ο Ε.Ε.28:11%, μ.ο Ευρωζώνης:12%). Τα στατιστικά αυτά αποδεικνύουν ότι η Ελλάδα με διαφορά κατακτά την πρώτη θέση ως προς τα ποσοστά ανεργίας σε σύγκριση με την Ευρωζώνη αλλά και ανάμεσα στις 28 χώρες της Ευρωπαϊκής Ένωσης. Είναι σημαντικό να αναφερθεί το γεγονός ότι η κατηγορία των μακροχρόνια ανέργων ανέρχεται στο ποσοστό του 70%, ενώ η ανεργία σε ηλικίες κάτω των 25 ετών, την συγκεκριμένη χρονική περίοδο, παρουσιάζει αύξηση από το 25% στο 57%.

Οι περιοριστικές δημοσιονομικές πολιτικές που ξεκίνησαν το 2010 από ένα μικρό αριθμό ευρωπαϊκών χωρών και βαθμιαία επεκτάθηκαν σε όλα σχεδόν τα κράτη μέλη της Ε.Ε. επιφέρουν μειώσεις κοινωνικών δαπανών και μικρές ή μεγαλύτερες αλλαγές στα συστήματα κοινωνικής προστασίας, που συρρικνώνουν τα κοινωνικά δικαιώματα των εργαζομένων και των πολιτών. Τα συνταξιοδοτικά συστήματα και τα επιδόματα ανεργίας υφίστανται στις μεγαλύτερες πιέσεις. Ως αποτέλεσμα, η flexicurity – κεντρική έννοια της ΕΣΑ από τη γένεσή της – τείνει να καταστεί κενή νοήματος, σε μία συγκυρία ενίσχυσης της μονεταριστικής και νεοφιλελεύθερης ηγεμονίας και θεαματικής αύξησης της εργασιακής ανασφάλειας στην Ε.Ε (Καραμεσίνη, 2011).

Η τρέχουσα οικονομική κρίση έθεσε εξ αρχής σε δοκιμασία την πολιτική απασχόλησης της Ε.Ε., δηλαδή την Ευρωπαϊκή Στρατηγική για την Απασχόληση (ΕΣΑ). Αυτή αποδείχθηκε εντελώς ακατάλληλη για να αντιμετωπίσει την κρίση απασχόλησης στις χώρες της Ε.Ε. Λόγω της επικέντρωσής της σε πολιτικές προσφοράς εργασίας και μέτρα αύξησης της ευελιξίας της αγοράς εργασίας, η ΕΣΑ δεν είχε να προτείνει τίποτα για την αναχαίτιση της ανεργίας που προκαλούσαν οι μαζικές απολύσεις και η δραστική μείωση των προσλήψεων. Μπροστά σ' αυτήν την αδυναμία, το 2008 και το πρώτο εξάμηνο του 2009, τα Ευρωπαϊκά Συμβούλια προέτρεψαν τα κράτη μέλη της Ε.Ε. στη λήψη μέτρων αντιμετώπισης της κυκλικής ανεργίας, παρεκκλίνοντας από τις μέχρι τότε επιταγές της ΕΣΑ, που από τη στιγμή της ιστορικής της γένεσης αναγνώριζε ως μοναδικό πρόβλημα τη διαρθρωτική ανεργία και πρότεινε ως κύρια μέτρα καταπολέμησής της την προσαρμογή των δεξιοτήτων των ανέργων στις απαιτήσεις των επιχειρήσεων και την ενίσχυση της ευελιξίας της (αγοράς) εργασίας (Καραμεσίνη, 2011).

Ως προς το πρόβλημα με τους άστεγους δεν προκαλεί εντύπωση το γεγονός ότι τον Απρίλιο του 2009 οι άστεγοι ήταν λιγότεροι από 8.000 το ποσοστό εκτοξεύθηκε το 2011 με το ποσοστό να ανέρχεται στους 20.000, ενώ οι άνθρωποι που σιτίζονταν σε συσσίτια φιλανθρωπικών φορέων και υπηρεσιών στην Αθήνα και στη Θεσσαλονίκη αντίστοιχα έφτασαν τους 20.000 (Kondilis et al. 2013). Σύμφωνα με την Έκθεση της Εθνικής Αναλογιστικής Αρχής του 2018, η συνταξιοδοτική δαπάνη περιορίζεται σε 12,5% του ΑΕΠ το 2050 και σε 10,6% του ΑΕΠ το 2070, συγκλίνοντας έτσι με τον μέσο όρο της Ε.Ε.

Οι διαδοχικές μειώσεις στις κύριες συντάξεις την περίοδο 2010-2013 φτάνουν το 45% και το 2013 που καταργήθηκε η 13 η και 14η σύνταξη φτάνουν το 52% σε επίπεδο ετήσιου εισοδήματος από κύριες συντάξεις. Την περίοδο 2015-2018, στις κύριες συντάξεις οι μειώσεις έφτασαν τις 2,0 ποσοστιαίες μονάδες λόγω της παρακράτησης της εισφοράς υγείας από 4% σε 6%, στο καταβαλλόμενο ποσό της σύνταξης, και όχι στο αρχικό ποσό της.

Στην Ελλάδα για τη διατήρηση της κοινωνικής συνοχής αναπτύχθηκε σειρά παρεμβάσεων κοινωνικής πολιτικής ιδιαίτερα στον κρίσιμο τομέα αντιμετώπισης της παιδικής φτώχειας και των εύάλωτων κοινωνικών ομάδων. Ειδικότερα:

- δυνατότητα δωρεάν επανασύνδεσης και παροχής ηλεκτρικού ρεύματος καθώς και ρύθμισης των ληξιπρόθεσμων οφειλών των ωφελουμένων

- χορηγήθηκε επίδομα ενοικίου σε άτομα και νοικοκυριά που δεν έχουν τη δυνατότητα στέγασης σε ιδιόκτητο ακίνητο
- επιδότηση σίτισης μέσω προπληρωμένης τραπεζικής κάρτας
- Θεσπίστηκε το Κοινωνικό Εισοδήμα Αλληλεγγύης (ΚΕΑ) το 2017 και τη σταδιακή ενίσχυση των οικογενειακών επιδομάτων.

Στο πεδίο της κοινωνικής πρόνοιας οι μεταρρυθμίσεις που έλαβαν χώρα κατά την περίοδο της κρίσης αφορούν κυρίως:

- Την επέκταση της κάλυψης του επιδόματος της μακροχρόνιας ανεργίας και τη θεσμοθέτηση βοηθήματος ανεργίας αυτόαπασχολουμένων (Ν.4093/12).
- Την μεταρρύθμιση της δομής του συστήματος οικογενειακών επιδομάτων
- Την πλήρη εφαρμογή του Κοινωνικού Εισοδήματος Αλληλεγγύης από 1/1/2017 με στόχο την αντιμετώπιση της ακραίας φτώχειας (ΦΕΚ 128 τ.Β'/24.01.2017).
- Τη θεσμοθέτηση των Κέντρων Κοινότητας (Ν.4368/2016(ΦΕΚ 21 τ.Α) στο πλαίσιο των Οργανισμών Τοπικής Αυτοδιοίκησης α' βαθμού, με σκοπό την υποστήριξη στην εφαρμογή πολιτικών κοινωνικής προστασίας.

Ένας ακόμα παράγοντας ο οποίος ευθύνεται για την κατάσταση στην οποία περιήλθε το κράτος πρόνοιας στην Ελλάδα κατά την περίοδο της οικονομικής κρίσης ήταν ο διαμοιρασμός ενός χαμηλότατου επιδόματος κοινωνικής αλληλεγγύης. Πιο συγκεκριμένα, γίνεται αναφορά σε μια μικρή διορθωτική κίνηση με μεγαλύτερη σημειολογική αλλά και πολιτική σημασία. Αυτό το μέτρο ήταν από τα πρώτα που ακυρώθηκαν λίγους μήνες αφού ξεκίνησε η διεθνής πίεση της ΕΕ και του ΔΝΤ, έπειτα από την καταβολή της πρώτης δόσης του δανείου της διεθνούς βοήθειας. Όπως ήταν αναμενόμενο σε μια τέτοια κατάσταση κυριάρχησε η νεοφιλελεύθερη αντίληψη χωρίς όμως να υπάρξει καθόλου κοινωνική ευαισθησία (Petmesidou, 2011).

Ως προς τον τομέα της υγείας, οι νοσηλευθέντες στα δημόσια νοσοκομεία παρουσίασαν αύξηση κατά 37% κατά τα έτη 2009-2011 με μέση ετήσια αύξηση 11%, ενώ την περίοδο 2000-2008 η μέση ετήσια αύξηση ανερχόταν σε ποσοστό μόλις 2%. Την ίδια στιγμή, η προσφυγή σε υπηρεσίες δημόσιας υγείας αυξήθηκε το 2011 κατά 22% σε σχέση με το 2010 (Kondilis et al. 2013). Αυτό το οποίο προκάλεσε εντύπωση ήταν το γεγονός ότι ενώ παρατηρήθηκε αυτή η αύξηση, οι συνολικές δαπάνες για την υγεία μειώθηκαν κατά 24% ή 1,8 δις και οι δαπάνες για τα νοσοκομεία κατά 750 εκατομμύρια ευρώ ή 13%.

Η κρίση ανέδειξε στον υπερθετικό βαθμό την αναποτελεσματικότητα του ελληνικού καθεστώτος ευημερίας, συμπεριλαμβανομένου του συστήματος κοινωνικής πρόνοιας. Και παρά το γεγονός ότι οι ακραίες κοινωνικά συνθήκες που δημιουργήθηκαν έκαναν επιτακτική την ανάγκη ανάληψης πρωτοβουλιών δημόσιας πολιτικής για την «απορρόφηση των κραδασμών» που δημιούργησε η κρίση, κάτι τέτοιο δεν συνέβη. Αντίθετα, οι μεταρρυθμίσεις που δρομολογήθηκαν στο πλαίσιο εφαρμογής των μνημονιακών υποχρεώσεων της χώρας, από το 2010 και μετά, οδήγησαν στην περαιτέρω αποδόμηση ενός ήδη διάτρητου κοινωνικού δικτύου



ασφαλείας. Ενώ οι περικοπές κοινωνικών δαπανών ήταν καθολικές (υγεία, κοινωνική ασφάλιση, κοινωνική πρόνοια κλπ.) τα μέτρα για την στήριξη των πλέον ευάλωτων κοινωνικών ομάδων ήταν σποραδικά και αποσπασματικά, αδυνατώντας να αντισταθμίσουν τις τεράστιες απώλειες που προκλήθηκαν από τα μεγάλα κύματα λιτότητας (Σωτηρόπουλος, 2014). Αντίθετα, οι μεταρρυθμίσεις που δρομολογήθηκαν στο πλαίσιο εφαρμογής των μνημονιακών υποχρεώσεων της χώρας, από το 2010 και μετά, οδήγησαν στην περαιτέρω αποδόμηση ενός ήδη διάτρητου κοινωνικού δικτύου ασφαλείας.

Ενώ οι περικοπές κοινωνικών δαπανών ήταν καθολικές (υγεία, κοινωνική ασφάλιση, κοινωνική πρόνοια κλπ.) τα μέτρα για την στήριξη των πλέον ευάλωτων κοινωνικών ομάδων ήταν σποραδικά και αποσπασματικά, αδυνατώντας να αντισταθμίσουν τις τεράστιες απώλειες που προκλήθηκαν από τα μεγάλα κύματα λιτότητας.

### **Συμπεράσματα**

Η παρατεταμένη κρίση και ύφεση που μαστίζει την Ελλάδα λόγω των εφαρμοζόμενων πολιτικών τα τελευταία χρόνια, όξυνε τα προβλήματα του ΣΚΑ και επιδείνωσε ακόμη περισσότερο τη βιωσιμότητά του και τον κοινωνικό χαρακτήρα της ασφάλισης. Η δημοσιονομική πειθαρχία που εφαρμόστηκε στην Ελλάδα με την επιβολή των μνημονίων, είχε ως αποτέλεσμα της μείωσης των συντάξεων, την αύξηση των ορίων ηλικίας συνταξιοδότησης, την αλλαγή του τρόπου υπολογισμού των συντάξεων, τη μείωση των κοινωνικών επιδομάτων και τη μείωση της κρατικής χρηματοδότησης του Συστήματος Κοινωνικής Ασφάλισης.

Η εκδήλωση της κρίσης στη χώρα μας είχε ως αποτέλεσμα τη μείωση των παροχών (συντάξεις κύριες και επικουρικές, εφάπαξ, κοινωνικά επιδόματα, κλπ) και τη μείωση των κοινωνικών δαπανών με αποτέλεσμα τη σοβαρή επιδείνωση του βιοτικού επιπέδου του πληθυσμού και την άμβλυση των κοινωνικών προβλημάτων. Σε μια περίοδο δραματικής αύξησης της ανεργίας και της απορύθμισης των εργασιακών σχέσεων η κρίση του κοινωνικού κράτους και της κοινωνικής ασφάλισης γίνεται περισσότερο ορατή από κάθε άλλη φορά.

Αυτά τα οποία προκύπτουν ως συμπεράσματα κατά την περίοδο της οικονομικής κρίσης στο κράτος πρόνοιας είναι ότι αρχικά η αστική τάξη διπλασιάστηκε κάτι το οποίο δεν προκάλεσε ιδιαίτερη εντύπωση. Ένας από τους πολύ σημαντικούς λόγους για τους οποίους συνέβη αυτό ήταν κυρίως η σταδιακή από-αγροτικοποίηση της οικονομίας αλλά και η αντίστοιχη μείωση της αυτοκατανάλωσης, στοιχείο το οποίο συνέβαλε στην διεύρυνση των αμιγώς καπιταλιστικών σχέσεων παραγωγής.

Ιστορικά, το ελληνικό κράτος πρόνοιας έθετε σε μεγάλη προτεραιότητα την παροχή συντάξεων σε καλά αμειβόμενους εργαζόμενους στις αρχές της δεκαετίας του '50 (ή και νωρίτερα), αλλά έδινε πολύ λιγότερη προσοχή στην προστασία των οικογενειών χαμηλού εισοδήματος ή στο καθήκον που είχε να βοηθήσει τους νέους να βρουν απασχόληση. Η πρόσφατη συνταξιοδοτική μεταρρύθμιση έχει καταργήσει ένα τεράστιο εμπόδιο στην αναγκαία ανακατανομή των κοινωνικών δαπανών, αλλά οι ενέργειες που πρέπει να γίνουν είναι πολύ περισσότερες. Η κατάργηση των εναπομενόντων συνταξιοδοτικών προνομίων (όπως αυτά που εξακολουθούν να απολαμβάνουν οι αγρότες, τα ελεύθερα επαγγέλματα, οι στρατιωτικοί ή οι αστυνομικοί) είναι δεδομένο ότι θα αποξενώσει βασικές πολιτικές εκλογικές περιφέρειες, αλλά θα αποδεσμεύσει πόρους οι

οποίοι στη συνέχεια θα μπορούν να ανακατανεμηθούν σε μια συντονισμένη προσπάθεια ενίσχυσης του δικτύου κοινωνικής ασφάλισης (Triantafyllou, 2011) .

Η κυριαρχία του δόγματος της νέο-φιλελεύθερης λιτότητας και η επιβολή του, μέσω των μνημονίων, στην Ελλάδα κατά την περίοδο της κρίσης, έχει οδηγήσει στην περαιτέρω απορρύθμιση ενός ήδη προβληματικού καθεστώτος ευημερίας. Η συνταγή που εκτελείται οδηγεί στη συρρίκνωση της μεσαίας τάξης και στη μεταφορά πόρων από τους λιγότερο ευάλωτους στους απόλυτα φτωχούς και εξαθλιωμένους, διευρύνοντας το χάσμα μεταξύ των λίγων προνομιούχων και ενός ραγδαία αυξανόμενου αριθμού επισφαλώς εργαζόμενων, ευάλωτων, φτωχών και κοινωνικά αποκλεισμένων. Η κοινωνική πρόνοια, ως ο παραδοσιακά «φτωχός συγγενής» του συστήματος κοινωνικής προστασίας στη χώρα μας, συμμετέχει σ' αυτή την ισοπέδωση προς τα κάτω (race to the bottom), αναλαμβάνοντας το ρόλο της ενίσχυσης του εισοδήματος και της κοινωνικής κατάστασης των «ακραία φτωχών». Μια μάχη που μοιάζει εκ των προτέρων άνιση χωρίς την ριζική μεταβολή του μίγματος αναδιάρθρωσης του συνολικότερου καθεστώτος ευημερίας (Φερόνας, 2017).

## Βιβλιογραφικές Αναφορές

### Ξενόγλωσσες

- Beveridge, W. (1942). Social insurance and allied services. London: His Majesty's Stationery Office.
- Barberis, E., Sabatinelli, S. Bieri, A. (2010). Social Assistance Policy Models in Europe: A Comparative Perspective" In: Y. Kazepov (Ed.), *Rescaling Social Policies: Towards Multilevel Governance in Europe*. London: Ashgate.
- Kondilis, E., Giannakopoulos, S., Gavana, M., Ierodiakonou, I., Waltzkin, H. & Benos, A. (2013). *Economic Crisis, Restrictive Policies, and the Populations Health and Health Care: The Greek Case*. Public Health Ethics.
- Petmesidou M. (2011). Is the EU-IMF "rescue plan" dealing a blow to the Greek welfare state? *CROP Poverty Brief*, January 2011.

### Ελληνόγλωσσες

- Γενική Γραμματεία Κοινωνικών Ασφαλίσεων (Γ.Γ.Κ.Α.) (2019). Ανακτήθηκε από <http://www.ggka.gr>
- Ένωση για την υπεράσπιση της εργασίας και του κοινωνικού κράτους (ΕΝΥΠΕΚΚ) (2019). Ανακτήθηκε από: <http://www.enypekk.gr>
- Θεοδωρουλάκης, Μ. (2008). Οι εξωτερικοί παράγοντες της κρίσης της Κοινωνικής Ασφάλισης, οι επιδράσεις τους και οι εναλλακτικές πολιτικές αντιμετώπισής τους. Αθήνα: Διδακτορική Διατριβή.
- ΙΝΕ-ΓΣΕΕ (2010). *Η Ελληνική Οικονομία και η Απασχόληση. Ετήσια Έκθεση 2011*. Αθήνα: ΙΝΕ-ΓΣΕΕ.
- ΙΝΕ-ΓΣΕΕ (2013). *Η Ελληνική Οικονομία και η Απασχόληση. Ετήσια Έκθεση 2013*. Αθήνα: ΙΝΕ-ΓΣΕΕ.
- Καραμεσίνη Μ. (2011). Η πολιτική απασχόλησης της Ευρωπαϊκής Ένωσης αντιμετώπιση με την οικονομική κρίση. *Κοινωνική Πολιτική* 2: 1-17.
- Ρομπόλης, Σ., Πέτρουλας, Π., Ξυδέας, Ε. & Χλέτσος, Μ (1993). *Η κοινωνική ασφάλιση στην Ελλάδα: Η περίπτωση του Ι.Κ.Α.* Αθήνα: Παπαζήσης.
- Ρομπόλης, Σ. & Χλέτσος, Μ. (1995). *Η Κοινωνική Πολιτική μετά την Κρίση του Κράτους Πρόνοιας*. Θεσσαλονίκη: Παρατηρητής.
- Στασινοπούλου, Ο. (1992). *Κράτος Πρόνοιας*. Αθήνα: Gutenberg.
- Σωτηρόπουλος, Δ. (2014). *Η Διπλή Ανακολούθια: Οι Πολιτικές κατά της Φτώχειας και ο Πολιτικός Λόγος για τη Φτώχεια στην Ελλάδα κατά την Περίοδο της Οικονομικής Κρίσης*. Αθήνα: ΕΛΙΑΜΕΠ, Παρατηρητήριο για την Κρίση.
- Φερόνας, Α. (2017). *Η Κοινωνική Πρόνοια στην Ελλάδα της Κρίσης: Ο «φτωχός συγγενής» στη δίνη της νεοφιλελεύθερης λιτότητας*. Αθήνα: ΕΕΚΠ.

## **BOOK OF ABSTRACTS**

EU GOVERNANCE & LEADERSHIP

SUSTAINABLE DEVELOPMENT, ENVIRONMENTAL AND ENERGY POLITICS

HEALTH: POLITICS AND POLICIES

GOVERNANCE AND POLITICS IN GREECE

REGIONAL DEVELOPMENT AND GOVERNANCE IN THE EU AND GREECE

EU DEFENCE AND INTERNATIONAL SECURITY

MIGRATION – REFUGEE CRISIS AND EU POLICIES

HEALTHCARE POLICIES

ISSUES OF ENERGY AND SUSTAINABLE DEVELOPMENT

MEDIA AND THE DIGITAL ERA

EU INTEGRATION, POLITICS AND GOVERNANCE ISSUES

INTERNATIONAL RELATIONS, DIPLOMACY AND GEOPOLITICS

PUBLIC POLICIES IN EDUCATION, HIGHER EDUCATION & TRAINING

PUBLIC ADMINISTRATION, POLICY-MAKING AND GOVERNANCE

FINANCE AND INVESTMENTS

POLITICAL ORIENTATION, POPULISM AND EUROSCEPTICISM

ISSUES OF EDUCATION POLICY AND SOCIAL COHESION

**EU GOVERNANCE & LEADERSHIP**

## The feeling of "Democratic deficit" in the European Union

*Panagiotis Liargovas<sup>1</sup>, Christos Papageorgiou<sup>2</sup>*

<sup>1</sup>Professor of Department of Economics, University of Peloponnese, Tripolis, Greece

<sup>2</sup>PhD cand., Department of Economics, University of Peloponnese, Tripolis, Greece

### ABSTRACT

The sense of democratic deficit within the EU is a result of the prevailing view that EU governance lacks democratic legitimacy. Reports of a democratic deficit are growing, especially in times of economic or political crisis and uncertainty. In practice, the concept of democratic deficit expresses the distancing of EU institutions and decision-making centres from the citizens of the member states, while represents the functional distortions of its institutions, which become inaccessible to the average citizen, as their mode of operation is particularly complicated.

The views of many researchers differ on the existence and the type of the democratic deficit in the EU. Some of them, especially those who support intergovernmental cooperation, refuse its existence. Federalists argue that its institutions need to be reformed to achieve the required democratic legitimacy and functional transparency, with the consent of the citizens of the member states, leading in a form of federation. Eurosceptics argue that EE should reduce its arbitrary powers, which deprive the member states and their citizens of the ability of independent democratic functioning.

In the present work, an attempt is made to clarify the term, according to the different approaches for the way of legitimizing the EU political system, i.e. from the *procedures* (from the *inputs*) or from the obtained *results* (from the *outputs*), while the *socio-psychological dimension* of the issue is also investigated, which refers to the existence or not of a common *European identity*, and consequently to the possibility of the existence of a *European Municipality*. Furthermore, reference is made to the concept of "*Europeanization*", and its positive contribution to the creation of the aforementioned European unity.

It also explores in detail the sense of a democratic deficit in the EU, as reflected in the Eurobarometer, that is, whether European citizens believe they are satisfied with the level of democratic functioning of the EU and whether they feel they belong to a single European municipality. Finally, their interest in the functioning of the EU is being explored through their participation in the European elections, as well as their reactions through referendums for the ratification of treaties or their remain in the EU, while some explanations are provided for their stance, and finally, the obligation of European institutions is emphasized, in order to make European citizen informed in a timely and transparent manner.

**Keywords:** Democratic Deficit, European Union, European Municipality, Europeanization

## **On the European tug-of-war between Democracy and Technocracy**

*Sotiris Mitralaxis<sup>1</sup>*

<sup>1</sup>Teaching Fellow — University of Athens, Research Fellow — University of Winchester

### **Abstract**

A dominant feature of European politics during the last few years, at the very least, is a tug-of-war between democracy and technocracy: the dilemma between what the popular vote dictates and what "should" be done on the basis of any given number of criteria. From the handling of Greece's financial crisis, where austerity was rejected by the popular vote both in the case of national elections and in a referendum, with the very government that introduced it overturning its mandate, to Brexit, in which the popular vote dictated political choices quite distinct from what is deemed to be "sensible" by technocracy in the UK and overseas, which in turn is reflected in the House of Commons' reluctance to decide on the proper strategy for Brexit, this tug-of-war emerges as a central feature in the European Union's current conduct and predicament. Diagnostics aside, this paper will attempt to rethink what this dilemma entails for the feature of Europe as a whole and as an aggregate of member-states and nations.

**Keywords:** European politics, Technocracy, Democracy.

**SUSTAINABLE DEVELOPMENT, ENVIRONMENTAL**  
**AND ENERGY POLITICS**

## **Sustainable Development and the European Union: From Policy Making in the Field of Application**

*Dr Zoe Karanikola<sup>1</sup>, Dr Georgios Panagiotopoulos<sup>2</sup>*

<sup>1</sup>University Of Patras, Greece

<sup>2</sup>University Of Patras, Greece

### **Abstract**

The particular societal characteristics of our time, the rapid technological developments and the strong demographic changes create the need to formulate and implement supranational policies that aim at the well-being of citizens. The development of human beings and the maintenance of a decent standard of living is a key issue for the world community but also a continuing historical challenge. In this historic challenge, the UN has played a special role starting with the Universal Declaration of Human Rights in 1948. This text has been the basis for drafting many others, including the Millennium Development Goals (2000-2015) and the Agenda 2030 - Sustainable Development Goals (2015-2030). Sustainable development is a process of constant change and adaptation in order to meet the needs of both the present and future generation through a balanced and equitable pursuit of economic growth, environmental protection and social cohesion. The European Union (EU) has a long history of policymaking regarding the development and prosperity of societies. The Treaty of Maastricht (1992) has set the precondition for the EU to improve the cohesion of all European policies with a view to development, while the Treaty of Lisbon (2009) states that the Union should take into account that cohesion and Synergies of its policies that can affect developing countries. The present study, through the qualitative analysis of two EU texts (2016), the “Key European action supporting the 2030 Agenda and the Sustainable Development Goals” and the “Proposals for a new European Consensus on Development. Our World, our Dignity, our Future” comes to illustrate and explore the way the EU can contribute to achieving the Agenda's goals. The analysis of the text reveals that the policy-making, a key feature of which is cohesion, investment in education, the acquisition of right skills and the protection of human rights can contribute towards this direction.

**Keywords:** European Union, Agenda 2030, policies, education, human rights.



## EU Normative Power and the IMO: Internal and External Climate Diplomacy

*George Dikaios*<sup>1</sup>

<sup>1</sup>Department of Political Science and Public Administration, National and Kapodistrian University of Athens, Greece

### Abstract

In April 2018, the International Maritime Organization (IMO) adopted the ambitious *Initial Strategy on reduction of greenhouse gas emissions from ships* (Initial Strategy). For the European Union's (EU) Transport Commissioner, this was an example of successful EU influence on the IMO (Bulc 2018), in line with the EU claims to be a normative power in the international climate negotiations. This paper proposes the exploration of this influence through the application of the theoretical approach of 'normative power Europe' (Manners 2002) to identify the ways EU norms are exerted at the international level. The question that the paper seeks to answer is: In what way did the EU perform as a normative power and influenced the IMO to adopt the Initial Strategy? The analysis is divided into two main parts, focusing on this specific case-study: the pressures by the EU to its member-states to adopt a common negotiation strategy; and, the influence exerted on the IMO to adopt an ambitious climate change policy. Both these aspects are essential in order for a strong EU norm to be diffused at the international level. This case is of particular interest for the discussion of EU internal coordination and the implications stemming from the EU competence issue of who is representing the EU in the IMO. The reason is that the European Commission only has an observer status in the IMO and, therefore, only the EU member-states may officially speak during IMO meetings and negotiations. While this gives the member-states the opportunity to diverge from the EU position, in the case under examination, although some EU member-states interests were contrary to what the EU institutions wished to advocate, they eventually supported the adoption of the Initial Strategy. The empirical data that are analyzed include secondary literature on institutional relations between EU and IMO, official documents and 22 interviews with key stakeholders. The paper concludes that EU climate norm diffusion in this specific case was successfully achieved, both internally and externally, and it signposts the ability of the EU to significantly influence the adoption of international climate regulation, a fact that is often under contestation.

**Keywords:** EU, IMO, Normative Power, Climate Diplomacy, Internal Coordination

**HEALTH: POLITICS AND POLICIES**

## Congo: Political Factors Leading to Incompetence in Facing Ebola Outbreak

*Antonia – Nefeli Karaleka<sup>1</sup>*

<sup>1</sup>Double major undergraduate student,  
Faculty of Political Sciences and Public Administration, National and Kapodistrian University of Athens, School of Business and Economics, Faculty of Management, Deree - American College of Greece

### Abstract

The Democratic Republic of Congo is currently one of the most well-discussed issues in the global agenda. The aim of this paper is to underline the political factors which led to it; a crucial Ebola outbreak impossible to be handled due to the political instability. As it is a currently running situation, this paper becomes more difficult, yet crucial at a global level. It consists an effort to approach this issue by understanding the History of Congo and creating expectations for the future.

Even though, the country had a lot of chances to get on the top of highest priority discussions, the final hit was made on July 17<sup>th</sup>, when the World Health Organization declared that the current Ebola outbreak in Congo is a global health emergency. These numbers increase the interest of foreign forces making United Nations to send health workers to support the elimination of Ebola in Congo. However, is Ebola the only enemy Congo has to face?

The reaction of local people was beyond any expectation; health workers arrived in Congo are faced with distrust, armed groups attacked and destroyed medical centers where infected people were recovering and on the top of all that, 40% of local population claim that Ebola outbreak is just a political Myth to control masses. Global society was, at first point, relieved when after 18 years in a row, Congo has changed to a new president, Felix Tshisekedi.

At the same time, learning that his election was decided into closed doors with his predecessor, Joseph Kabila, global donors, to whom the vast majority of Ebola fight was based, are refusing to support such a state. Tshisekedi until now has shown great signs of evolution in comparison to his predecessor though by releasing political prisoners.

However, if the reform which Mr. Tshisekedi promised is real, he should start working on creating a business-friendly country. This is because only under these circumstances foreign investors and donors will be interested towards Congo. The country needs their technical and monetary support to face Ebola but to acquire it, it has to show immediately signs of solvency and political stability.

**Keywords:** Congo, Ebola, political crisis, Kabila, Tshisekedi

## **Bioterrorism as a Public Health Challenge:**

### **Promise vs. Performance**

*Charalampos (Harry) Tsiamitas,<sup>1,2</sup> Tina Garani – Papadatos<sup>2</sup> and Anastasia Barbounis<sup>2</sup>*

<sup>1</sup>Department of Public Health, Faculty of Medicine & Surgery, University of Malta, Malta.

<sup>2</sup>Department of Public Health Policy, School of Public Health, University of West Attica, Greece.

#### **Abstract**

The purpose of the present study was to evaluate the challenge that bioterrorism poses within the Public Health policy context and its bioethics dimension in Greece. The challenge for Public Health policies in Greece aiming at the prevention of bioterrorism incidents will be of interest to the authors. The challenge consists of historical, legislative, bioethical, health outcome, Public Health policy and strategic planning content as presented.

An attempt is done, focusing on the investigation of the current scientific and legislative framework in Greece as compared to European practices and the bioethical dimension. This study makes use of both qualitative and quantitative methods. These include content analysis and document-based research as well as descriptive and inferential statistics. It includes a bibliographic review of the International, European and National legal framework apart from peer reviews on the bioethical dimension of bioterrorism preparedness. After the case study of Greece, presenting opinions and legislative frameworks that emerged from our research, we discuss the results and propose solutions.

The study suggests that bioterrorism challenge and its bioethical extension is an important research area for Public Health leadership and practice in the realm of National, European and International policies that should be investigated furthermore.

**Keywords:** Bioterrorism, Public Health, Bioethics, European Policy

**GOVERNANCE AND POLITICS IN GREECE**

## **Crisis in Greece: A Theoretical Discussion on Domestic Actors and Reform Environment**

*Nüve Yazgan*<sup>1</sup>

<sup>1</sup>PhD Candidate at University of Surrey, UK.

### **Abstract**

This paper aims to explain the role of domestic policy environment in reform implementation process in Greece during the austerity. Greece had been in the cycle of reform from 2010 until August 2018 with three adjustment programs. Greece's hardships on implementing its programs had led to discussions on the design of the reform programs as well as the reform capacity in the country. This paper asks: how the domestic reform environment affected the policy implementation process? It aims to provide an integrated theoretical approach combining several elements from the Advocacy Coalition Framework (ACF) and the Narrative Policy Framework (NPF). I argue that ACF and NPF can be useful to explain the process that led to tumultuous implementation of the three memoranda. The pro-memorandum coalition emerged weak in Greece which was doomed to fall apart in short time, failed to follow effective narrative strategies. The anti-memorandum coalition and its belief system, however, emerged stronger with use of effective narrative strategies. These had led to lack of wider social and political consensus on the necessity of reforms at the initial phase of the crisis and paved the way for continuous cycle of disarray and two more memoranda.

**Keywords:** Austerity, Crisis, Greece, Reform

## **The party system in crisis. From the ideological context to the memorandum / anti-memorandum discourse**

*Konstantina Kotsiopolou*<sup>1</sup>

<sup>1</sup>PhD candidate at the University of Athens, Greece

### **Abstract**

The present paper aims to present the changes noticed in the pre-election programs of the parties from 1974 to 2015, a period characterized by radical changes in the political life of Greece. For many years, the party system was based on the traditional separation of the ideological axis "Left / Right". In the pre-election programs parties were gradually showing a clear ideological position and, respectively, the voters identified with a specific party. This ideological vote prevailed for several years, until the first timid shifts of the parties in the axis, but replaced much later - at the beginning of the economic crisis in Greece - by the punitive vote. During the turbulent period starting from 2009, the party system changes radically, new parties appear in the parliamentary scene, economic stability is the main priority, key areas are set aside and the voters show strong tendencies of disapproval towards the new structured party system.

This paper attempts to make a comparative analysis of the parties' announcements in relation to the respective requirements of the memoranda. In this context, key conclusions are expected to be drawn on how the parties, from shaping their programs based on the ideology they advocated, were now forced to structure their program based on the Memorandum-Anti-Memorandum dipole.

**Keywords:** Party System, Pre-Election Programs, Memorandum-Anti-Memorandum

## Public governance and the management of wicked public problems

*Dr. Maria Rammata*<sup>1</sup>

<sup>1</sup> Independent Public Administration Expert, Teaching Staff at the Hellenic Open University and at the University of Macedonia

### Abstract

Wicked problems are increasing in Intensity and frequency attracting more and more the interest of national and international public governance, causing embarrassment or even impasse to Governments. This paper presents a detailed overview of the dimensions of “wicked” problems, their position in modern governance and the possible scenarios of managing them. The following practices are proposed so as to tame wicked problems : a) The authoritarian, competitive and collaborative process, b) The small wins (Incrementalism), c) the three phases of approach: Recognition, Development, Selection, and 4) Collaborative and Network Governance. The above mentioned practices attempt to develop the ability to manage these problems smoothly so as not to harm the political-administrative system.

**Key words:** governance, wicked problems, small wins – incrementalism, collaborative governance, stakeholders

## Organizational size and IT innovation adoption: A scrutiny of the relationship between size and e-Government maturity in Greek municipalities, through a citizen/service-oriented maturity model.

*Michail Tsafantakis*<sup>1</sup>

<sup>1</sup>Leiden University, Faculty of Governance and Global Affairs, MSc. in Public Administration, the Netherlands

### Abstract

This study shed light on the relationship between organizational size and e-Government maturity, through the scrutiny of Greek local governments’ effort to deliver public value via IT innovation. Having taken into consideration the urgent need for e-Government maturity models which demonstrate an explicit focus, the stage model themes Lee (2010) identified, and the remark by Andersen and Henriksen (2006) about the major importance of the customer perspective in e-Government strategic thinking, we proposed an innovative maturity model with an explicit focus on the citizen/service theme. The proposed maturity model consists of 7 developmental phases (*Web presence, Two-way communication, Service & financial transaction, Participation, Personalization, Collaboration, e-Governance*). Through the aforementioned model, this study initially identified the e-Government maturity of all the Greek municipalities and subsequently, scrutinized its relationship with organizational size. Our findings revealed that higher number of permanent municipal employees is associated to higher possibility for the phases of “Service & financial transaction”, “Participation”, “Personalization” and “Collaboration” to be materialized. Furthermore, we concluded that an increase of 1 permanent municipal employee would increase the odds of materialization of “Two-way communication”, “Service & financial transaction”, “Participation” and “Collaboration” by 7.7%, 28%, 2.6% and 1.2% respectively.

**Keywords:** e-Government, organizational size, municipalities, IT innovation

## **Digital Barometer for Public Org's and Agencies**

*Dimitris. I. Panopoulos*

### **Abstract**

International academic, public and private research organizations recognize a gradually increasing exponential process of digitization and automation of many forms, and functions of states and the labor market. Digital transformation is one of the four global trends along with globalization, demographic aging, and migration flows / free and global human resource mobility. A key sector, drastically changing along with the advent of digital and exponential technologies is the labor market. Its basic dimensions (labor force, business ecosystem, Social Insurance Organizations,, government agencies, third social sector, professional branches and professions, vocational training systems, imbalances between labor supply and demand, mismatches) of various types, etc, are rapidly reshaping and becoming increasingly complex and intercorrelated and thus pose enormous challenges for all developed and underdeveloped countries. Digitization has a huge impact on every job, as almost all of them have internal actions and stages that can be automated.

Scientific criteria for measuring the feasibility of automating a job include: proportion of repetitive actions within working time, degree of importance, complexity of a job, mental effort or the use of logical connections, etc. International research showcase differentiations in the degree of job loss (due to the different focus and weight of influence given to quantitative and qualitative terms of the effect of automation / digitization on jobs), however scientific views converge on the type of digital skills-professions required -branches-environments of the future.

While there is a series of surveys that study the phenomenon at international / European level, or at the micro-sample level of EU MS, with a different methodology each time, Greece does not have a structured, extensive, organized, quantitative and qualitative, time-consistent research methodology or tool that studies in depth the above effects of the digital transformation on the Public Organizations and Services of the country here is a lack of a scientific, research, digital tool that processes data from various sources and metadata, to lead in a reliable way to draw conclusions, strategic directions, realistic forecasts and proposals to the relevant entities. There is no permanent university, administrative / national database that will consolidate the above, data and metadata, from already existing Information Systems of the greek State such as the Diagnostic Mechanism of the Ministry of Labor, I.S ERGNI, I.S. ELSTAT, I.S. G.E.M.I., Market etc. Intelligence (LMI) and other data from commercial Chambers. The new reality, especially within pandemics, imposes "functional plasticity" of Public Organizations, a constant alternative of continous transformation and lifelong learning and change.

The Digital Adaptability / Digital Performance Barometer of Public Organizations and Bodies aims to cover all the shortcomings, the infamous integrated methodological environment of primary research (with the creation of a corresponding I.S. afterwards) and the creation of a common space for comparison / processing of all available administrative and scientific data.

**Keywords:** Digital Transformation, Digital Barometer, Adaptation / Digital Performance of Public Organizations.



**REGIONAL DEVELOPMENT AND GOVERNANCE IN THE EU AND GREECE**

## **Regional Governance and Modularized Reskilling Towards Policy Improvement: The Case of the Research Project “Governance, Sustainability and Regional Innovation” (KA 4289)**

*Maria Drakaki<sup>1</sup>, Stylianos Ioannis Tzagkarakis<sup>2</sup>, Apostolos Kamekis<sup>3</sup>, Kostas A. Lavdas<sup>4</sup>, Dimitrios Kotroyannos<sup>5</sup>, Nikos Papadakis<sup>6</sup>*

<sup>1</sup> Dr. of the Department of Political Science of the University of Crete, Researcher of the Centre for Political Research and Documentation (KEPET), Department of Political Science, University of Crete, Greece

<sup>2</sup> Dr. and Postdoctoral Researcher of the Department of Political Science and , Researcher of the Centre for Human Rights (KEADIK), Department of Political Science, University of Crete, Greece

<sup>3</sup> Dr. of the School of Medicine, University of Crete, Researcher of the Centre for Human Rights (KEADIK), Department of Political Science, University of Crete, Greece

<sup>4</sup> Professor at the Department of International, European and Area Studies , Panteion University of Athens , Deputy Director of the Centre for Political Research and Documentation (KEPET), Department of Political Science, University of Crete, Greece

<sup>5</sup> Professor and Director of the Centre for Human Rights (KEADIK), Department of Political Science, University of Crete, Greece

<sup>6</sup> Professor and Director of the Centre for Political Research and Documentation (KEPET), Department of Political Science, University of Crete, Deputy Director of the Center for Research & Studies in Humanities, Social Sciences & Pedagogics (CRS) of the University of Crete, Greece

### **Abstract**

This study deals with the targeted-modularized Training-Reskilling Programme for the Local Government Executives of the Region of Crete, which was designed and implemented based on both the quantitative and qualitative findings of the needs assessment within the framework of the Research Project entitled “Governance, Sustainability and Regional Innovation” (KA 4289) in Crete. The primary aim of the Training-Reskilling Programme was the capacity building among the Local Government Executives and staff and subsequently, its positive contribution to policy improvement. Therefore, this study analyses briefly the theoretical dimensions and the key components of the multi-parametric relation between governance, sustainability and regional development, focusing on the key role of reskilling in the development of Local Government human resources towards the improvement of regional governance. In the second part, the analysis will specifically focus on the methodological strategy, which was designed and used for the implementation of the Field Study of the Research Project, emphasizing on the primary qualitative research of the Project. Namely, the needs assessment and its key research findings, based on which the Training-Reskilling Programme for the Local Government Executives and staff that was designed and implemented. Accordingly, the framework, the outline, the modules, the teaching methods and the evaluation process of the Training-Reskilling Programme are presented and analyzed. The study concludes with a broader set of evidence-based proposals related to the processes of reskilling and capacity building of the Local Government structures’ human resources.

**Keywords:** Governance; Needs Assessment; Reskilling; Human Resources; Region of Crete

**EU DEFENCE AND INTERNATIONAL SECURITY**

## **The Security Challenges that the EU is Facing in Cyberspace**

*Mrs. Eleni Kapsokoli<sup>1</sup>*

<sup>1</sup>PhD Candidate, Department of International & European Studies, University of Piraeus, School of Economics, Business and International Studies, Laboratory of Intelligence and Cyber-Security

### **Abstract**

The EU is a federation of states where the primary purpose is the freedom and security of its member-states through the use of political, economic and military means. The EU must address traditional and new threats that derive from state and non-state actors. Hybrid warfare, illegal migration, organized crime and cyberterrorism are only some of the security challenges that the EU is facing nowadays. The rapid development of Information and Communication Technologies (ICTs) in the early 21<sup>st</sup> century, has offered countless possibilities for the collection, processing, dissemination and exchange of information, overcoming to a great extent the geographical boundaries. These conditions have affected almost every aspect of our lives and thereby create new risks, since there are 4.3 billion internet users in 2019. Cyberspace is a rapidly changing domain and therefore, the EU needs to address these threats and adopt a common effective security and defense strategy. Cyber-attacks are threatening not only ICTs, which are a key objective, but also target our political and human rights. Over the last few years, the EU has recognized the growing threats that arise from the nature of our digital world, which depends on automation and connection to data. Thus, the EU has assumed cyber security responsibility for its member-states with an integrated cyber-security strategy that will strengthen the principle of resilience, mitigate cyber threats and explore all the benefits of digital transformation. In September 2017, the EU updated the Cyber Security Strategy, which intends to improve the protection of vital EU infrastructure. However, the new strategy leaves open a series of questions about how its target for an "open and secure cyberspace" will defend reliably, both internally and externally. The EU has not sufficiently defined its resilience or deterrence, nor how it intends to overcome the institutional fragmentation and lack of legal authority on cybersecurity issues. This paper explores how the EU is approaching cyber security. Firstly, it reflects the challenge of defining cybersecurity by the European Union. It also tries to map security and defense threats in the cyberspace, which are pushing the EU to develop an effective strategy. It then analyzes the main capabilities and frameworks of the instruments in the field of security and defense. Finally, some predictions are made of future actions by the EU in cooperation with other organizations to tackle cyber challenges more effectively.

**Keywords:** EU, Cybersecurity, ENISA, NIS

**MIGRATION – REFUGEE CRISIS AND EU POLICIES**

**Addressing the Needs of Migrant Mothers for Learning Greek as an  
Additional Language through School-Based Actions:  
Lessons Learned from EU Funded Initiatives**

*Elena Xenit<sup>1</sup>*

<sup>1</sup>CARDET – Centre for the Advancement and Development of Educational Technology  
AUTH – Aristotle University of Thessaloniki

**Abstract**

This contribution describes efforts to address the need for mothers of migration biography to learn Greek through needs-based initiatives designed and implemented in the context of European funded projects. These personalized efforts have the form of school activities implemented in the schools where their children enroll.

In an age of intense challenges, school actions are presented as a good practice in addressing the needs arising from the constant changes and challenges in modern societies (which have an impact on the modern school and beyond) and propose problem-solving strategies, continuous development and improvement. Designed to meet the needs of mothers of a migration background, such as language, personal and professional empowerment, well-being, etc., and focused on good integration practices, these school initiatives work against inequality, as well as the gaps and challenges that the modern school, society and world face, and seek a place among the best integration initiatives in the current time and sustainable-wise.

These school actions are research- and documentation-oriented, identifying and examining needs, planning actions and making implementations, based on identified needs, involving mothers in all processes (development, reflection, review and evaluation, dissemination and exploitation, etc.), giving space to their voices, needs, abilities, talents and visions, helping them meet the challenges they face on the path to inclusion (e.g. language) and event enabling them to become leaders of their own (and others') integration. At the same time, these school-based (and beyond) initiatives emphasize the need for the modern school to examine and adopt personalized integration initiatives, aimed at the mother (and families) of a migration biography, providing opportunities and grounds.

**Keywords:** women migration integration good practices, migrant needs-based initiatives, Greek as an additional language for migrants, school-based actions

**‘CEAS before the Courts – from interpretation to standard setting’**

**Reflections on the Judicialization of asylum protection and the role of courts in law development**

*Maria Papaioannou<sup>1</sup>*

<sup>1</sup>Information and Analysis Officer, EASO; PhD International Law; Diploma in Human Rights Law of the Academy of European Law (European University Institute)

**Abstract**

Only in 2017, the CJEU issued 14 judgements on asylum cases while another 26 were still pending. Numbers are similar in ECHR for asylum related cases. Although ECHR is not part of the EU asylum legal framework it impacts indirectly but still significantly CEAS implementation, as it de facto reviews asylum policies or implemented procedures based on a human rights perspective e.g. detention, expulsions etc. At the same time, national courts remain actively engaged in CEAS interpretation.

In this context, access to asylum procedures and Dublin cases remain critical according case law practice. The *MSS v. Greece* case, for instance, affected tremendously the Dublin Acquis. Despite the European Commission Recommendation of 8th of December 2016, in order to transfer non-vulnerable applicants who had entered the Greek territory from the 15th of March 2017 onwards, national courts have ruled on many occasions against resumption (e.g. Administrative Court of Düsseldorf ruled in case 12 L 4591/17 A). Similarly, Dublin transfers have been suspended (e.g. AT, Constitutional Court (VfGH) 28.07.2016, E449 / 2016 et al; UK, of *Ibrahimi and Abasi vs The Secretary of State*; ECHR, *Tarakhel v Switzerland*). European policies such as the relocation scheme and the EU-Turkey Statement have been questioned in European and national courts.

Based on the increasing jurisprudence, this paper discusses the judicialization of European asylum protection and its impact on redefining EU standards and streamlining procedures. It further seeks to identify trends and the increasing influence of juridical texts and actors on implementing asylum policies: do courts guarantee and still expand refugee protection? Is the ECtHR’s agenda and approach restricting EU MS discretion or redefining EU policies and standards?

Aiming to address these questions, the author will draw on insights from debates around judicialization to explain the intertwined legal and political processes emerging in the realm of state borders in shaping EU policies. A qualitative content analysis of selected decisions issued in 2017-19 will shed light on the impact of case law on CEAS implementation as well potential implications on CEAS reform.

**Keywords:** (asylum; refugees; CEAS; courts; jurisprudence)

## **Parents' Mobilizations During the Refugee Crisis**

*Maria Siamaga<sup>1</sup>, George Siakas<sup>2</sup>*

<sup>1</sup> PhD Candidate, University of Macedonia, Greece

<sup>2</sup> Research Director at the Public Opinion Research Unit, University of Macedonia Research Institute, Greece

### **Abstract**

Since 2010, Greece has gone through a deep crisis with an important social impact. This crisis initially appeared as a fiscal one, but it quickly evolved, leading to major political implications. Mainly due to the Syrian Civil War, Greece became the first gate into the EU for millions of migrants. The Dublin III Regulation, under which migrants should apply for asylum in the first EU state they enter, has led to EU external border States to bear the brunt of migrant arrivals. As a consequence, Greece faced a chronic overcrowding. Especially, as the asylum process is running at a slow pace, Greek islands such as Lesbos, Chios and Samos, were overloaded.

As a response, hosting centers and hot spots in various areas throughout the country were created. This caused turbulence within the local communities. Especially the government's effort, which started in 2016, to incorporate the immigrants and refugees into the local societies by placing their children aged 6-15, into the public schooling system, has triggered a period of high mobility.

This project aims to investigate actions and reactions of the Parents' Associations in six primary schools in four different areas, Oreokastro, Profitis, Philippiada and Samos. We are particularly interested in exploring what brought parents of different political views, educational levels, and statuses, together. What triggered these mobilizations, and whether the perceived goal was achieved. We also want to see how homogenous the mobilizations were, how they evolved through time and what kind of local support they received.

Methodologically, we have conducted a cross-sectional survey poll, fielding a representative sample from the population of an urban area (Oraiokastro) and from an island (Samos island). The findings of this poll will be enriched by findings from the semi-structured interviews of participants or bystanders of the parents' movement mobilizations. Semi-structure interviews' sampling units will be selected by convenience and/or snowball sampling.

**Keywords:** Refugee Crisis, Social Movements, Mobilization, Collective Action, Public Opinion



## The Changing Face of the Common European Asylum System: The Uncertain Future and Challenges for Refugees Integration in the European Union.

*Sibusisiwe Bulala Kelly*<sup>1</sup>

<sup>1</sup>PhD Candidate European Law and Governance School (ELGS) Greece.

### Abstract

Integration of immigrants has been the top priority for the European Union (EU) since the 1990s the Common European Asylum System (CEAS) was proposed in 1999 and adopted in 2004. However, in the specific case of refugees' integration there is no explicit EU policy and their integration is based on the Qualification Directive 2011. Following the migration pressure in 2015 that resulted in a poor response from the EU, it was clear that the need for consistent and clear policies was imperative. This paper draws from the continuing comparative theoretical investigation carried out between Greece and Ireland, on the challenges of integrating refugees as guided by the (CEAS). Acknowledging that not all asylum seekers become refugees the question is, at what stage should integration process start? The theoretical reflections will focus on difficulties in accessing asylum and integration complexities in areas of employment, formal education, health and social care. Also, recognising that CEAS was created to harmonise the asylum system among the EU Member States in order to prevent asylum seekers from reaching countries with attractive asylum and integration systems. However, findings based on literature review have shown that due to deficiencies of Dublin regulation and EU Turkey Statement some EU Member States have taken an opportunity to exploit the weaknesses of these policies. The consequences of these policies have facilitated the shift from curtailing asylum seekers searching for favourable asylum system within the EU to the promotion of a strategy that allows the EU Member States to choose asylum seekers deemed with most attractive characteristics and skills that suit the host country. Not only is this move considered morally wrong by advocates of refugee integration schemes but it is also violating the international law of refugees' protection and undermining already compromised CEAS that have a greater potential of causing severe damage to the EU values and reputation. Thus, lack of political will, solidarity and unfair share of responsibilities endure among the EU Member States. Equally, the fates of asylum seekers continue to plunge into a continuous state of limbo/immobility with no clear direction and hope for their future. Managed effectively, the integration of refugees could be vital to the future well-being, prosperity and strength of EU societies.

**Keywords:** (Refugees, Asylum-seekers, Integration, Complexities, Common European Asylum System)

## Revisiting EU Immigration and Asylum Law Through Global Constitutionalism Theory

*Danai-Georgia Koutsopoulou*<sup>1</sup>

<sup>1</sup>LL.M., Ph.D. Candidate at the University of Hamburg

### Abstract

This proposal originates from the connotations of assorted prevailing hurdles towards an effective and coherent Immigration and Asylum Law system within the European Union given that the EU has constantly stressed its commitment to offering international protection to people fleeing wars and persecutions in accordance with international refugee law. It describes the constitutional nature of human rights protection and their prevalence in international law as to revisit it within the precise field of Immigration and Asylum Law. On the one hand, bearing in mind the need for global commitment therein, for determinative purposes, a framing of the multi-level regulatory framework on the issue employing several classic and contemporary conceptions in terms of the policy, and the most relevant case-law of the Court of Justice is crucial. Therefore, the project aims to underline the global dimension of the Union's engagement, and its historical opportunity to emerge as a sustainable consistent body and a dominant actor capable of confronting the current challenges for the sake of its external competences' compliance to the declared values of the Treaties and the *ius cogens*. On the other hand, the research embracing aspirations towards a further harmonious assortment of rules on the subject, explains why the latter shall be considered as bringing a brand-new era of constitutionalism in the EU. It follows that the endeavor conduces not only to wield the compelling contemporary calls but also to formulate a sustainable future promptly in the core of the historical lessons of division and conflict between the Member States. In that respect, it is reiterated that there is a need to incorporate and reflect on the human rights users' voices for a socially coherent and viable prospect of solidarity and mutual respect horizontally and vertically.

**Keywords:** global constitutionalism, Immigration and Asylum policy, human rights, Treaty values.

## Refugees' social and economic integration prospects in Greece: A case study in Lesvos and Crete islands

*Dimitrios Kotroyannos<sup>1</sup>, Stylianos Ioannis Tzagkarakis<sup>2</sup>, Apostolos Kamekis<sup>3</sup>,  
Georgia Dimari<sup>4</sup> and Emmanouil Mavrozacharakis<sup>5</sup>*

<sup>1</sup>Professor and Director of the Centre for Human Rights (KEADIK), Department of Political Science, University of Crete, Greece

<sup>2</sup>PhD, Postdoctoral researcher of the Centre for Human Rights (KEADIK), Department of Political Science, University of Crete

<sup>3</sup>PhD, Researcher of the Centre for Human Rights (KEADIK), Department of Political Science, University of Crete, Greece

<sup>4</sup>PhD Candidate, researcher of the Centre for Human Rights (KEADIK), Department of Political Science, University of Crete, Greece

<sup>5</sup>PhD Candidate, researcher of the Centre for Human Rights (KEADIK), Department of Political Science, University of Crete, Greece

### Abstract

After 2015, the refugee crisis in Greece became one of the main challenges for policymakers both in terms of immediate measures in order to protect refugees at “hot spots” as well as of their prospects, interventions, actions and policies for their effective integration into the socio-economic system. This research analyses these perspectives and illustrates the difficulties faced by refugees, which prevent them from a rapid integration process as well as the necessary interventions in order to address these issues. Therefore, a triangular research strategy, including both qualitative and quantitative methods, was carried out in order to investigate the difficulties that refugees encounter, the dimensions of their human and social capital as well as the prospects, attitudes, shortcomings and barriers of the labor market which affect their socio-economic integration. The field research was conducted in Crete and Lesvos islands in Greece. The selection of these two geographical areas was based on the different dimensions and potential opportunities for integration as long as the former has received huge refugee flows while the latter has not yet received refugee flows and can be considered as an appropriate field for entrepreneurship-business development and consequently, as an area which could potentially foster refugees' integration in the productive process. Thus, the main objective of this research was to record and categorize the prospects and barriers to refugees' integration into the Greek socio-economic system by examining two diverse but representative rural and insular regions in terms both of integration problems and prospects. The research outcomes are expected to contribute to the construction of intervention directions, which will enhance refugees' social inclusion and development of their human and social capital.

**Keywords:** refugees, immigration, social integration, social inclusion, human capital

**HEALTHCARE POLICIES**

## Identification of The Training Needs of Health Care Professionals In Greece

*Ioanna Tsantili<sup>1</sup>, Stamatina Hadjidema<sup>2</sup>*

<sup>1</sup>Ph.D. Cand. University of Piraeus, Department of Economics, Greece

<sup>2</sup>Professor, University of Piraeus, Department of Economics, Greece

### Abstract

**Aim:** The demand for updating and development on health services has established the need to recognize the potentials of training needs. The aim of the present study is to demonstrate the occupational profiles and identify the training need of the health care professionals who occupied in the public and the private sector in Greece.

**Methodology:** Four hundred fifty three (453) participants had fully completed the valid Greek version of the Training Needs Assessment (TNA) questionnaire. A series of unrelated t-tests and multivariate linear analysis was used to identify the training needs of the health care professionals.

**Results:** All 30 items of the questionnaire were reported by significant training needs and by all health care professionals. The organizational developments considered to be a priority of the health care professionals. Between training needs and sex no significant differences were found. Furthermore for those who worked in the public sector eight items were identified as important. The Cronbach's score was over 0,6.

**Conclusion:** The results indicate that the health care professionals need further training and especially the workers in the public sector in the domain of research/audit.

**Keywords:** health care professionals, training needs analysis instrument, Greece

**This work has been partly supported by the University of Piraeus Research Center**

## **Review of the medical tourism literature: a descriptive analysis of recent trends in Greece**

*Dimitrios Batakis<sup>1</sup>, Konstantinos Zopounidis<sup>2</sup>, Athanassios Vozikis<sup>3</sup>, Symeon Sidiropoulos<sup>4</sup>*

<sup>1</sup> PhD cand., Technical University of Crete

<sup>2</sup> Professor, Technical University of Crete

<sup>3</sup> Associate Professor, University of Piraeus

<sup>4</sup> President of HAPSc, University of Piraeus

### **Abstract**

**Introduction:** It is widely acknowledged that one of the strongest drivers of the Greek economy is the tourism market. Given that tourism alone contributes about 18 per cent to Greece's GDP annually, the diversification of the sector holds a lot of promise.

It is argued that medical tourism aims to mitigate the Greek economic crisis, benefiting from the comparative advantage of the country in providing low cost and high-quality health care services. More specifically, Greece is a popular destination for dialysis patients, as one can find dialysis centres across the country. Nevertheless, Greece has the opportunity to further grow the provision of other medical services such as IVF, eye surgery and plastic surgery. Hence, taking into account the importance of tourism, and specifically medical tourism, it is important to form a strategic plan to improve the medical tourism services in Greece.

According to research conducted from the Hellenic Chamber of Hotels, the long term (around 4 years) optimistic target for patient arrival and expenditure is the arrival of 100,000 patient-tourists spending an average of €4,000 each per year. This scenario involves a patient-tourist spending €3,000 in medical care and €1,000 in accommodation costs – with expenditure totaling €400 million a year. Already, Greek private hospitals have recognized the importance of medical tourism and funded an NGO, 'ELITOUR', whose purpose is to promote medical tourism in Greece, in cooperation with international organizations.

In the past few years, Greece has presented significant growth in the tourism sector - with medical tourism not falling behind in that respect. The main case for Greek medical tourism is the low cost of treatment and high-quality health care services which are provided. The basic component of Greece in comparison with other medical tourism destinations are that health travellers can combine their cure with holidays and well-being services. Greece now finds itself among the top medical tourism destinations in the world. It is no surprise that countless people from all over the world come to Greece to receive medical treatment. Furthermore, Greece is located at the crossroads of Europe and the Middle East, which allows for easy access. This, in combination with the relatively low cost of medical services, has led to an ever-increasing number of non-Greeks seeking hospitalisation in Greece. It is no surprise that there are private hospitals whose patients are mostly non-Greeks and that the rate of repeat patients, in other words the number of non-Greeks who received medical treatment in Greece on multiple occasions, is extremely high.

**Aim of the Paper:** This paper will aim to analyse the current strategic efforts of key policy-makers in the medical tourism sector in Greece. The paper will present the strengths, opportunities and proposals for improvement of the sector's coordination efforts – interviewing major policy-makers and market players. It will also include a comparison of the Greek medical tourism strategy against that of other countries, in order to accumulate the necessary tools to advance the Greek tourist health care units, while also identifying any issues in promoting the product. In summary, this paper will examine how medical tourism can become a major part of the health policy tool-kit in Greece, helping the country become one of the most popular medical tourism destinations worldwide.

**Keywords:** Medical Tourism, Greece, Descriptive analysis

## Health communication: problems and prospects

*Briola Konstantina*<sup>1</sup>

<sup>1</sup>Political Scientist, MSc cand., Athens, Greece

### Abstract

The proper functioning of an organization is one of the most important objectives of management. Communication and collaboration between healthcare professionals are key factors for a proper functioning. Effective communication and good cooperation between the two parties - the physician and the patient - can lead to: disease prevention, improved relationships between medical staff and patients, sharing public and personal information on health risk, changes in health behavior, providing education to the population on how to access the health care system, promoting health and quality of life, etc. However, both in society and in the workplace, apart from cooperation there are also conflicts between its members. Good cooperation between healthcare professionals can be disrupted through conflicts. Conflicts arise not only from disagreements but also through disparities in power distribution, ambiguity in responsibilities, stereotypes, etc. Accordingly, the relationship between healthcare professionals with their patients can be disrupted too. The use of the biomedical model, which is prevalent in a number of countries, raises problems in the quality of communication as it offers a one-sided analysis of a problem. Other reasons that lead to such a large communication gap are the differences in education level, the attitude of the doctors towards their patients, the lack of active listening by the doctor, the lack of time, etc. Both medical staff and patients must overcome the communication barriers, in order to ensure the proper functioning of the system itself. Lifelong learning and professional development can lead to the improvement of communication skills. In addition, this type of continuing education could focus on learning specific protocols/clinical guidelines, which the doctor can follow in order to have a better approach of its patients. Undoubtedly, effective communication between physicians and nurses is needed in order to provide even better services to the patients.

**Keywords:** communication, patients, doctors, conflicts, hospital, healthcare

## Total Quality Management and leadership: a way to improve healthcare services in Greece

*Dimitrios Kritas*<sup>1</sup>, *Symeon Sidiropoulos*<sup>2</sup>, *Dimitrios Kakouris*<sup>3</sup>

<sup>1</sup>PhD candidate at the Department of Political Science of the University of Crete and Field Manager of the Public Policy and Administration Research Laboratory of the University of Crete, Deputy President of HAPSc

<sup>2</sup>President of HAPSc, University of Piraeus.

<sup>3</sup>European Law and Governance School, EPLO.

### Abstract

After the recent economic and fiscal crisis and the increased needs for the provision of better quality health services in Greece, the implementation of appropriate policies by adopting the relevant theoretical approaches has become more critical than ever. The present study examines whether the utilization of total quality management (TQM), in combination with other issues such as the selection of appropriate leadership and patient satisfaction, is reflected in the respective legislative outcomes. In addition, it is investigated whether the specific practices have helped the improvement of health care in Greece and whether there is relevant space and need in a specific direction.

**Keywords:** Total Quality Management, Leadership, Healthcare, Greece, TQM

## **Uninsured healthcare coverage in Greece: KAT General Hospital of Attica case**

***Paraskevi Koufopoulou<sup>1</sup>, Grigoria Betsi<sup>2</sup>, Athanassios Vozikis<sup>3</sup>, Kyriakos Souliotis<sup>4</sup>***

<sup>1</sup> Deputy CEO, KAT General Hospital of Attica, PhD (c), Department of Economics, School of Economics, Business & International Studies, University of Piraeus

<sup>2</sup> Administration Office, KAT General Hospital of Attica, MSc. (c), Health Care Services Management, School of Social Sciences, Hellenic Open University.

<sup>3</sup> Associate Professor, Department of Economics, Director of Laboratory of Health Economics & Management, School of Economics, Business & International Studies, University of Piraeus.

<sup>4</sup> Associate Professor, Department of Social & Educational Policy, School of Social & Political Sciences, University of Peloponnese.

### **Abstract**

Financial crisis has had a direct impact on the provision of health services to vulnerable social groups, such as the uninsured. Our main purpose is to capture the flow and cost of uninsured citizens who came to KAT General Hospital of Attica [Emergency Department (ED), Outpatient Department (OD)] and made use of free health services (hospitalization, medication, operation). We use greek and foreign literature (detected in databases as PubMed, Google Scholar, Elsevier Direct, Cochrane Library, CINAHL) along with primary research, for the years 2015 – 2017. During the period 1<sup>st</sup> January 2017 - 25<sup>th</sup> April 2018 22,087 patients were admitted to hospital, 78.94% (17,436 individuals) in 2017 and the remaining 22.06% in 2018. Specifically, for the year 2017 77.23% (13,467 individuals) were tested on the IEP and 22.77% in OD. In addition, for 2018, both were examined in the ED, as well as at OD, only 4,651 patients out of which 85.33% (3,969 individuals) attended at ED and the remaining 14.67% (682 individuals) in OD. The total cost for the uninsured in these three years 2015 - 2017 amounted to € 12,461,668.14 of which 31.84% (€ 3.6 million) in 2015, 29.23% (€ 3.64 million) in 2016 and the remaining 41.09% (€ 5.1 million). In conclusion, the turnover of patients who made use of free medical care at the KAT General Hospital of Attica has increased steadily in recent years. It substantially reflects the prevailing trend in society for universal health coverage and, above all, the creation of a safety net.

**Keywords:** uninsured, health coverage, Greece, KAT General Hospital of Attica.



## OUT OF POCKET PAYMENTS IN GREECE & CHRONIC DISEASES IN CRISIS ERA: DIABETES MELLITUS CASE

*Paraskevi Koufopoulou<sup>1</sup>, Ioannis Kyriazis<sup>2</sup>, Athanasios Vozikis<sup>4</sup>, Kyriakos Souliotis<sup>5</sup>*

<sup>1</sup> Deputy CEO, KAT General Hospital of Attica, PhD (c), Department of Economics, School of Economics, Business & International Studies, University of Piraeus.

<sup>2</sup> MD, PhD, FNSCOPE, Internal Medicine – Diabetology/Obesity Expert, Internal Medicine Department & Obesity – Diabetes Outpatient Clinic, KAT General Hospital of Attica.

<sup>3</sup> Administration Office, KAT General Hospital of Attica, MSc. (c) Health Care Services Management, School of Social Sciences, Hellenic Open University.

<sup>4</sup> Associate Professor, Department of Economics, Director of Laboratory of Health Economics & Management, School of Economics, Business & International Studies, University of Piraeus.

### Abstract

Diabetes is the fourth leading death cause worldwide, with adult diabetic patients reaching 366 million in 2030. There are 60 million diabetic patients in the European Union and 1 million in Greece as a consequence of overweight, obesity, unhealthy nutrition etc. Instant result is the financing of health systems, from patients (out of pocket payments). The evolution of private health expenditure in Greece, through diabetes mellitus. We use Greek and foreign literature through the electronic databases PubMed, Google Scholar, Cochrane Library, Elsevier, CINAHL and Science Direct for the period 2010 - 2016, regarding private health expenditure through diabetes. Diabetes mellitus cost, ranges from 3% to 6% of total health expenditure (average annual per capita expenditure is 2.834 €). In Greece, with a 35.4% private health cost share, the average cost per patient is estimated at € 1,300 per year (31.1% annual medication, 44.8% required exams and 24.1% wage staff). Furthermore, the average annual cost would be over 3,000 € per year and triple the total financial burden of the disease. Chronic diseases, such as diabetes mellitus, react on morbidity and health costs. Prevention is the only solution, through early diagnosis primarily from the health system and secondarily from the patients. Reconstruction of services through the contribution of Primary Health Care are the main point.

**Keywords:** diabetes mellitus, out of pocket payments, Greece.

**ISSUES OF ENERGY AND SUSTAINABLE DEVELOPMENT**

## Carbon Pricing: recent developments in European Union

*Christos Bentsos*<sup>1</sup>

<sup>1</sup>MSc Energy and Finance, International Hellenic University

### Abstract

This paper summarizes the contemporary issues on carbon pricing in European Union concentrating mainly on the EU – Emission Permits Scheme (EU-ETS). Firstly, the forces and the main treatments concerning the combat of climate change which led to the establishment of the EU – ETS are referred. Then, the carbon pricing initiatives are discussed as well as the effective carbon rates and their components. The next topics have to do with the challenges of carbon pricing initiatives, their financial aspect, and the carbon pricing corridors. Then the paper is focused on the EU-ETS. The way that system works theoretically, and the implementation phases are examined. More specific, the permits' allocation to countries through the phases, benchmarks, auctions' conduction and revenues' use are analyzed. Issues which are investigated concern the union registry, the monitoring, reporting and verification and the compliance cycle. The following topic associated with the carbon price concentrating on determinant factors and price evolution during Phase I and II. Then EU ETS effects on firms' competitiveness and EU-ETS after Brexit and 2020 are also discussed. Lastly, the recent developments in shipping industry are discussed.

**Keywords:** EU ETS, carbon price, European climate policy, carbon tax, shipping

## A Game Theoretic Analysis of Energy Security in the Eastern Mediterranean

*Vasileios D. Papakostas*<sup>1</sup>, *Elissavet E. Bekou*<sup>2</sup> and *John A. Paravantis*<sup>3</sup>

<sup>1</sup>Graduate Student, University of Piraeus, Greece

<sup>2</sup> Graduate Student, University of Piraeus, Greece

<sup>3</sup>Associate Professor, University of Piraeus, Greece

### Abstract

Energy has been elevated to a major concern in the eastern Mediterranean. Recent oil and gas discoveries in the area could affect Europe's energy dependency from Russia and provide an alternative for energy imports. However, opposing interests of neighbouring states could cause turbulence which would seriously affect this prospect. This research examines the impact of Greece, Cyprus and Turkey foreign policy interactions on the energy security of the eastern Mediterranean. Two game theoretic models were formulated to develop predictions about the future interactions: a sequential move game for the Turkey-Cyprus case, and a simultaneous move game for the Turkey-Greece case. The equilibria of these games were studied, taking into account the results of sensitivity analysis. Then, results showed that Turkey is likely to continue to not recognize (and violate) the Exclusive Economic Zone (EEZ) of Cyprus, while Cyprus will continue its activity in the disputed area. Turkey will also continue to dispute the Greek EEZ and its right to an expansion to 12 nautical miles. Turkey will likely try to seal delimitation agreements with Libya, bypassing Greek claims. In case Turkey fails to find an agreement with any of the littoral countries then its naval routes to Mediterranean will be blocked and it will be excluded by the hydrocarbon game in the area. This will affect the energy security of the region since Turkey is not expected to accept idly such a contingency. Nevertheless, armed conflict is likely to be avoided. The paper provides suggestions and urges for further study.

**Keywords:** Greece, Cyprus, Turkey, Aegean Sea, Eastern Mediterranean

## **Energy (oil & gas) as a power factor in International Politics: The “Encompassing Realism” as an exploratory and explanatory framework**

*Vasileios Balafas<sup>1</sup>*

<sup>1</sup> PhD candidate, Department of Political Science and International Relations, University of the Peloponnese, Assistant Research Fellow, Centre of International & European Political Economy & Governance – CIEPEG UoP, Department of Political Science and International Relations, University of the Peloponnese.

### **Abstract**

The mid-2010s brought about a considerable realignment to the global energy landscape. The shale revolution has enabled the US to pursue a net-exporter status, resulting in a continuous oil exports growth into Europe and Asia. US President Donald Trump have gone even further to call for energy supremacy. In June 2017 he staked a claim to “American Energy Dominance”.

President Vladimir Putin’s “energy superpower” vision has sealed Russia’s behavior in the international affairs since the mid-2000s. It has been the main driver behind Russia’s ambition to return to the “old glory” and regain a role as a great power. Changes in US energy policy has forced Russia to cooperate with OPEC in order to react both to the meteoric fall of oil prices in 2015-2016 and to market share losses.

Emerging countries are also trying to strengthen their role in the energy landscape. China has started seeking for an upgraded role in the international arena via a grid of bilateral and regional energy strategies including, among other strategic moves, its Belt and Road Initiative (BRI). Brazil and India have also been pushed to engage in the energy play. The former is currently turning into a major oil exporter thanks to important new oil field discoveries. The latter has become one of the world’s biggest energy investors since 2017.

Many other countries such as Egypt, Turkey, Greece, Cyprus seek to upgrade their role in energy production and distribution via natural resources’ exploration and exploitation, transnational agreements for relevant infrastructure, combining this target with terms of national interest and amelioration of their local, regional and international position.

The proposed “Encompassing Realism” and its components aspire to offer an exploratory and explanatory framework. It examines forms of power exercise and demonstration, and changes in state energy power status. It also shows that energy is a component of state power that can be used even in the absence of the energy resources attribute, drive systemic rearrangements and modify intra-state preferences.

**Keywords:** Energy, power, state, IR theories, Realism

## The governance of local responses to global food sustainability challenges

*Sevasti Chatzopoulou<sup>1</sup>*

<sup>1</sup>Department of Social Sciences and Business, Roskilde University

### Abstract

Industrialised farming practices cause widespread degradation of natural capital and negative environmental externalities across the food value chain. Significant amount of food produced and transported gets lost or wasted. Additionally, the nutritional value of food has decreased over time as many foods contain traces of toxic chemicals and plastics. Consequently, the current production systems are not sustainable and transformation of today's food system is necessary.

Systemic transformations incorporate various challenges, new opportunities and additional risks. They require resources but also knowledge on building synergies that connect the different actors and levels in the governance process. Applying a governance perspective permits to investigate in a non-rigid hierarchical manner public and private actors and institutions at various levels in the food value chain. The governance perspective also considers formal and informal aspects of interconnections, and their effect on sustainable innovations that incorporate social, economic and environmental dimensions.

This paper identifies a number of factors that contribute to sustainable changes in the governance of sustainable food production systems: a. shorter food supply chains, b. use of biotechnology c. emphasis on local food traditions and circularity; d. gender equality and e. gastronomy innovation. First, shorter supply chains can provide freshly produced food that does not need to be transported in long distances and use energy. Second, biotechnology can be used to develop crop varieties locally that cope better with drought and salinity, are more disease resistant and use nutrients more efficiently, considering geographical characteristics. Third, emphasis on local food tradition can strengthen healthier living, a diverse food culture, and socially inclusive practices that strengthen cohesion in local communities and ensure circularity and efficient use of resources in food systems. Fourth, the food has become overtime a traditionally male dominated sector despite the fact that food is directly connected to the everyday family life. Reconsidering the role of gender equality in food systems can provides new dimensions for a more balanced understanding for sustainable food systems. Finally, food diversity encourages new ways of thinking and gastronomy innovation. The paper analyses these factors based on documents and a series of interviews with public and private actors.

**Keywords:** Local governance, sustainability, food

**MEDIA AND THE DIGITAL ERA**

## The TV commercials of the Greek bailout referendum 2015

*Aggeliki Flora Thanopoulou<sup>1</sup>*

<sup>1</sup>Undergraduate Student, Communication and Mass Media, National and Kapodistrian University of Athens, Greece

### Abstract

In this study examined are various political advertisements, concerning the Greek bailout referendum 2015, which was proclaimed by the Greek Prime Minister Alexis Tsipras, on 28th June 2015 and took place on Sunday 5th of July 2015. The Greek people were asked to vote whether the agreement plan submitted by the European Commission, the European Central Bank and the International Monetary Fund to the Eurogroup of 25th June 2015, should be accepted or not by the Greek government. The opinion of the government about the dilemma of the referendum, was the agreement to be rejected. The options of the plebiscite were, NO, YES or the opinion of the party KKE, which urged the voters to say no to the proposal of the tree European institutions and also to say no to the proposal of the government.

Primary target of this study is to investigate whether, during the short period of one week before the referendum, the Panhellenic broadcasting private TV channels, ANT1, STAR, ALPHA, SKAI and MEGA promoted one of the three political thesis, NO, YES or the opinion of the party KKE, and if one was promoted more than the others by how much on a quantitative basis. On the theoretical part of this study, the meaning and the purpose of the advertisement is to be examined, as well as the evolution of Greek TV and the conditions under which the plebiscite took place. The method used in this study was the content analysis for studying 399 political TV commercials during the period 28th of June until 5th of July 2015. Basic research result is that all private TV channels took the same position favoring YES against NO and the opinion of the party KKE. Despite the fact that YES was vastly promoted, NO finally was the prevalent opinion.

**Keywords:** referendum, political advertisement, television

**EU INTEGRATION, POLITICS AND GOVERNANCE ISSUES**



## Regional Integration in the EU; The Community Method and the Open Method of Coordination

*Ilektra Simitsi*<sup>1</sup>

<sup>1</sup>PhD Candidate, University of Democritus, Greece, + MSc in European Law, University of Democritus, MSc in Public Policy and Human Development, Maastricht University, ilektrasimitsi@gmail.com

### Abstract

Regional integration is a method that regional organizations seek to achieve and deepen. Though, integration is not an easy process and is gradually fulfilled. Initially the “regional organization” is defined, as an organization structure, in a geographical setting, functioning under specific rules, through the directions of regional institutions, and the important and necessary participation of members and stakeholders. The regional organization highlights the establishment of a common ground for all those involved contributors. But how is integration and convergence achieved?

It is true that standing alone in a globalized world hinders the achievement of state objectives. Collectivity and cooperation on equal and horizontal terms facilitates policy making. One of the most studied and described successful examples of peripheral or regional organizations is the European Union. In the EU, different states have agreed to entrust part of their state sovereignty to a supranational organization by establishing agreements in multiple economic fields in order to support their strategic targeting and direction. This is the reason why it has been selected to define and describe regional integration through the application of hard and soft law methods.

In this current paper we will take the example of the EU to examine the results on integration by comparing the Community Method with the Open Method of Coordination. A Hard Law process compared to a Soft Law policy making process. The paper deals with the benefits and hurdles of output legitimacy vs process legitimacy and their effectiveness on regional integration. These Methods have been selected since there is a dispute over whether they ultimately affect or serve the interests of their members by actually promoting European integration, participation and cooperation or if they ultimately hinder the integration process.

**Keywords:** Regional Integration, Soft Law, Hard Law

## Cultural distances in times of crises How Greeks and Hungarians see themselves and others

Nikos Fokas<sup>1</sup>, Gábor Jelenfi<sup>2</sup>, Róbert Tardos<sup>3</sup>

<sup>1</sup> Professor of Sociology, Department of Sociology, Faculty of Social Sciences, Eötvös Lóránd University

<sup>2</sup> PhD Student, Faculty of Social Sciences, Eötvös Lóránd University, Higher Education Institutional Excellence Programme of the Ministry of Human Capacities in Hungary fellowship grant number 1783-3/2018/FEKUTSTRAT

<sup>3</sup> Sociologist researcher, Eötvös Lóránd University, grant number 1783-3/2018/FEKUTSTRAT

### Abstract

2015 was an extraordinary year for Europe, and particularly for Greece. Greece went through a very critical period of her debt crisis. During 2015 a number of events happened in Greece, which has consistently maintained the intense interest of the national and international media. Furthermore European public opinion was shocked by the unprecedented scale of the refugee crisis. By the end of August 2015 the huge refugee flow entered in Greece to EU has already arrived in Central Europe and especially in Hungary. It is clear that both Hungary and Greece were significantly affected by this refugee crisis.

The lecture deals with images of these “crises” in public opinion of Greece and Hungary based on a parallel online survey of MTA-ELTE Peripato Research Group in Budapest and National Centre for Social Research (EKKE) in Athens at the beginning of 2017.

Our starting point was the seminal work of Buchanan and Cantril titled *How Nations See Each Other*, which was first published in 1953. A few selected examples of the results emerging from our survey concerning national stereotypes related to Americans, Arabs, Germans, Greek, Hungarians and Russians will be presented.

In addition to the survey, the analysis of a wide database of online dailies enables us to outline a semantic web of mutual images in the contents of daily papers - of various political platforms - from both Greece and Hungary.

A composite index was calculated based on the aggregation variables contained indicators related to personal situations, satisfaction with economic situation and perception of most important problems. We adopted labels used by the Cantril ladder, „suffering” and „thriving” segments on the poles of crisis perception. The changes between the „thriving” and „suffering” segments in the Hungarian sample are less than in the Greek sample. The Greek total sample is more defined by the „suffering” segment, less difference is observed in the Hungarian case.

**Keywords:** comparative study, media image, semantic web, cognitive maps, network analysis, 2-mode network, immigration attitudes, refugee crisis

## European Policy for Economic and Social Cohesion Greek Community Support Frameworks – Comparative Historical Review

*Panayiota Seva-Agolli*<sup>1</sup>

<sup>1</sup>Political Scientist, European Project Manager

### Abstract

**Introduction:** The economic and social cohesion is a fundamental prerequisite for the progress of the European integration. The Common Market, the functioning of the EMU and the single monetary policy require the adoption of redistributive politics to reduce regional disparities within the European Union. In order to facilitate the real convergence of economic structures and levels of development, the EU's Structural Policies (SPs) are of the most serious issues that need to be addressed. Greece's convergence with the EU average level of prosperity depends on the amount, the duration and the type of assistance provided by the EU Community. The increase of EU funds has been the steadfast political and financial target which, through the development programmes, generates inputs that reach 4-5 % of the Greek GDP.

**Aim:** The purpose of this study is to compare the Community Support Frameworks (1<sup>st</sup>, 2<sup>nd</sup>, 3<sup>rd</sup> CSFs) in Greece, as well as to compare the results of corresponding applications in Ireland, Spain and Portugal.

**Background and Methodology:** The present study focuses primarily on: the historical background and the need for the existence of EU Structural Policies, the structure, their bodies, and the principles governing their functioning. Emphasis is given to: the Greek CSFs and their programming process, the implementation, monitoring and evaluation, their critical evaluation, the macroeconomic-political impacts, the analysis of causes of ineffectiveness and the comparison of SPs' results in Greece with other indicative EU Member States.

**Conclusion:** The economic and social cohesion requires the design and implementation of broad, integrated and coherent Community actions and politics. The strategy of substantial convergence goes beyond the decisive intervention of the EU Budget which, in order to support the full implementation of EMU, will need to be strengthened and reach 5-7% of the Union's GDP.

**Keywords:** Greek Community Support Frameworks, European cohesion

## **The Greek Social Integration Structure in the Framework of European Aid, an Evidence From the Field**

*Panayiota Seva-Agoli<sup>1</sup>*

<sup>1</sup>Political Scientist, Researcher, European Project Manager, Greece

### **Abstract**

Four years on from the tragedy of Lampedusa which raised a distress voice and signaled the so called European Migration-Refugee Crisis. Even if the migrant-refugee flow is not a new phenomenon in Greece, during last years the country experienced a situation of unprecedented proportions with social consequences and financial limitations. However, thousands of migrants and refugees, after living in inhuman conditions, after passing through slow procedures of asylum services, are now called to address another challenge, their integration into the host society. This study aims to investigate migrants/refugees' adaptation in Greece and how the integration structure is assisted and strengthened by the framework of European aid policy. The current quantitative and qualitative research focused on conducted interviews by 200 persons from different countries who arrived in Greece during the last years. The gender and age groups were considered, unaccompanied minors over 16th were included as well. Through a questionnaire with particular focus on: their lives in the host society, the support of family functioning, the inclusion into the health and educational system, the labor market and the broad social context, research outcomes indicated the lack of coordinated integration mechanisms in the beginning of the rising crisis, while NGOs and social associations took action to fill the gap. The increased European financial/expertise support contribute to capacity building and improvement of adaptation structure which consists of free legal and social services offered by NGOs and public authorities, equal access to health care, children's access to education and various cultural activities. Although the housing projects have been implemented to manage the inhumane and inappropriate living conditions, the accommodation issues still remain. Delays in the asylum application proceedings and language barriers are conducive to isolation from professional training and limited employment opportunities, affecting the integration process and adaptation to the new society. Research findings suggest a need of asylum process acceleration, coordinated language courses for adults offered by public institutions close to areas of residence, targeted professional training and employment assistance, NGOs and public service providers should collaborate to enable their interactivity with persons of concern in order to efficiently proceed the integration efforts.

**Keywords:** (refugees integration, european refugee crisis)

## Has the European Union democratic deficit?

*Nick Kosmadakis<sup>1</sup>*

<sup>1</sup>PhD cand., University of Crete

### Abstract

European Union is a European supranational organization, which operates on the basis of the freedom. The European peoples feel equal each other. The European Union was created as a construction which will ensure the well-being of European peoples, but set as priorities the values of freedom, the equal coexistence of different ethnic groups, the solidarity and the defense of human rights. There are not few people who believe that the EU is nothing more than an idea which was born in the Treaty of Lisbon. They can't accept that a EU has and another perspective, which includes: offices, boards and administration.

However, the economic crisis of 2007 where the European organisation appeared too unprepared to deal with this crisis and the migratory-refugee crisis of 2015 were two major trials. Many claim that these two trials have downgraded the European venture, as its moral values have been questioned. The result was that the EU would appear as a transnational organization with a democratic deficit that does not show proper respect of its people.

The economic crisis was presented as a complex and dangerous event which will last for decades. The non-common economic policy of the Member States and the economic inequalities quickly created the impression that the United Europe is actually a two-speed Europe. And in particular, there is a economically developed North and an underdeveloped South.

And the migratory-refugee crisis of 2015 had an adverse impact on the EU. When the peoples of Europe were called upon to cope with this problem, a big portion of European states expressed their dissatisfaction, refusing to accept refugees within their territory. There is no more typical example than that of the Prime Minister of Hungary, Orbán. These kinds of behavior combined with the rise of far-right parties across the continent, mark a new page where xenophobia dominates and the emergence of culture as human software is being questioned.

This suggestion is an attempt which will be made to answer the question whether the EU has democratic deficit through economic and refugee crisis and how the European Union will become more democratic.

**Keywords:** European Union, democratic deficit, democracy

## **The Major Reason Why the EU & IMF Bailed Out Greece Was?**

*Theoharris Efthymiou – Egleton<sup>1</sup>*

<sup>1</sup>Student Stowe School, HAPSc under 18, Stowe, Buckingham MK18 5EH, UK

### **Abstract**

For most of the 21st century, Greece has been in a troubling financial position. Largely, this was the result of massive borrowing, initially supposed to be used to improve infrastructure but, over time, was spent on a plethora of revenue items such as more state employees, increased state pensions, and over-generous government contracts.

The spending, many believe, arose from Greece's premature entry into the European Union in 1981, a topic briefly explored in this text. Most observers believe that entry was only secured because of Greece's almost perfect geopolitical position and to protect democracy in Southern Europe at the height of the Cold War. The entry into the EU was quite a coup for the West considering the brutal civil war fought between 1946 and 1949 - considered by many to be the first proxy war in the then-nascent Cold War.

The controversial 2001 entry into the Eurozone was dogged by notions that the application figures were false and that this was almost certainly known in parts of the EU's inner circle. This begs the question; did Greece have a strong position at the EU table and, if so, why? A realistic answer to this question can only be found deep in the complicated world of Geopolitics. Exploring this could play a massive role in helping to resolve Greece's current position, and in turn affect the lives of many others in the EU.

This paper aims to provide some indicative answers on the above as well as on Greece's current position where one of its main aims is to reduce its debt mountain using, if possible, its geopolitical position as leverage over the EU and the West. For example, Greece's largely Western cultural influences could be a major asset during a tense time in world politics when relationships between countries are plagued with lack of trust. For these reasons, a brief history of modern Greece has presented alongside some basic economic points as well as aspects of the bailouts themselves, while trying to explain some of the major geopolitical influences involved.

**Keywords:** geopolitics, Greece, EU, IMF, culture

## Towards a United Europe: The case of the German Unification

*Dimitris Michalis Tritsetakis<sup>1</sup>*

<sup>1</sup>Student, Department of Sociology, Panteion University, Athens, Greece

### Abstract

The following study discusses the historical and sociological analysis of the formation of the European Union, while attempting a comparative approach to the unification of the German states and the formation of the Second Reich. In this paper, we want to demonstrate the importance of a political leader as a driving force behind history and the expression of popular sovereignty, but also to point out the cohesive links able to hold a large state united. We will first examine the history of the European Union, beginning from the aftermath of the Second World War in the Old Continent. We will also examine the social, economic and political conditions that allowed the conclusion of the first European Community Treaties and briefly examine some key elements of these agreements. Then we will analyze in detail the decision-making process of the main bodies and institutions of the European Union and extensively examine the role and composition of the European Parliament. We will also look into the economic, political and social conditions developing between the many states of the European Union and their cohesive links. We will then compare the above cases and results with the specific ways and reasons the First German Empire was constructed under Bismarck's watchful eye. We will take a brief look at the aftermath of the Napoleonic Wars in Europe, the Congress of Vienna and the events following the fall of Chancellor Metternich. We will also discuss about the liberal revolutions in the Rhineland region and Prussia and the formation of the first legislative bodies on German territories. We will subsequently examine the failed attempts to unify the German states and the events that lead to the Prussian dominance over all of them and also the creation of the North German Confederation and the Austro-Prussian War. We will eventually analyze the outcome of the Franco-Prussian War and the unification of the German states into the First German Empire. In any case, the prevalence of radical methods is apparent in the case of the German Unification, which is the main difference between the two cases.

**Keywords:** European Unification, Bismarck, European Union, Germany, Europe, History, Society.

## Europe's 'Green Light': An Agambenian Approach to the Oath of Independence

Savvas Theoulakis<sup>1</sup>

<sup>1</sup>Department of International & European Studies, University of Piraeus, Greece

### Abstract

The paper begins with an examination of the Oath of Independence through the lens of the agambenian conceptualization, through which the position of the Commission within the European Union's political model is to be attested. Subsequently, special focus is given to the Commission's Power of initiative (17(2) TEU) seen as a manifestation of *Potentiality* and, through Agamben's use of *messianic temporality*, the Commission is conceptualized in terms of *Sovereignty* and as a 'policy entrepreneur'.

In the second section, a close reading attempt takes place in order to interpret the "General Interest of the Union", as found on the second clause of the Oath, in agambenian terms. In order for the notion to be interpreted, the concept of the Self of Europe is investigated. After a brief taxonomy of the main narratives concerning self-other relations in the international relations and European integration literature -namely, *self-transcendence* and *ontopology* in temporal and spatial othering respectively -, we return to the agambenian system that aims to shed light on the *Bankruptcy* of the political subjects that assign and take on *historical tasks*. Through the politics and ethics of *Inoperativity*, societies of '*beings radically devoid of any representable identity*' in an era '*no longer wanting to be an historical epoch*', bring forth a conception of the Self whose own bankruptcy -which, according to Sergei Prozorov, can neither be concealed nor relegated but fully assumed, maintained and raised to ethos- constitutes its Other residing within it. Following Prozorov's analysis of Europe's self-other relations in the context of agambenian political philosophy, and through his conclusion that, as far as the Self of a continent where '*all the peoples (...) have gone bankrupt*' is concerned, the figure of the Other is to be found in its present whose bankruptcy Europe must, according to him, testify to in order to attain its subjectivity. In that context, the aforementioned "General Interest of the Union" arises as a manifestation of the *Stasis*, while the Commission's Power of the Initiative reappears in the form of the heideggerian *Freedom*.

**Keywords:** European Commission, Oath of Independence, Giorgio Agamben, History, Philosophy



## Democracy in danger: the challenge of reshaping Europe's democracies into a more direct-democratic model

*Nikolaos Koutsoupas<sup>1</sup>, Ioannis Mpoitsis<sup>2</sup>*

<sup>1</sup> Associate Professor, University of Macedonia

<sup>2</sup> PhD Candidate, University of Macedonia

### Abstract

Europe's democracies are facing a noticeably big challenge. The rise of far-right parties, UK's Brexit, the demographic problem, as Europe tend to become an "aged" continent, the economic crisis and the growing rates of dissatisfied, with the political situation, citizens of Europe, compose the image of today's European democracies. More and more European citizens are choosing either abstaining from the elections or the so-called protest vote which has given the opportunity to many far-right - anti-systemic parties to have the role of regulator or even worse to have formed government coalitions in the political scene of their country. Beyond these problems, however, we believe that the worst thing about the function and about the true essence of democracy is the sense on the part of citizens that corruption is now a key component of politics and that engaging in politics makes absolutely no sense. The concept of the technocrat and the admittedly complex challenges of the modern political scene have turn citizens, from a driving force and key factor in the political scene, into mere spectators. This is exactly the point that threatens the true essence of democracy.

In this presentation, we address the above concerns as the basis on which we compose our proposal for a new discussion on the terms and conditions of the function of democracy. According to Antisthenes the cynic, to examine what each name-word really means is the beginning of the wisdom, and on the basis of this statement we examine what democracy really means and how the active participation of the citizens is exactly what democracy means. Our view about a more direct democracy starts with the activation of citizens initially through municipalities, following the proposal of Benjamin Barber who, in our opinion, understands very well understands the need to limit the distance of the citizen from the rulers. Using the abilities of the internet, many processes can be simplified, and citizens can be given the opportunity to participate more and more actively through a "political" networking platform. We believe that the debate on the reform of democracy, in addition to its theoretical value, has a practical essence. The democracies of Europe are at a turning point, and if we want to save them, we must give citizen its true meaning and include him in the central political scene.

**Keywords:** European Union, democracy, direct-democracy model

## **Building the United States of Europe: Towards European Integration**

*Georgios L. Vousinas<sup>1</sup>*

<sup>1</sup>Doctoral Researcher, National Technical University Athens, School of Mechanical Engineering, Section of Industrial Management & Operations Research, Greece

### **Abstract**

Europe has reached a crucial crossroad in light of the recent global financial recession that originated in 2008 following the fall of Lehman Brothers in the United States of America. The crisis stroke mainly the economies of Southern Europe, the so called P.I.G.S. aka Portugal, Italy, Greece and Spain, but even today threatens the whole European Union (EU) structure, despite the rescue programs and the targeted measures engaged. Even more, the ongoing migrant crisis (along with the financial) has changed the political landscape across Europe, with the rise of the nationalist and Eurosceptic parties. So these days the debate around the idea of creating the “United States of Europe (USE)” is more up-to-date than ever. The aim of this paper is to shed light on issues such as whether this project is in favor of the European citizens, whether it will strengthen their unity or the opposite and if this new entity will increase Europe’s influence in the world scene. It is emphasized that the participation of the EU in the rescue of countries like Greece showed that when cooperation is maintained and common rules act, the final result is for the best, with better terms and conditions. Finally, certain policies are suggested and the challenges ahead are analyzed, hopefully initiating a fruitful academic discussion on this critical subject among the various stakeholders.

**Keywords:** Europe, Integration, Union, United States of Europe.

## **The “phenomenon of osmosis” in the EU: National Parties and European Political Groups**

*Sofia Magopoulou<sup>1</sup>*

<sup>1</sup>BSc Student, Aristotle University of Thessaloniki

### **Abstract**

In the terminology of Chemistry, osmosis is described as the process where solvent molecules move through a semipermeable membrane from a dilute solution into a more concentrated solution. In the reality of the European Parliament Elections, as “osmosis” we can describe the interaction of the European level with the national, with the actors playing the role of solute-solvent as appropriate.

This paper examines the relation between national parties and European Political Groups in the basis of their placement in topics that concern European policies and institutions. It investigates how European Political Groups place themselves in comparison to national parties in matters concerning migration, economy, environment, foreign affairs and institutions.

Principally, we aim to analyze the axes of competition on a national and European level based on the traditional cleavage of “right-left” and “isolationism-cooperation”. We aim to create compact clusters of parties using the method of hierarchical clustering.

**Keywords:** Electoral Analysis, European Politics, European Political Groups, European Policy, Axes of Competition

## Strategic Management for Political Parties

*Despina N. Kanta<sup>1</sup>*

<sup>1</sup>Department of Business Administration, MBA TQM International, University of Piraeus

### Abstract

The central idea of the present statement is the analysis of the way via which the private companies' expertise could be of benefit to the political parties for issues concerning management, policy planning and setting of values and targets. Through already existing approaches such as the Total Quality Management, the Management via objectives and the Management by example, it is attempted to examine the common ground between politics and role model – companies, the potential adoption of good standards developed by the role model - companies from the political parties, as well as the examination of the other sectors that relate to the parties' internal management and organisation.

Following the political developments comparing with the course followed by the role model – companies during the financial crisis period and recognising the total approach of the strategic management in management, administration and education issues, the acknowledgment of the “common points” and the translation of the knowledge revealed by the friction with the strategic management objective in terms and conditions of political parties, remained. The difficulty met trying to correlate these two fields is that no bibliography exists about political parties' strategic management, only bibliography about business management or operational ways and types of political parties. Strategic management is the business administration sector that relates to the programming, organisation, administration, control and coordination of all the individual procedures that link together for the accomplishment of a target.

The aim is to approach the issues relating to management matters with special reference to those concerning the human resources management, the culture, the management standards under the private companies' standards, the political parties' leadership and other techniques developed by the role-model companies. In light of what the political parties need is the redefinition of their moral values, better management, the adoption of new updated practices and the consolidation of outdated methods that have been proven insufficient for the covering of the Greek society's needs, it is clear that this can only be achieved by adopting strategic management principles.

**Keywords:** Strategic management, political parties

## **Citizenship in a hypothetical European Federal State. Can the European society and the public administration handle and solve this situation as a Federal State?**

*Aristeidis Velonis<sup>1</sup>*

<sup>1</sup>University of Macedonia

### **Abstract**

Due to the fact that Europe has many common characteristics with a federal state, in this paper it would be discussed how the European society and the public administration could handle this situation as an hypothetical federal state. It is also true that citizenship in the EU has been a topic of many discussions and remains a complex issue. In this paper, we will find out how citizenship could be solved in a federal state and from what is consisted the proper European citizen. The reason why this subject was chosen is because that Europe as a federal state seems to be a very interesting issue and can be compared with other federal states, such as the USA, which have many common characteristics. The structure and the theoretical approach in this paper have at first an introduction at the first part, which explains in detail the reason why this subject is being chosen, the hypothesis of the federal state view generally and the main reason of what this paper want to approve. In the second part, the main body of this paper will be explained. The issue of citizenship should be approached from different chapters. For example, the history and the culture of the EU members have also important role. But the positive is that in this hypothetical federal state, there will be a common political situation that maybe can solve the issue of citizenship. We do not have to compare the different political situations. To sum up, the third part is the conclusion. Due to the theoretical analysis in the main body, we will be able to discuss that maybe the federalization of the EU should be effective in order to solve the issue of citizenship.

**Keywords:** Citizenship, Federalization, European citizen, European history, European culture

## What is the approach of European and Greek courts when they address interferences with socioeconomic rights resulting from the European Union's financial assistance programmes?

*Ellie Tsougrani<sup>1</sup>*

<sup>1</sup>LL.M ('17), LL.B. ('15) (University of York) – GREECE

### **Abstract**

This paper attempts to piece together important aspects regarding the violation of socioeconomic rights in the era of European Union (EU) financial assistance. These issues include the lack of accountability of EU and international financial institutions, such as the European Stability Mechanism (ESM) as these are observed within European case-law. The dissertation focuses on the examination of a case-study based on the Greek state's interferences with social security entitlements, which demonstrates the value and limitations of the judiciary in the protection of these rights in the era of austerity. Through an analysis of legal, political and social factors it is shown that this important problem is often judicially justified as a legitimate public interest interference and for this reason, there are limitations in pursuing judicial enforcement of social security. In outlining the limitations of European and Greek courts, the socio-political and economic implications are also considered. The analysis concludes that effective protection of social security in Greece, could only be achieved via an integrated approach which would include efforts by the executive, the legislature, the judiciary, civil society as well as changes in institutional accountability on the supranational level. The developments within the EU's political order that are currently occurring, are also bound to influence the judiciary, but the way this will be reflected within Member-States under EU financial assistance remains to be seen.

**Keywords:** European Union; financial assistance; socioeconomic rights; Greek crisis

**INTERNATIONAL RELATIONS, DIPLOMACY AND  
GEOPOLITICS**

## The European Union and the Arctic: Managing the Future Developments

*Nikolaos Nikolaou<sup>1</sup>*

<sup>1</sup>MA "International and European Studies", Greece

### Abstract

Arctic: its name leads the mind to places far away and inaccessible, full of ice, somewhere in the Northern Hemisphere. But the Arctic is not a distant territory. It is something closely-related and vital to the natural environment and the survival of mankind. Because its importance is great and the need to protect it imperative, institutions have been set up to deal with issues that concern it, while international law creates a framework of obligations that protects it together with the rest of the planet.

At the same time, with the new opportunities created, it is expected to become a ground of a new geopolitical competition. There is already a small scale competition between coastal states and other non-neighboring countries which aim at exploiting the resources it provides. This competition is most likely to have dramatic effects on security, the environment and the economy.

The European Union is also a part of this increasingly worrying context. The Arctic concerns it. Some of its member -states are "Arctic", while competition and its consequences need to be taken into account because they affect politics, the economies and societies. The Arctic, in other words, is in the European neighborhood. Therefore, dynamic actions are required. The European Union has already taken action, but other actions with a longer-term targeting are necessary. What the Union has to do to "safeguard" itself in the new reality being formed is a question that is reasonably born, but it can be answered. Europe should take the Arctic into account and design policies to protect it.

This paper examines the value of the Arctic and the institutions and legislation adopted to regulate issues that consider it. Also, reference is made to the strategies of the various states that target it. Next, there will be a presentation of the European Union's "Arctic" policy so far, whereas policy proposals will be presented so as to the European Union manage to cope with the new tough confrontation for dominance in the Northern Hemisphere.

**Keywords:** European Union, Common Foreign and Security Policy, Arctic

## **USA, Europe, China: A fluid global political-economic landscape with uncertain future?**

*George Athanasopoulos<sup>1</sup>*

<sup>1</sup>BSc Student, Panteion University of Athens

### **Abstract**

The present study concerns the relations that have developed between Europe and China, as well as the relations between Europe and America. Undoubtedly, in a constantly changing global environment, not only changes in the relational context of states or continents are observed but also structural changes within states and their values. The increasing intensity and proliferation of globalization has contributed significantly to the evolution of the global system.

By definition globalization advocates world trade, the multilateral cooperation of states in the majority of the main areas of social, political and economic activity. However, its enlargement has caused many inequalities and reduced existing ones. At the same time it raised the question of the question of democracy and many other fundamental world values.

In the way the global system was shaped, as it is today, the US has played a key role as the leading force throughout the planet. Through successive American policies, the evolution of the whole world depends on it.

The current Trump administration has significantly stigmatized global events through its actions. His moderate and far-sighted attitude towards Europe, coupled with his aggressive policy against China, is a key indication of the changing direction of the world order.

At this point the study comes to highlight Europe's role and how important its relations with both America and China play. So first, once its role in the global system is identified, it will be seen whether its action converges with global priorities. The following is a reference to Trump's policy on how it affects America's position vis-à-vis the other Powers, as well as America's relations with the European Union.

Consequently, Europe has not only entered into partnership relations with the American superpower but also with one key partner, China. Euro-Chinese cooperation counts for many years of survival and it is of great interest to see whether both sides are involved in its preservation. The analysis of Euro-Chinese relations will also give an indication of Trump's influence. Finally, the study - work will be completed by drawing safe conclusions about the current situation and an assessment of the future of these relationships.

**Keywords:** Europe, U.S.A, America, relations, China, changes



## A Theoretical Approach to the Cyprus Problem: Securitization, Neoliberalism, and Neoclassical Realism

*Nikos Lekakis*<sup>1</sup>

<sup>1</sup>PhD, University of Crete, Department of Political Science, Greece

### **Abstract**

This paper places the Cyprus Problem in an international relations (IR) framework and covers the period following the invasion of Cyprus in 1974 by the Turkish army to-date, searching for a “foreign policy outcome” - essentially a decision by the leaders of the two communities to approve relevant UN initiatives towards a solution. The paper provides a synthesis of securitization theory, and the neo-liberal and the neoclassical realist paradigms, aiming to better interpret the existing experience and shed light on a future solution of the problem. The strategic environment for the Republic of Cyprus (RoC) and the Turkish Republic of Northern Cyprus (TRNC) is permissive, because the message sent by the international system for reunification does not require the use of material means. The leaders of the two communities play a key role, given that strategic political culture in small states such as the TRNC is not developed and state-society relations are underdeveloped. However, domestic level actors such as political parties and civil society organizations can play a role in influencing the leaders’ image regarding these opportunities. The data comes from existing studies, the Greek Cypriot and Turkish Cypriot digital media resources and valuable relevant information from semi-structured interviews with experts from both sides.

**Keywords:** International Relations, Cyprus, Securitization, Neo-classical Realism, Theory synthesis

## **The Discovery of Natural Resources and the Escalation of the Cyprus Conflict: Using Q-Methodology to Explore the Disputants' Perspectives on the Causal Mechanisms**

*Vasileios P. Karakasis<sup>1</sup>*

<sup>1</sup>Lecturer & PhD Candidate at the University of Leiden, The Netherlands

### **Abstract**

The gas discoveries south of Cyprus have become a new twist of the Cypriot saga. Turkey has promulgated repeated warnings against the Greek-Cypriots' energy program and dispatched seismic vessels to initiate explorations in areas encroaching the Exclusive Economic Zone of the Greek-Cypriot administered Republic of Cyprus. My research question is: what is the impact of the gas reserves on the escalation of the Cyprus conflict, based on the Greek-Cypriot and Turkish-Cypriot discourses? During the last two decades, researchers from the fields of sociology, political economy and conflict studies have conducted empirical studies to assert a positive correlation between the discovery of natural resources and the risk of conflicts' onset and duration. Most of them have coined this phenomenon as "resource curse". Theoretically motivated by this literature, my exploratory study illuminates its plausibility in the single-case of Cyprus. I adopt discourses as my conceptual framework to endogenize agency by prioritizing the agents' views regarding the conflict and the natural resources. To uncover the contrasting Greek-Cypriot and Turkish-Cypriot discourses, I apply Q-methodology, a forum tailor-made to "measure" human subjectivity concerning this topic. Its application unfolds in four distinct stages: formulating the (1) statements under inspection through open-ended interviews or natural discourse in the language of Q-methodology (2) their reduction to a manageable volume (Q-sample), (3) the selection of the participants (our P-Set) and sorting procedure of the statements against a particular grid (Q-sort technique) and (4) the factor-analysis. Factor-analysis generates five distinct and competing discourses: (a) "gas boosting our geopolitical standing" (b) "pipe-dreams and imported national myths" and (c) "resentment matters" (from the Greek-Cypriot side), (e) "gas stimulating political equality" and (f) "micro-politics" (from the Turkish-Cypriot side). The contrast between these discourses addresses my research question. Based on these findings, I recommend to EU officials the establishment of an EU Eastern Mediterranean Energy Diplomacy Task Force and an East Med Environmental Regime to discuss the environmental challenges stemming from the extraction of the gas reserves, as well as the promotion of Track II diplomacy to hammer-out common Cypriot strategies about the future monetization of the gas reserves.

**Keywords:** Q-methodology, resource-curse, Cyprus conflict, gas reserves, EU strategy

## China's Emerging Role as Commercial and Economic Partner of the EU

*Christina D. Meleouni*<sup>1</sup>

<sup>1</sup>Political Scientist – International Relation Specialist, Greece

### Abstract

It took about four decades and several reforms to make China grow its economy and emerge as one of the largest economies internationally. Indeed, the People's Republic of China has, within a short period, been able to grow its economy to become the second-largest economy in the world after the US. Mao Zedong's shift to the US and the West was the beginning for China to emerge from the isolation that would lead it to an open international economic system. After Mao, Deng Xiaoping, as well as his successor Presidents, continued the controlled opening of China's economy to the market economy, private initiative, and foreign investment, resulting in the development of a large global economy.

Indeed, opening up the economy to foreign markets has led China to work with the United States and subsequently with the European Union. Also, with the approval of the United States, in December 2001, China was admitted to the World Trade Organization (WTO) where it offered several economic advantages. China's rapid growth has led it to work beyond the US but also with the European Union. The United States is considered to be the EU's main trading partner, but in recent years China's intense trade and economic activity in the region has been evidenced, either by bilateral or multilateral agreements.

Finally, the question that arises from this cooperation is whether China will be able to play a leading role in the EU and whether it will be able to surpass the US at some point. This study examines China's economic and trade activities mainly in the Central European and Western Balkans to analyze China's role in the region where they are contributing.

**Keywords:** EU, China, Central Europe, economic-trade relations

## **The Economic Diplomacy of the European Union Towards Western Balkans During and After the Financial Crisis.**

*Emilio Çika<sup>1</sup>, Kriton Kuçi<sup>2</sup>*

<sup>1</sup>Dr., Mediterranean University of Albania, Albania

<sup>2</sup>PhD cand., Mediterranean University of Albania, Albania

### **Abstract**

The main objective of this paper is to analyze the economic diplomacy of the European Union during and after the economic crisis of 2008 towards Western Balkans. European Union as one of the leading political and economic actors in the regional and international arena, plays a very important and crucial role in the global markets.

The European construction has been very difficult and in the past has faced many problems but as the economic and monetary crisis began in 2008, EU had to adapt in the new economic order or to risk even its foundations. EU had to reconsider the role of the different domestic key institutions such as European Commission and European Council and at the same time to reposition its self as a leading organization in the international arena. EU as an international organization and the member countries had to develop common positions in order to avoid future economic, political and social problems not only within the EU structure but for the countries that are in the integration process as well.

The fact that EU is the largest common market is widely known and as such it is a key player in shaping international agendas, therefore EU has become a model for countries seeking membership. The EU and its member states are in a duality and they don't have a common approach towards the enlargement and especially in relation to the Western Balkan countries. Therefore, these counties -except Croatia- are obliged to pay lot off efforts in order to meet the necessary criteria in order to join EU. Economic diplomacy and economic cooperation could be a valuable and necessary path for Western Balkans towards their integration process in the EU.

**Key words:** Economic Diplomacy, Economic Development, Western Balkans Economic Integration.

## Cosmopolitan Politics in an Age of Global Risks: The Religious Factor in the EU Foreign Policy

*Chrysa K. Almpani*<sup>1</sup>

<sup>1</sup>PhD Candidate in Sociology, Religion & IR, HFRI Fellowship PhD Grant (no. 2401)  
Aristotle University of Thessaloniki, Greece

### Abstract

Ulrich Beck's sociological analysis outlines that the idea of a cosmopolitan state in civil society form is aimed at imagining and realizing a resilient diversity. Civil society's agenda surrounds itself with the aura of human rights and global justice and struggles for a new grand narrative of radical-democratic globalization, expressing a 'cosmopolitan realpolitik' in an age of global crises and risks. Korzec's theoretical approach (1993) recognized human rights as a "global religion", focusing mainly on their institutional dimension. In the ambivalent times of 'second modernity', however, the continuing human rights' violations in the name of religion reveal that the real challenge remains the universal belief in everyone's right to a dignified and well-protected life.

According to a recent in-depth analysis of the European Parliament (2017), the last two decades the European Union has been confronted with diplomatic crises in which the religious dimension has been key. Referring to the multiple ways in which religion may affect the balance of power at international level, Fox (2006) argues that the religious factor has the dynamics to confer legitimacy to political decisions, to influence the leaders' world-views and shape the environment of policy-making actors, while also allowing religious conflicts to surpass national borders and turn into international issues.

The aim of this paper is to identify the significance of religion as an emerging field in EU foreign policy making. Within this framework, the main questions addressed focus on the extent to which the geopolitical and societal changes at global scale 'sensitize' the EU external policies in religious matters and whether the incorporation of religious dimension at policy level could reinforce the Union's position as a global actor. Moreover, the analysis constitutes an effort to illuminate the intertwining of religious factor with the fields of diplomacy, conflict resolution and reconciliation processes in an interconnected, cosmopolitan world.

**Keywords:** Religion, European politics, Foreign policy, EU policy-making, Cosmopolitanism

## **Peace in the Eyes of the Beholder: How the UN Security Council Perceives Sustainable Development Goal 16**

*Georgia Apostolaki<sup>1</sup>*

<sup>1</sup>Researcher at the Hellenic Institute on United Nations Affairs , Coordinator at Europe Direct Informational Centre hosted by the Hellenic Foundation for European and Foreign Policy (ELIAMEP)

### **Abstract**

2015 was a very important year for Sustainable Development, since the new strategy of the United Nations (hereinafter UN) was launched, introducing the Sustainable Development Goals (hereinafter SDGs). This strategy comes to replace the Millennium Goals and to usher a new area for sustainable development around the world. Towards this goal and for the first time, there is a Goal dedicated to peace. Indeed, Goal 16 is titled “Peace, Justice and Strong Institutions” (hereinafter SDG16). Although it might seem obvious, there is no clear picture of what this Goal is and what actions it entails, especially when it comes to such a complex matter.

This paper will try to present a primary analysis of how the UN Security Council (hereinafter SC), the body responsible for peacekeeping around the world, perceives SDG16. The main question that this paper will try to answer is what the new elements that SDG16 brings or could add to the preexisting UN strategies and policies concerning peace consolidation are. The first part will entail the thematic analysis following the example of Braun and Clarke (2006) of all documents produced by the Security Council between 2015 and today, as it is the most crucial UN body when it comes to fostering, enforcing and consolidating peaceful societies. The second part will entail the results of the thematic analysis and the narrative that the UNSC builds, when referring to peace under the SDG16. After this is established, the analysis will focus on what is the added value of this new narrative of peace and why it was deemed necessary to be added to the efforts already taken by the UNSC towards peace around the world. The analysis will be based on “policy narratives” by Fischer (2003), Fischer and Forester (1993), Roe (1994) and Stone (2011).

By focusing on the UNSC’s perspective of peace under the SCG16, we can better understand the complex environment that the UN and other supranational organizations operate in and to comprehend the UNSC’s decisions and reaction towards conflict in the modern world.

**Keywords:** UN Security Council, SDG 16, policy narratives, peace

## EU Geopolitics in Southeastern Mediterranean

*Christos S. Argyriou*

### Abstract

EU is already facing an increased number of challenges on different fields (environment, immigration, economy, energy ect). The part of energy though is inextricably linked with its foreign relations and geopolitics. U.S.A, Germany, Greece, Cyprus, Italy, France, U.K, Israel, Egypt and Turkey are all, directly or indirectly, absorbed in a vortex with uncertain yet, results.

Focusing on environmental issues is essential in order to understand geoeconomy and the importance on energy fields, such as the one within the Cypriot EEZ. For instance very important data we collect from the “Earth Overshoot Day” which is earlier every year, so if we keep consuming earth’s resources earlier every year, it’s easy to imagine why oil and gas fields have already become of major importance.

Another field we should be focusing on is economy. The fact that both EU and Turkey facing the some problems in energy brings a mutual understanding with conflicting interests though. EU imports more than half of its energy consumed (69%). As a result EU’s import bill is more than \$1bn per day. The same problem applies to Turkey which paid \$43bn (2018) for its energy needs. Turkey’s aggressiveness isn’t surprising at all.

Where the “European energy security strategy” will lead? The energy security stress tests showed that if Russian or Ukrainian gas is disrupted there is going to be a substantial impact on the EU. Short and long term measures adopted by every member state, doesn’t include the Eastern Mediterranean region.

USA is trying to diversify EU’s energy dependence from Russia but at the same time Germany agreed to Nord Stream2 pipeline a decision that splits Europe. That’s a reason why USA is trying to make Eastmed project viable. The strategic alliance formed between USA, Greece, Cyprus, Egypt and Israel is a good start but still there are many obstacles to overcome such as the final results of the blocks. Is there going to be another “zohr” like field within Cypriot EEZ that will make it worth for the energy giants to proceed? Is the Eastern Mediterranean region going to be stable making the Eastmed project attractive to a consortium needed for such a project estimated \$7bn?

Turkey is the key to answer all these questions. Turkey cannot afford not be part of such a project. The new efforts starting again on September will finally lead to a solution I believe. Compromises will be made by both sides, but the question remains if there is going to be a bi-zonal federation or a co-federation. If Turkey shows good will to resolve the island’s decades-long division then Eastmed pipeline might not be needed anymore.

**Keywords:** Geopolitics, Southeastern Mediterranean, EEZ

**PUBLIC POLICIES IN EDUCATION, HIGHER EDUCATION & TRAINING**



## European Governance in Education: Policy Learning Through Projectization and the New Competences for the European Teacher

*George Pasiás<sup>1</sup>, Antonia Samara<sup>2</sup>*

<sup>1</sup> Professor, National and Kapodistrian University of Athens, Greece

<sup>2</sup> Headteacher, Maraslion Experimental Multigrade Primary School of the National and Kapodistrian University of Athens, Greece

### Abstract

During the last decades and especially after the Lisbon Strategy, issues of governance in education are crucial. EU has gradually mastered soft governed areas, mainly through the application of the Open Method of Coordination. Today, we are witnessing the overall domination of corset policies in education, in which the various educational partners, from nation states to institutions, seem to be willing to fit. On the other hand, a new notion in EU educational discourse has prevailed during the last decade, namely that of competences, as an idea that includes knowledge, skills and attitudes in a dynamic of lifelong learning. The paper explores ideological perspectives of the competence society as it is perceived through EU papers of the last decade, as well as the way which this competence society is built through alignment. In this context we link it to the creation of the “competence for self-government” of educational organizations and even education professionals, through setting goals, planning action, self evaluation, participating in networks and measuring achievement.

All the above are implemented from the national policy level to the level of the school. Therefore we try to explore the implementation of EU governance inside school, with the teachers playing a central role. We focus on projectization in education as a means of implementing educational change. For this to be realized we are investigating the role of teachers, namely the role of teachers as agents of change and of policy implementation via projectization, which is possible through modes of evaluation, self evaluation, specific target setting and performativity. These all set new competences for teachers and call for the building of a new lifelong learning teacher in a school that functions as a learning organization. We conclude by arguing that such education professional can also understand, interpret and reflect on educational policy, and act upon it, by customizing practices to the specific needs and capabilities of the national/local environment, the school community and his/her students accordingly.

**Keywords:** education governance, competencies, open method of coordination, projectization, lifelong learning teacher

## **Regime complexity and SDG4 for Quality Education: the EU's strategic response**

*Foteini Asderaki<sup>1</sup>, Varvara Dilari<sup>2</sup>*

<sup>1</sup>Associate Professor, University of Piraeus, Jean Monnet Chair on European Union's Education, Training, Research and Innovation Policies

<sup>2</sup>Msc on International and European Policies on Education, Training and Research, University of Piraeus.

### **Abstract**

EU has supported the implementation of the 2030 SDGs Agenda adopted in 2015 by the UN General Assembly as part of its EU 2020 Strategy and EU Global Strategy (European Commission, 2016). The 2030 Agenda aims to accomplish universal quality education as a stand-alone goal, in order to make education a global concern. The implementation of the SDG4 "Quality Education" requires the development of new global governance forms, which will coordinate all the relevant international regimes and actors such as International Organisations, the EU and other regional initiatives, national governments and various stakeholders (Asderaki and Dilari, 2018). UNESCO, being at the centre of this process, has been mandated to lead and coordinate SDG4 "Education 2030 Agenda" and the Framework for Action. However, the EU and its member states have played a crucial role regarding the formulation, the adoption as well as the realization and the monitoring of the SDG4. This article, based on the international regime complexity theory (Raustiala and Victor 2004, Alter and Meunier 2009, Biermann et al.2009, Keohane and Victor 2011, Oberthür and Stokke 2011; Orsini, Morin, and Young 2013, Betts 2013, Alter and Raustiala 2018, Asderaki 2019), examines the regime complex of education, centered around UNESCO. It focuses on the "division of labor", the overlapping and the conflict of interests and norms between the various regimes. Moreover, it examines the EU's strategic response, including EU-UNESCO interaction, as well as the norms, the policies and the tools of EU's educational regime, aiming at promoting its priorities and its global actorness.

**Keywords:** Regime complexity, quality education, EU

## **Greece as an International Hub for Higher Education: Opportunities, challenges and recommendations for Greece in the International Student Market (ISM)**

*Cheryl Novak<sup>1</sup>*

<sup>1</sup> MSt, University of Cambridge

### **Abstract**

The level of internationalization of higher education institutions in any country is a key indicator of the degree of competitiveness of its institutions. While there are many qualitative elements to be considered when assessing the level of internationalization of any institution, the most widely accepted and quantifiable element is the International Student Market (ISM). This short intervention offers information about the current state of internationalization of higher education institutions in Greece, viewed within the framework of the International Student Market (ISM), and presents a view on the opportunities, challenges and recommendations for Greece on how it can move towards increasing its share of the ISM, thus improving the level of internationalization of the country's institutions, the rankings of its institutions, and the promotion of economic growth in the country through higher education.

**Keywords:** Higher education, Greece, International Student Market

**PUBLIC ADMINISTRATION, POLICY-MAKING AND GOVERNANCE**

## **The policy for recruitments in the Greek public sector (2016 – 2019)**

**Ivi Mavromoustakou<sup>1</sup>**

<sup>1</sup>Professor, University of Crete

### **Abstract**

The 2016 annual report by ASEP welcomes the restart of recruitment in the public sector after its prorogation because of the economic crisis and the reduction of the recruitments/ retirements ratio. This paper examines the hiring policy in the public sector since 2015 that the report presents until the publication of the L. 4549/2019, primarily through the main annual reports of ASEP, focusing on the number and the kind of the notices of vacancy, as well as the positions included in them. Furthermore, it explores the institutional changes that arose during this period, focusing both on the procedures and the criteria for the appointments.

## **Fiscal Austerity and Organizational Change in Greek Local Government: Performance improvement without measurement?**

*Sifis Plimakis<sup>1</sup>*

<sup>1</sup>Assistant Professor, Department of Political Science and International Relations, University of Peloponnese

### **Abstract**

The scope of the paper is to evaluate the impact of strategic planning and performance measurement on the performance of municipal services in Greek local government. Performance measurement introduction has been one of the major pillars of the recent local government reform initiatives, start back in 2007. Furthermore, strategic planning and performance measurement introduction were further promoted from the Greek government during the years of the recent financial crisis facing Greece since 2011. Local government reform programs, that despite their contribution of the resolution on the long standing centralization and democratic deficit problems facing Greek Local government, their impact on services performance was marginal. A limited impact on municipal services performance reflected a lack of an effective national policy for the promotion of strategic management and performance measurement and the limited compliance of local government authorities with their tools and models.

Based on the combination qualitative and quantitative data, this research thus, evaluates the impact of performance measurement tools on municipal services performance and the promotion of organizational change. Research's sample was 34 municipal authorities, experienced with the adoption of strategic planning and performance measurement between the years 2015 and 2019. As part of the research 128 interviews with local government officials and employees were conducted and more than 200 local government acts, decision and reports were analyzed. Strategic planning and performance measurement initiatives were analyzed regarding the drivers and obstacles on their adoption, municipal authorities' implementation patterns and variations, employees' views and attitude regarding performance measurement and finally its impact of services efficiency, quality and effectiveness.

**Keywords:** Performance measurement, organizational change, governance reform local government, strategic planning,

## Governance Reform and Organizational Change in Greek Public Sector: The case of Public Employment Service

*George Karachalios<sup>1</sup>, Sifis Plimakis*

<sup>1</sup>Public Employment Agency (OAED)

<sup>2</sup>Assistant Professor, Department of Political Science and International Relations, University of Peloponnese

### Abstract

The scope of the paper is the evaluation of the EU structural funds impact on governance structures performance in Greek Public Administration, focusing on the case of Greek Public Employment Service (OAED). Through the in depth analysis of the employment policy implementation in Greece, the paper is attempting to assess the real impact of EU programs on public sector reform. Based on new governance theory, paper analyzes the impact of the EU structural funds on the promotion of organizational change in OAED and the use of new governance tools, such as decentralization, partnerships and networks, on employment policy's implementation. Paper's overall goal is to assess the conditions under which collaborative governance models could lead to the improvement of employment services' effectiveness and contribute to the emergence of a new model of employment policy in Greece, based on decentralization, collaboration and performance management. Research's results are based on the analysis of quantitative data from the implementation of EU Structural Funds in employment policy and OAED, as well as on a field research carried out in 2018 - 2019, including 29 interviews and the completion of 88 questionnaires.

**Keywords:** organizational change, public governance reform, employment policy, public sector performance

## **Social Security, Social Welfare in Greece and Europe at the Crisis Period, 2009-2019**

***Konstantinos Memos<sup>1</sup>***

<sup>1</sup> Laboratory teaching staff, Department of Social Policy, Panteion University

### **Abstract**

In the sphere of modern developments of the last 10 years, the political phenomenon is shifting to face the global challenges in the economy and therefore in the society.

The intense manipulation of stock markets, of global economy and of even some countries since 2010-2011 has had a negative impact on the ideology and policies of individual governments with negative effects on local societies and especially on citizens' welfare, welfare state, work, social life, insurance and health in particular those where financial adjustment programs have been and are being implemented.

The Social Security System in Greece was in crisis long before the 2009 crisis. In 1980, the first deficits appeared in many funds. A system with the highest insurance contributions at European level which faces serious sustainability problems. Legislative developments during the crisis have made the Insurance System worse, and in order to ensure its viability, the policies in place have focused on increasing revenue and reducing costs, therefore highlighting unfairness among the currently insured and those of future generations. In Europe supplementary insurance (occupational funds) works in addition to Social Security and has ensured higher levels of benefits and social efficiency.

The implemented economic policy in Greece, as in other European countries, has led to a reduction in the public deficit through the reduction of wage pensions, social spending and, in general, the decline of the social state. Social spending is seen as consuming and the welfare state is further shrinking.

**Keywords:** Social Security, Social Welfare, Social Policy

**FINANCE AND INVESTMENTS**

## **Peer-to-Peer Lenders' motivations and risks perceptions in cross-border investments in Europe**

*Efstathios Karpouzis<sup>1</sup>, Nikolaos Daskalakis<sup>2</sup>, Maria Psillaki<sup>1</sup> and Christos Staikouras<sup>3</sup>*

<sup>1</sup> University of Piraeus. Email: karpouzis@unipi.gr

<sup>2</sup> University of Brighton.

<sup>3</sup> Athens University of Economics and Business.

### **Abstract**

Following the global financial crisis of 2008 and the subsequent credit rationing that occurred, fintech lending and more precisely peer-to-peer (p2p) lending can be considered as an alternative source of finance for many firms and consumers. This paper examines users' perceptions of motivations and risks in p2p lending and how these are related to cross-border activity. We use survey methodology to collect responses to a detailed questionnaire sent to p2p lending platforms' users across Europe, allowing us to differentiate between the UK and the rest of the EU. Results show that UK respondents seem to care more about higher returns and less about interest/excitement when investing via p2p lending, when compared with non-UK respondents. We also find that all risks score lower in the case of the UK respondents, a strong indication of higher levels of trust on the entire industry in the UK. On cross-border activity, we find that non-UK respondents are much more willing to invest abroad when compared with their UK counterparts and that the cross-border p2p lending flow seems to be platform-based and not project-based. Our results have important implications for all p2p lending participants, such as fund raisers (consumers and SMEs) and regulators.

**Keywords:** peer-to-peer lending, risks and motivations, cross-border

**JEL:** G00, O30

## **Financial contagion and volatility spillover: An exploration into crude oil future market and 3Y, 4Y and 5Y CDS markets**

*Konstantinos Tsiaras<sup>1</sup>*

<sup>1</sup>Department of Economics, University of Ioannina, University Campus, 45110 Ioannina, Greece. Email: konstantinos.tsiaras1988@gmail.com

### **Abstract**

This paper seeks to investigate the volatility transmission from crude oil future contracts to the private CDS markets of Germany and France. I quantify volatility spillover effects by employing a dynamic conditional correlation (DCC) Generalized ARCH (GARCH) model. The under investigation period is during 2011-2018. I focus on the CDSs of the biggest banks in Germany and France namely: Société Générale and Deutsche Bank AG using 3-, 4- and 5-year maturity CDSs. According to dynamic conditional correlations, I find evidence of contagion for the pairs of markets Societe Generale CDS 3Y-Crude oil futures, Societe Generale CDS 4Y-Crude oil futures and Societe Generale CDS 5Y-Crude oil futures for two time periods (10/2014-12/2014 and 04/2017-11/2017). The results are of interest to individual investors, which diversify their portfolios through international derivative investment.

**JEL codes:** C58, C61, G11, G15

**Key Words:** Financial contagion, Global Financial Crisis, cDCC-GARCH model, crude oil future market, CDS market



## The Political Economy of Cryptocurrencies

*Antonis Ballis*<sup>1</sup>

<sup>1</sup>PhD Fellow, Athens University of Economics and Business, School of Business, Department of Accounting and Finance. Email: aballis@aueb.gr

### Abstract

It took the earth's population a hundred thousand years to reach one billion people. Then astoundingly, it took only about a hundred years to double the population to two billion. After that, it took a mere fifty years for the population to double again to four billion, and now we are nearly at eight billion. This journey of the earth's population is well-known to academics and the layman as exponential doubling. The universe of financial markets consists of a wide set of assets that offer potential investors almost countless investment opportunities. From time to time new financial assets and instruments are born which ultimately attract capital and usually attention. The latest example of such a birth is the cryptocurrency market which started in 2009 with the – exotic and relatively mysterious at the time – but well-known nowadays Bitcoin. Since its moment of creation, the cryptocurrency market has exhibited a similar explosive expansion as in the case of the earth's population. This recent proliferation of cryptocurrencies even though has been accepted as a boon by users, it might prove to be a bane for governments. As a result, already, governments around the world have taken steps either to regulate cryptocurrencies or to even discourage and ban their use. Connecting this to Bartlett's beaker example, where a dividing – by the minute – bacterium is placed at a beaker at 11:00 p.m. and by 11:59 p.m. the beaker is only half-full, only to find itself completely full just one minute later at 12:00 a.m., it would be wise to contemplate the idea that maybe the global economy is only a minute away to cryptocurrency domination. The aim of this analysis is to identify the effects that government decisions can have to cryptocurrencies, to examine whether it is possible to find a monetary equilibrium in which cryptocurrencies can co-exist with official fiat currencies and finally to portray whether government policies are more difficult to be implemented as the users interest and fixation in cryptocurrencies grows.

**Keywords:** Bitcoin; Cryptocurrencies; Digital Currencies; Political Economy

**Shadow Economy:  
Definitions, Terms & Theoretical Considerations**

*Paraskevi Koufopoulou<sup>1</sup>, Colin C. Williams<sup>2</sup>,  
Athanasios Vozikis<sup>3</sup>, Kyriakos Souliotis<sup>4</sup>,*

<sup>1</sup> Deputy CEO, KAT General Hospital of Attica, PhD (c), Department of Economics, School of Economics, Business & International Studies, University of Piraeus.

<sup>2</sup> Professor of Public Policy, School of Management, University of Sheffield, Sheffield, UK.

<sup>3</sup> Associate Professor, Department of Economics, Director of Laboratory of Health Economics & Management, School of Economics, Business & International Studies, University of Piraeus.

<sup>4</sup> Associate Professor, Department of Social & Educational Policy, School of Social & Political Sciences, University of Peloponnese.

**Abstract**

The last decades, many scholars highlighted the shadow economic activities, regarding their disadvantages (unemployment, impoverishment etc) and advantages (intensifies competition, flexibility in employment etc). During the financial crisis, informal activities rose in noisy way, which triggered the development of special definitions to describe a wide range of actions which in turn have gradually configured and updated the content of the shadow economy term. We present the theoretical background of the shadow economy term, by selecting the main worldwide literature published from 1973 to 2018. In order to capture the key conceptual terms of reported determinations in the literature, we designed a research protocol. For our purpose, we have used several databases such as Google Scholar, EBSCO, IDEAS, NBER, IOS Press, SCOPUS and Elsevier, as well as books and scientific journals and we found that 2,612 studies are related to shadow economy. Finally 149 studies have been used. According to our review 40 adjectives were identified, which shows that 19 terms were not detected in the literature, describing any possible undeclared economic activities. Furthermore, we have found that some terms (which came up, mostly, during economic crisis) revealed the multiple dimensions of shadow economy, e.g. as tax havens, offshore financial centers, money laundering, shadow banking etc. Taking into account this analysis it would be useful for the scholars to choose the appropriate term in each case and to design and implement the indicative method to estimate the size of the shadow economy.

**Keywords:** shadow economy, shadow banking, tax havens, offshore financial centers, tax evasion.

**POLITICAL ORIENTATION, POPULISM AND**  
**EUROSCEPTICISM**

## **“Populism in the Birth-Place of Democracy: The Peculiar Case of Greece”**

*Dr Spyridon Plakoudas<sup>1</sup>*

<sup>1</sup>Assistant Professor of International Politics and Security at Rabdan Academy

### **Abstract**

The debt crisis in 2010 radically transformed, without doubt, politics in Greece. The extremely unpopular austerity policies triggered a severe internal polarization which quickly translated into anti-German mass hysteria, vitriolic anti-EU rhetoric and scathing anti-austerity populism. In fact, the current government was elected on the basis of populist rhetoric and even dragged the country into an ill-conceived plebiscite in 2015 about the relation between Greece and the EU. But did populism simply appeared out of nowhere in the political arena of Greece after 2010? Or did populism already exist and was just exacerbated by the austerity policies? This article continues on the research of a previous (published) paper about the effects of the debt crisis on politics in Greece and will essay to explain how populism (a rather old phenomenon in Greece) assumed a new role and position in the cradle of democracy after 2010 – long before other (Western) countries (e.g. Italy) succumbed to this new menace.

**Keywords:** European Politics, Populism, Debt Crisis, Austerity Politics, Modern Greece, Democracy

## **Conceptual and empirical analysis of modern Euroscepticism: The cases of France, United Kingdom and Italy**

*Georgios Nastos<sup>1</sup>*

<sup>1</sup>Political Scientist MSc, University of Crete

### **Abstract**

Understanding the multidimensional nature of euroscepticism is not only a matter of normative issues concerning efforts to deepen European integration, it also raises issues of political behavior, identities, public policies, democratic legitimacy, economy, ideology, and other areas. Euroscepticism is a heterogeneous and dynamic phenomenon, which is not defined as a concept by a commonly accepted theoretical framework. In a wider context, it refers to the opposition to the European Union, either in its entirety, as a supranational organization, or in its existing structure, form and political direction. Moreover, euroscepticism, in different interpretative contexts, is something that is expressed in a political system both on the left and right of the political spectrum. The economic and financial crisis, along with the fiscal adjustment policies that followed, on the one hand, and the refugee crisis on the other, contributed to the increase of negative attitudes towards the EU from its citizens and provided the space for the development of eurosceptic parties and groups, invested with a populist and nationalist agenda. The purpose of this study is to outline the modern parameters of euroscepticism within the EU. After the theoretical framework and the necessary conceptual clarifications on the term of euroscepticism, this paper examines three case studies. The cases of France, the United Kingdom and Italy are studied in relation to the development of euroscepticism in the past few years, both within the party system and in that of public opinion. The findings show that euroscepticism is largely related to issues of sovereignty, identity, and to the degree of confidence in the national political system. Furthermore, euroscepticism is related to the two major crises the EU has been called on to face and which have severely damaged its image - the economic and refugee crises. The methodology includes bibliographic research and the secondary analysis of quantitative data through Eurobarometer surveys on trends in public opinion towards the European Union.

**Keywords:** Euroscepticism, European integration, European Union.

**ISSUES OF EDUCATION POLICY AND SOCIAL COHESION**

**On Ethics and Values in Education:  
Exploring an Open Educational Model for Ethical Literacy**

*Elena Xenil*<sup>1</sup>

<sup>1</sup>CARDET – Centre for the Advancement and Development of Educational Technology

**Abstract**

The various radical changes that have taken place in recent years are affecting important aspects of social life. One solution to mitigate the negative effects of these changes could be to invest in an educational model that is based on the values of respect for diversity, equality and responsibility. Within this model there are attitudes, predispositions, and behaviors that can and should be experienced from an early age (Stiles, Jernigen 2010; Jolles, Crone 2012), aiming at forming an integrated personality, focusing on three pillars: respecting the self (myself), respecting the others (others) and responsible behavior and action (the environment).

In an attempt to develop an open model based on Ethical Literacy, as undertaken in the framework of the EU funded project *AVAL - Added VALue Learning for Preschool Teachers & Pedagogical Coordinators*, a thorough investigation of the dominant ethics and values in education emerged as an imperative necessity in the research process. Data obtained from the structured questionnaire issued in the first half of 2017 to 17 pre-primary and primary school teachers in the Cypriot context, highlighted that teachers emphasize the importance of the following values in education: ethics, honesty, justice/ critical thinking reflection. Teachers believe that these can be successfully taught and stress that visual and audio media, educational platforms and presentations are the most effective teaching and learning materials. They also underline that role play, teamwork, and extensions to everyday life are the most effective methodologies for teaching ethics and values.

The results of the study are compared with the data from other European countries in the AVAL partnership, while the pedagogical implications for the values in the proposed model will be tackled on the grounds of a model which seeks to respond to the need of enabling future generations to live in a more open and critical literacy developed society, with children being capable of building solid moral foundations and values that will guide their lives and future.

**Keywords:** ethics and values in education, ethical literacy

## At the dawn of the fourth industrial revolution: challenges and opportunities of artificial intelligence in education with the aim at fostering sustainable development

*Pavlos Petidis*<sup>1</sup>

<sup>1</sup>Undergraduate Student, Department of Political Science and Public Administration, National and Kapodistrian University, Greece

### Abstract

Artificial Intelligence (AI), in the core of which lies the concept of the excessive use of digital technologies and algorithms, constitutes one of the engines that drive the Fourth Industrial Revolution. As rapid advances in machine learning (ML) algorithms increase the breadth, scope and scale of AI's deployment across all aspects of daily life, leaders and policy-makers acknowledge the importance of incorporating AI technology in the field of education aiming at improving educational equity and quality. Purpose of this paper is to examine the prospective impact of Artificial Technologies to the study process through new teaching and learning methods, to identify the possibility of emerging opportunities in the educational landscape and to propose viable policies so as to pave the way for sustainable use of AI in the respective field of education.

The first section of this paper analyses the nature of AI and how can be used to improve learning outcomes on the basis of educational content, innovative teaching methods, technology enhanced assessment and communication between student and lecturer. Pertaining to learning outcomes, concrete examples from countries such as US, Brazil and South Africa are examined on access to education and teacher support. The second section explores the different means by which governments and educational institutions are rethinking and reworking educational programmes. In the last section we address, on the one hand, the policy implications that should be part of the global and local conversations regarding the opportunities and risks of introducing AI in education and, on the other hand, propose the development of comprehensive national AI frameworks governing its role as tools instrumental to achieving sustainable development through the lens of education. We will emphasize on the restructuring of the existing curricula on the new AI-powered context so as to achieve the sustainable development goal of quality education.

**Keywords:** Artificial Intelligence, Education, algorithms

## **The pseudo-dilemma of Autonomy versus Accountability in Higher Education Policy Reforms in Greece**

*Vaia Papanikolaou<sup>1</sup>, Yiannis Roussakis<sup>1</sup> and Panagiotis Tzionas<sup>2</sup>*

<sup>1</sup>Dept. of Special Education, University of Thessaly, Greece.

<sup>1</sup>Dept. of Special Education, University of Thessaly, Greece.

<sup>2</sup>Dept. of Production Engineering and Management, International Hellenic University, Greece.

### **Abstract**

Autonomy defines a group's right to self-government or self-rule. Institutional autonomy is about the freedom to determine curricula, research directions, selection of academic staff and students, as well as the freedom to question received wisdom and to put forward new ideas and controversial opinions. However, autonomy granted to universities is not meant to promote the particularistic interests of a few individuals.

Accountability refers to the responsibility of university administrators to provide reports of their stewardship of public funds. It helps to align institutional priorities with state goals, allow stakeholders to view their progress, and provides a basis for making policy decisions with transparency. However, management appropriate to manufacturing companies may not be effective in the administration of knowledge generation and transfer in university environments. It is a source of great concern to see how certain universities are being dominated by bureaucratic structures.

Accountability can be perceived, in a negative sense, to restrict autonomy, influencing institutional behavior as an external force through the reporting process about how resources have been used. This results to tension building, as academics see themselves alienated from their moral and spiritual duties. Hence the resulting dilemma of choosing between autonomy and accountability.

This paper presents the results of a survey among Greek academics, expressing their views on autonomy versus accountability issues, together with the results of a set of interviews with a European group of academics on the same matter. Additionally, three framework laws governing Greek educational policy reforms for the last 35 years are examined with respect to their autonomy and accountability characteristics.

It is shown that university autonomy is not an end in itself, but a means to achieving the public's goals for universities. Achieving a harmonious balance between autonomy and accountability depends on historical background, accepted norms and practices, and political economy. Thus, the choice between them is a pseudo-dilemma and they should not be considered as parts of a Faustian bargain, where the spiritual value of autonomy is exchanged for some worldly material benefit such as funding. In this sense, a fusion of academic mission and executive capacity is the ultimate goal.

**Keywords:** Educational policy, autonomy, accountability, university



## The challenges of forging a new policy for an inclusive religious education in Greece

*Dr Zoe Michalopoulou*<sup>1</sup>

<sup>1</sup>Aristotle University of Thessaloniki, Greece

### Abstract

The resettlement and inclusion of migrants and refugees in host societies is an important issue, which is very much prominent on the social sciences agenda. This is not surprising when taking into account that only in Europe in 2011 the global number of refugees was approximately 1.5 million people (UNHCR, 2011). The significant size of this population means this is not a topic, which social scientists can afford to leave under-researched. Moreover in the past years there has been an evident increase in migration flows worldwide, due to the on going wars and socio-political tensions in the Middle-East and Africa. Especially after 2016, when FYROM closed the borders to refugees and migrants, thousands of people have been left stranded in Greece and therefore have to resettle in the country.

Migrants and refugees originate from various countries and socio-cultural groups. Inter-cultural tensions may arise, while the tolerance of the host society is put to the test. Due to the above rapid social developments, the educational system should be able to confront the new challenges and focus on ways to form a more inclusive society.

The proposed paper argues that this is the main reason a new policy regarding religious education should be considered. It should be noted that in the current Greek context, the existing legislative framework and the corresponding policies do not adequately accommodate the religious freedom of the incoming populations. Furthermore, when the Greek Government tried to reform the program of religious education in 2016, the Council of State (Symvoulío tis Epikrateias) annulled the said legislation, citing that it violates the religious freedom of the majority of the population i.e. Christian Orthodox (decision number 660/2018).

The paper will analyze the different policies concerning religious education in Europe, that faces similar problems, and will try to propose a new one for the Greek schools taking into consideration not only the social issues that have arisen during recent years but also the existing constitutional framework regarding religious freedom, as it has been interpreted by the Greek courts.

**Keywords:** migration, educational policies, integration policies, religious freedom

## **The need to belong as a psychological drive in the process of reaching social cohesion**

*Despoina Limniotaki<sup>1</sup>*

<sup>1</sup>MSc Group Processes and Intergroup Relations, Liberal Alliance Steering Committee Member, Greece

### **Abstract**

Cohesion refers to the process by which the members of a group manage to find common ground and become aware of how their social survival and prosperity are molded out of the same efforts and the same concerns. Yet cohesion is a byproduct of successful partnerships: it cannot be forced from the outside nor can group identity and intergroup relations strengthen through sheer communication of ideas or the enforcement of policies. The challenges of the globalized world together with the politics of oversimplification - especially regarding history and the past - often lead to ingroup conflict and outgroup bias thus presenting a real threat to the solidity and integrity of the European Union as an actor of international influence. Due to the fact that many stereotypic constructs are formed on the basis of the inferiority vs. superiority distinction, inequalities and diversity in societies where people mature at their own pace could actually reinforce and perpetuate unease and disbelief. On the other hand, prejudiced attitudes can be reduced by bringing together groups in a uniform pursuit of common goals. Affiliation instead of competition is the way that will provide people with more information about themselves, their peers, their skills and competencies and lead to ingroup attraction and interdependency. The greatest difficulty for contemporary politics and global governance is to acknowledge and examine groups under this new context and not independently of the psychological situation groups have found themselves in. The construction of a new identity based on positive reinforcement and collective work could then instill the motivation to belong to the European family and to find the purpose to share and perpetuate its principles.

**Keywords:** identity, ingroup, outgroup, social comparison, leadership

## From Inclusive to Equal European Public Spheres: Bringing the Theories of Feminism and Agonistic Pluralism back in

*Aristeidis Myriskos*<sup>1</sup>

<sup>1</sup>Doctoral Researcher, Bielefeld Graduate School in History and Sociology, Bielefeld University, Germany

### Abstract

The last decade, the European Commission, in order to tackle the democratic deficit in the European Union, among other initiatives, focused on the formation of the European public sphere. The political public sphere is constituted by citizens' public debates on issues of common concern. Its aim is to further the accountability and responsiveness in institutions' decision-making process. The European Commission, in its effort to shape the European public sphere, reflected the normative liberal model of rational consensus and it highlighted the importance of the European identity and European Union's core values. Racial, ethnic, and religious groups that are not identify with the European ideals face exclusions from the European public sphere. The paper analyses these exclusions, focusing on the marginalization of Muslim immigrants and deriving its arguments from the theories of feminism and agonistic pluralism. More specifically, it retraces the late twentieth century feminist reading of Jürgen Habermas' and Hannah Arendt's works in order to suggest an alternative model of the European public sphere based on the values of agonistic pluralism. The feminist critique and the deconstruction of the normative theories deployed by Arendt and Habermas proved illuminating for the public sphere theory. Nevertheless, it was left aside in the European public sphere research. In the examination of inequalities produced in the European public sphere, the value of feminism and agonistic pluralism stems from two facts: First the theories view the rational consensus and the deliberative democracy not only as utopia but also as dangerous practice and they point to the contestational dimension of pluralism as the vital element of democracy. Second, they tend to stress the importance of politics of everyday life, the experiences and the knowledge of disadvantaged groups which are not communicated efficiently.

**Keywords:** European public sphere, deliberative democracy, rational consensus, agonistic pluralism

**Under the Auspices of H.E. the President of the Hellenic Republic,  
Mr. Prokopios Pavlopoulos**



**POLITEIA: AN  
INTERNATIONAL  
CONFERENCE  
OF POLITICAL  
SCIENTISTS**

Europe at the Crossroads:  
Leadership, Challenges  
and State of Play

**27-29 SEPTEMBER 2019  
ZAPPEION MEGARON,  
ATHENS, GREECE**



**H A P Sc**

Hellenic Association of Political Scientists

Electronic copy available at: <https://ssrn.com/abstract=3784083>

## CONTENTS

Introduction	01
Welcome Address A	02
Welcome Address B	04
About HAPSc	09
Agenda	10
Day 1	10
Day 2	13
Day 3	18
Posters	21
Conference Committee	22
Organizing Committee	23

T. (+30) 210 3645390  
E. int.conference@hapsc.org  
facebook.com/politeia.international  
www.politeia-conf.com  
facebook.com/HAPSC.ORG  
www.hapsc.org



## About “POLITEIA”

“POLITEIA” is an International Conference of Political Scientists organized, for the first time in Athens, the capital of Greece, by the Hellenic Association of Political Scientist under the Auspices of H.E. President of the Hellenic Republic, Mr. Prokopios Pavlopoulos. Upon approval, the POLITEIA Conference is included in those actions using the emblem of the United Nations Academic Impact. Bringing together researchers from all the fields of social sciences, the Conference aims to promote enriching and pluralist dialogue over various aspects of Regional, European and Global Politics.

### **Topic of 2019** “Europe at the Crossroads: Leadership, Challenges and State of Play”

The Hellenic Association of Political Scientists, aware of the multilevel challenges that the EU faces and the interdisciplinary nature of the issues that arise regarding international relations, public policies, political behavior etc. in the current social, political and economic conditions, announces the organization of the POLITEIA Conference, an International Conference of Political Scientists, on the present and future of the EU and the role of political scientists in the analysis of both the European state of play and the rising challenges. Researchers from all fields of social sciences (including political science, economics, psychology, sociology, history and social anthropology) participate, to offer interdisciplinary approaches to the topics of the Conference.

“POLITEIA” International Conference is officially supported by the European Commission (Representation in Greece) and the United Nations Regional Information Centre (UNRIC) for Greece and Cyprus, and is held with the support of the Central Union of Municipalities of Greece (KEDE).



## Welcome Address by Symeon Sidiropoulos



Dear Participants,

Through the promotion of Civil Society engagement, and by maintaining cooperation with international and national institutions, the Hellenic Association of Political Scientists (HAPSc) aims to both cultivate the critical spirit of its members and acquire a more decisive role in the formulation of political decisions. Intending to expand its constant contribution to public debates through its scientific approaches, HAPSc announces the organization of the International Conference “POLITEIA”.

Our aspiration for this conference is its formation into an interdisciplinary think tank platform, through which cooperation over current scientific and political issues will be possible. Acknowledging the multidimensional challenges that the European Union is faced with and being aware of the multidisciplinary character of those issues, the 1st (first) International Conference “POLITEIA” aims to reflect both on the European Current Affairs and the constantly increasing challenges arising in the international system.

I wholeheartedly thank all the sponsors and partners of our Conference. Their contribution was vital for the conduction of “POLITEIA”. I would like to especially thank Ms. Katerina Nafplioti Panagopoulos, the Athens Medical Group, the Hellenic Association of Entrepreneurs (EENE), the TRUE Catering, the BMW Sfaki-anakis Company, and the Antonios and Ioannis Angelicoussis Foundation. I wish you all a fruitful and productive experience.

### **Symeon Sidiropoulos**

President of the Hellenic Association of Political Scientists

President of the Organizing Committee of the International Conference “POLITEIA”



POLITEIA: AN INTERNATIONAL  
CONFERENCE OF POLITICAL SCIENTISTS

H A P Sc  
Hellenic Association of Political Scientists

Platinum Sponsor

*Katerina Nafplioti Panagopoulos*



## Welcome Address by Prof. Nikos Papadakis



Dear Participants,

I'm honored to welcome you to the "POLITEIA" International Conference, where more than 150 speakers (including Ministers, MEPs, MPs and Regional Governors, as well as Professors, Researchers and International Experts from Universities, Research Centers, Institutes and International Organizations) are participating in an open (yet structured) dialogue, mainly focused on Europe. The Conference, entitled "Europe at the Crossroads: Leadership, Challenges and State of Play", is organized around a series of topics including EU Governance and Foreign Policy, International

Relations and Politics, Sustainable Development and Energy Politics, Citizenship, Social Cohesion, Inequalities and Social Policy, Public Policies, Policy Making and Implementation, Public Administration, Labour Market(s), Regional Development and Governance, macro-Economic Policy and Financial Markets, EU response to the Refugee Crisis, EU integration and current challenges (i.e. Euroscepticism and populism), etc. The focus on Political Science combined with a structured interdisciplinary approach, provides an evidence - based framework for the multi-parametric analysis of both the European state of play and the rising challenges at the supranational, national and regional level. Allow me to congratulate the HAPSc for this important initiative and to cordially welcome, on behalf of the Scientific Committee, all the participants and guests to the POLITEIA Conference.

### **Nikos Papadakis**

Professor & Director of the Center for Political Research and Documentation  
Department of Political Science, University of Crete  
Deputy Director of the University of Crete Research Center for the Humanities, the Social and Education Sciences (UCRC)  
former Special Adviser to the European Commission  
President of the POLITEIA Conference Scientific Committee

Designed by DELUXE

# TRUE

catering



BY RADISSON BLU  
PARK HOTEL

## DEVOTED TO EVENTS OF FOOD BRILLIANCE

10 ALEXANDRAS AVE 10682 ATHENS • T. 2108894500

[www.truecatering.gr](http://www.truecatering.gr) • [info@truecatering.gr](mailto:info@truecatering.gr)

Electronic copy available at: <https://ssrn.com/abstract=3784083>



Η Ελληνική Ένωση Επιχειρηματιών ιδρύθηκε στην Αθήνα το 1987 και αποτελείται από περισσότερους από 130 δυναμικούς Έλληνες επιχειρηματίες που δραστηριοποιούνται στην ελληνική και διεθνή αγορά σ' ένα ευρύ φάσμα κλάδων.

## Ο Στόχος της ΕΕΝΕ

Στόχος της ΕΕΝΕ αποτελεί η ανάπτυξη και προαγωγή της υγιούς επιχειρηματικότητας στην Ελλάδα μέσα από ένα εποικοδομητικό και γόνιμο διάλογο με την πολιτική ηγεσία του τόπου, την κοινωνία και τους διαμορφωτές κοινής γνώμης.

## Εκδηλώσεις ΕΕΝΕ

Η ΕΕΝΕ διοργανώνει τακτικά γεύματα εργασίας και εκδηλώσεις των μελών της με μέλη της πολιτικής ηγεσίας και των πολιτικών φορέων του τόπου καθώς και των κυριότερων θεσμικών παραγόντων της χώρας, Πρέσβεις ξένων χωρών, ακαδημαϊκούς και κορυφαίους αναλυτές.

Η 6η Ετήσια Οικονομική Διάσκεψη της Ελληνικής Ένωσης Επιχειρηματιών (ΕΕΝΕ) με τίτλο «Μεγιστοποιώντας την Υπεραξία στην Ελληνική Οικονομία: Η Νέα Μέρα στην ελληνική Επιχειρηματικότητα» θα διεξαχθεί στο Ξενοδοχείο Grand Hyatt, τη Δευτέρα, 30 Σεπτεμβρίου 2019.

Η Διάσκεψη συνδιοργανώνεται με την υποστήριξη του Ελληνικού Παρατηρητηρίου του London School of Economics (LSE) και στοχεύει στο να σκιαγραφηθούν οι τρόποι, οι πολιτικές, οι πρωτοβουλίες και η στρατηγικές κατευθύνσεις μέσα από τις οποίες μπορεί να πολλαπλασιαστεί η προστιθέμενη αξία σε όλο το φάσμα της ελληνικής οικονομίας. Κεντρικά σημεία αποτελούν η παραγωγικότητα, η συνεργατικότητα, η διασυνδεσιμότητα, η ανταγωνιστικότητα, η καινοτομία, η «έρευνα & ανάπτυξη», ο ρόλος της εξωστρέφειας και η αξία διεθνών συνεργειών με στρατηγικό χαρακτήρα.

Παράλληλα, εξίσου κρίσιμη παράμετρο στην προσπάθεια αυτή αποτελεί ο ψηφιακός μετασχηματισμός και ο τρόπος που επηρεάζει το επιχειρείν και την ελληνική οικονομία – τόσο σε επίπεδο ευκαιριών, όσο και προκλήσεων. Η διάσκεψη εστιάζει επίσης στην εθνική πρόκληση του δημογραφικού, καθώς και στο θέμα του εξειδικευμένου ελληνικού ανθρώπινου δυναμικού και τους τρόπους με τους οποίους μπορεί να κεφαλαιοποιηθεί με το μέγιστο δυνατό όφελος στην χώρα μας σήμερα.

Για περισσότερες πληροφορίες για την Ένωση:

210 728 9000 | [eene.gr](http://eene.gr)

Electronic copy available at: <https://ssrn.com/abstract=3784083>



Sheer  
Driving Pleasure



# ΝΕΑ BMW X1.

Η νέα BMW X1 φέρνει την περιπέτεια στην compact premium SAV κατηγορία, καθώς συνδυάζει ευρυχωρία, άνεση και δυναμικό ενθουσιασμό. Με νέα, πλούσια πακέτα εξοπλισμού που περιλαμβάνουν μεταξύ άλλων, σύστημα πλοήγησης και Apple CarPlay. Αποκτήστε τη νέα BMW X1 που σας ταιριάζει.

από **€259\*** / μήνα με το πρόγραμμα **BMW All Inclusive** ή

από **€347,23\*\*** / μήνα (πλέον ΦΠΑ) με το πρόγραμμα **BMW Leasing**

## ΣΦΑΚΙΑΝΑΚΗΣ ΑΕ

Λ. Κηφισίας 53, 15123 Μαρούσι

210 6194500

[www.bmw-sfakianakis.gr](http://www.bmw-sfakianakis.gr)

\*Η μηνιαία δόση έχει υπολογιστεί για το μοντέλο BMW X1 sDrive 18i με το πρόγραμμα BMW ALL INCLUSIVE της BMW Financial Services με αξία οχήματος €31.645, προκαταβολή €11.980, ετήσιο ονομαστικό επιτόκιο 4,9%, πλέον εισφοράς 0,6% Ν. 128/75, διάρκεια 48 μήνες, τελευταία μεγάλη δόση €13.607, άποκη χρηματοδοτούμενη ασφάλεια (Top Cover) €2.157, άποκη προστασία δανείου €495, έξοδα φακέλου €280, συνολικό ποσό πίστωσης €22.317, συνολικό ποσό καταβολής €38.275, και ΣΕΠΠΕ 6,03%.

\*\*Οι προνομιακοί όροι μίσθωσης για το μοντέλο BMW X1 sDrive 18i με το πρόγραμμα leasing BMW Free2Drive αφορούν 25% προκαταβολή, 48 μήνες διάρκειας, 20.000 χμ/μ.ετος.

copy available at: <https://ssrn.com/abstract=3784083>

## About HAPSc

The **Hellenic Association of Political Scientists (HAPSc)** was founded in 2008 by political scientists with the aspiration of creating an alternative channel for additional education beyond academic curricula. It is a Civil Scientific – Professional – Nonprofit Association and it functions according to the principles of Democracy, relying on and respecting the Greek Constitution and the Laws of the Greek State. Furthermore, HAPSc embraces the principles of the United Nations – as outlined in the UN Charter –, the European Convention of Human Rights, as well as those of International Humanitarian Law as a whole.

HAPSc considers volunteerism, the advocacy of Political Science and the enhancement of the role of Political Scientists at local, regional and international level as its pillars. The Association defines the role of the Political Scientist as one that defends the need for freedom, peace, equality and respect for human life and dignity and touches upon the importance of research, development, the environment, culture and access to commodities. Since its establishment HAPSc along with its branch, HAPSc – Youth, has developed a series of multifaceted activities aiming to the guidance and support of young people of the field, who try to enter the labor market.

Encouraging participation in civil society, HAPSc maintains cooperation with international and national institutions and intends both to cultivate the critical spirit of its members and to acquire a more decisive role in the formulation of political decisions for the protection and support of the role of young people in modern societies. HAPSc is an Association in Special Consultative Status with the United Nations Economic and Social Council (UN ECOSOC) and a Member of the United Nations Academic Impact (UNAI). HAPSc is also a member of International Political Science Association (IPSA). It remains the only representative of Greece in the International Coalition for the Responsibility to Protect (ICRtoP). HAPSc is also associated with the United Nations Department of Global Communications (UN DGC).



Hellenic Association of Political Scientists

# DAY 1: FRIDAY, 27 SEPTEMBER 2019

08:00 - 09:00

REGISTRATION

09:00 - 11:00

PLENARY SESSION  
ROOM 4 (MAIN HALL)

## EU GOVERNANCE & LEADERSHIP

**Chair: Emeritus Prof. Panagiotis Ioakimidis** (University of Athens)

The sense of “*democratic deficit*” in the European Union

**Prof. Panagiotis Liargovas (Jean Monnet Professor)**, University of the Peloponnese), **Dr. Christos Papageorgiou** (University of the Peloponnese)

*Policy making and implementation in times of crisis from a public governance perspective: The cases of Cyprus, Greece, Ireland and Portugal*

**Dr. Panos Liverakos** (Team Leader UNDESA/UNDP)

*EU prospects in the new institutional 5-year cycle*

**Emeritus Prof. Panagiotis Ioakimidis** (University of Athens)

*The Liberalization of Europe*

**Assistant Prof. Panagiotis Evangelopoulos** (University of the Peloponnese)

*Leadership in Europe: remarks on good and bad leadership*

**Associate Prof. Manos Papazoglou** (University of the Peloponnese)

*On the European tug-of-war between Democracy and Technocracy*

**Dr. Sotiris Mitralaxis** (Teaching Fellow at the National and Kapodistrian University of Athens and Research Fellow at the University of Winchester)

11:00 - 11:30

COFFEE BREAK / CHECK-IN FOR THE NEXT SESSION

11:30 - 13:30

PLENARY SESSION  
ROOM 4 (MAIN HALL)

## EU FOREIGN POLICY

**Chair: Prof. Aristotle Tziampiris** (Chair of the Department of International and European Studies, University of Piraeus)

*Is there an EU policy for the security in the Eastern Mediterranean?*

**Prof. Angelos Syrigos** (Panteion University, MP in the Greek Parliament)

*Is foreign policy the most important public policy?*

**Prof. Konstantinos A. Lavdas** (Panteion University)

*Realpolitik in EU-Turkey relations?*

**Dr. Constantinos Filis** (Executive Director of the Institute of International Relations, Panteion University)

*Greece in the “New” Eastern Mediterranean*

**Prof. Aristotle Tziampiris** (Chair of the Department of International and European Studies, University of Piraeus)

*Cultural Diplomacy in Greece: the role of National Commission for UNESCO*

**Dr. Giannis Manolis** (HNC UNESCO)

13:30 - 14:30

LIGHT LUNCH / CHECK-IN FOR THE NEXT SESSION

14:30 – 16:00	<p style="text-align: center;">PLENARY SESSION ROOM 4 (MAIN HALL)</p>
	<p style="text-align: center;"><b>MARKET-DRIVEN INITIATIVES AND CULTURAL PARAMETRES</b></p> <p><b>Chair: Pavlos Efthymiou</b> (Director General, Hellenic Entrepreneurs Association/ EEENE)</p> <p><i>Infrastructure-driven development</i> <b>Ioannis Kefalogiannis MP</b> (Deputy Minister of Infrastructure, Hellenic Republic)</p> <p><i>The next day in the Hellenic entrepreneurship – initiatives for the new era</i> <b>Christianos Chatziminias</b> (Vice President, Hellenic Entrepreneurs Association/ EENE)</p> <p><i>Council on Competitiveness: The Compass for Growth</i> <b>Simos Anastasopoulos</b> (President, The Council on Competitiveness of Greece and Chairman &amp; CEO, PETSIAVAS S.A.)</p> <p><i>Europe's digital strategy &amp; future: opportunities from a growth mindset perspective</i> <b>Prof. Ioannis Pollalis</b> (University of Piraeus)</p> <p><i>Europe: A large maritime zone; The shipping sector as a driving force for development</i> <b>Prof. Evangelos Sambracos</b> (University of Piraeus)</p>
16:00 – 16:30	<p style="text-align: center;">COFFEE BREAK / CHECK-IN FOR THE NEXT SESSION</p>
16:30 – 18:30	<p style="text-align: center;">PLENARY SESSION ROOM 4 (MAIN HALL)</p>
	<p style="text-align: center;"><b>INTERNATIONAL RELATIONS &amp; POLITICS</b></p> <p><b>Chair: Prof. Konstantinos A. Lavdas</b> (Director of the International Relations Division at the Department of International, European, and Area Studies, Panteion University)</p> <p><i>Europe in the World</i> <b>MEP Nikos Androulakis</b> (Member of the European Parliament, Vice- President of the Defense Committee of the European Parliament)</p> <p><i>China's rise and Belt and Road Initiative</i> <b>Prof. Jinghan Zeng</b> (Lancaster University)</p> <p><i>Russian Soft Power in Europe and Beyond</i> <b>Associate Prof. Emmanuel Karagiannis</b> (King's College London)</p> <p><i>The European Union as an International Actor: The Western Balkan Challenge</i> <b>Associate Prof. Nikolaos Tzifakis</b> (Head of the Dept. of Political Science &amp; International Relations, University of the Peloponnese)</p> <p><i>The role of Europe in the New Turkey</i> <b>Associate Prof. Christos Teazis</b> (Ankara University)</p>
18:30 – 19:00	<p style="text-align: center;">DOORS OPEN FOR OPENING CEREMONY</p>



**Chairs: Prof. Nikos Papadakis** (Deputy Director of the University of Crete Research Center for the Humanities, the Social and Education Sciences/ UCRC & President of the Conf. Scientific Committee)

**Symeon Sidiropoulos** (University of Piraeus, President of HAPSc & President of the Conference Organizing Committee)

#### Welcome Addresses

**Dr. Panagiotis Theodorikakos** (MP, Minister of the Interior, Hellenic Republic)

**Margaritis Schinas** (European Commissioner, Vice-President of the European Commission)

**Prof. Giorgos Katrougalos** (MP, former Minister of Foreign Affairs, Hellenic Republic)

**Vice Admiral Nicolaos Tsounis HN** (Chief of the Hellenic Navy General Staff)

**Michele Siders** (Political Counselor, U.S. Embassy in Athens, Greece)

#### Speeches

*Sovereignty, Europeanism and borders: how migration is challenging concepts and patterns*

**Prof. Giovanna Campani** (University of Florence)

*Cultural distances in times of crises: How Greeks and Hungarians see themselves and others*

**Prof. Nikos Fokas** (Eötvös Loránd University of Budapest & Head of MTA-ELTE-Peripato Research Group), **Gábor Jelenfi, Róbert Tardos**

*Is Cultural Localization Education Necessary in the Epoch of Globalization? An Analysis of the Nature of State Sovereignty*

**Prof. Tien- Hui Chiang** (Distinguished Professor at the Zhengzhou University, China & Vice-President RCO4 UNESCO)

#### HAPSc Sponsors Awards Ceremony

Awards for Platinum, Gold, Silver and Bronze Sponsors  
Awards for the Supporters

#### HAPSc Special Award Ceremony

**Special Award to Honorary Professor A.-I.D. Metaxas**, Membre Titulaire de l' Academie Européenne Interdisciplinaire des Sciences, for the work: A.-I. D. Metaxas (editing- introductory texts), *“Political Science: Interdisciplinary and Cross-sectional investigation of the Political Act”* (10-volume Set Book). Athens: I. Sideris publ. & Centre for European Constitutional Law, 2016.

**HAPSc – K. Panagopoulos” 2018 Prizes Ceremony:** Best Undergraduate, Postgraduate & Doctoral Thesis

08:15 – 09:00

CHECK-IN

09:00 – 11:00

PARALLEL SESSIONS  
(ROOMS 4, 14 AND 5)

Parallel Session 1  
SUSTAINABLE DE-  
VELOPMENT,  
ENVIRONMENTAL  
AND ENERGY  
POLITICS  
Room 4

**Chair: Dr. Konstantina  
Dimitrouli** (Journalist,  
ERT)

*Energy Policy for the  
Just Transition to a  
Low-Carbon Economy*

**Prof. Raphael Heffron**  
(University of  
Dundee, Co-Chair of  
the UK Energy Law and  
Policy Association)

*Energy transition and  
climate crisis: causes  
for a new revolution*

**Prof. Asterios Pliakos**  
(Athens University of  
Economics and Busi-  
ness)

*Social Equality and  
Sustainable*

*Development: The  
Contribution of the UN  
SDSN Greece*

**Antonios Alevizos**  
(Deputy Manager, UN  
SDSN Greece)

*Sustainable Develop-  
ment & Natural Gas in  
the EU and Greece*  
**Zoi Stolaki** (Lawyer,  
Public Natural Gas Cor-  
poration [DEPA] S.A.)

*Sustainable Develop-  
ment and the European  
Union: From Policy  
Making in the Field Of  
Application*

**Dr. Zoi Karanikola**  
(University of Patras),  
**Dr. Panagiotopoulos  
Georgios** (University of  
Patras)

Parallel Session 2  
HEALTH: POLITICS  
AND POLICIES  
Room 5

**Chair: Natassa  
Spagadorou** (Journalist,  
CNN GREECE)

*Financial decision mak-  
ing in healthcare sector*

**Associate Prof.  
Athanasios Vozikis**  
(University of Piraeus)

*Patient empowerment  
and access to care: to-  
wards health democracy*

**Associate Prof. Kyriakos  
Souliotis** (University of  
the Peloponnese)

*Navigating business in  
the highly regulated  
healthcare environment*

**Fay Theiakou** (Area  
Sales Manager, Romania  
at Galenica SA)

*Ageing Population Chal-  
lenge in Primary Health  
Care - Intervention Poli-  
cies for Managing Active  
Ageing*

**Dr. Ioannis Triantafil-  
lakis** (Mayor, Xiromero),  
**Assistant Prof. Elena  
Almpani** (University of  
Patras)

*Congo: political factors  
leading to incompetence  
in facing Ebola outbreak*  
**Antonia - Nefeli  
Karaleka** (National and  
Kapodistrian University  
of Athens and Deree -  
the American College of  
Greece)

Parallel Session 3  
GOVERNANCE AND  
POLITICS IN GREECE  
Room 14

**Chair: Vasilis Pilichos**  
(University of the Pelo-  
ponnese, Deputy Scien-  
tific Director of HAPSc)

*Do we need a change of  
foreign policy?*

**George Economou** (Presi-  
dent, AHE Athens)

*Promising leadership,  
small administrations - in-  
efficient leadership, large  
administrations*

**Lampros Dimitrogiannis**  
(Vice Regional Governor,  
Western Greece)

*Crisis in Greece: A Theo-  
retical Discussion on Do-  
mestic Actors and Reform  
Environment*

**Nuve Yazgan** (University  
of Surrey)

*The Greek party sys-  
tem in crisis: From the  
ideological context to the  
pro-memorandum vs anti-  
memorandum discourse*

**Konstantina Kotsiopoulos**  
(National and Kapodis-  
trian University of Athens)

*Public governance and  
the management of  
wicked public problems*

**Dr. Maria Rammata**  
(Lecturer, University of  
Macedonia and Hellenic  
Open University)

*EU normative power and the IMO: Internal and external EU climate diplomacy*  
**George Dikaos**  
(National and Kapodistrian University of Athens)

*Bioterrorism as a Public Health Challenge: Promise vs Performance*  
**Charalampos Tsiamitas**  
(University of Malta and University of West Attica), **Dr. Tina Garani – Papadatos** (University of West Attica), **Dr. Anastasia Barbounis** (University of West Attica)

*Organizational size and IT innovation adoption: A scrutiny of the relationship between size and e-Government maturity in Greek Municipalities, through a citizen/service-oriented maturity model*  
**Michail Tsafantakis** (Leiden University)

*Digital Barometer for Public Org's and Agencies*  
**Dimitris Panopoulos**  
(Labor Market Diagnosis System)

11:00 – 11:30

COFFEE BREAK / CHECK-IN FOR THE NEXT SESSION

11:30 – 13:30

**PLENARY SESSION**  
ROOM 4 (MAIN HALL)

**REGIONAL DEVELOPMENT AND GOVERNANCE IN THE EU AND GREECE**

**Chair: Dr Anastasia Psomiadi** (Panteion University)

*Sustainable Development of the Region of Attica in the framework of EU regional development*

**Giorgos Patoulis** (Regional Governor of Attika)

*Sustainable Development Goals for Crete: Agenda 2030*

**Stavros Arnautakis** (Regional Governor of Crete)

*Structural Funds and their interaction with the statutory system in Greece*

**Fanis Spanos** (Regional Governor of Central Greece)

*The political and institutional implications of the new Multiannual Financial Framework (2021-2027) of the EU*

**Prof. Dimitrios Skiadas** (Jean Monnet ChairHolder, Head of the Department of International and European Studies, University of Macedonia)

*Regional Governance and Modularized Reskilling towards policy improvement: The case of the research project "Governance, Sustainability and Regional Innovation"*

**Dr. Maria Drakaki** (University of Crete), **Dr. Stelios Tzagkarakis** (University of Crete), **Dr. Apostolis Kamekis** (University of Crete), **Prof. Dimitris Kotroyannos** (University of Crete), **Prof. Kostas Lavdas** (Panteion University), **Prof. Nikos Papadakis** (University of Crete)

13:30 – 14:30

LIGHT LUNCH / CHECK-IN FOR THE NEXT SESSION

14:30 – 16:30	PLENARY SESSION Room 4 (Main Hall)
	<p style="text-align: center;"><b>CITIZENSHIP, SOCIAL COHESION AND INEQUALITIES</b></p> <p><b>Chair: Prof. Paraskevi Naskou-Perraki</b> (Director, Hellenic Institute on UN Affairs)  <i>The Impact of Inequality on the People and the Planet</i>  <b>Prof. Kate Pickett</b> (University of York)  <i>The enhancement of the rights of the European Citizenship - the role of the EU Court of Justice</i>  <b>Associate Prof. Despoina Anagnostopoulou (University of Macedonia)</b>  <i>Oikos, Polis, Ecumene</i>  <b>Ambassador (ret.) Alexandros P. Mallias</b>  <i>Economic inequality in the 21st century</i>  <b>Prof. Manthos Delis</b> (Montpellier Business School)  <i>Intervention - The Future of the EU's Social Dimension: Reconciling Job Quantity and Job Quality</i>  <b>Casper Gelderblom</b> (European University Institute)  <i>Intervention - Mainstreaming disability in the European Union policies: the goal for social inclusion</i>  <b>Natasa Zarkopoulou</b> (EU Policy Expert)  <i>Intervention - The European Charter of Fundamental Rights: Implementation and Future Challenges for Human Rights in Europe</i>  <b>Dr. Ioannis Tzivaras</b> (Deputy Director, Hellenic Institute on UN Affairs)</p>
16:30 – 17:00	COFFEE BREAK / CHECK-IN FOR THE NEXT SESSION
17:00 – 19:00	PLENARY SESSION Room 4 (Main Hall)
	<p style="text-align: center;"><b>EU DEFENCE AND INTERNATIONAL SECURITY</b></p> <p><b>Chair: Associate Prof. Foteini Asderaki</b> (University of Piraeus &amp; Chair of the Doctoral School on the Common Security and Defence Policy (CSDP) of the European Security and Defence College)  <i>The European Doctoral School on the Common Security and Defence Policy of the European Security and Defence College/EEAS</i> <b>Associate Prof. Foteini Asderaki</b> (Jean Monnet Professor, University of Piraeus &amp; European Security and Defence College)  <i>European Common Defense: a realistic target or an unreachable goal</i>  <b>Ambassador (ad honorem) Dimitrios Iliopoulos</b>  <i>Redefining transatlantic security relations: Europe's struggle to be strategic</i>  <b>Associate Prof. Sotiris Serbos</b> (Democritus University of Thrace)  <i>Intervention - EU – US in the East Med Security Architecture</i>  <b>General (ret.) Taxiarchis Sardelis</b>  <i>Intervention - Security policy and risk planning in uncertain times: National and European initiatives</i>  <b>Dr. Triantafyllos Karatrantos</b> (Security Policy Advisor, Ministry of Citizen Protection)  <i>The security challenges that the EU is facing in cyberspace</i>  <b>Eleni Kapsokoli</b> (University of Piraeus)</p>
19:00 – 19:15	BREAK / CHECK-IN FOR NEXT SESSION

Parallel Session 4  
MIGRATION –  
REFUGEE CRISIS AND  
EU POLICIES  
Room 4

**Chair: Dr. Theodoros Fouskas** (University of West Attica, Scientific Director of HAPSc)

*Pro- and anti-migrant mobilisations in polarised Greece: Solidarians, raid battalions, activists, and self-mobilized citizens* **Dr. Theodoros Fouskas** (University of West Attica, Scientific Director of HAPSc)

*Addressing the Needs of Migrant Mothers for Learning Greek as an Additional Language through School-Based Actions: Lessons Learned from EU Funded Initiatives* **Elena Xeni** (Aristotle University of Thessaloniki, CARDET)

*Management of the refugee crisis - reform of the existing legal framework* **Sofia Ketzetzoglou** (Auditor at the Hellenic Court of Audit)

*“CEAS before the Courts – from interpretation to standard settings”. Reflections on the Judicialization of asylum protection and the role of courts in law development* **Dr. Maria Papaioannou** (Information and Analysis Officer, EASO)

*Parents' mobilizations during the refugee crisis* **Maria Siamaga** (University of Macedonia), **Dr. George Siakas** (Research Director at the Public Opinion Research Unit, University of Macedonia Research Institute)

Parallel Session 5  
HEALTHCARE  
POLICIES  
Room 5

**Chairs: Dr. Pari Rapti** (Endocrinologist) **Associate Prof. Athanassios Vozikis** (University of Piraeus)

*Identification of the training needs of health care professionals in Greece* **Ioanna Tsantili** (University of Piraeus), **Prof. Stamatina Hadjidema** (University of Piraeus)

*Review of the medical tourism literature: a descriptive analysis of recent trends in Greece* **Dimitrios Batakis** (University of Crete), Prof. Konstantinos Zopounidis (Technical University of Crete), **Associate Prof. Athanassios Vozikis** (University of Piraeus), **Symeon Sidiropoulos** (University of Piraeus, President of HAPSc)

*Health Communication: Opportunities and Challenges* **Konstantina Briola** (Panteion University)

*Total Quality Management and leadership: a way to improve health-care services in Greece* **Dimitrios Kritas** (University of Crete), **Symeon Sidiropoulos** (University of Piraeus), **Dimitris Kakouris** (European Law and Governance School)

Parallel Session 6  
ISSUES OF ENERGY  
AND SUSTAINABLE  
DEVELOPMENT (ENG)  
Room 14

**Chair: Associate Prof. Emmanuel Karagiannis** (King's College London)

*Carbon pricing: recent developments in the European Union* **Christos Bentsos** (International Hellenic University)

*A game theoretic analysis of energy security in the Eastern Mediterranean* **Vasileios Papakostas** (University of Piraeus), **Elissavet E. Bekou** (University of Piraeus), **Prof. John A. Paravantis** (University of Piraeus)

*Energy (oil & gas) as power factor in International Politics: The “Encompassing Realism” as an exploratory and explanatory framework* **Vasileios Balafas** (University of the Peloponnese)

*The governance of local responses to global food sustainability challenges* **Associate Prof. Sevasti Chatzopoulou** (Roskilde University)

Parallel Session 7  
YOUTH ENGAGEMENT  
Room 14

**Chair: Maria Arnaoutaki** (Manager of European Affairs, HAPSc)

*Young Political Scientists* **Vangelis Spanos** (President, HAPSc Youth)

*Volunteerism and social contribution in Greece today* **Constantinos Simeoforidis** (Chief Operations Coordinator, Ethelon)

*The changing face of the Common European Asylum System: the uncertain future and challenges for refugees integration in the European Union* **Sibusisiwe Bulala Kelly** (European Law and Governance School)

*Revisiting EU Immigration and Asylum Law through global constitutionalism theory* **Danai-Georgia Koutsopoulou** (University of Hamburg)

*Refugees' social and economic integration prospects in Greece: A case study in Lesbos and Crete Islands* **Prof. Dimitrios Kotroyannos** (Director of KEADIK, University of Crete), **Dr. Stylianos Ioannis Tzagkarakis** (University of Crete), **Dr. Apostolos Kamekis** (University of Crete), **Georgia Dimari** (University of Crete), **Emmanouil Mavrozarachakis** (University of Crete)

*AIIESEC's contribution to the Sustainable Development Goals* **Ermioni Tsopto (National Director of Incoming Volunteer Operations, AIIESEC, Greece)**

*Youth engagement should be fun* **Yiorgos Nikolettakis** (Founding Member, The Tipping Point)

*The challenges of Youth Identity for the EU* **Theoharis Efthymiou-Egleton** (HAPSc under 18, Student at Stowe School, UK)

## DAY 3: SUNDAY, 29 SEPTEMBER 2019

08:45 – 09:30

CHECK-IN

09:30 – 11:30

PARALLEL SESSIONS (ROOMS 4, 14 AND 5)

Parallel Session 8  
MEDIA AND THE  
DIGITAL ERA  
Room 4

**Chair: Dr. Theodoros Fouskas** (University of West Attica, Scientific Director of HAPSc)

*How social media has changed politics* **Giannis Arbis** (Founder & CEO, Monogram)

*AI in Politics and Digital Diplomacy* **Iris Efthymiou-Eggleton** (Author, Interdisciplinary Committee at HAPSc)

*Digital: Disrupt or Disrupted* **George Anagnostopoulos** (Founder & CEO, Socialab)

*The TV commercials of the Greek Bailout referendum 2015* **Aggeliki - Flora Thanopoulou** (National and Kapodistrian

Parallel Session 9  
E-POSTERS  
PRESENTATIONS  
Room 4

**Chair: Dr. Theodoros Fouskas** (University of West Attica, Scientific Director of HAPSc) Co-chair: **Dimitrios Batakis** (University of Crete)

*European Union and the Arctic: understanding and managing a future problem* **Nikolaos Nikolaou** (MA, International and European Studies)

*Social Security, Social Welfare in Greece and Europe in the Crisis Period, 2009-2019* **Dr. Konstantinos Memos** (Panteion University)

*European policy for economic and social cohesion: Greek Community Support Frameworks - Historical comparative review* **Panagiota Seva - Agolli** (European Project Manager)

Parallel Session 10  
EU INTEGRATION,  
POLITICS AND GOVERNANCE ISSUES  
Room 5

**Chair: Associate Prof. Aris Alexopoulos** (University of Crete)

*Has the European Union democratic deficit?* **Nick Kosmadakis** (University of Crete)

*Regional Integration in the EU: the community method and the open method of coordination* **Ilektra Simitsi** (Democritus University of Thrace)

*Europe's 'Green Light': An Agambenian Approach to the Oath of Independence* **Savvas Theoulakis** (University of Piraeus)

*The multi-level Crisis of Europe* **Ioannis-Panagiotis Paraskevas** (National and Kapodistrian University of Athens), **Prof. Ruth Wodak** (Lancaster University), **Prof. Heaven Crawley** (Coventry University)

*Democracy in danger: the challenge of reshaping Europe's democracies into a more direct-democratic model* **Associate Prof. Nikolaos Koutsopoulos** (University of Macedonia), **Ioannis Mpoitsis** (University of Macedonia)

*Building the United States of Europe: Towards European Integration* **Georgios Vousinas** (National Technical University Athens)

*Strategic Management for Political Parties* **Despoina Kanta** (University of Piraeus)

Parallel Session 11  
INTERNATIONAL  
RELATIONS,  
DIPLOMACY AND  
GEOPOLITICS  
Room 14

**Chair: Prof. Ivi Mavroumoustakou** (Deputy Head of the Dept. of Political Science, University of Crete)

*USA, Europe, China: A fluid global political-economic landscape with uncertain future?* **George Athanopoulos** (Panteion University)

*A theoretical approach to the Cyprus Problem: Securitization, Neoliberalism, and Neoclassical Realism* **Dr. Nikolaos Lekakis** (University of Crete)

*The discovery of natural resources and the escalation of the Cyprus conflict: using Q-methodology to explore the disputants' perspectives on the causal mechanisms* **Vasileios Karakasis** (Leiden University)

*China's emerging role as commercial and economic partner of the EU* **Christina Meleouni** (Political Scientist - International Relations Specialist)

*The economic diplomacy of the European Union towards Western Balkans during and after the financial crisis* **Dr. Emilio Cika** (Lecturer, Mediterranean University of Albania), **Kriton Kuçi** (Mediterranean University of Albania)

	<p><i>The Greek social integration structure in the framework of European aid, evidence from the field</i> <b>Panagiota Seva - Agolli</b> (European Project Manager)</p> <p><i>Shadow economy: definitions, terms &amp; theoretical considerations</i> <b>Paraskevi Koufopoulou</b> (University of Piraeus), <b>Prof. Colin C. Williams</b> (University of Sheffield), <b>Associate Prof. Athanasios Vozikis</b> (University of Piraeus), <b>Associate Prof. Kyriakos Souliotis</b> (University of the Peloponnese)</p> <p><i>ReUp eWaste Cycling</i> <b>Anastasios Basoukis</b> (Hellenic Open University)</p>		<p><i>Cosmopolitan politics in an age of global risks: Religion as a 'soft power' agent in the EU's external policies</i> <b>Chrysa Almpani</b> (Aristotle University of Thessaloniki)</p> <p><i>Peace in the eyes of the beholder: How the UN Security Council perceives Sustainable Development Goal 16</i> <b>Georgia Apostolaki</b> (Researcher, Hellenic Institute on United Nations Affairs &amp; Coordinator, Europe Direct Informational Centre)</p> <p><i>EU Geopolitics in Southeastern Mediterranean</i> <b>Christos Argyriou</b> (International Relations Specialist)</p>
11:30 – 12:00	COFFEE BREAK / CHECK-IN FOR THE NEXT SESSION		
12:00 – 14:00	PLENARY SESSION Room 4 (Main Hall)		
	<p style="text-align: center;"><b>PUBLIC POLICIES IN EDUCATION, HIGHER EDUCATION &amp; TRAINING</b></p> <p><b>Chair: Prof. Theodore Chadjipadelis</b> (former Head of the Department of Political Sciences, Aristotle University of Thessaloniki)</p> <p><i>Higher Education Policy and the quest for Academic Excellence.</i> <b>Prof. Odysseas Zoras</b> (Rector of the University of Crete)</p> <p><i>Research and innovation strategies for the University of the future</i> <b>Prof. Panagiotis Tzionas</b> (Vice Rector for Research and Lifelong Learning, International Hellenic University)</p> <p><i>The current EU Education and Training Policy, the changing labour market and the key challenges to EU's social cohesion.</i> <b>Prof. Nikos Papadakis</b> ((Deputy Director of the University of Crete Research Center for the Humanities, the Social and Education Sciences/ UCRC)</p> <p><i>European Governance in Education: Policy Learning Through Projectization and the New Competences for the European Teacher</i> <b>Prof. George Pasiadis</b> (National and Kapodistrian University of Athens), <b>Antonia Samara</b> (Headteacher, Marasilion Experimental Multigrade Primary School of the University of Athens)</p> <p><i>Regime complexity and SDG4 for Quality Education: the EU's strategic response</i> <b>Associate Prof. Foteini Asderaki</b> (Jean Monnet Professor, University of Piraeus &amp; European Security <b>Vera Dilari</b> (Education Expert, University of Piraeus)</p> <p><i>Intervention - Greece as an international hub for Higher Education</i> <b>Cheryl Novak</b> (Expert in the European Higher Education System)</p>		
14:00 – 15:00	LIGHT LUNCH / CHECK-IN FOR THE NEXT SESSION		



15:00 – 17:00	<b>PLENARY SESSION</b> Room 4 (Main Hall)		
	<p align="center"><b>PUBLIC ADMINISTRATION, POLICY-MAKING AND GOVERNANCE</b></p> <p><b>Chair: Prof. Manthos Delis</b> (Montpellier Business School)</p> <p><i>What was really the case? The analysis of 2019 elections in Greece</i>  <b>Prof. Theodore Chadjipadelis</b> (former Head of the Department of Political Sciences, Head and Director of the MsD Program Governance-Regional Development, Aristotle University of Thessaloniki)</p> <p><i>Defeating clientelism: Lessons from public administration reform in Greece</i>  <b>Dr. Panagiotis Karkatsoulis</b> (Chairman, Institute for Regulatory Policy Research)</p> <p><i>The policy for hiring in the Greek public sector (2016-2019)</i>  <b>Prof. Ivi Mavromoustakou</b> (Deputy Head of the Dept. of Political Science, University of Crete)</p> <p><i>The policymaking in the EU and the method of Europeanization after the 2010 Eurozone crisis: problems and possibilities</i>  <b>Associate Prof. Aris Alexopoulos</b> (University of Crete)</p> <p><i>Fiscal austerity and organizational change in Greek local government: performance improvement without measurement?</i>  <b>Assistant Prof. Sifis Plimakis</b> (University of the Peloponnese)</p> <p><i>Brexit and Political Science</i>  <b>Assistant Prof. Constantinos Dikaïos</b> (Democritus University of Thrace)</p>		
17:00 – 17:30	<b>COFFEE BREAK / CHECK-IN FOR THE NEXT SESSION</b>		
17:30 – 19:30	<b>PARALLEL SESSIONS (ROOMS 4, 14 AND 5)</b>		
	<p>Parallel Session 12  <b>FINANCE AND INVESTMENTS (ENG)</b>          Room 4</p> <p><b>Chair: Dr. Alexandros Bechlioulis</b> (University of Piraeus)</p> <p><i>Financial distress indices and the contagion risk between economies</i> <b>Prof. Vasilios Sogiakas</b> (The American College of Greece-Deree)</p> <p><i>How important are capital controls in shaping R&amp;D activity?</i> <b>Dr. Alexandros Bechlioulis</b> (University of Piraeus)</p> <p><i>Peer-to-Peer Lenders' motivations and risks perceptions in cross-border investments in Europe</i> <b>Dr. Efstathios Karpouzis</b> (University of Piraeus), <b>Dr. Nikolaos Daskalakis</b> (Senior Lecturer, University of Brighton), <b>Prof. Maria Psillaki</b> (University of Piraeus), <b>Assistant Prof. Christos Staikouras</b> (Minister of Finance of the Hellenic Republic, Athens University of Economics and Business)</p>	<p>Parallel Session 13  <b>SESSION- POLITICAL ORIENTATION, POPULISM AND EUROSCEPTICISM (ENG)</b>          Room 5</p> <p><b>Chair: Dr. Panagiotis Karkatsoulis</b> (Chairman, Institute for Regulatory Policy Research)</p> <p><i>Financial literacy and political attitudes</i> <b>Prof. Georgios Panos</b> (University of Glasgow)</p> <p><i>Citizens' financial literacy as a shield against populism</i> <b>Prof. Nikolaos Filippas</b> (University of Piraeus)</p> <p><i>Brexit: A mistake or an opportunity?</i> <b>Prof. Dimitrios Gounopoulos</b> (University of Bath)</p> <p><i>Populism in the birth-place of Democracy: The peculiar case of Greece</i> <b>Assistant Prof. Spyridon Plakoudas</b> (Rabdan Academy)</p> <p><i>Conceptual and empirical analysis of modern euroscepticism: The cases of France, United Kingdom and Italy</i> <b>George Nastos</b> (University of Crete)</p>	<p>Parallel Session 14  <b>ISSUES OF EDUCATION POLICY AND SOCIAL COHESION (ENG)</b>          Room 14</p> <p><b>Chair: Assistant Prof. Constantinos Dikaïos</b> (Democritus University of Thrace)</p> <p><i>On ethics and values in education: exploring an open educational model for ethical literacy</i> <b>Elena Xeni</b> (Aristotle University of Thessaloniki, CARDET)</p> <p><i>At the dawn of the fourth industrial revolution: challenges and opportunities of artificial intelligence in education with the aim at fostering sustainable development</i> <b>Pavlos Petidis</b> (National and Kapodistrian University of Athens)</p> <p><i>The pseudo-dilemma of autonomy versus accountability in higher education policy reforms in Greece</i> <b>Vaia Papanikolaou</b> (University of Thessaly), <b>Assistant Prof. Yannis Roussakis</b> (University of Thessaly), <b>Prof. Panagiotis Tzionas</b> (Vice Rector for Research and Lifelong Learning, International Hellenic University)</p>

*Public governance, FinTech, and Systemic Risk: One big happy (?) family* **Dr. Veni Arakelian** (Lecturer, Panteion University)

*The Political Economy of Cryptocurrencies* **Antonios Ballis** (Athens University of Economics and Business)

*Financial contagion and volatility spillover: an exploration into crude oil future market and 3Y, 4Y and 5Y CDS markets* **Konstantinos Tsiaras** (University of Ioannina)

*The challenges of forging a new policy for an inclusive religious education in Greece* **Dr. Zoe Michalopoulos** (Aristotle University of Thessaloniki)

*The need to belong as a psychological drive in the process of reaching social cohesion* **Despoina Limniotaki** (University of Kent, Liberal Alliance Steering Committee)

*From Inclusive to Equal European Public Spheres: Bringing the Theories of Feminism and Agonistic Pluralism back in* **Aristeidis Myriskos** (Bielefeld University)

19:30 - 20:00

LIGHT LUNCH / CHECK-IN FOR THE NEXT SESSION

20:00 - 20:30

CLOSING CEREMONY ROUND TABLE "EU and Greece - ROOM 4 (MAIN HALL)

**Chair: Prof. Nikos Papadakis** (University of Crete, President of the Conference Scientific Committee)

**Participants: Prof. Konstantinos A. Lavdas** (Panteion University), **Prof. Panagiotis Liargovas** (Jean Monnet Professor, University of the Peloponnese), **Prof. Theodore Chadjipadelis** (Aristotle University of Thessaloniki), **Dr. Panagiotis Karkatsoulis** (Chairman, Institute for Regulatory Policy Research), **Symeon Sidiropoulos** (University of Piraeus, President of HAPSc)

## Posters

*Uninsured healthcare coverage in Greece: KAT general hospital of Attica case* **Paraskevi Koufopoulou** (University of Piraeus), **Grigoria Betsi** (Hellenic Open University), **Associate Prof. Athanassios Vozikis** (University of Piraeus), **Associate Prof. Kyriakos Souliotis** (University of the Peloponnese)

*Out of pocket payments in Greece & chronic diseases in crisis era: diabetes mellitus case* **Paraskevi Koufopoulou** (University of Piraeus), **Dr. Ioannis Kyriazis** (KAT General Hospital of Attica), **Associate Prof. Athanassios Vozikis** (University of Piraeus), **Associate Prof. Kyriakos Souliotis** (University of the Peloponnese)

*Towards a United Europe: The case of the German Unification* **Dimitrios - Michalis Tritsetakis** (Panteion University)

*The Greek social integration structure in the framework of European aid, evidence from the field* **Panagiota Seva - Agolli** (European Project Manager)

*European policy for economic and social cohesion: Greek Community Support Frameworks - Historical comparative review* **Panagiota Seva - Agolli** (European Project Manager)

*Citizenship in a hypothetical European Federal State. Can the European society and the public administration handle and solve this situation as a Federal State?* **Aristeidis Velonis** (University of Macedonia)

*Carbon pricing: recent developments in the European Union* **Christos Bentsos** (International Hellenic University)

*EU normative power and the IMO: Internal and external EU climate diplomacy* **George Dikaos** (National and Kapodistrian University of Athens)

*A game theoretic analysis of energy security in the Eastern Mediterranean* **Vasileios Papakostas** (University of Piraeus), **Elissavet E. Bekou** (University of Piraeus), **Prof. John A. Paravantis** (University of Piraeus)

*Bioterrorism as a Public Health Challenge: Promise vs Performance* **Charalampos Tsiamitas** (University of Malta and University of West Attica), **Dr. Tina Garani - Papadatos** (University of West Attica), **Dr. Anastasia Barbounis** (University of West Attica)

*Health Communication: Opportunities and Challenges* **Konstantina Briola** (Panteion University)

*The rise of populism in Europe* **Antonios Gkourlias** (University of Piraeus)

*The impact of the Eurozone crisis on the redistributive effort of the EU member-states* **Alkinoos Emmanouil-Kalos** (Hellenic Association of Political Scientists), **Elisavet Moundroulea** (Hellenic Association of Political Scientists)

## Scientific Committee

**President:** Professor Nikolaos Papadakis (University of Crete)

**Vice-President:** Associate Professor Kyriakos Souliotis (University of the Peloponnese)

**Vice-President:** Dr. Konstantina Dimitrouli (ERT)

**Vice-President:** Dr. Theodoros Fouskas (University of West Attica, Scientific Director of HAPSc)

**Honorary President:** Honorary Professor A-I. D. Metaxas, (National and Kapodistrian University of Athens & Academie Européenne Interdisciplinaire des Sciences)

**Honorary President:** Emeritus Professor Spyridon Flogaitis, (National and Kapodistrian University of Athens)

### Committee Members:

- Professor Giovanna Campani (University of Florence, Italy)
- Professor Tien-Hui Chiang (Zhengzhou University-ZZU, China)
- Professor Nikos Fokas (Eötvös Loránd University ELTE, Budapest)
- Professor Andy Green (UCL - IoE)
- Dr. Ye Liu (King's College London)
- Dr. Panos Liverakos (UNDP)
- Professor Kate Pickett (University of York)
- Emeritus Professor Stelios Chiotakis (University of Crete)
- Emeritus Professor Panagiotis Ioakeimidis (National and Kapodistrian University of Athens)
- Professor Athanasios Diamantopoulos (Panteion University)
- Professor Theodore Chadjiapadelis (Aristotle University of Thessaloniki)
- Professor Panagiotis Karkatsoulis (National School of Public Administration and Local Government)
- Professor Dimitrios Kotroyannos (University of Crete)
- Professor Kostas Lavdas (Panteion University)
- Professor Panagiotis Liargkovas (University of the Peloponnese)
- Professor Ivi Mavromoustakou (University of Crete)
- Professor Paraskevi Naskou Perraki (University of Macedonia)
- Professor Ioannis Pollalis (University of Piraeus)
- Professor Dimitrios Skiadas (University of Macedonia)
- Professor Dimitrios Xrisoxoou (National and Kapodistrian University of Athens)
- Associate Professor Aris Alexopoulos (University of Crete)
- Associate Professor Valia Aranitou (University of Crete)
- Associate Professor Stella Kyvellou (Panteion University)
- Associate Professor Manos Spyridakis (University of the Peloponnese)
- Associate Professor Nikolaos Tzifakis (University of the Peloponnese)
- Associate Professor Athanasios Vozikis (University of Piraeus)
- Assistant Professor Konstantinos Dikaos (Democritus University of Thrace)
- Dr. Ilias Pexlivanidis (EKDDA)
- Assistant Professor Sifis Plimakis (University of the Peloponnese)
- Dr. Ioannis Tzivaras (Democritus University of Thrace)
- Symeon Sidiropoulos (President of HAPSc), University of Piraeus

### Interdisciplinary Committee:

- Associate Professor Athanasios Vozikis (University of Piraeus)
- Dr. Theodoros Fouskas (University of West Attica, Scientific Director of HAPSc)
- Dr. Pari Rapti (Università degli Studi di Milano)
- Dr. Ioannis Tzivaras (Democritus University of Thrace)
- Symeon Sidiropoulos (President of HAPSc), University of Piraeus

## Organizing Committee

**President:** Symeon Sidiropoulos (President of HAPSc), University of Piraeus

### Facilitators

Eva Karamichail (University of Groningen) – Keynote Speakers Coordination  
Athanasios Venitsanopoulos (Royal Holloway University of London) – Keynote Speakers Coordination  
Elisavet Moundroulea (University of Piraeus) – Partnerships & Financial Coordination  
Leukothea Hondou (Panteion University) – Press Office  
Maria Faita (European Law and Governance School) – Public Relations Coordination  
Alkinoos Emmanouil – Kalos (Athens University of Economics & Business) – Speakers Coordination  
Maria Arnaoutaki (University College London) – HAPSc Manager of European Affairs

### Vice-Presidents

Vice-President: Philippos Sotiropoulos (National and Kapodistrian University of Athens)  
Vice-President: Athanasios Venitsanopoulos (Royal Holloway University of London)  
Vice-President: Dimitris Mpatakis, PhD can. (London School of Economics)  
Vice-President: Panagiota-Iris Efthimiou, Phd can. (University of Piraeus)  
Vice-President: Vasileios Pilichos, PhD can. (University of the Peloponnese)  
Vice-President: Foteini Theiakou (Tufts University)  
Vice-President: Dimitris Kritas, PhD can. (University of Crete)  
Vice-President: Maria Arnaoutaki (University College London) – HAPSc Manager of European Affairs

### Members

Dr. Maria Drakaki (University of Crete)  
Dr. Konstantina Dimitrouli (Panteion University)  
Dr. Prokopsis Pandis (KANEP/GSEE)  
Dr. Stelios Tsagkarakis (University of Crete)  
Dr. Vaggelis Taliouris (EAP)  
Evaggelos Spanos (European Law and Governance School)  
Dimitrios Tsaknis (European Law and Governance School)  
Maria-Gavriella Anagnostopoulou (National and Kapodistrian University of Athens)  
Stavros Tasiopoulos, PhD can. (National and Kapodistrian University of Athens)  
Antonios Gkourlias (University of Piraeus)  
Dimitrios Kakouris (European Law and Governance School)

## SPONSORS

### PLATINUM SPONSOR

*Katerina Nafplioti Panagopoulos*

### GOLD SPONSOR



**ATHENS MEDICAL  
GROUP**



### SILVER SPONSOR



Sheer  
Driving Pleasure

**SFAKIANAKIS**

### BRONZE SPONSOR



ΙΔΡΥΜΑ ΑΝΤΩΝΙΟΣ ΚΑΙ ΙΩΑΝΝΗΣ ΑΓΓΕΛΙΚΟΥΤΖΗΣ

## COMMUNICATION SPONSORS

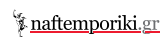

## PARTNERS

### ACADEMIC INSTITUTIONS – ACADEMIC LABORATORIES – SCIENTIFIC ASSOCIATIONS



JEAN MONNET CHAIR  
EU BUDGETARY GOVERNANCE AND AUDIT



### SOCIETIES



HALC  
HELLENIC AMERICAN  
LEADERSHIP COUNCIL



TEDx  
University of Piraeus  
A community engaged with you

### YOUTH ASSOCIATIONS



**POLITEIA 2019**



Hellenic Association of Political Scientists

Electronic copy available at: <https://ssrn.com/abstract=3784083>

ISBN:  
978-618-82982-2-4

“POLITEIA” is an International Conference of Political Scientists organized, for the first time in Athens, the capital of Greece, by the Hellenic Association of Political Scientist under the Auspices of H.E. President of the Hellenic Republic, Mr. Prokopios Pavlopoulos. Upon approval, the POLITEIA Conference is included in those actions using the emblem of the United Nations Academic Impact. Bringing together researchers from all the fields of social sciences, the Conference aims to promote enriching and pluralist dialogue over various aspects of Regional, European and Global Politics.



Hellenic Association of Political Scientists

Office Address: Voukourestiou 38 st., 10673, ATH, GR  
Administrative Basis: Charilaou Trikoupi 143 st., 11472, ATH, GR  
T. 210-3645390, email: sec@hapsc.org, www.hapsc.org